

---

## IRISMPS5 DEMO BOARD USER GUIDE

### INTRODUCTION :

The IRISMPS5 is an open frame 90W Flyback power supply unit (psu) using the IRIS4015 Integrated switcher. This demo board aims to show the capability of the IRIS4015 to handle the upper level of flyback topology power range, without the strict standby power requirement. It works with the wide range of input AC voltage (universal) and has a single output of +15V / 6amp. Switching frequency varies according to line and load condition. It operates in quasi-resonant mode ( switching current is in critically discontinuous mode) at rated capacity. This switching technique enables the internal power mosfet of IRIS4015 to switch at variable frequency with minimum switching loss.

### SPECIFICATION DATA

1. AC Input:  $V=90\sim 265V$ ,  $f=50-60Hz$ ,  
 $I_{inac}= 2.2 Arms\ max$
2. Efficiency: Typical 83% @230Vac  
measured at max. load 6 Amp (90W)
3. Switching Frequency: 40-390kHz
4. Vout : +15V nominal (14.55 – 15.45)
5. Iout : 0 - 6Amax
6. Ripple & Noise : <450mVpp
7. Hold-Up Time: 20msec (230Vin Full  
load) / 10ms (115Vin Full load)
8. Output Risetime: 15ms max @ 115Vac
9. Short Circuit Protection: Yes
10. Overvoltage Protection : Yes

---

## INPUT / OUTPUT CONNECTIONS

### Input :

CON1 : 3-PIN CONNECTOR (MIDDLE PIN IS VOID [pin 2])  
Pin 1 & 3 : AC Voltage ( 90 – 265, 50-60Hz)

### Output :

CON2 : 4-PIN CONNECTOR  
Pin 1 – 2 : ++ Positive 15V  
Pin 3 - 4 : -- Negative

**CONNECTION DIAGRAM**

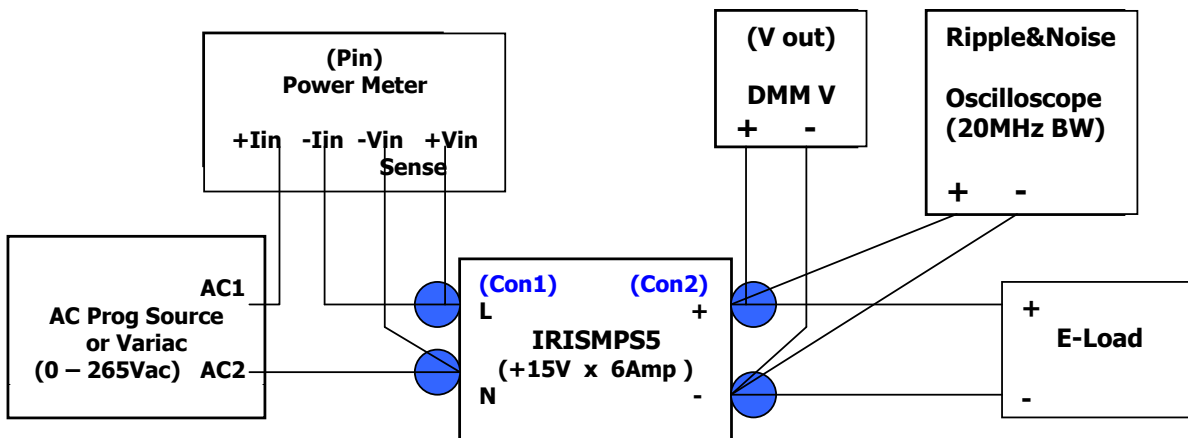
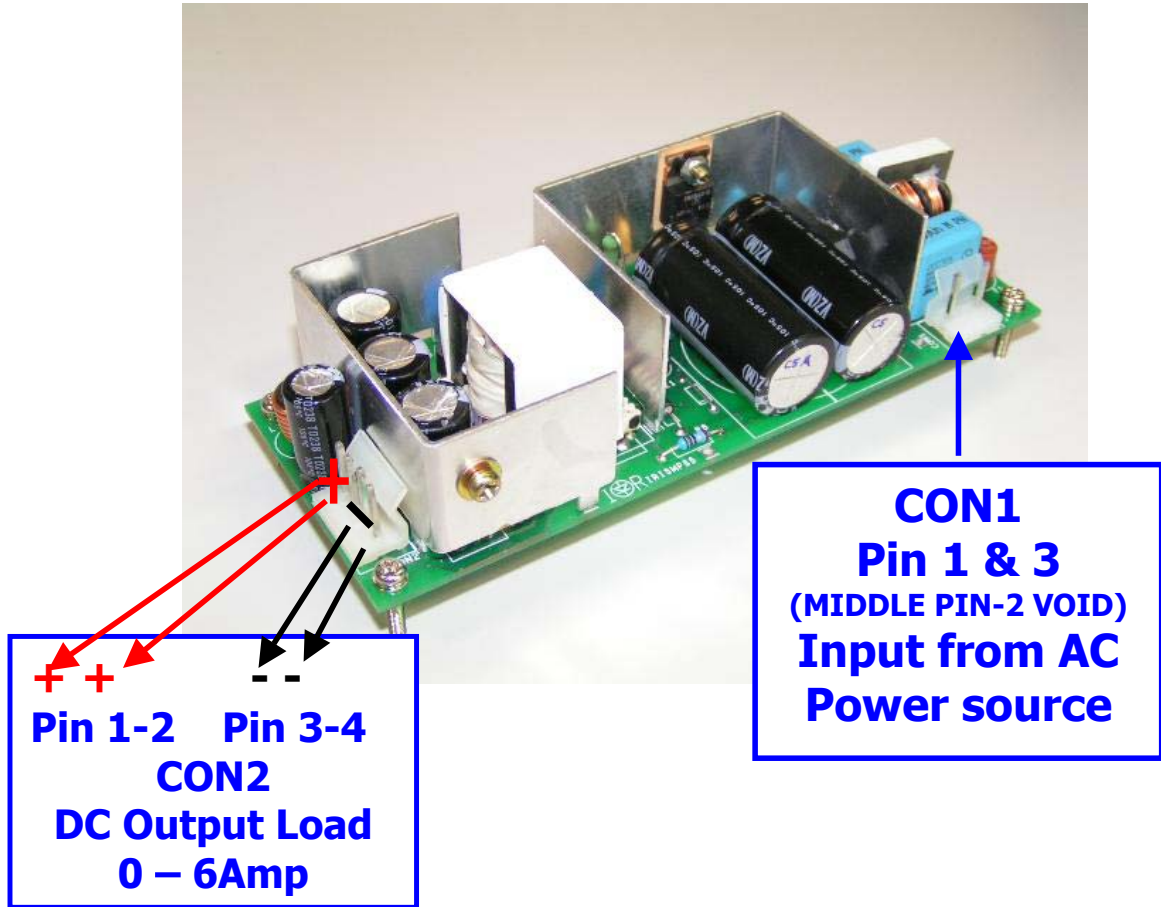

**Figure 1 : Recommended test setup**

## PHYSICAL LAYOUT

The board layout of the IRISMPS5 Demo board is shown in Figure 2. The PCB is a double-sided FR4 type ( 2oz. copper thickness).

The input of the primary section is consist of the AC input connector, fuse and EMI filter section which are located at the right side of the board, arranged in a straight forward direction.

Most parts of the primary section ( high voltage area ) are surrounded by the primary heat sink to which the IRIS4015 integrated switcher is attached with insulation pad. Primary section also includes the bridge rectifier DB1 and primary bulk cap/s (C5 or C5A//C5B) and primary side and bias winding of the power transformer.

The major parts in the secondary section are the DC output connector, pi-filter, precision reference voltage IC U2, secondary heat sink to which the output rectifier is attached with thermal grease.

The output connector is at the leftmost part of the board. The output is filtered using a pi-filter consist of low impedance e-caps C13A - C, inductor L3 and e-cap C15. A ceramic capacitor C16 is located at the backside of the board. This c-cap is positioned nearest at output connector pads to minimize switching noise.

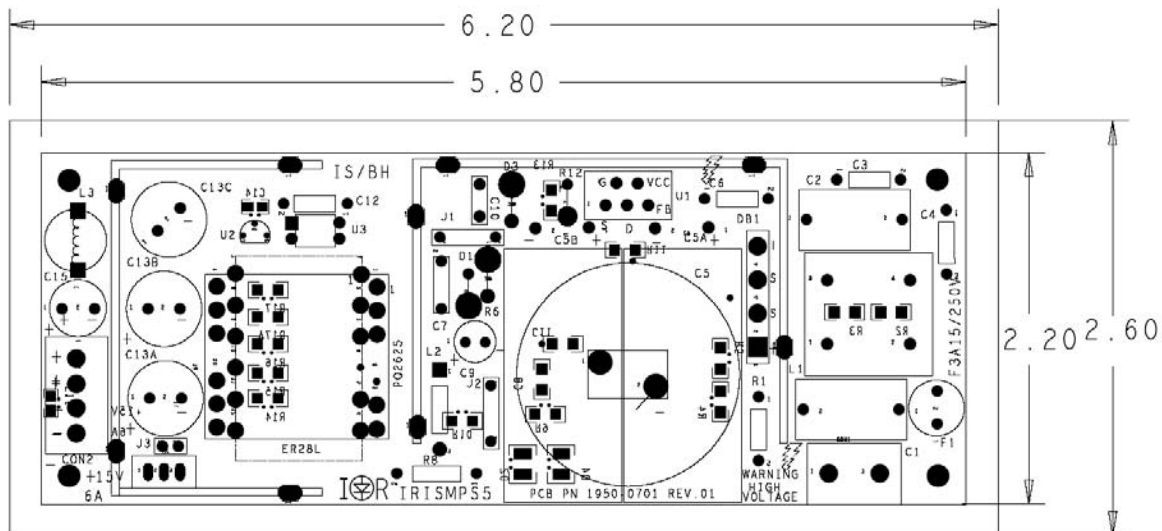
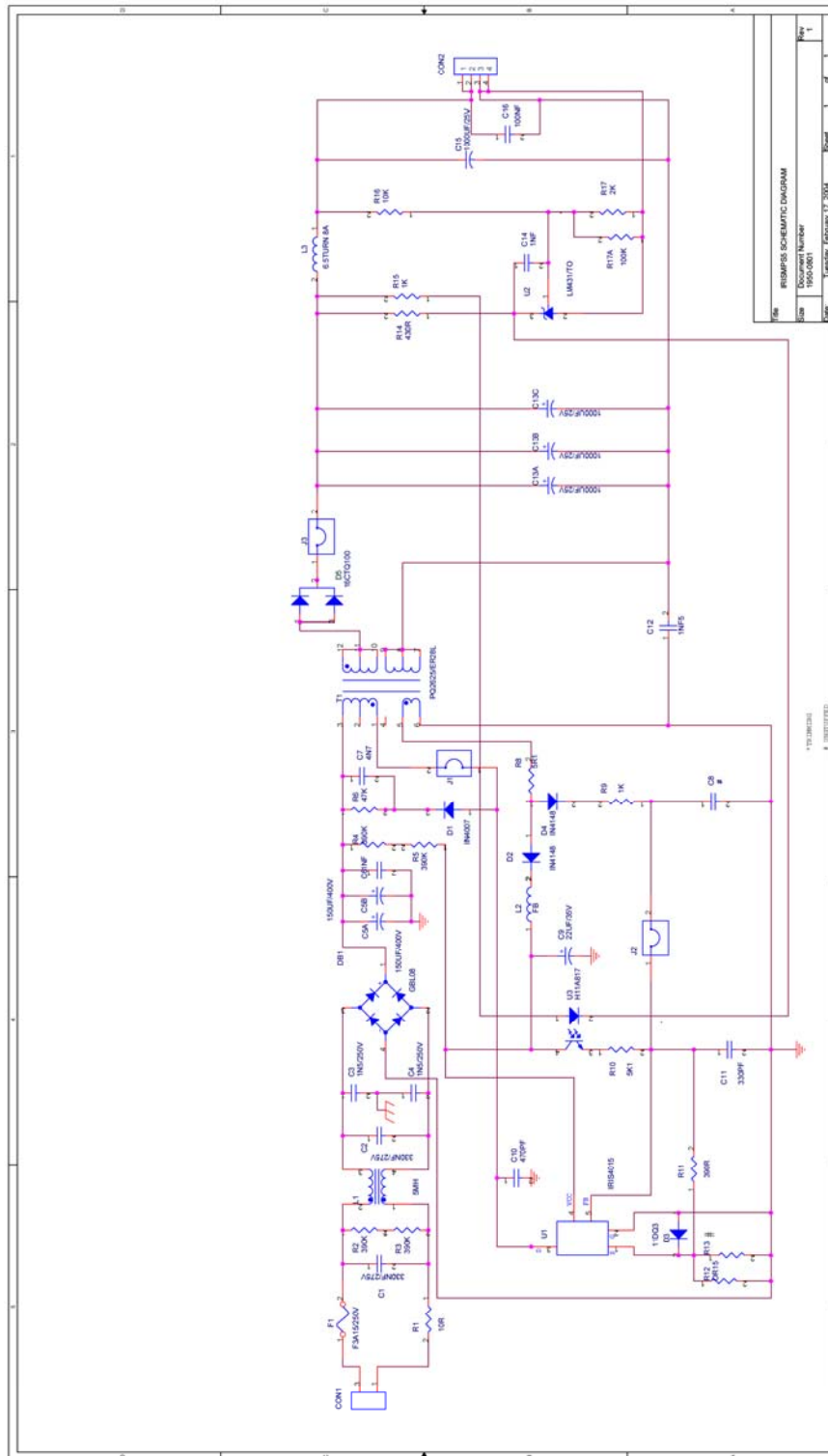

Figure 2. – Component layer of IRISMPS5 demo board with physical boundary and dimensions.

**SCHEMATIC DIAGRAM**



[www.irf.com](http://www.irf.com)

**REFERENCE DEMO BOARD**

**DOCUMENT Name : IRISMP5\_USERGUIDE\_Rev2**

**DATE : 5/28/2004**

**MODEL : IRISMP5**

**PN:1950-1001\_Rev.2**

**Page 4 of 11**

## BILL OF MATERIALS

Item	Qty	Reference	Part value	Description	Manufacturer PN	Supplier
1	1	R1	10R	NTC Thermistor 10ohm 3Amp	B57235S100M	EPCOS
		R1 alternate	10R	NTC Thermistor 10ohm 4Amp	MSP104M	MEGATOR
2	2	R2,R3	390k	1206 SMD Resistor 5%	HJW4J0394T50	ROYAL OHM
3	2	R4,R5	390k	1206 SMD Resistor 5%	HJW4J0394T50	ROYAL OHM
4	1	R6	47K	Metal Oxide Film Resistor 5% 2W	BO2SJ0473A80	ROYAL OHM
5	1	R8	22R	Carbon Film Resistor 5% 1/4W	BCW4J220JA00	ROYAL OHM
6	1	R9	150R	1206 SMD Resistor 1%	RCT06151FTP	RALEC
7	1	R10	5.1k	1206 SMD Resistor 1%	RCT06512FTP	RALEC
8	1	R12	0R15	1206 SMD Resistor 5%	SR733ALTER15J	KOA
9	1	R13		*unstuffed ( 1206 SMD Resistor 5% )		
10	1	R11	390R	1206 SMD Resistor 1%	RCT06391FTP	RALEC
11	1	R14	430R	1206 SMD Resistor 1%	RCT06431FTP	RALEC
12	1	R15	1k	1206 SMD Resistor 1%	RCT06102FTP	RALEC
13	1	R16	10k	1206 SMD Resistor 1%	RCT06103FTP	RALEC
14	1	R17	2k	1206 SMD Resistor 1%	RCT06202FTP	RALEC
15	1	R17A	100k	1206 SMD Resistor 1%	RCT06104FTP	RALEC
16	0	C1, C2 Alternate	330 nF	275VAC X2 EMI cap	KNB1560 0.33UF 10% 275 L30 R15	ISKRA
17	2	C1, C2	330 nF	275VAC X2 EMI cap	PHE840MB6330MB14R17	EVOX RIFA
18	3	C3, C4, C12	1n5	250VAC Y1 ceramic disc capacitor	KNB2520 1N5 M 250V	ISKRA
19	2	C5A, C5B	150uF	400V AluminumE-cap AXW (DxL, 18x40)	400AXW150M 18X40	RUBYCON
20		*C5 alternate	330 uF	400V E-cap MXR 35mmx35mm	400MXR330MD35	RUBYCON
21	1	*C6	1nF	500V Ceramic disc cap	XC7152KH	PANOVERSEAS
22	1	C7	4n7	2kV Ceramic disc cap	DE1105E472Z2K-SS or DEBF33D472ZN2A	MURATA
23	1	C8	330pF	1206 50V ceramic capacitor	C1206KRX7R9BB331	PHYCOMP
24	1	C9	22uF	35V Electrolytic Capacitor	TC04RKMf35VB22MF50	NCC
25	1	C10	470pF	1kV Ceramic Disc Capacitor	DEBB33A471KP2A	MURATA
26	1	C11	330pF	1206 50V ceramic capacitor	C1206KRX7R9BB331	PHYCOMP
27	3	C13A,C13B, C13C	1000uF	25V Low impedance e-cap ZL	25ZL1000MG4 12.5X25	RUBYCON
28	1	C14	10 nF	1206 50V ceramic capacitor	C1206KRX7R9BB103	PHYCOMP
29	1	C15	1000uF	25V Low impedance e-cap YXG	25YXG1000MG4 10X28	RUBYCON
30	1	C16	100nF	1206 50V ceramic capacitor	C1206KRX7R9BB104	PHYCOMP
31	1	L1	5mH	Common Mode Choke UU16 Line Filter	PG0201-3 Rev 2	Pulse Eng'g.
32	1	L2	bead	Leaded ferrite bead ( DxL : 3.5x 5mm)	RH035050ST-B	CHILISIN
33	1	L3	0.76 uH	6.5 turn 8A rod coil Inductor	PG0203	Pulse Eng'g.
34	1	DB1	4GBL08	4amp 800V Bridge rectifier diode	4GBL08	IR
35	1	D1	IN5407	3A, 600V Fast Recovery Rectifier	IN5407	PHILIPS
36	2	D2,D4	L4148	500mW Silicon Epitaxial Diode, SMD	L4148	PHILIPS
37	1	D3	11DQ03	1.1A 30V Schottky Rectifier	11DQ03	IR
38	1	D5	16CTQ100	16A, 100V Schottky Rectifier	16CTQ100	IR

www.irf.com

REFERENCE DEMO BOARD

DOCUMENT Name : IRISMPS5\_USERGUIDE\_Rev2

DATE : 5/28/2004

MODEL : IRISMPS5

PN:1950-1001\_Rev.2

Page 5 of 11

39	1	F1	3.15A	Fast Acting TR5 Sub-Miniature Fuse 250V	TR5-F NO.19370(4A)	WICKMAN
40	1	T1	PQ2625	Power Transformer 90W PQ2625 268uH Ingrid A1 Rev3	PG0202-1 Rev3	Pulse Eng'g.
41	1	U1	IRIS4015	Integrated Switcher	IRIS4015	IR
42	1	U2	H11A817	Optocoupler	H11A817B.SD	QT ELEC
43	1	U3	TL431	Precision Shunt Regulator	TL431CLP	ON SEMI
44	1			Primary Heatsink ( 1.2mm thickness Copper )	See Mechanical drawing DOC PN 1950-0601	Inhouse
45	1			Secondary Heatsink ( 1.2mm thickness Copper )	See Mechanical drawing- DOC PN 1950-0601	Inhouse
46	1			2-Sided IRISMPS5 PCB FR4 2oz	See PCB specs PN :1950- 0701	
47	1	CON1		3way -2 Straight square pin connector (middle pin void)	PN: 5417 or List No. : 39-26- 3030	Molex or equivalent
48	1	CON2		4way - 4 Straight square pin connector	PN: 5417 or List No. : 39-26- 3040	Molex or equivalent
49	1	J1		Jumper wire 0.7 diameter, 17 mm		
50	1	J2		Jumper wire 0.7 diameter, 19 mm		
51	1	J3		Jumper wire 0.7 diameter, 11mm		
52	2	for U1, D5		SCREW Countersunk M3X10 P=.5		
53	2	for U1, D5		WASHER-SPRING M3		
54	2	for U1, D5		WASHER PL M2.5 OD=6.5		
55	2	for U1, D5		HEX NUT M3X0.5X1.8 CS/NP		
56	2	for U1, D5		Plastic bushing TO-220 4mm length		
57	1	for U1		INSUL-W/D=3.6 13X19		
58				Thermal grease for D5		

TEST DATA (SAMPLE WAVEFORMS)

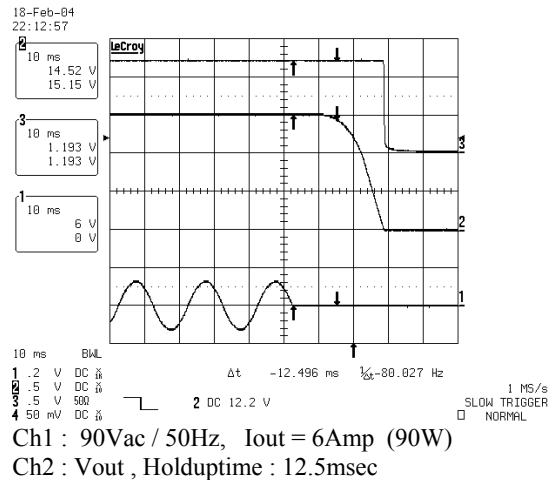
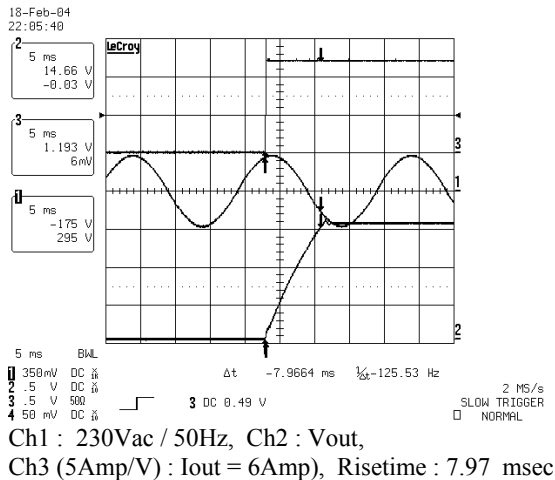
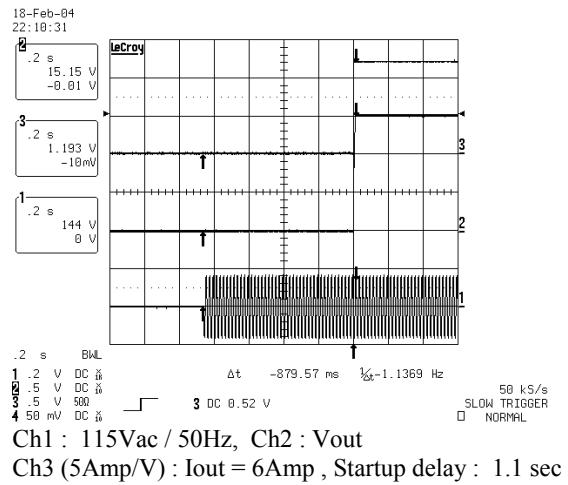
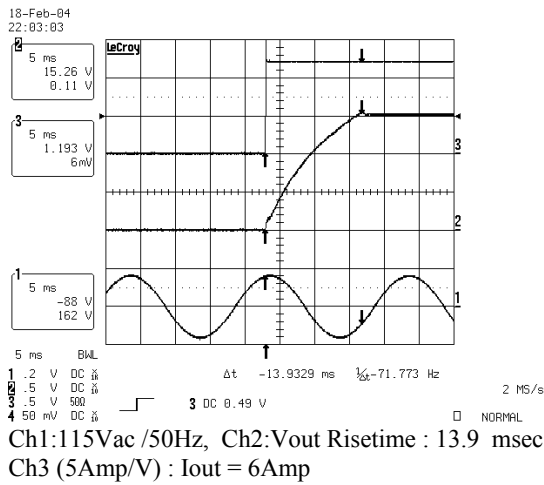
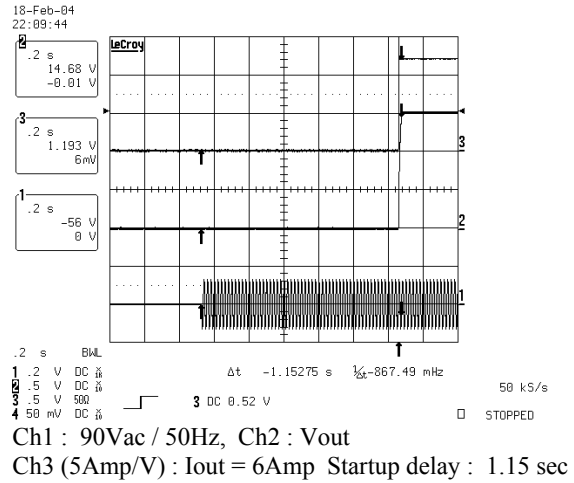
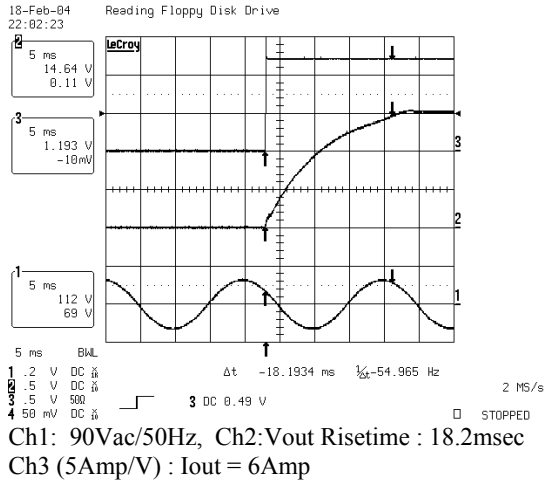

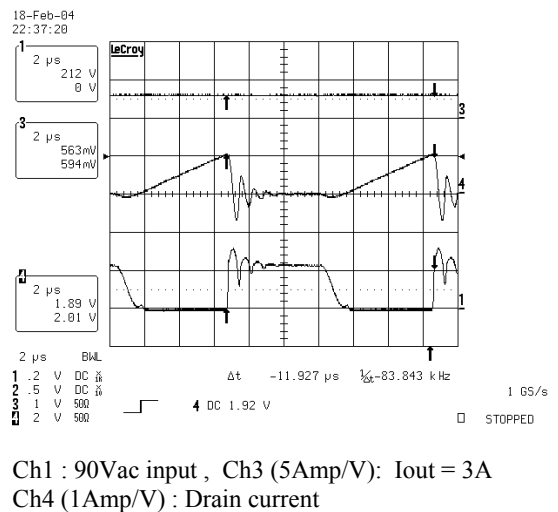
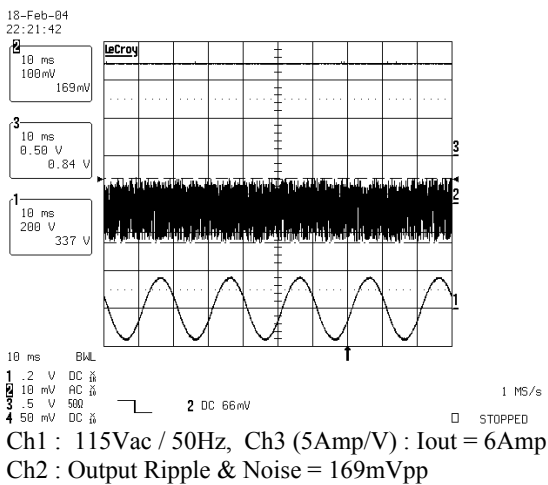
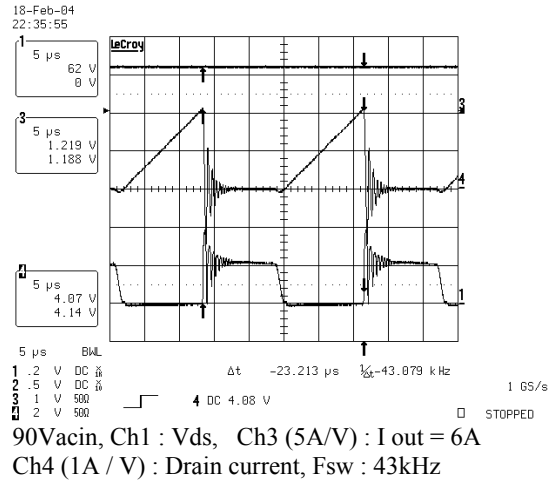
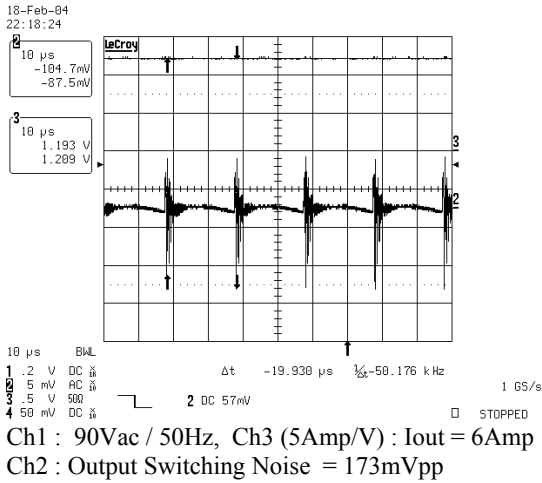
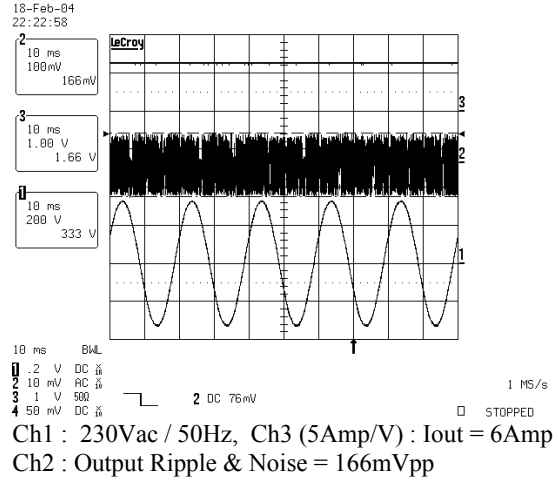
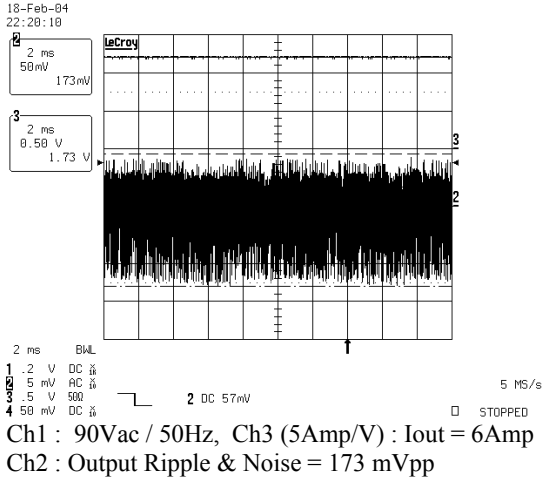



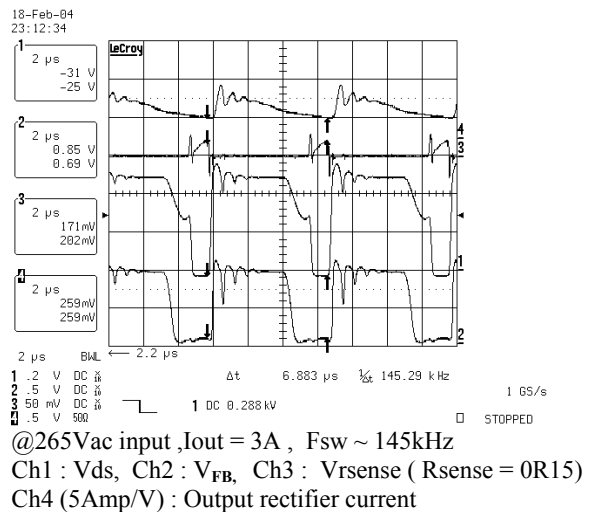
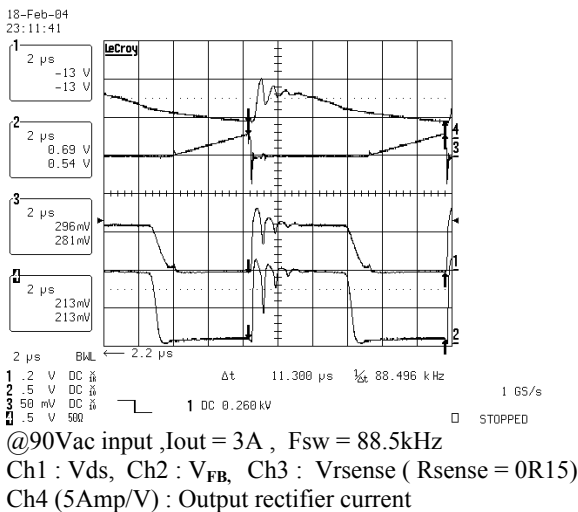
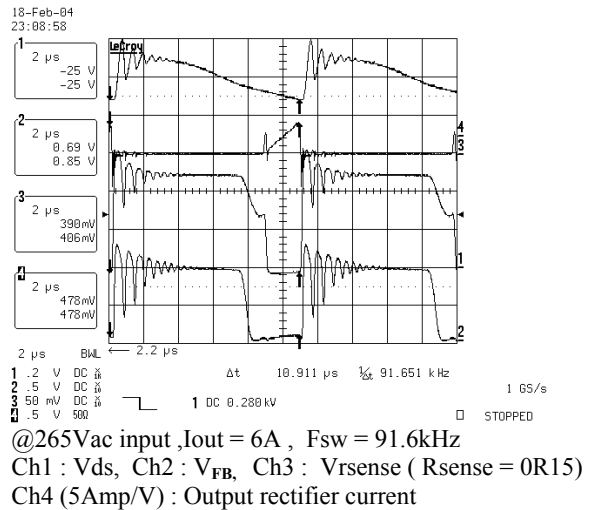
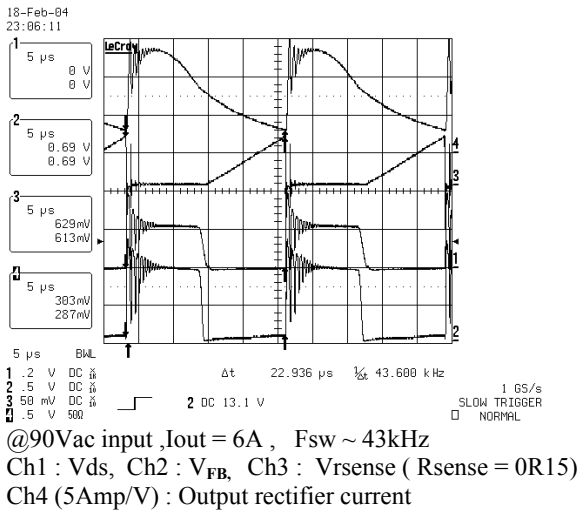
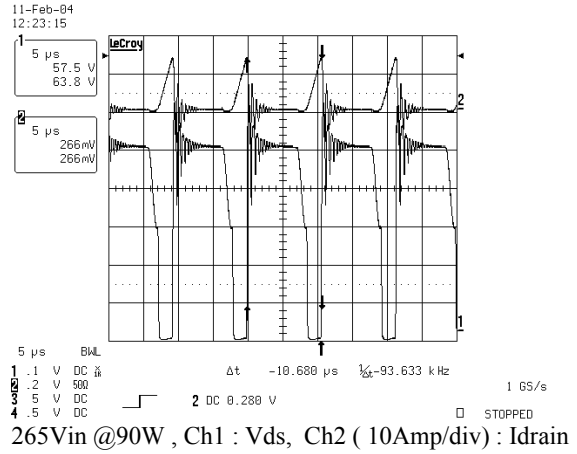
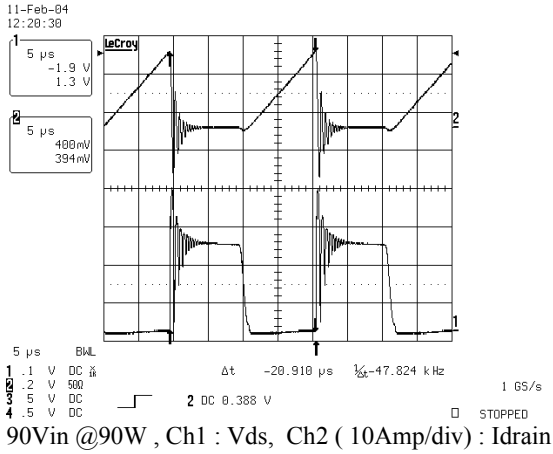

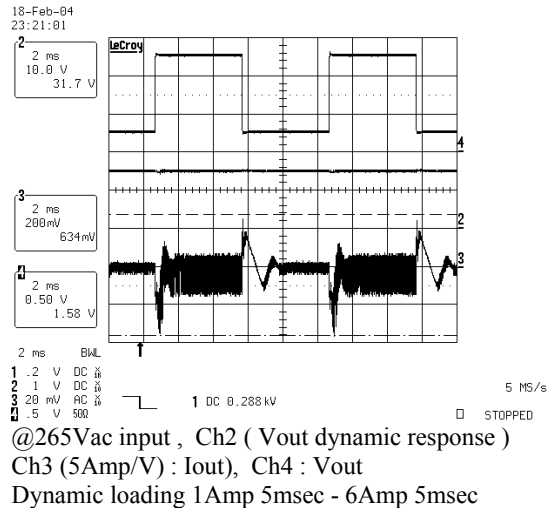
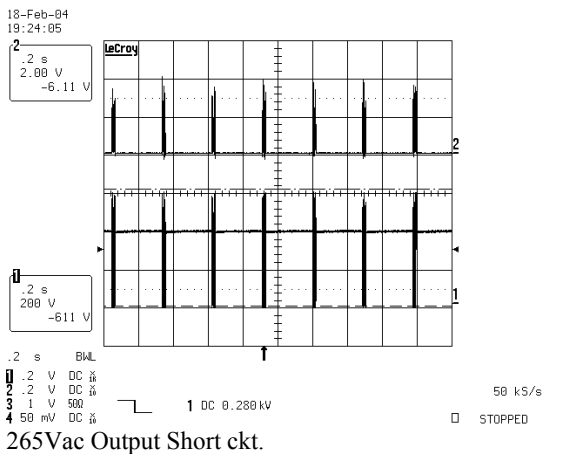
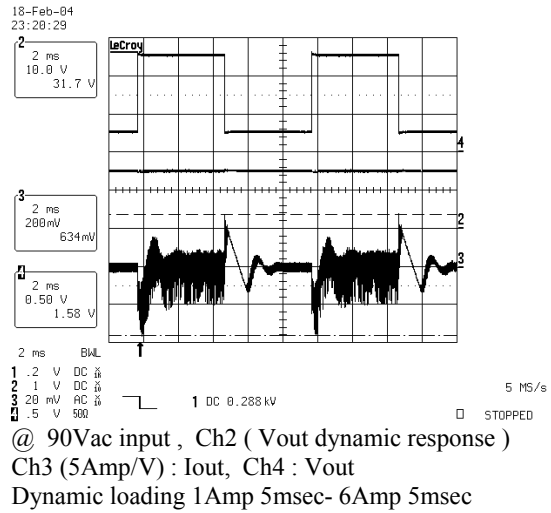
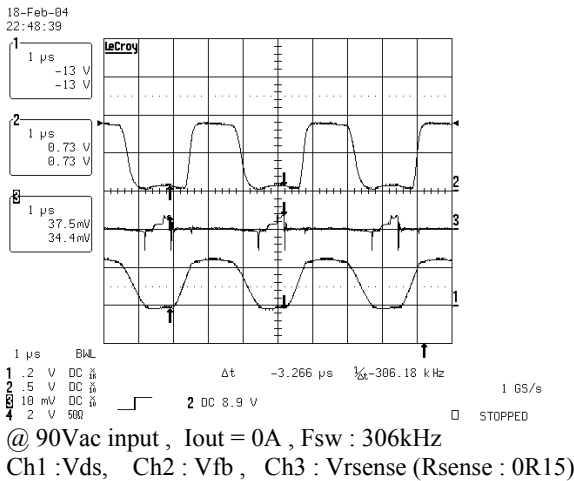
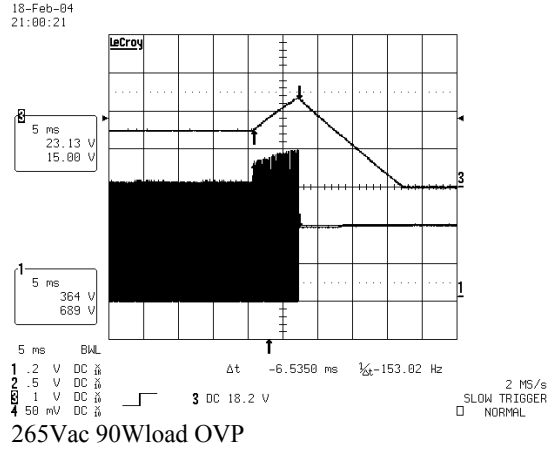
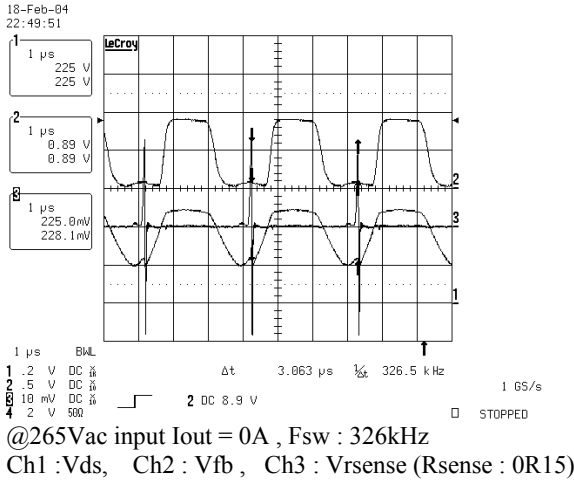

## Efficiency Graph

