

MAXIM

High Precision 10 Volt Reference

General Description

Maxim's MX581 is a three-terminal, temperature compensated, band-gap voltage reference which provides a precise 10.00V output from an unregulated input of 12.5V to 30V. Laser trimming is used to minimize initial error and temperature drift, to as low as 10mV and 15ppm/°C with the MX581.

No external components are needed to achieve full accuracy over the operating temperature range. Total supply current to the device, including the internal output buffer amplifier, is typically 750µA.

The MX581 is designed for use with 8 to 14 bit A/D and D/A converters as well as data-acquisition systems. The reference is available in a 3-pin TO-39 metal can and an 8-lead small-outline surface-mount package.

Applications

- CMOS DAC Reference
- A/D Converter Reference
- Measurement Instrumentation
- Threshold Detectors
- Precision Analog Systems

Features

- ◆ ±10mV Tolerance (MX581K)
- ◆ Low Tempco — 15ppm/°C Max. (MX581K)
- ◆ No External Components or Trims
- ◆ Short Circuit Proof
- ◆ Output Sources and Sinks Current
- ◆ 10mA Output Current
- ◆ Low Supply Current — 1.0mA Max.
- ◆ Three-Terminal Package

Ordering Information

PART	TEMP. RANGE	PIN-PACKAGE	ERROR
MX581JH	0°C to +70°C	3 TO-39 Can	±30mV
MX581KH	0°C to +70°C	3 TO-39 Can	±10mV
MX581JCSA	0°C to +70°C	8 SO	±30mV
MX581KCSA	0°C to +70°C	8 SO	±10mV
MX581JESA	-40°C to +85°C	8 SO	±30mV
MX581KESA	-40°C to +85°C	8 SO	±10mV
MX581SH	-55°C to +125°C	3 TO-39 Can	±20mV
MX581TH	-55°C to +125°C	3 TO-39 Can	±10mV
MX581UH	-55°C to +125°C	3 TO-39 Can	±5mV

Typical Operating Circuit

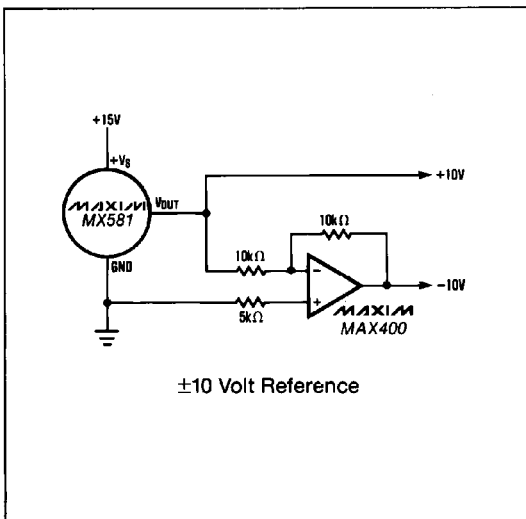

Pin Configurations

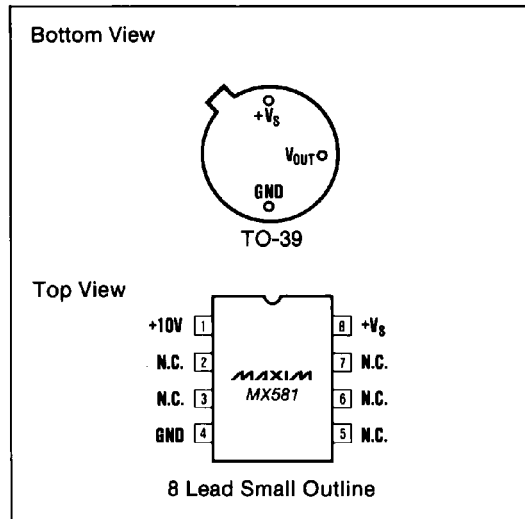

MAXIM

Maxim Integrated Products 1

Call toll free 1-800-998-8800 for free samples or literature.

High Precision 10 Volt Reference

ABSOLUTE MAXIMUM RATINGS

Input Voltage V_{IN} to GND	-0.3V, +40V	Storage Temperature Range	-65°C to +175°C
Power Dissipation		Lead Temperature (soldering, 10sec)	+300°C
TO-39 Can (derate 6.7mW/°C above +60°C)	600mW	Die Junction Temperature (T_J)	-55°C to +150°C
SO (derate 5.3mW/°C above +75°C)	400mW	Thermal Resistance, Junction to Ambient	
Output Short-Circuit Duration (Note 1)	Indefinite	TO-39 Can	150°C/W
Operating Temperature Range		SO	170°C/W
Commercial (J, K)	0°C to +70°C		
Extended (J, K)	-40°C to +85°C		
Military (S, T, U)	-55°C to +125°C		

Stresses above those listed under "Absolute Maximum Ratings" may cause permanent damage to the device. These are stress ratings only and functional operation of the device at these or any other conditions above those indicated in the operational sections of the specifications is not implied. Exposure to absolute maximum rating conditions for extended periods may affect device reliability.

ELECTRICAL CHARACTERISTICS

($V_{IN} = \pm 15V$, $T_A = +25^\circ C$, unless otherwise noted.)

PARAMETER	SYMBOL	CONDITIONS	MIN	TYP	MAX	UNITS
Output Voltage Tolerance		$I_L = 0mA$	MX581J/S		± 30	mV
			MX581K/T		± 30	
			MX581U		± 5	
Output Voltage Change with Temperature. (Temperature Coefficient)			MX581JH/JCSA		13.5 (30)	mV (ppm/°C)
			MX581JES3A		19.5 (30)	
			MX581KH/KCSA		6.75 (15)	
			MX581KESA		13 (20)	
			MX581S		30 (30)	
			MX581T		15 (15)	
			MX581U		10 (10)	
Line Regulation		No load	+12.5V < V_{IN} < +15V		0.005 (1.0)	%V (mV)
			+15V < V_{IN} < +30V		0.002 (3.0)	
Load Regulation		$I_L = 0mA$ to 5mA		20 (220)	50 (550)	ppm/mA ($\mu V/mA$)
Quiescent Supply Current	I_Q	$I_L = 0mA$		750	1000	μA
Turn-on Setting Time to 0.1%	t_{ON}			200		μs
Noise	e_{np-p}	0.1Hz to 10Hz		50		μV_{p-p}
Long-Term Stability		(Non-cumulative)		25		ppm/kHrs
Short-Circuit Current	I_{sc}			30		mA
Output Current	Source	I_L	$V_{IN} > V_{OUT} + 2.5V$	$T_A = +25^\circ C$	10	mA
				T_{MIN} to T_{MAX}	5	
	T_{MIN} to T_{MAX}			MX581J/K	5	
	T_{MIN} to T_{MAX}			MX581S/T/U	0.2	
	-55°C to +85°C			MX581S/T/U	5	
Sink						

Note 1: Absolute maximum power dissipation must not be exceeded.

High Precision 10 Volt Reference

Typical Operating Characteristics

MX581

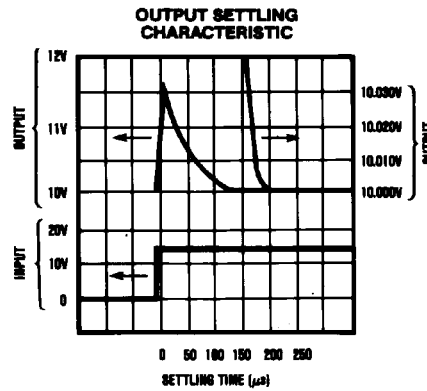
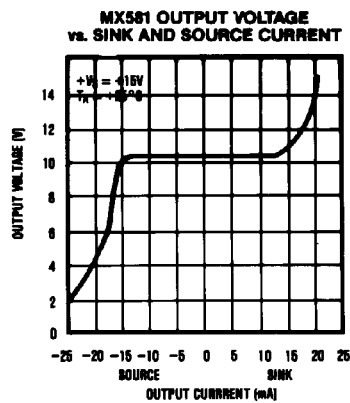
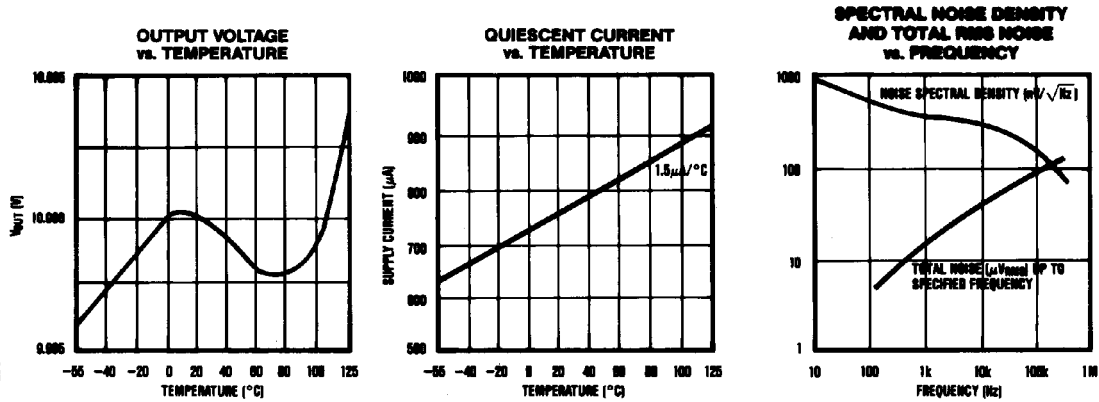

Detailed Description

As shown in Figure 1, most applications of the MX581 require no external components. Connections are $+V_S$, V_{OUT} , and GND (GND is tied to the case in the TO-5 package). Usually the desired accuracy is obtained by selecting the appropriate device grade. However, any part can be adjusted to a tighter tolerance, or to slightly different voltage, using the fine trim circuit in Figure 2. The table in Figure 2 lists the trim range for different values of R in the figure, and also shows the effect on temperature coefficient.

Voltage Temperature Coefficient

The temperature characteristic of the MX581 consistently follows an "S-curve" (see Typical Operating Characteristics). A five-point 100% test guarantees compliance with -55°C to $+125^{\circ}\text{C}$ specifications and a three-point 100% test guarantees 0°C to $+70^{\circ}\text{C}$ specifications.

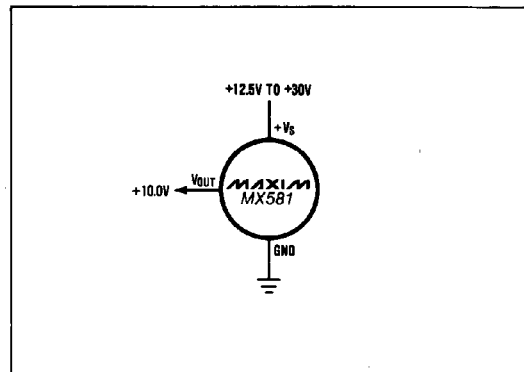

Figure 1. MX581 Basic Connection

High Precision 10 Volt Reference

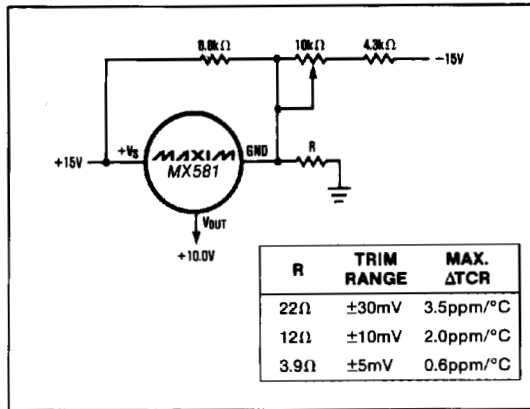

Figure 2. Optional Fine Trim Configuration

The Voltage Change specifications in the Electrical Characteristics table state the maximum deviation over temperature from the reference's initial value at 25°C, as well as drift in ppm/°C. By adding the maximum deviation for a given device to its initial tolerance, the total error is quickly determined.

Output Current

The MX581 is unique in that it can sink as well as source current. The circuit is also protected for output shorts to either +V_S or GND. The output voltage versus current characteristic is shown in the Typical Operating Characteristics section.

Dynamic Performance

The turn-on characteristics and settling performance of the MX581 are shown in the Typical Operating Characteristics. Both coarse and fine transient response is shown. The reference typically settles to 1mV within 180μs after power is applied.

Applications

Precision High Current Reference

A PNP power transistor, or Darlington, is easily connected to the MX581 to greatly increase its output current. The circuit of Figure 3 provides a +10V output at up to 4 Amps. If the load has a significant capacitive component, compensation capacitor, C1, should be added. If the load is purely resistive, high frequency supply rejection is improved without C1.

Low Input Voltage

Although line regulation is specified from 12.5V to 40V, the MX581 can operate with a +12V ±5% input by adding a resistor as shown in Figure 4. The resistor reduces the current that must be supplied from V_{OUT}. Note that the resistor cannot be used at higher input

voltages since, as the supply increases, it sources more current than V_{OUT} can sink.

Current Limiter

By adding a single resistor as shown in Figure 5, the MX581 is turned into a precision current limiter for applications where the driving voltage is 12.5V to 40V. The programmed current ranges from 0.75mA to 5mA.

Negative 10V Reference

Where a -10V reference is required, the MX581 can be connected as a two-terminal device and biased like a zener diode. The circuit is shown in Figure 6. +V_S and V_{OUT} are connected to the system's analog ground, and the MX581's GND pin is connected, through a resistor, to the negative supply. With 1mA flowing in the reference, the output voltage is typically 2mV greater than what is obtained with the conventional, positive, hook-up.

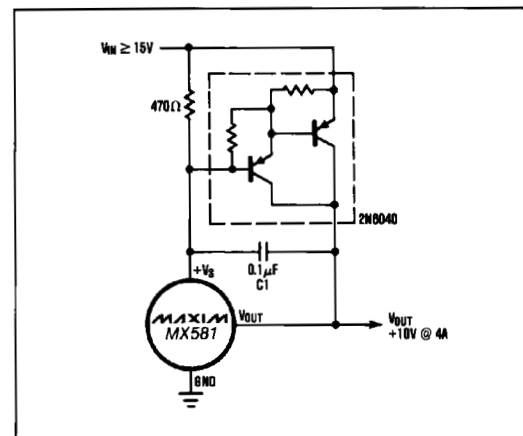

Figure 3. High Current Precision Supply

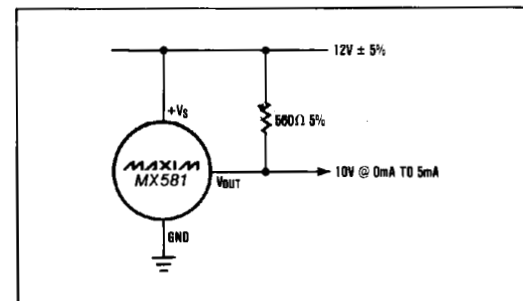

Figure 4. 12-Volt Supply Connection

High Precision 10 Volt Reference

MX581

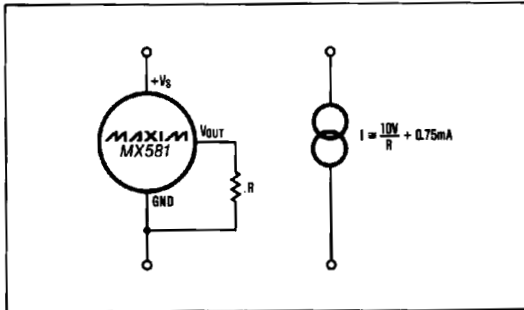

Figure 5. A Two-Component Precision Current Limiter

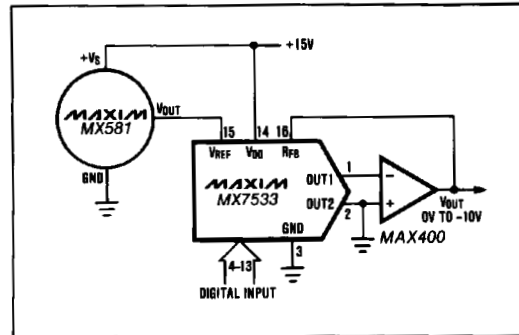

Figure 7. Low Power 10 Bit CMOS DAC Connection

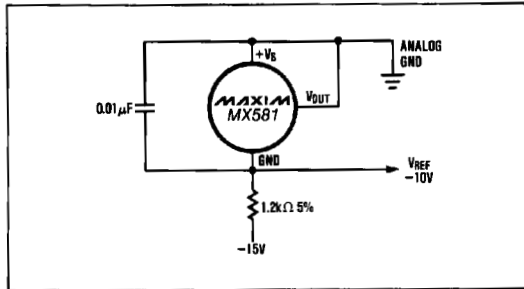

Figure 6. Two-Terminal -10 Volt Reference

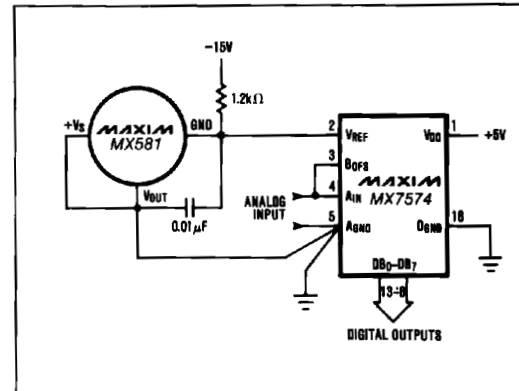

Figure 8. Negative 10V Reference for CMOS A/D Converter

When using the 2-terminal connection, the load and the bias resistor must be selected so that the current flowing in the reference is maintained between 1mA and 5mA. The operating temperature range for this connection is limited to -55° to +85°C.

Reference for CMOS DACs and ADCs

The MX581 is well suited for use with a wide variety of D-to-A converters, especially CMOS DACs. Figure 7 shows a circuit in which an MX7533 10 bit DAC outputs 0 to -10V when using a +10V reference. For a positive DAC output, the MX581 is configured as a 2-terminal -10V reference (Figure 6) and connected to the DAC's VREF input.

In Figure 8, an MX7574 CMOS A/D converter uses an MX581 for its -10V reference input. The input range for the A/D converter is 0V to +10V.

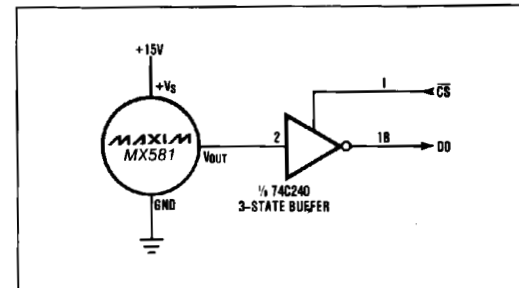
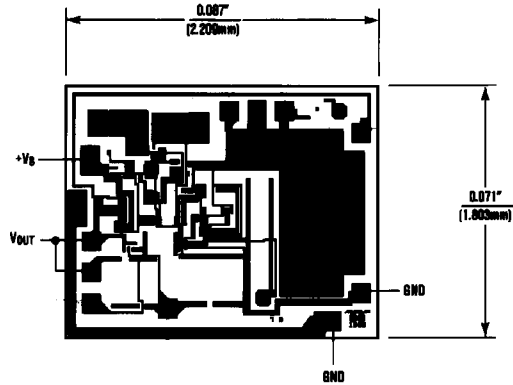

Figure 9. MX581 Microprocessor Interface

High Precision 10 Volt Reference

MX581

Chip Topography



TRANSISTOR COUNT: 72
SUBSTRATE CONNECTED TO GND

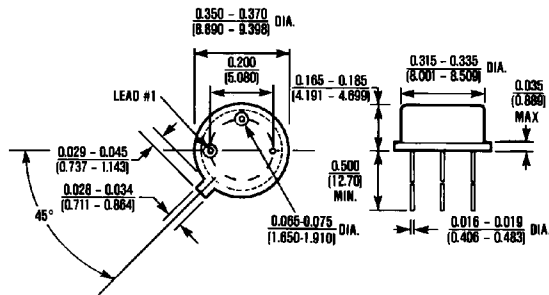

3 Lead TO-39 (VR)

$\theta_{JA} = 150^{\circ}\text{C/W}$
 $\theta_{JC} = 15^{\circ}\text{C/W}$

High Precision 10 Volt Reference

Package Information

MX581

