

**TA7641BP**  
**TA7641BF**

T-77-05-05

AM 1 CHIP RADIO

The TA7641BP is designed for the portable AM Radio applications and provides all of the functions from the converter to power amplifier. It is designed to make the quiescent current very small (1.6mA Typ. at  $V_{CC}=3V$ ) by use of the idle current control circuit. So it is capable to design the portable radio set with merit that the battery life is very long.

- Low Quiescent Current:  $I_{CCQ}=1.6mA$ (Typ.) at  $V_{CC}=3V$
- Operating Supply Voltage Range:  $V_{CC}=2\sim 5V$
- High Power Efficiency
- Power Output:  $P_o=100mW$ (Typ.) at THD=10%
- The Item is Different Each Outlines.

TA7641BP; Dual in Line Package..Outline 3D16A-P

TA7641BF; Flat Package.....Outline F16GA1-P

Unit in mm

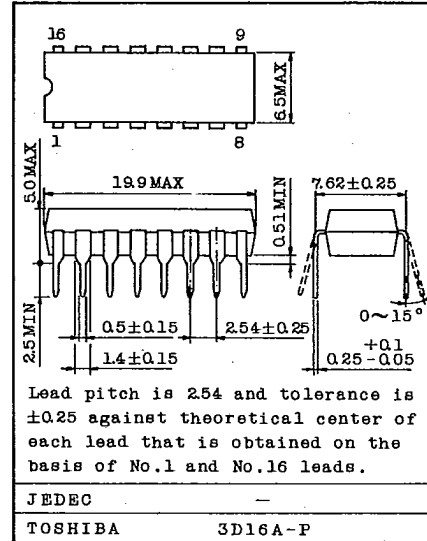

Unit in mm

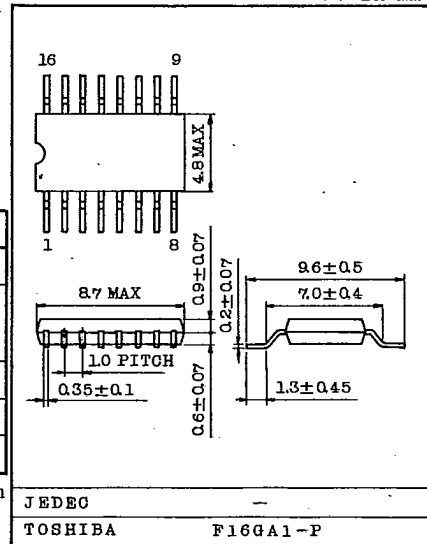

MAXIMUM RATINGS ( $T_a=25^{\circ}C$ )

CHARACTERISTIC	SYMBOL	RATING	UNIT
Supply Voltage	$V_{CC}$	6	V
Power Dissipation (Note)	TA7641BP	750	mW
	TA7641BF	350	
Output Current (Peak)	$I_O$ (peak)	0.2	A
Operating Temperature	$T_{opr}$	-10 ~ 60	$^{\circ}C$
Storage Temperature	$T_{stg}$	-55 ~ 150	$^{\circ}C$

Note: TA7641BP: Derated above  $T_a=25^{\circ}C$  in the proportion of  $6mW/^{\circ}C$ .

TA7641BF: Derated above  $T_a=25^{\circ}C$  in the proportion of  $2.8mW/^{\circ}C$ .

**TOSHIBA**

9097247 TOSHIBA. ELECTRONIC

02E 17464 D

**TA7641BP****TA7641BF**

T-77-05-05

## ELECTRICAL CHARACTERISTICS

(Unless otherwise specified,

 $V_{CC}=3V$ ,  $f=1MHz$ ,  $f_m=1kHz$ ,  $Mod=30\%$ ,  $R_g=50\Omega$ ,  $R_L=8\Omega$ ,  $T_a=25^\circ C$ )

CHARACTERISTIC	SYMBOL	TEST CIR-CUIT	TEST CONDITION	MIN.	TYP.	MAX.	UNIT
Quiescent Current	$I_{CCQ}$	1	$V_{IN}=0$	0.7	1.6	3.0	mA
Maximum Sensitivity	GSM	.1	$V_{IN}=20dB\mu V$ , $V_R=Max.$	200	-	-	mVrms
Output Power	$P_o$	1	$V_{IN}=42dB\mu V$ , $V_R=Max.$ $R_L=8\Omega$	80	100	-	mW
Maximum Output Power	$P_{OM}$	1	Power Amp. Only	-	150	-	mW
Total Harmonic Distortion	THD	1	$V_{IN}=42dB\mu V$ $V_o=200mV_{rms}$ ( $V_R=control$ )	-	2	6	%
Signal to Noise Ratio	S/N	1	( $V_R=control$ )	-	44	-	dB
Output Noise Voltage	$V_{NOISE}$	1	$V_{IN}=0$ , $V_R=Max.$	-	3.5	-	mVrms
16 Pin Parallel Input Impedance	$r_{ip}$ 16	2	$f=1MHz$	-	500	-	k $\Omega$
	$C_{ip}$ 16	2		-	2.5	-	pF
1 Pin Parallel Output Impedance	$r_{op}$ 1	3	$f=1MHz$	-	500	-	k $\Omega$
	$C_{op}$ 1	3		-	3.9	-	pF
3 Pin Parallel Input Impedance	$r_{ip}$ 3	4	$f=500kHz$	-	60	-	k $\Omega$
	$C_{ip}$ 3	4		-	2.2	-	pF
5 Pin Parallel Output Impedance	$r_{op}$ 5	5	$f=500kHz$	-	100	-	k $\Omega$
	$C_{op}$ 5	5		-	3.0	-	pF

AUDIO LINEAR IC



**TA7641BP**  
**TA7641BF**

T-77-05-05

**COIL DATA**

T<sub>1</sub> Antenna Coil

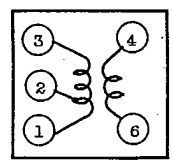

(Bottom View)

f (kHz)	L(μH)	Q <sub>0</sub>	Turns		
	1-3	1-3	1-2	2-3	4-6
300	600	115	2	130	8

TOKO  
JA-1302 or Equivalent  
Wire : 0.07mmφUEW

T<sub>2</sub> OSC Coil

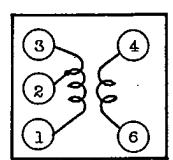

(Bottom View)

f (kHz)	L(μH)	Q <sub>0</sub>	Turns		
	1-3	1-3	1-2	2-3	4-6
796	360	125	92 $\frac{1}{2}$	8	10 $\frac{1}{2}$

SUMIDA  
0187-145-092 or Equivalent  
Wire : 0.08mmφUEW

T<sub>3</sub> AM IFT

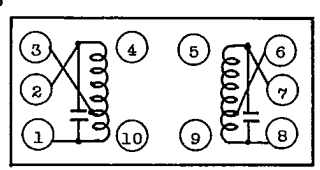

(Bottom View)

C <sub>0</sub> (pF)	f (kHz)	Q <sub>0</sub>	Turns				
			1-2	2-3	6-7	6-8	
150	150	455	65	80	148	196	32

SUMIDA  
48-037-921 or Equivalent  
Wire : 0.08mmφUEW

T<sub>4</sub> Detector Coil

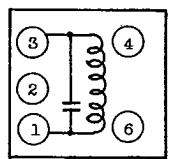

(Bottom View)

C <sub>0</sub> (pF)	f (kHz)	Q <sub>0</sub>	Turns
180	455	65	142

SUMIDA  
0130-108-016 or Equivalent  
Wire : 0.08mmφUEW

L<sub>1</sub> Bar Antenna

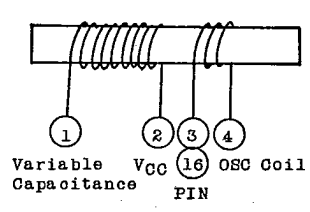

f (kHz)	L(μH)	Q <sub>0</sub>	Turns	
	1-2	1-2	1-2	3-4
796	625	200MIN	105	20

Core ; 12mmφ × 53mmφ  
Wire ; USTC-0.1mmφ

**TA7641BP**  
**TA7641BF**

T-77-05-05

TEST CIRCUIT

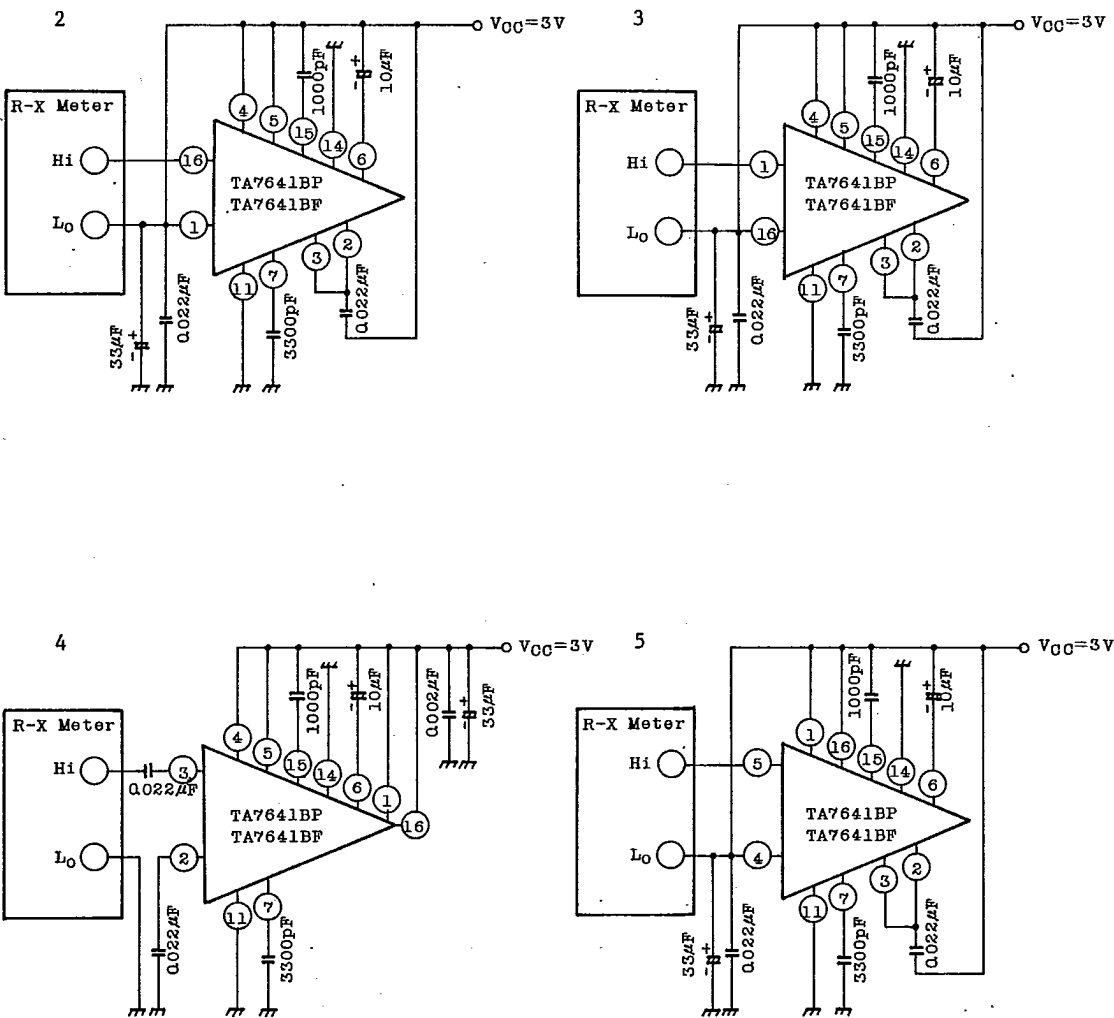

**TOSHIBA**

9097247 TOSHIBA. ELECTRONIC

02E 17468 D

TA7641BP

TA7641BF

T-77-05-05

## APPLICATION CIRCUIT

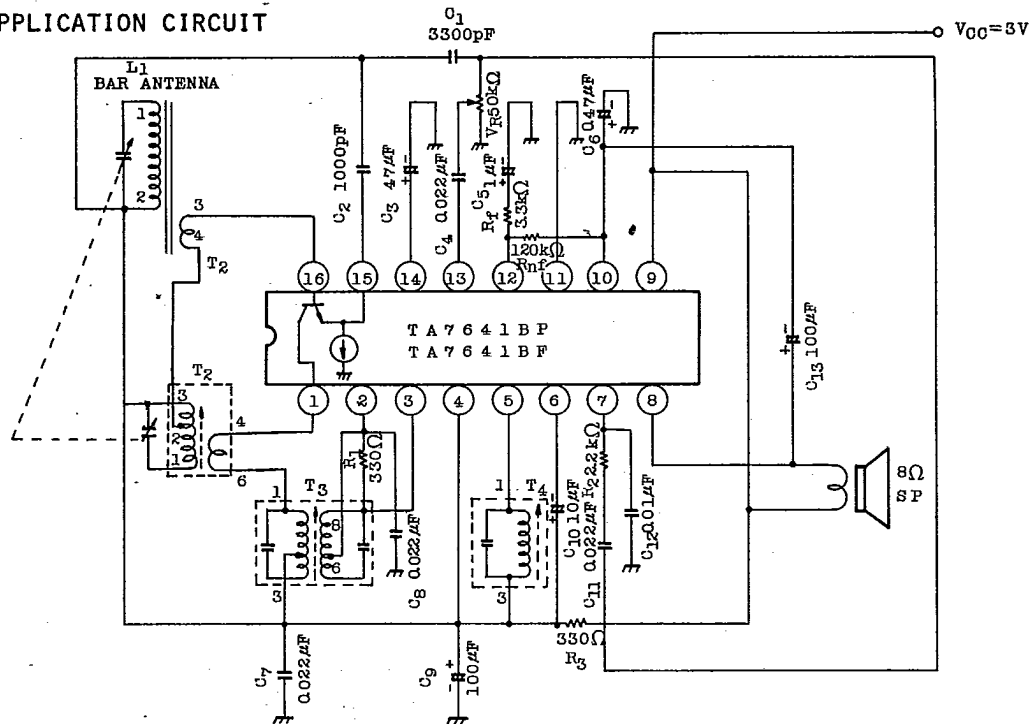

## ELECTRICAL CHARACTERISTICS

(Unless otherwise specified  $T_a=25^\circ\text{C}$ ,  $V_{CC}=3\text{V}$ ,  $f=1\text{MHz}$ ,  $f_m=1\text{kHz}$ ,  $\text{Mod.}=30\%$ ,  $R_L=8\Omega$ )

CHARACTERISTIC	SYMBOL	TEST CONDITION	TYP. VALUE	UNIT
Quiescent Current	$I_{CCQ}$	$E_{IN}=0\text{dB/m}$	1.6	mA
Maximum Sensitivity	MS	$P_O=5\text{mW}$	41	dB/m
Quieting Sensitivity	QS	$S/N=20\text{dB}$	49	dB/m
Signal to Noise Ratio	S/N	$E_{IN}=74\text{dB/m}$	44	dB
AGC Ratio (Note 1)	AGC (FOM)	-10dB Output Reduction (from 100dB/m)	50	dB
Recovered Output Voltage	VOD	$E_{IN}=74\text{dB/m}$ , Measure Pin 7	131	$\text{mV}_{\text{rms}}$
Power Amplifier Voltage Gain (Note 2)	$G_V$	$R_{nf}=120\text{k}\Omega$ , $R_f=3.3\text{k}\Omega$	26	dB
Output Power	$P_O$	THD=10%	100	mW
Total Harmonic Distortion	THD	$E_{IN}=74\text{dB/m}$	2	%

Note 1. The AGC Ratio is defined as the input electric field intensity ratio between the output voltage at 100dB/m and -10dB output voltage.

2. The open loop voltage gain of the power amplifier is typical 33dB.

AUDIO LINEAR IC

**TA7641BP**  
**TA7641BF**

T-77-05-05

$\eta - P_o$   
CHARACTERISTIC COMPARISON

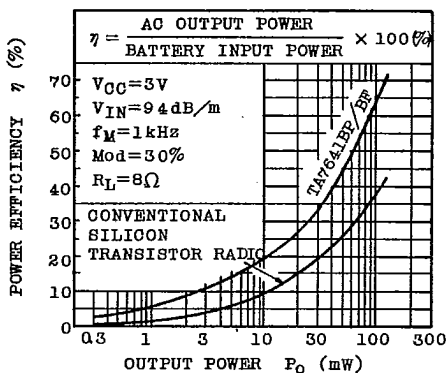

$P_D(\text{BATTERY}), I_{CC} - P_{OUT}$   
CHARACTERISTIC COMPARISON

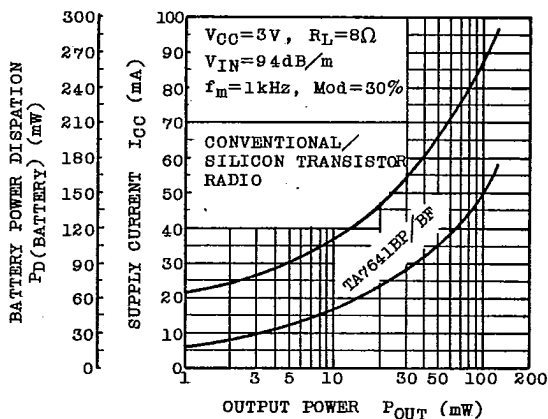

$V_{OUT}, S/N, \text{THD} - \text{EFI}$

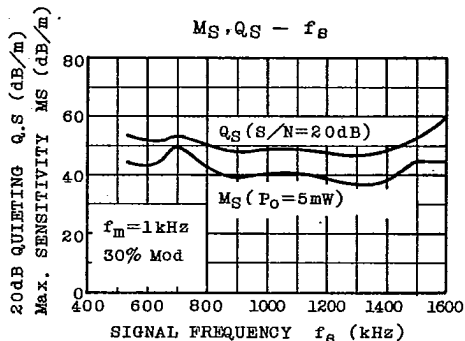
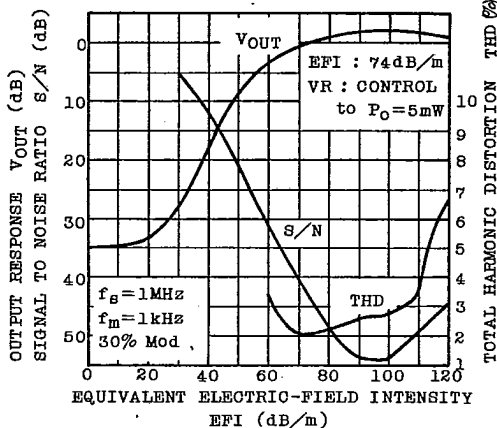

$V_{OD}, S/N, \text{THD} - \text{EFI}$

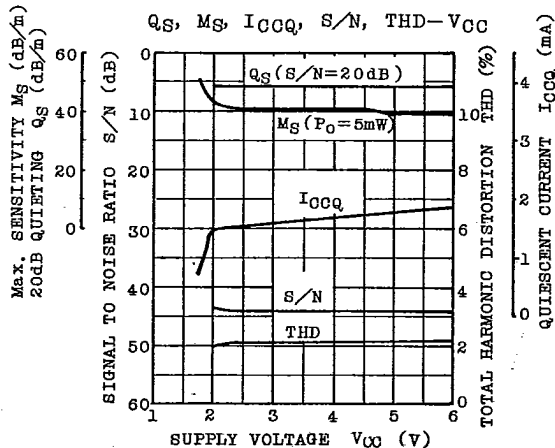
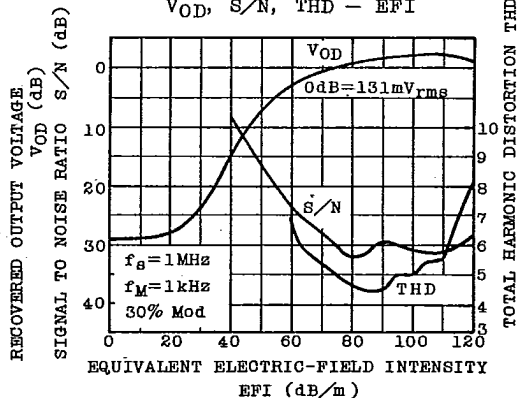

**TOSHIBA**

9097247 TOSHIBA. ELECTRONIC

02E 17470 D

**TA7641BP**  
**TA7641BF**  
T-77-05-05

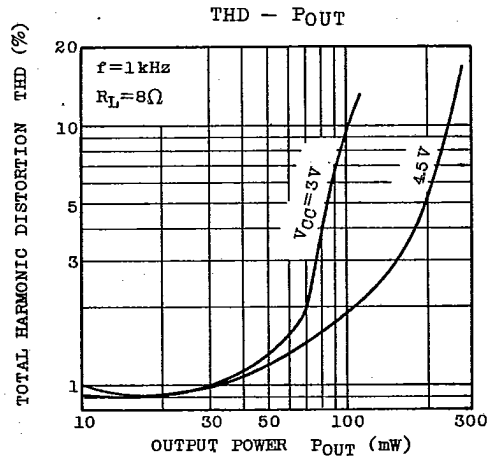
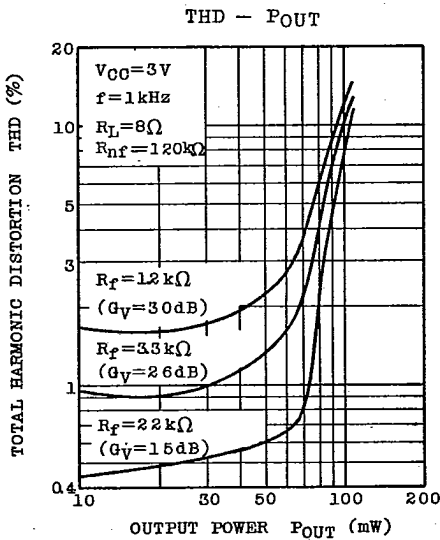
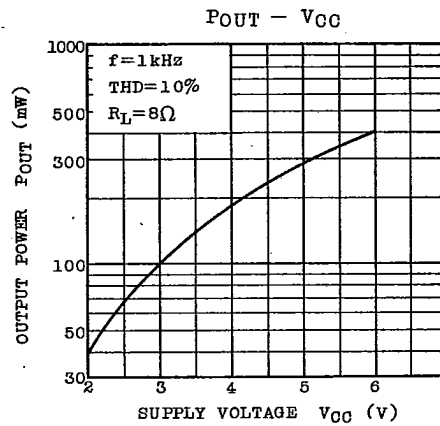
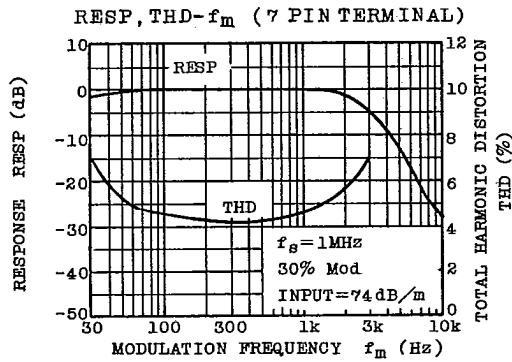
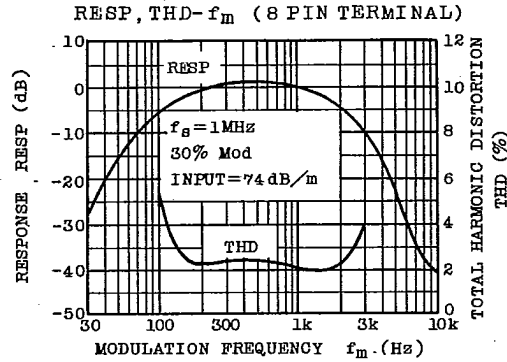
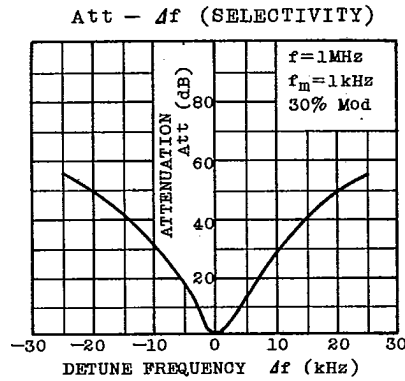

AUDIO LINEAR IC



# TA7641BP TA7641BF

T-77-05-05

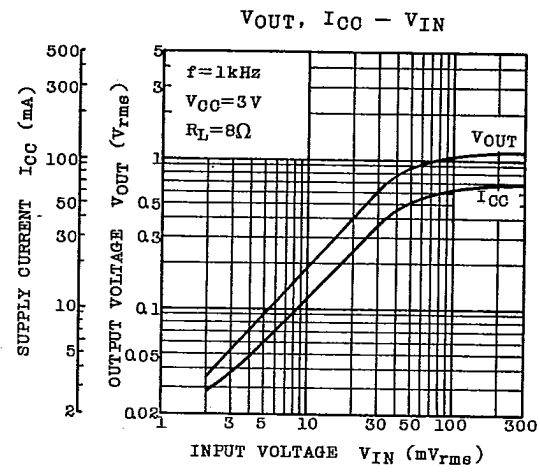
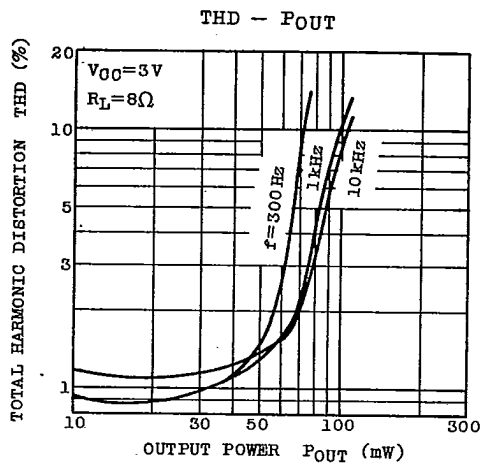

**TOSHIBA**