

### FEATURES

- ±0.5°C (typ) accuracy over temperature range
- Factory set trip points from -45°C to +15°C in 10°C increments
- Factory set trip points from +35°C to +115°C in 10°C increments
- No external components required
- Max temperature of +125°C
- Open-drain output (ADT6501/ADT6503)
- Push-pull output (ADT6502/ADT6504)
- Pin selectable hysteresis of 2°C and 10°C
- Supply current of 30 µA (typ)
- Space saving 5-lead SOT23 package

### APPLICATIONS

- Medical equipment
- Automotive
- Cell phone
- Hard disk drives
- Personal computers
- Electronic test equipment
- Domestic appliances
- Process control

### GENERAL DESCRIPTION

The ADT6501/ADT6502/ADT6503/ADT6504 are trip point temperature switches available in a 5-lead SOT23 package. It contains an internal band gap temperature sensor for local temperature sensing. When the temperature crosses the trip point setting, the logic output is activated. The ADT6501/ADT6503 logic output is active low and open-drain. The ADT6502/ADT6504 logic output is active high and push-pull. The temperature is digitized to a resolution of +0.0625°C (12 bit). The factory settings are 10°C apart starting from -45°C to +15°C for the cold threshold models and from +35°C to +115°C for the hot threshold models.

These devices require no external components and typically consume 30µA supply current. Hysteresis is pin selectable at 2°C and 10°C. The temperature switch is specified to operate over the supply range of 2.7 V to 5.5 V.

ADT6501 and ADT6502 are used for monitoring temperatures from +35°C to +115°C only. Hence, the logic output pin

#### Rev. PrA

Information furnished by Analog Devices is believed to be accurate and reliable. However, no responsibility is assumed by Analog Devices for its use, nor for any infringements of patents or other rights of third parties that may result from its use. Specifications subject to change without notice. No license is granted by implication or otherwise under any patent or patent rights of Analog Devices. Trademarks and registered trademarks are the property of their respective owners.

### FUNCTIONAL BLOCK DIAGRAM

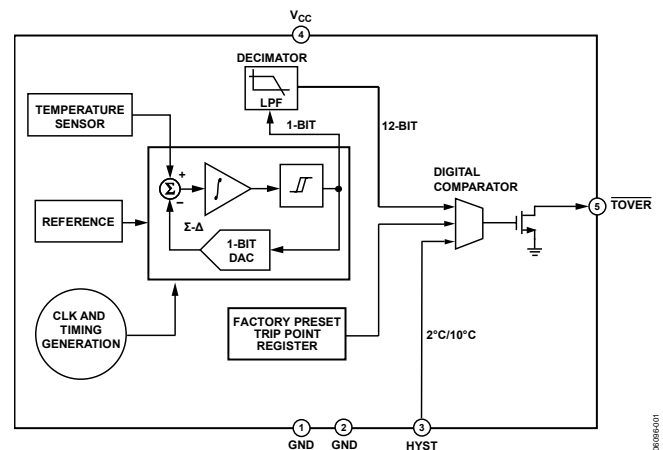

Figure 1.

becomes active when the temperature goes higher than the selected trip point temperature. The ADT6503 and ADT6504 are used for monitoring temperatures from -45°C to +15°C only. Hence, the logic output pin becomes active when the temperature goes lower than the selected trip point temperature.

### PRODUCT HIGHLIGHTS

1. ±0.5°C typical from -55°C to +125°C.
2. Factory threshold settings from -45°C to +115°C in 10°C increments
3. Supply voltage is 2.7 V to 5.5 V.
4. Supply current of 30 µA.
5. Space-saving 5-lead SOT23 package.
6. Pin selectable temperature hysteresis of 2°C or 10°C.
7. Temperature resolution of 0.0625°C.

**TABLE OF CONTENTS**

Features .....	1	Converter Details .....	8
Applications.....	1	Factory Programmed Threshold Range.....	8
Functional Block Diagram .....	1	Hysteresis Input .....	8
General Description .....	1	Functional Description.....	9
Product Highlights .....	1	Application Information.....	10
Specifications.....	3	Thermal Response Time .....	10
Absolute Maximum Ratings .....	4	Self-Heating Effects.....	10
ESD Caution.....	4	Supply Decoupling .....	10
Pin Configuration and Function Descriptions.....	5	Temperature Monitoring.....	11
Typical Performance Characteristics .....	6	Outline Dimensions .....	12
Theory of Operation .....	8	Ordering Guide .....	12
Circuit Information.....	8		

## SPECIFICATIONS

$T_A = T_{MIN}$  to  $T_{MAX}$ ,  $V_{DD} = 2.7$  V to 5.5 V. All specifications for  $-45^{\circ}\text{C}$  to  $+115^{\circ}\text{C}$ , unless otherwise noted. Open-drain  $R_{PULL-UP} = 100$  k $\Omega$ .

Table 1.

Parameter	Min	Typ	Max	Unit	Test Conditions/Comments
TEMPERATURE SENSOR AND ADC					
Threshold Accuracy at $V_{CC} = 2.7$ V to 5.5 V		$\pm 0.5$	$\pm 6$	$^{\circ}\text{C}$	$T_A = -45^{\circ}\text{C}$ to $-25^{\circ}\text{C}$
		$\pm 0.5$	$\pm 4$	$^{\circ}\text{C}$	$T_A = -15^{\circ}\text{C}$ to $+15^{\circ}\text{C}$
		$\pm 0.5$	$\pm 4$	$^{\circ}\text{C}$	$T_A = +35^{\circ}\text{C}$ to $+65^{\circ}\text{C}$
		$\pm 0.5$	$\pm 6$	$^{\circ}\text{C}$	$T_A = +75^{\circ}\text{C}$ to $+115^{\circ}\text{C}$
ADC Resolution		12		Bits	
Temperature Conversion Time		30		ms	Time necessary to complete a conversion
Update Rate		600		ms	Conversion started every 600 ms
Long Term Drift		0.08		$^{\circ}\text{C}$	Drift over 10 years, if part is operated at $+55^{\circ}\text{C}$
Temperature Hysteresis		+0.03		$^{\circ}\text{C}$	Temperature cycle = $25^{\circ}\text{C}$ to $125^{\circ}\text{C}$ to $25^{\circ}\text{C}$
Temperature Threshold Hysteresis		2		$^{\circ}\text{C}$	
		10		$^{\circ}\text{C}$	
DIGITAL INPUT (HYST)					
Input Low Voltage, $V_{IL}$			$0.2 \times V_{CC}$	V	
Input High Voltage, $V_{IH}$	$0.8 \times V_{CC}$			V	
DIGITAL OUTPUT (OPEN-DRAIN)					
Output High Current, $I_{OH}$		10		nA	Leakage current, $V_{CC} = 2.7$ V and $V_{OH} = 5.5$ V
Output Low Voltage, $V_{OL}$			0.3	V	$I_{OL} = 1.2$ mA, $V_{CC} = 2.7$ V
Output Low Voltage, $V_{OL}$			0.4	V	$I_{OL} = 3.2$ mA, $V_{CC} = 4.5$ V
Output Capacitance, $C_{OUT}^1$			10	pF	
DIGITAL OUTPUT (Push-Pull)					
Output Low Voltage, $V_{OL}$			0.3	V	$I_{OL} = 1.2$ mA, $V_{CC} = 2.7$ V
Output Low Voltage, $V_{OL}$			0.4	V	$I_{OL} = 3.2$ mA, $V_{CC} = 4.5$ V
Output High Voltage, $V_{OH}$	$0.8 \times V_{CC}$			V	$I_{SOURCE} = 500$ $\mu\text{A}$ , $V_{CC} = 2.7$ V
Output High Voltage, $V_{OH}$	$V_{CC} - 1.5$			V	$I_{SOURCE} = 800$ $\mu\text{A}$ , $V_{CC} = 4.5$ V
Output Capacitance, $C_{OUT}^1$			10	pF	
POWER REQUIREMENTS					
Supply Voltage	2.7		5.5	V	
Supply Current		30	85	$\mu\text{A}$	

<sup>1</sup> Guaranteed by design and characterization.

**ABSOLUTE MAXIMUM RATINGS**

Table 2.

Parameter	Rating
V <sub>CC</sub> to GND	-0.3 V to +7 V
HYST Input Voltage to GND	-0.3 V to V <sub>CC</sub> + 0.3 V
Open Drain Output Voltage to GND	-0.3 V to +7 V
Push-Pull Output Voltage to GND	-0.3 V to V <sub>DD</sub> + 0.3 V
Input Current on All Pins	20 mA
Output Current on All Pins	20 mA
Operating Temperature Range	-55°C to +125°C
Storage Temperature Range	-65°C to +160°C
Maximum Junction Temperature, T <sub>JMAX</sub>	150.7°C
5-Lead SOT-23 (RJ-5)	
Power Dissipation <sup>2</sup>	$W_{MAX} = (T_{JMAX} - T_A^3)/\theta_{JA}$
Thermal Impedance <sup>4</sup>	
θ <sub>JA</sub> , Junction-to-Ambient (still air)	240°C/W
IR Reflow Soldering (Pb-Free Package)	
Peak Temperature	260°C (+0°C)
Time at Peak Temperature	20 sec to 40 sec
Ramp-Up Rate	3°C/sec maximum
Ramp-Down Rate	-6°C/sec maximum
Time 25°C to Peak Temperature	8 minutes maximum

<sup>1</sup> Values relate to package being used on a standard 2-layer PCB. This gives a worst case θ<sub>JA</sub>. Refer to Figure 2 for a plot of maximum power dissipation vs. ambient temperature (T<sub>A</sub>).

<sup>2</sup> T<sub>A</sub> = ambient temperature.

<sup>3</sup> Junction-to-case resistance is applicable to components featuring a preferential flow direction, for example, components mounted on a heat sink. Junction-to-ambient resistance is more useful for air-cooled, PCB-mounted components

Stresses above those listed under Absolute Maximum Ratings may cause permanent damage to the device. This is a stress rating only; functional operation of the device at these or any other conditions above those indicated in the operational section of this specification is not implied. Exposure to absolute maximum rating conditions for extended periods may affect device reliability.

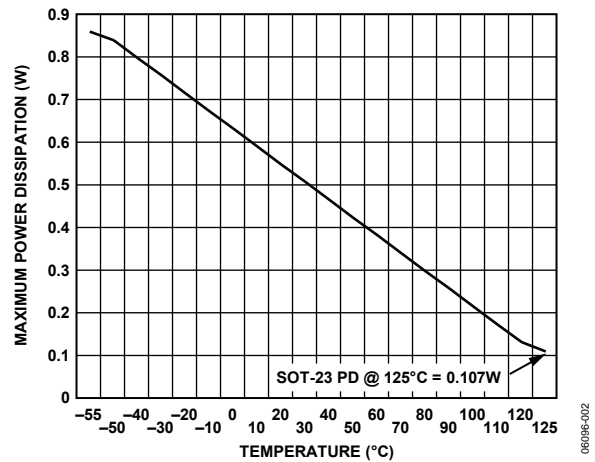

Figure 2. SOT-23 Maximum Power Dissipation vs. Temperature

**ESD CAUTION**

ESD (electrostatic discharge) sensitive device. Electrostatic charges as high as 4000 V readily accumulate on the human body and test equipment and can discharge without detection. Although this product features proprietary ESD protection circuitry, permanent damage may occur on devices subjected to high energy electrostatic discharges. Therefore, proper ESD precautions are recommended to avoid performance degradation or loss of functionality.



### PIN CONFIGURATION AND FUNCTION DESCRIPTIONS

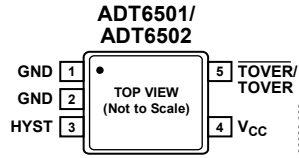

Figure 3. ADT6501/ADT6502 Pin Configuration

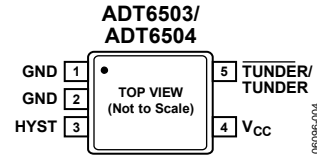
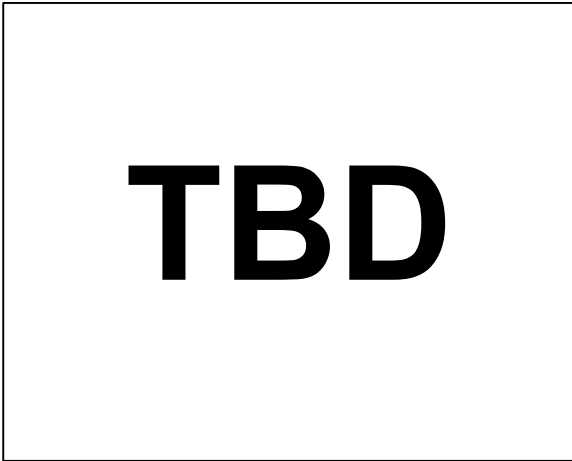

Figure 4. ADT6503/ADT6504 Pin Configuration

Table 3. Pin Function Descriptions

ADT6501/ADT6502 Pin No.	ADT6503/ADT6504 Pin No.	Mnemonic	Description
1	1	GND	Ground.
2	2	GND	Ground.
3	3	HYST	Hysteresis Input. Connects HYST to GND for +2°C hysteresis or connects to V <sub>CC</sub> for +10°C hysteresis.
4	4	V <sub>CC</sub>	Supply Input (+2.7 V to +5.5 V).
5	–	$\overline{\text{TOVER}}$	Open-Drain, Active-Low Output. $\overline{\text{TOVER}}$ goes low when the temperature of the part exceeds the factory programmed threshold; must use a pull-up resistor.
5	–	TOVER	Push-Pull, Active-High Output. TOVER goes high when the temperature of the part exceeds the factory programmed threshold.
–	5	$\overline{\text{TUNDER}}$	Open-Drain, Active-Low Output. $\overline{\text{TUNDER}}$ goes low when the temperature of the part exceeds the factory programmed threshold; must use a pull-up resistor.
–	5	TUNDER	Push-Pull, Active-High Output. TUNDER goes high when the temperature of the part exceeds the factory programmed threshold.

**TYPICAL PERFORMANCE CHARACTERISTICS**



*Figure 5.*

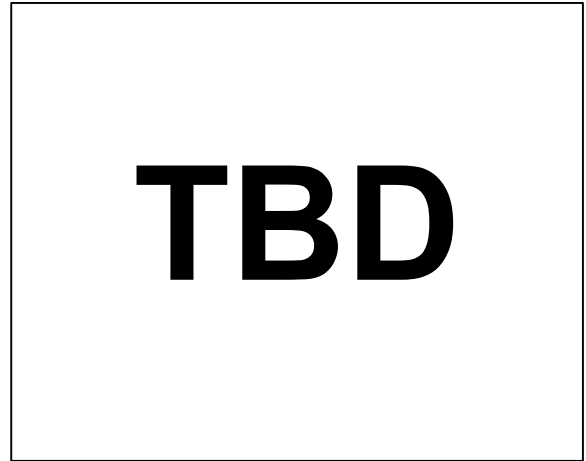

*Figure 8.*

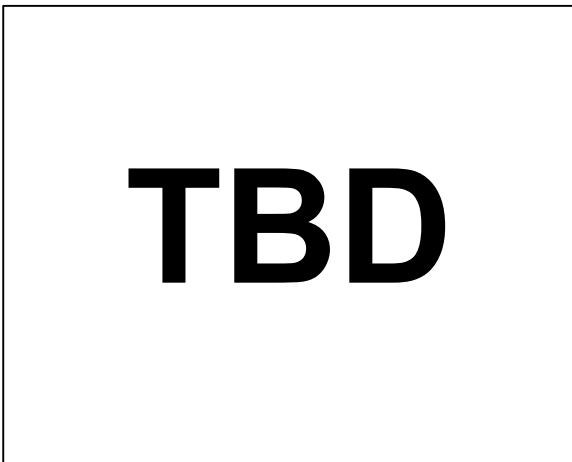

*Figure 6.*

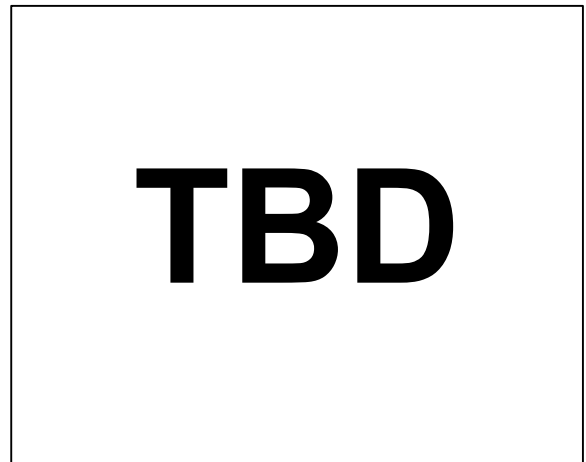

*Figure 9.*

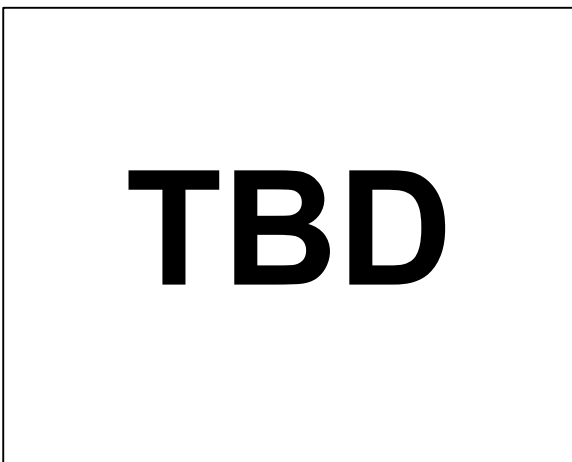

*Figure 7.*

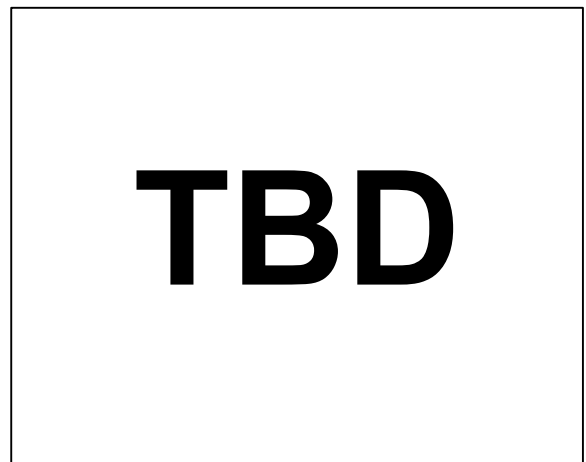

*Figure 10.*

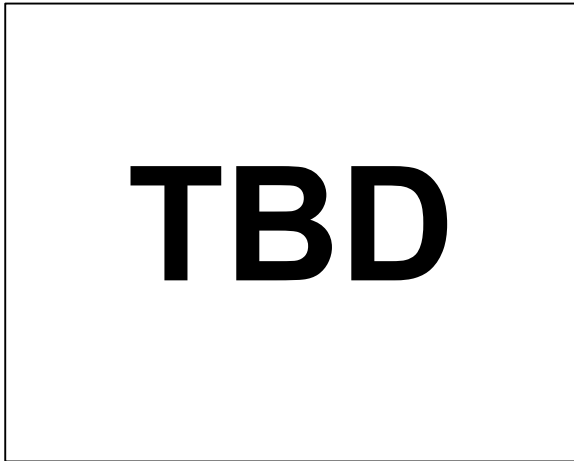

*Figure 11.*

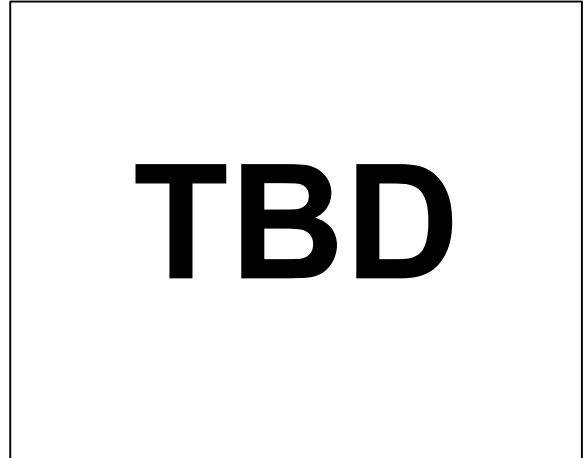

*Figure 13.*

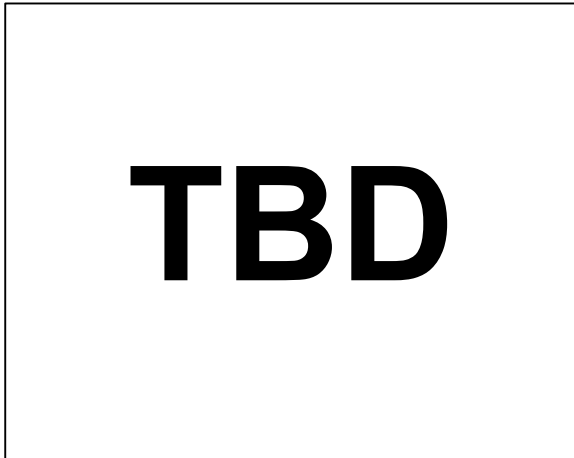

*Figure 12.*

## THEORY OF OPERATION

### CIRCUIT INFORMATION

The ADT6501/ADT6502/ADT6503/ADT6504 are 12-bit digital temperature sensors with the 12<sup>th</sup> bit acting as the sign bit. An on-board temperature sensor generates a voltage precisely proportional to absolute temperature that is compared to an internal voltage reference and input to a precision digital modulator. The 12-bit output from the modulator is input into a digital comparator where it is compared with a factory set trip level. The output trip pin is activated if the temperature measured is greater than the factory set trip level. Overall accuracy for the ADT650x family is  $\pm 6^{\circ}\text{C}$  from  $-45^{\circ}\text{C}$  to  $+115^{\circ}\text{C}$ .

The on-board temperature sensor has excellent accuracy and linearity over the entire rated temperature range without needing correction or calibration by the user. The ADT6501/ADT6503 have active-low, open-drain output structures that can only sink current. The ADT6502/ADT6504 have active-high, push-pull output structures that can sink and source current. On power-up, the output cannot become active until the first conversion is completed. This typically takes 30 ms.

The sensor output is digitized by a first-order,  $\Sigma$ - $\Delta$  modulator, also known as the charge balance type analog-to-digital converter (ADC). This type of converter utilizes time-domain oversampling and a high accuracy comparator to deliver 12 bits of effective accuracy in an extremely compact circuit.

### CONVERTER DETAILS

The  $\Sigma$ - $\Delta$  modulator consists of an input sampler, a summing network, an integrator, a comparator, and a 1-bit digital-to-analog converter (DAC). Similar to the voltage-to-frequency converter, this architecture creates a negative feedback loop and minimizes the integrator output by changing the duty cycle of the comparator output in response to input voltage changes. The comparator samples the output of the integrator at a much higher rate than the input sampling frequency; this is called oversampling. Oversampling spreads the quantization noise over a much wider band than that of the input signal, improving overall noise performance and increasing accuracy.

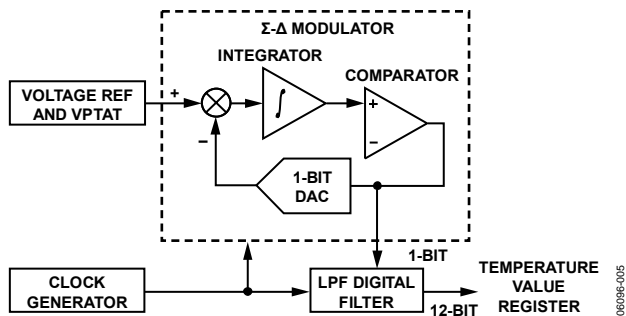

Figure 14. First-Order  $\Sigma$ - $\Delta$  Modulator

The modulated output of the comparator is encoded using a circuit technique that results in SMBus/I<sup>2</sup>C temperature data.

### FACTORY PROGRAMMED THRESHOLD RANGE

The ADT6501/ADT6502/ADT6503/ADT6504 are available with factory set threshold levels ranging from  $-45^{\circ}\text{C}$  to  $+115^{\circ}\text{C}$  in  $10^{\circ}\text{C}$ . The ADT6501/ADT6503 outputs are intended to interface to reset inputs of microprocessors. The ADT6502/ADT6504 are intended for driving circuits of applications, such as fan control circuits. Table 4 lists the available temperature threshold ranges.

Table 4. Factory Set Temperature Threshold Ranges

Device	Threshold ( $T_{\text{TH}}$ ) Range
ADT6501	$+35^{\circ}\text{C} < T_{\text{TH}} < +115^{\circ}\text{C}$
ADT6502	$+35^{\circ}\text{C} < T_{\text{TH}} < +115^{\circ}\text{C}$
ADT6503	$-45^{\circ}\text{C} < T_{\text{TH}} < +15^{\circ}\text{C}$
ADT6504	$-45^{\circ}\text{C} < T_{\text{TH}} < +15^{\circ}\text{C}$

### HYSTERESIS INPUT

The HYST pin is used to select a temperature hysteresis of  $2^{\circ}\text{C}$  or  $10^{\circ}\text{C}$ . If the HYST pin is connected to  $V_{\text{CC}}$  then a hysteresis of  $10^{\circ}\text{C}$  is selected or if the HYST pin is connected to GND then a hysteresis of  $2^{\circ}\text{C}$  is selected. The HYST pin should not be left floating. Hysteresis prevents oscillation on the output pin when the temperature is approaching the trip point, after it activates. For example, if the temperature trip is  $45^{\circ}\text{C}$  and the hysteresis selected is  $10^{\circ}\text{C}$ , the temperature would have to go as low as  $35^{\circ}\text{C}$  before the output deactivates.



**FUNCTIONAL DESCRIPTION**

The conversion clock for the part is generated internally. No external clock is required. The internal clock oscillator runs an automatic conversion sequence. During this automatic conversion sequence, a conversion is initiated every 600 ms. At this time, the part powers up its analog circuitry and performs a temperature conversion.

This temperature conversion typically takes 30 ms, after which time the analog circuitry of the part automatically shuts down. The analog circuitry powers up again 570 ms later, when the 600 ms timer times out and the next conversion begins. The result of the most recent temperature conversion is compared with the factory set trip point value. If the temperature measured is greater than the trip point value, the output is activated. The output is deactivated once the temperature crosses back over the trip point threshold plus whatever temperature hysteresis is selected. Figure 15 to Figure 18 show the transfer function for the output trip pin of each generic model.

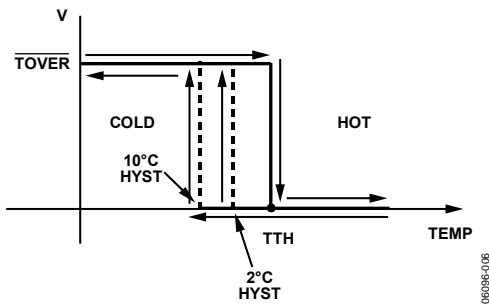

Figure 15. ADT6501  $\overline{TOVER}$  Transfer Function

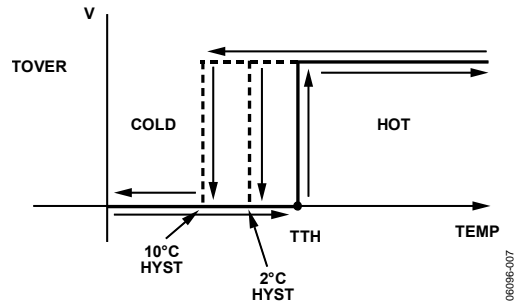

Figure 16. ADT6502  $\overline{TOVER}$  Transfer Function

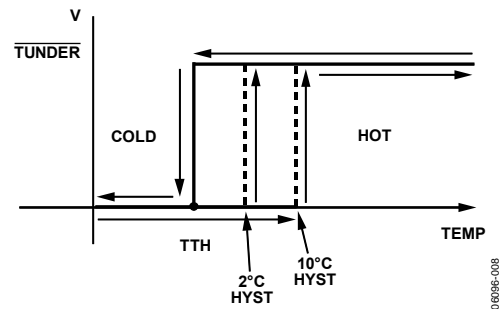

Figure 17. ADT6503  $\overline{TUNDER}$  Transfer Function

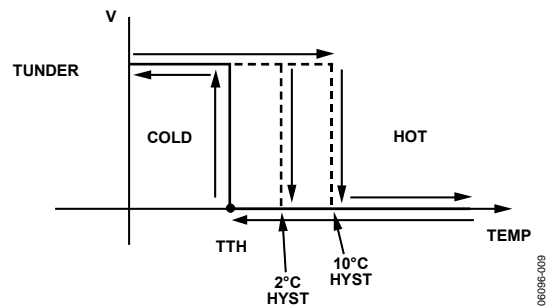

Figure 18. ADT6504  $\overline{TUNDER}$  Transfer Function

## APPLICATION INFORMATION

### THERMAL RESPONSE TIME

The time required for a temperature sensor to settle to a specified accuracy is a function of the thermal mass of the sensor and the thermal conductivity between the sensor and the object being sensed. Thermal mass is often considered equivalent to capacitance. Thermal conductivity is commonly specified using the symbol  $Q$ , and can be thought of as thermal resistance. It is commonly specified in units of degrees per watt of power transferred across the thermal joint. Thus, the time required for the ADT6501/ADT6502/ADT6503/ADT6504 to settle to the desired accuracy is dependent on the characteristics of the SOT-23 package, the thermal contact established in that particular application, and the equivalent power of the heat source. In most applications, the settling time is probably best determined empirically.

### SELF-HEATING EFFECTS

The temperature measurement accuracy of the ADT6501/ADT6502/ADT6503/ADT6504 can be degraded in some applications due to self-heating. Errors can be introduced from the quiescent dissipation and power dissipated when converting. The magnitude of these temperature errors is dependent on the thermal conductivity of the ADT650x package, the mounting technique, and the effects of airflow. At 25°C, static dissipation in the ADT650x is typically TBD  $\mu$ W operating at 3.3 V. In the 5-lead SOT-23 package mounted in free air, this accounts for a temperature increase due to self-heating of

$$\Delta T = P_{DISS} \times \theta_{JA} = \text{TBD } \mu\text{W} \times 240^\circ\text{C/W} = \text{TBD}^\circ\text{C}$$

It is recommended that current dissipated through the device be kept to a minimum, because it has a proportional effect on the temperature error.

### SUPPLY DECOUPLING

The ADT6501/ADT6502/ADT6503/ADT6504 should be decoupled with a 0.1  $\mu$ F ceramic capacitor between  $V_{DD}$  and GND. This is particularly important when the ADT650x are mounted remotely from the power supply. Precision analog products, such as the ADT650x, require a well-filtered power source. Because the ADT650x operate from a single supply, it might seem convenient to tap into the digital logic power supply.

Unfortunately, the logic supply is often a switch-mode design, which generates noise in the 20 kHz to 1 MHz range. In addition, fast logic gates can generate glitches hundreds of mV in amplitude due to wiring resistance and inductance.

If possible, the ADT650x should be powered directly from the system power supply. This arrangement, shown in Figure 19, isolates the analog section from the logic switching transients. Even if a separate power supply trace is not available, generous supply bypassing reduces supply line induced errors. Local supply bypassing consisting of a 0.1  $\mu$ F ceramic capacitor is advisable for the temperature accuracy specifications to be achieved. This decoupling capacitor must be placed as close as possible to the ADT650x  $V_{CC}$  pin.

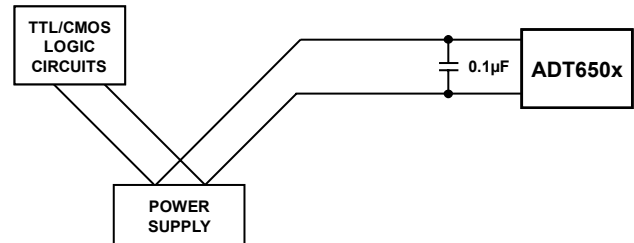

Figure 19. Use Separate Traces to Reduce Power Supply Noise

06098-010

**TEMPERATURE MONITORING**

The ADT6501/ADT6502/ADT6503/ADT6504 are ideal for monitoring the thermal environment within electronic equipment. For example, the surface-mount package accurately reflects the exact thermal conditions that affect nearby integrated circuits.

The ADT650x measure and convert the temperature at the surface of its own semiconductor chip. When the ADT650x are used to measure the temperature of a nearby heat source, the thermal impedance between the heat source and the ADT650x must be as low as possible.

As much as 60% of the heat transferred from the heat source to the thermal sensor on the ADT650x die is discharged via the copper tracks, package pins, and bond pads. Of the pins on the ADT650x, the GND pins transfer most of the heat. Therefore, to monitor the temperature of a heat source it is recommended that the thermal resistance between the ADT650x GND pins and the GND of the heat source is reduced as much as possible.

For example, use the unique properties of the ADT650x to monitor a high power dissipation microprocessor. The ADT650x device, in its SOT-23 package, is mounted directly beneath the microprocessor's pin grid array (PGA) package. The ADT650x requires no external characterization.

OUTLINE DIMENSIONS

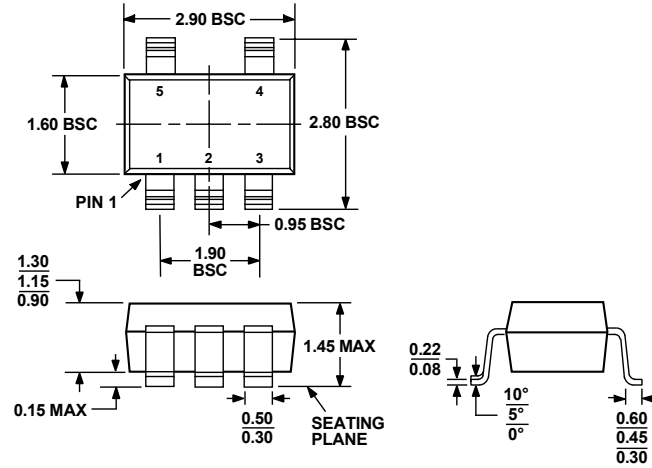

COMPLIANT TO JEDEC STANDARDS MO-178-AA

Figure 20. 5-Lead Small Outline Transistor Package [SOT-23] (RJ-5)

Dimensions shown in millimeters

ORDERING GUIDE

Model	Threshold Temperature	Temperature Accuracy	Package Description	Package Option
ADT6501ARJP035	+35°C	±4°C	5-Lead SOT-23	RJ-5
ADT6501ARJP045	+45°C	±4°C	5-Lead SOT-23	RJ-5
ADT6501ARJP055	+55°C	±4°C	5-Lead SOT-23	RJ-5
ADT6501ARJP065	+65°C	±4°C	5-Lead SOT-23	RJ-5
ADT6501ARJP075	+75°C	±6°C	5-Lead SOT-23	RJ-5
ADT6501ARJP085	+85°C	±6°C	5-Lead SOT-23	RJ-5
ADT6501ARJP095	+95°C	±6°C	5-Lead SOT-23	RJ-5
ADT6501ARJP105	+105°C	±6°C	5-Lead SOT-23	RJ-5
ADT6501ARJP115	+115°C	±6°C	5-Lead SOT-23	RJ-5
ADT6502ARJP035	+35°C	±4°C	5-Lead SOT-23	RJ-5
ADT6502ARJP045	+45°C	±4°C	5-Lead SOT-23	RJ-5
ADT6502ARJP055	+55°C	±4°C	5-Lead SOT-23	RJ-5
ADT6502ARJP065	+65°C	±4°C	5-Lead SOT-23	RJ-5
ADT6502ARJP075	+75°C	±6°C	5-Lead SOT-23	RJ-5
ADT6502ARJP085	+85°C	±6°C	5-Lead SOT-23	RJ-5
ADT6502ARJP095	+95°C	±6°C	5-Lead SOT-23	RJ-5
ADT6502ARJP105	+105°C	±6°C	5-Lead SOT-23	RJ-5
ADT6502ARJP115	+115°C	±6°C	5-Lead SOT-23	RJ-5
ADT6503ARJN045	-45°C	±6°C	5-Lead SOT-23	RJ-5
ADT6503ARJN035	-35°C	±6°C	5-Lead SOT-23	RJ-5
ADT6503ARJN025	-25°C	±6°C	5-Lead SOT-23	RJ-5
ADT6503ARJN015	-15°C	±4°C	5-Lead SOT-23	RJ-5
ADT6503ARJN005	-5°C	±4°C	5-Lead SOT-23	RJ-5
ADT6503ARJP005	+5°C	±4°C	5-Lead SOT-23	RJ-5
ADT6503ARJP015	+15°C	±4°C	5-Lead SOT-23	RJ-5
ADT6504ARJN045	-45°C	±6°C	5-Lead SOT-23	RJ-5
ADT6504ARJN035	-35°C	±6°C	5-Lead SOT-23	RJ-5
ADT6504ARJN025	-25°C	±6°C	5-Lead SOT-23	RJ-5
ADT6504ARJN015	-15°C	±4°C	5-Lead SOT-23	RJ-5
ADT6504ARJN005	-5°C	±4°C	5-Lead SOT-23	RJ-5
ADT6504ARJP005	+5°C	±4°C	5-Lead SOT-23	RJ-5
ADT6504ARJP015	+15°C	±4°C	5-Lead SOT-23	RJ-5

## NOTES

**NOTES**

## NOTES

**NOTES**

Purchase of licensed I<sup>2</sup>C components of Analog Devices or one of its sublicensed Associated Companies conveys a license for the purchaser under the Philips I<sup>2</sup>C Patent Rights to use these components in an I<sup>2</sup>C system, provided that the system conforms to the I<sup>2</sup>C Standard Specification as defined by Philips.

©2006 Analog Devices, Inc. All rights reserved. Trademarks and registered trademarks are the property of their respective owners.  
PR06096-0-10/06(PrA)



**www.analog.com**