

LM7705

Low Noise Negative Bias Generator

General Description

The LM7705 is a switched capacitor voltage inverter with a low noise, $-0.23V$ fixed negative voltage regulator. This device is designed to be used with low voltage amplifiers to enable the amplifiers output to swing to zero volts. The -0.23 volts is used to supply the negative supply pin of an amplifier while maintaining less than 5.5 volts across the amplifier. Rail-to-Rail output amplifiers cannot output zero volts when operating from a single supply voltage and can result in error accumulation due to amplifier output saturation voltage being amplified by following gain stages. A small negative supply voltage will prevent the amplifiers output from saturating at zero volts and will help maintain an accurate zero through a signal processing chain. Additionally, when an amplifier is used to drive an ADC's input, it can output a zero voltage signal and the full input range of an ADC can be used. The LM7705 has a shutdown pin to minimize standby power consumption

Features

- Regulated output voltage $-0.232V$
- Output voltage tolerance 5%
- Output voltage ripple 4 mV_{PP}
- Max output current 26 mA
- Supply voltage 3V to 5.25V
- Conversion efficiency up to 98%
- Quiescent current $78\text{ }\mu A$
- Shutdown current 20 nA
- Turn on time $500\text{ }\mu s$
- Operating temperature range $-40^{\circ}C$ to $125^{\circ}C$
- 8-Pin MSOP Package

Applications

- True zero amplifier output
- Portable instrumentation
- Low voltage split power supplies

Typical Application

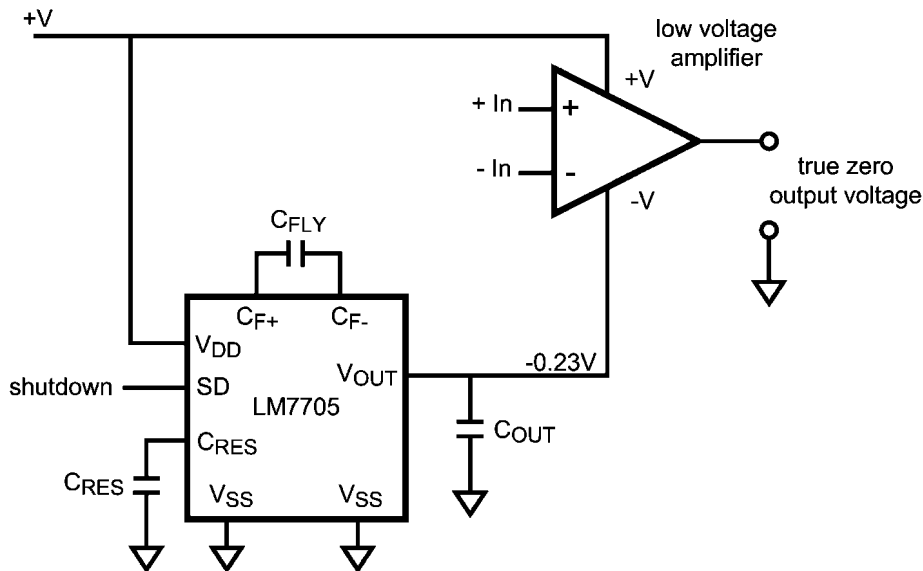

20173001

Absolute Maximum Ratings (Note 1)

If Military/Aerospace specified devices are required, please contact the National Semiconductor Sales Office/ Distributors for availability and specifications.

Supply Voltage		+5.75V
$V_{DD} - V_{SS}$		
SD	$V_{DD}+0.3V, V_{SS}-0.3V$	
ESD Tolerance (Note 2)		
Human Body Model		
For input pins only		2000V
For all other pins		2000V
Machine Model		200V

Charge Device Model	750V
Storage Temp. Range	-65°C to 150°C
Junction Temperature (Note 7)	150°C max
Mounting Temperature	
Infrared or Convection (20 sec)	260°C

Operating Ratings

Supply Voltage (V_{DD} to GND)	3V to 5.25V
Supply Voltage (V_{DD} wrt V_{OUT})	3.23V to 5.48V
Temperature Range	-40°C to 125°C
Thermal Resistance (θ_{JA})	
8-Pin MSOP	253°C/W

3.3V Electrical Characteristics

Unless otherwise specified, all limits are guaranteed for $T_A = 25^\circ\text{C}$, $V_{DD} = 3.3\text{V}$, $V_{SS} = 0\text{V}$, $SD = 0\text{V}$, $C_{FLY} = 5\ \mu\text{F}$, $C_{RES} = 22\ \mu\text{F}$, $C_{OUT} = 22\ \mu\text{F}$. **Boldface** limits apply at temperature extremes (Note 5).

Symbol	Parameter	Conditions	Min (Note 6)	Typical (Note 7)	Max (Note 6)	Units
V_{OUT}	Output Voltage	$I_{OUT} = 0\ \text{mA}$	-0.242 -0.251	-0.232	-0.219 -0.209	V
		$I_{OUT} = -20\ \text{mA}$	-0.242 -0.251	-0.226	-0.219 -0.209	
V_R	Output Voltage Ripple	$I_{OUT} = -20\ \text{mA}$		4		mV_{PP}
I_S	Supply Current	No Load	50	78	100 150	μA
I_{SD}	Shutdown Supply Current	$SD = V_{DD}$		20		nA
η_{POWER}	Current Conversion Efficiency	$-5\ \text{mA} \leq I_{OUT} \leq -20\ \text{mA}$		98		%
η_{POWER}	Current Conversion Efficiency	$I_{OUT} = -5\ \text{mA}$		98		%
t_{ON}	Turn On Time	$I_{OUT} = -5\ \text{mA}$		500		μs
t_{OFF}	Turn Off Time	$I_{OUT} = -5\ \text{mA}$		700		μs
$t_{OFF\ CP}$	Turn Off Time Charge Pump	$I_{OUT} = -5\ \text{mA}$		11		μs
Z_{OUT}	Output Impedance	$-1\ \text{mA} \leq I_{OUT} \leq -20\ \text{mA}$		0.23	0.8 1.3	Ω
I_{O_MAX}	Maximum Output Current	$V_{OUT} < -200\ \text{mV}$	-26			mA
f_{OSC}	Oscillator Frequency			92		kHz
V_{IL}	Shutdown Input Low				1.6 1.25	V
V_{IH}	Shutdown Input High		1.85 2.15			V
I_C	Shutdown Pin Input Current	$SD = V_{DD}$		50		pA
	Load Regulation	$0\ \text{mA} \leq I_{OUT} \leq -20\ \text{mA}$		0.12	0.6 0.85	%/mA
	Line Regulation	$3\text{V} \leq V_{DD} \leq 5.25\text{V}$ (No Load)	-0.2	0.29	0.7 1.1	%/V

5.0V Electrical Characteristics

Unless otherwise specified, all limits are guaranteed for $T_A = 25^\circ\text{C}$, $V_{DD} = 5.0\text{V}$, $V_{SS} = 0\text{V}$, $SD = 0\text{V}$, $C_{FLY} = 5\ \mu\text{F}$, $C_{RES} = 22\ \mu\text{F}$, $C_{OUT} = 22\ \mu\text{F}$. **Boldface** limits apply at temperature extremes (Note 5).

Symbol	Parameter	Conditions	Min (Note 6)	Typical (Note 7)	Max (Note 6)	Units
V_{OUT}	Output Voltage	$I_{OUT} = 0\ \text{mA}$	-0.242 -0.251	-0.233	-0.219 -0.209	V
		$I_{OUT} = -20\ \text{mA}$	-0.242 -0.251	-0.226	-0.219 -0.209	
V_R	Output Voltage Ripple	$I_{OUT} = -20\ \text{mA}$		4		mV _{PP}
I_S	Supply Current	No Load	60	103	135 240	μA
I_{SD}	Shutdown Supply Current	$SD = V_{DD}$		20		nA
η_{POWER}	Current Conversion Efficiency	$-5\ \text{mA} \leq I_{OUT} \leq -20\ \text{mA}$		98		%
η_{POWER}	Current Conversion Efficiency	$I_{OUT} = -5\ \text{mA}$		98		%
t_{ON}	Turn On Time	$I_{OUT} = -5\ \text{mA}$		200		μs
t_{OFF}	Turn Off Time	$I_{OUT} = -5\ \text{mA}$		700		μs
$t_{OFF\ CP}$	Turn Off Time Charge Pump	$I_{OUT} = -5\ \text{mA}$		11		μs
Z_{OUT}	Output Impedance	$-1\ \text{mA} \leq I_{OUT} \leq -20\ \text{mA}$		0.26	0.8 1.3	Ω
I_{O_MAX}	Maximum Output Current	$V_{OUT} < -200\ \text{mV}$	-35			mA
f_{OSC}	Oscillator Frequency			91		kHz
V_{IL}	Shutdown Input Low				2.55 1.95	V
V_{IH}	Shutdown Input High		2.8 3.25			V
I_C	Shutdown Pin Input Current	$SD = V_{DD}$		50		μA
	Load Regulation	$0\ \text{mA} \leq I_{OUT} \leq -20\ \text{mA}$		0.14	0.6 0.85	%/mA
	Line Regulation	$3\text{V} \leq V_{DD} \leq 5.25\text{V}$ (No Load)	-0.2	0.29	0.7 1.1	%/V

Note 1: Absolute Maximum Ratings indicate limits beyond which damage to the device may occur. Operating Ratings indicate conditions for which the device is intended to be functional, but specific performance is not guaranteed. For guaranteed specifications and test conditions, see the Electrical Characteristics.

Note 2: Human Body Model, applicable std. MIL-STD-883, Method 3015.7. Machine model, applicable std. JESD22-A115-A (ESD MM srd of JEDEC). Field induced Charge-Device Model, applicable std. JESD22-C101-C. (ESD FICDM std of JEDEC).

Note 3: The maximum power dissipation is a function of $T_{J(MAX)}$, θ_{JA} , and T_A . The maximum allowable power dissipation at any ambient temperature is $P_D = (T_{J(MAX)} - T_A) / \theta_{JA}$. All numbers apply for packages soldered directly onto a PC board.

Note 4: Electrical Table values apply only for factory testing conditions at the temperature indicated. Factory testing conditions result in very limited self-heating of the device such that $T_J = T_A$. No guarantee of parametric performance is indicated in the electrical tables under conditions of internal self-heating where $T_J > T_A$.

Note 5: Boldface limits apply to temperature range of -40°C to 125°C

Note 6: All limits are guaranteed by testing or statistical analysis.

Note 7: Typical values represent the most likely parametric norm as determined at the time of characterization. Actual typical values may vary over time and will also depend on the application and configuration. The typical values are not tested and are not guaranteed on shipped production material.

Connection Diagram

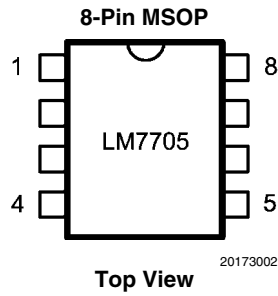

Pin Descriptions

Pin Number	Symbol	Description
1	C_{F+}	C_{FLY} Positive Capacitor Connection
2	V_{SS}	Power Ground
3	SD	Shutdown Pin If SD pin is LOW, device is ON If SD pin is HIGH, device is OFF
4	V_{DD}	Positive Supply Voltage
5	V_{SS}	Power Ground
6	V_{OUT}	Output Voltage
7	C_{RES}	Reserve Capacitor Connection
8	C_{F-}	C_{FLY} Negative Capacitor Connection

Ordering Information

Package	Part Number	Package Marking	Transport Media	NSC Drawing
8-Pin MSOP	LM7705MM	F26A	1k Units Tape and Reel	MUA08A
	LM7705MME		250 Units Tape and Reel	
	LM7705MMX		3.5k Units Tape and Reel	

Block Diagram

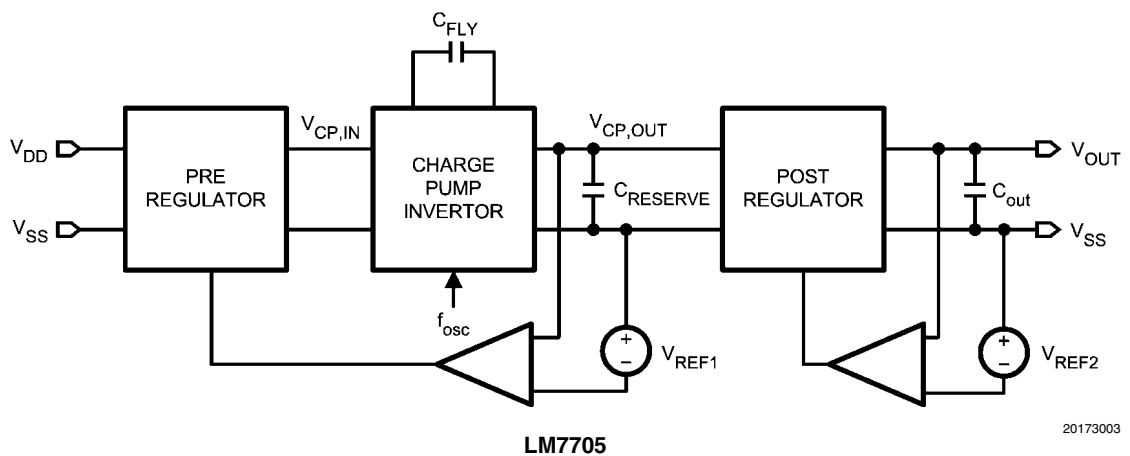

Typical Performance Characteristics $V_{DD} = 3.3V$ and $T_A = 25^\circ C$ unless otherwise noted.

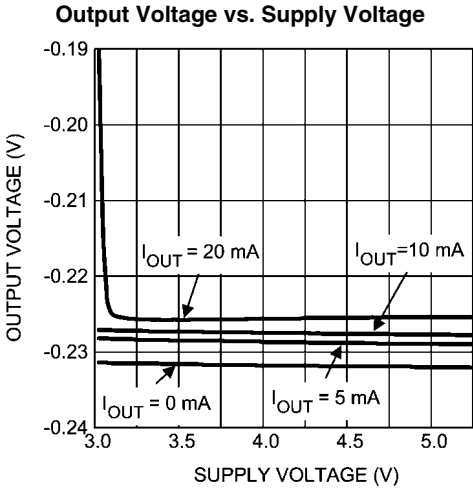

20173010

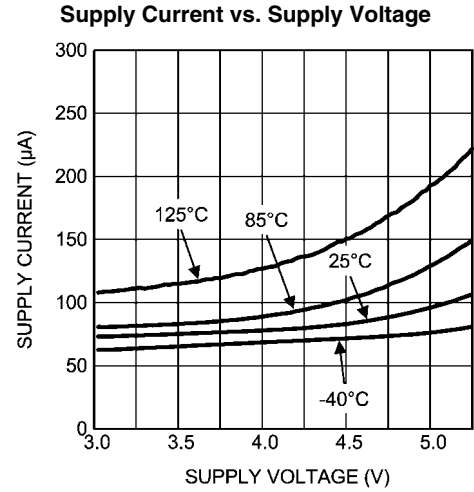

20173011

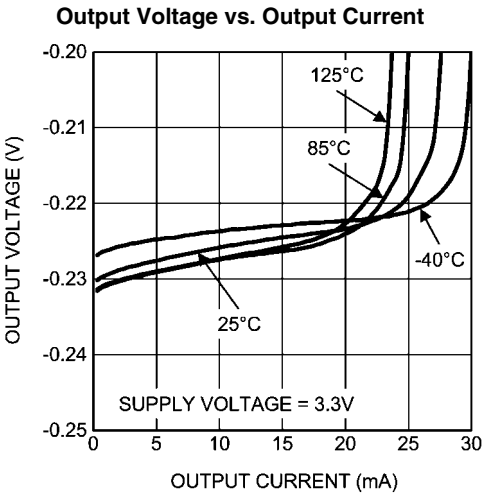

20173012

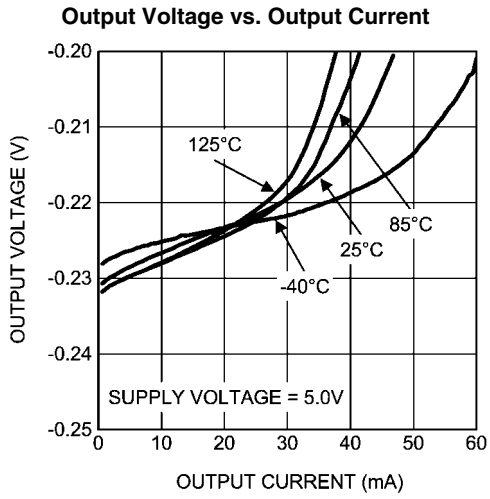

20173013

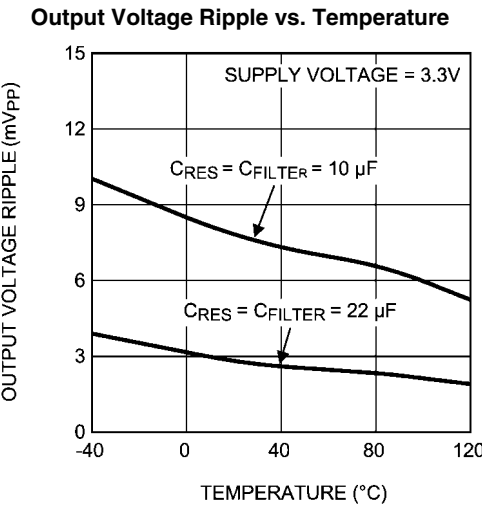

20173014

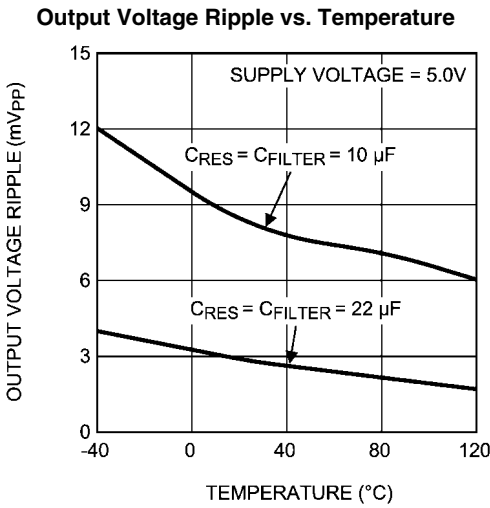

20173015

Supply Current vs. Output Current

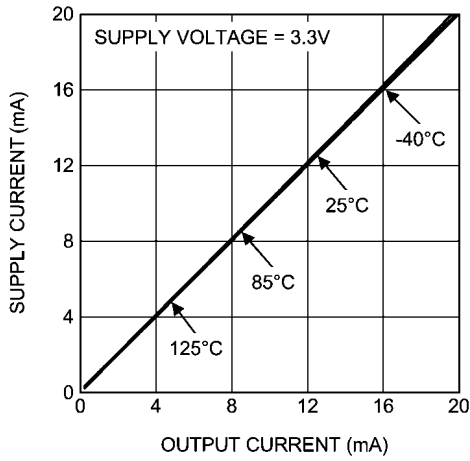

20173016

Supply Current vs. Output Current

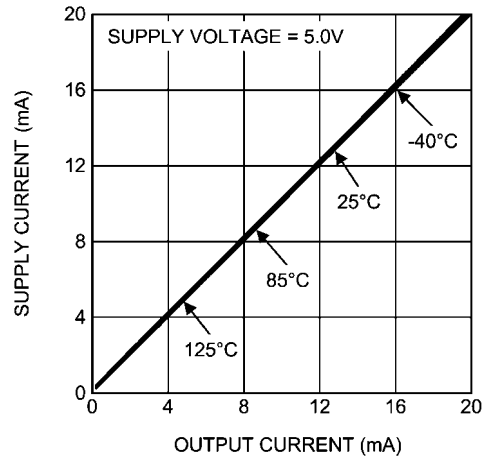

20173017

Current Conversion Efficiency vs. Output Current

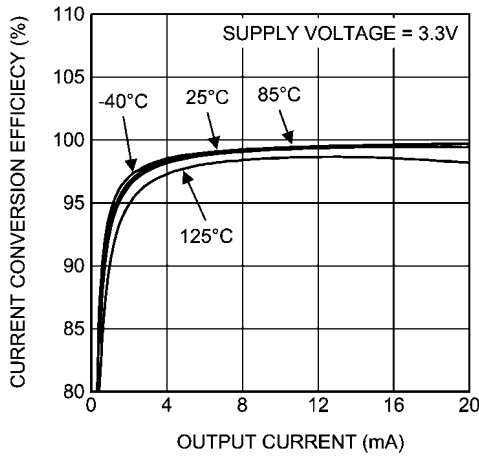

20173018

Current Conversion Efficiency vs. Output Current

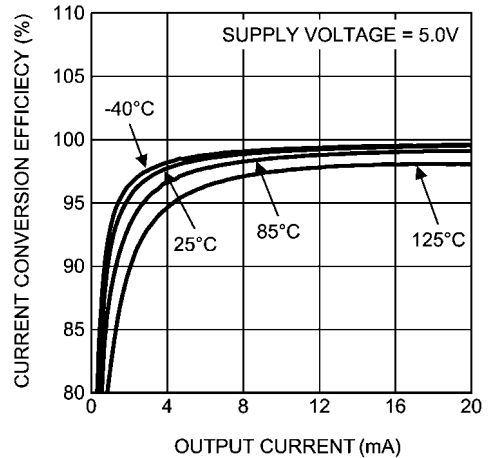

20173019

Turn On Time

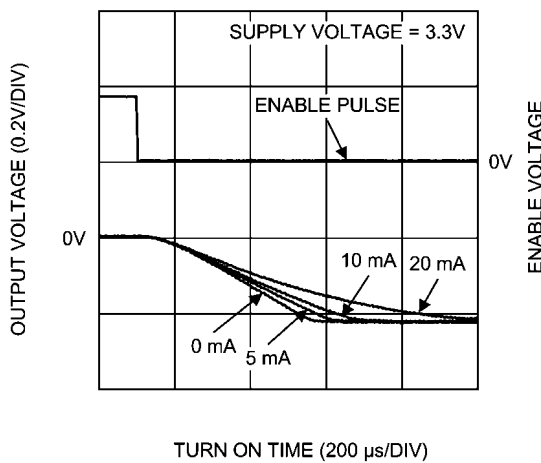

20173020

Turn On Time

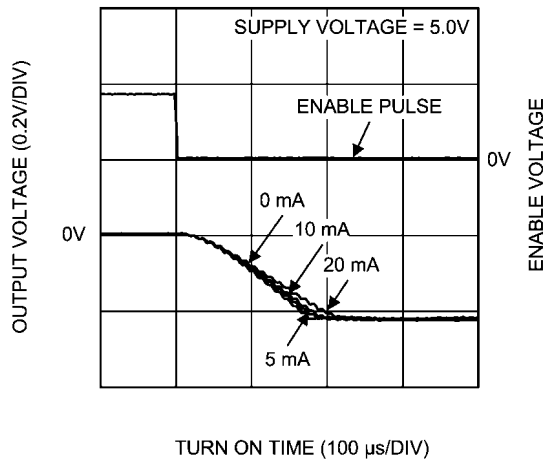

20173021

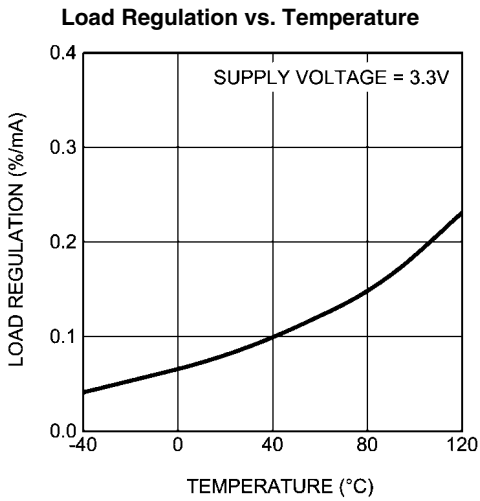

20173022

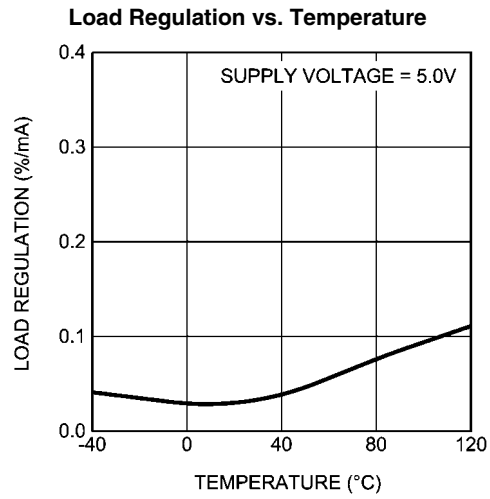

20173023

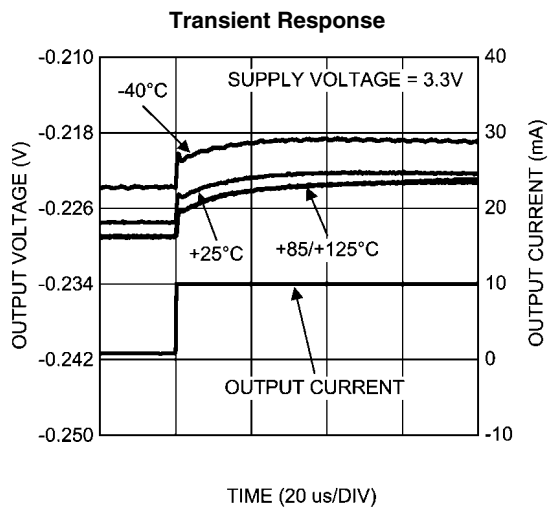

20173024

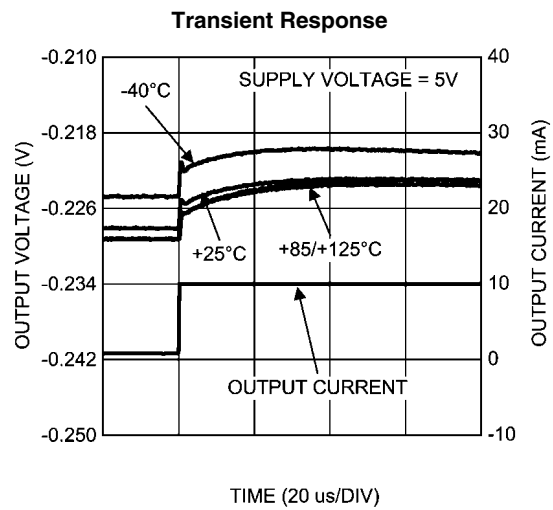

20173025

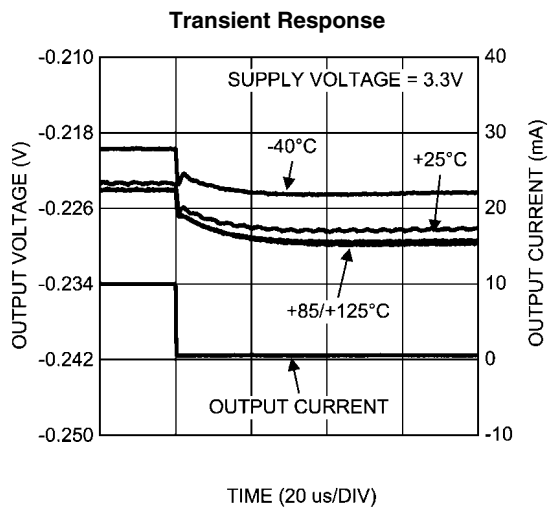

20173029

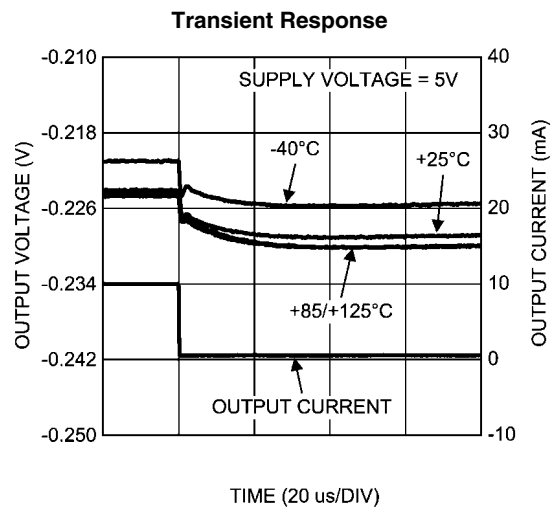

20173030

Output voltage vs. shutdown Voltage

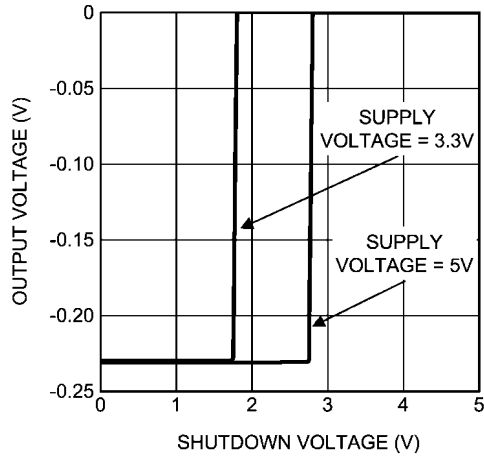

20173026

Supply Current vs. Shutdown Voltage

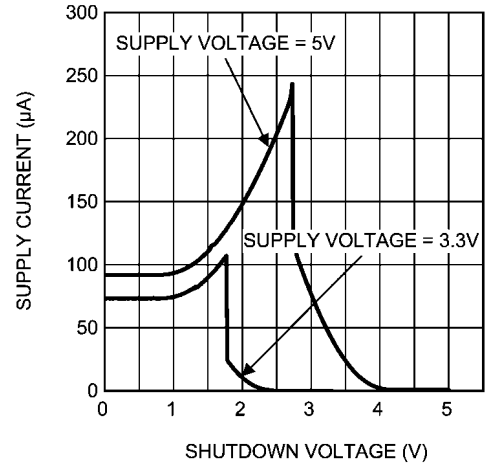

20173027

Oscillator Frequency vs. Temperature

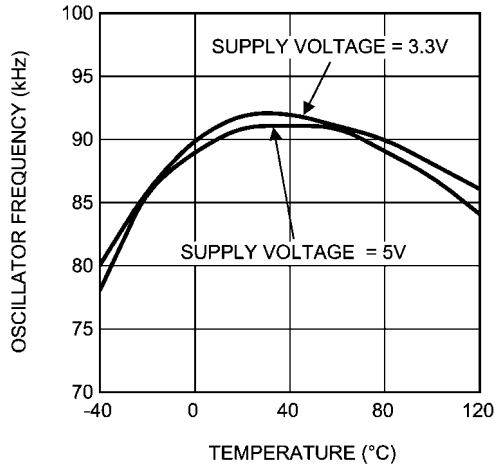

20173028

Application Information

This applications section will give a description of the functionality of the LM7705. The LM7705 is a switched capacitor voltage inverter with a low noise, $-0.23V$ fixed negative bias output. The part will operate over a supply voltage range of 3 to 5.25 Volt. Applying a logical low level to the SD input will activate the part, and generate a fixed $-0.23V$ output voltage. The part can be disabled; the output is switched to ground level, by applying a logical high level to the SD input of the part.

FUNCTIONAL DESCRIPTION

The LM7705, low noise negative bias generator, can be used for many applications requiring a fixed negative voltage. A key application for the LM7705 is an amplifier with a true zero output voltage using the original parts, while not exceeding the maximum supply voltage ratings of the amplifier.

The voltage inversion in the LM7705 is achieved using a switched capacitor technique with two external capacitors (C_{FLY} and C_{RES}). An internal oscillator and a switching network transfers charge between the two storage capacitors. This switched capacitor technique is given in *Figure 1*.

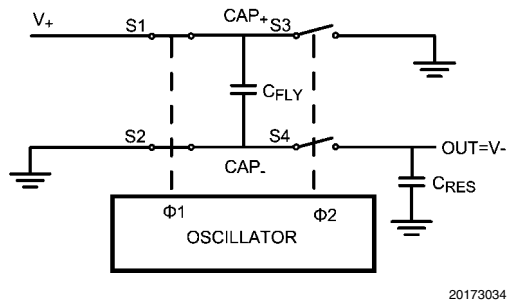

FIGURE 1. Voltage Inverter

The internal oscillator generates two anti-phase clock signals. Clock 1 controls switches S1 and S2. Clock 2 controls switches S3 and S4. When switches S1 and S2 are closed, capacitor C_{FLY} is charged to $V+$. When switches S3 and S4 are closed (S1 and S2 are open) charge from C_{FLY} is transferred to C_{RES} and the output voltage OUT is equal to $-V+$.

Due to the switched capacitor technique a small ripple will be present at the output voltage, with a frequency of the oscillator. The magnitude of this ripple will increase for increasing output currents. The magnitude of the ripple can be influenced by changing the values of the used capacitors.

In the next section a more detailed technical description of the LM7705 will be given.

TECHNICAL DESCRIPTION

As indicated in the functional description section, the main function of the LM7705 is to supply a stabilized negative bias voltage to a load, using only a positive supply voltage. A general block diagram for this charge pump inverter is given in *Figure 2*. The external power supply and load are added in this diagram as well.

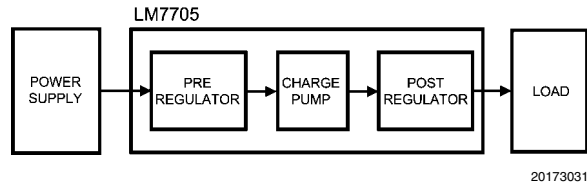

FIGURE 2. LM7705 Architecture

The architecture given in *Figure 2* shows that the LM7705 contains 3 functional blocks:

- Pre-regulator
- Charge pump inverter
- Post-regulator

The output voltage is stabilized by:

- Controlling the power supplied from the power supply to the charge pump input by the pre-regulator
- The power supplied from the charge pump output to the load by the post-regulator.

A more detailed block diagram of the negative bias generator is given in *Figure 3*. The control of the pre-regulator is based on measuring the output voltage of the charge pump. The goal of the post-regulator is to provide an accurate controlled negative voltage at the output, and acts as a low pass filter to attenuate the output voltage ripple. The voltage ripple is a result of the switching behavior of the charge pump and is dependent of the output current and the values of the used capacitors.

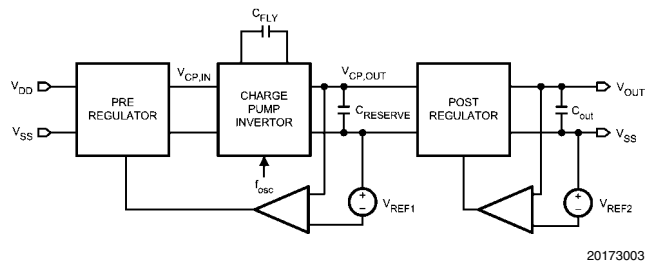

FIGURE 3. Charge Pump Inverter with Input/Output Control

In the next section a simple equation will be derived, that shows the relation between the ripple of the output current, the frequency of the internal clock generator and the value of the capacitor placed at the output of the LM7705.

Charge Pump Theory

This section uses a simplified but realistic equivalent circuit that represents the basic function of the charge pump. The schematic is given in *Figure 4*.

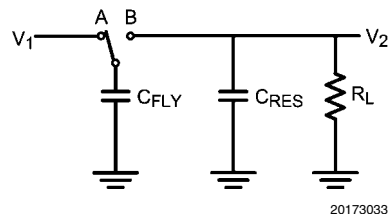

FIGURE 4. Charge Pump

When the switch is in position A, capacitor C_{FLY} will charge to voltage V_1 . The total charge on capacitor C_{FLY} is $Q_1 = C_{FLY} \times V_1$. The switch then moves to position B, discharging C_{FLY} to voltage V_2 . After this discharge, the charge on C_{FLY} will be $Q_2 = C_{FLY} \times V_2$. Note that the charge has been transferred from the source V_1 to the output V_2 . The amount of charge transferred is:

$$\Delta q = q_1 - q_2 = C_{FLY} (V_1 - V_2) \quad (1)$$

When the switch changes between A and B at a frequency f , the charge transfer per unit time, or current is:

$$I = f \Delta q = f C_{FLY} (V_1 - V_2) \quad (2)$$

The switched capacitor network can be replaced by an equivalent resistor, as indicated in *Figure 5*.

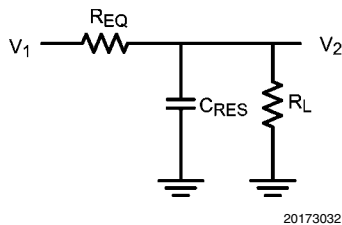

FIGURE 5. Switched Capacitor Equivalent Circuit

The value of this resistor is dependent on both the capacitor value and the switching frequency as given in *Equation 3*

$$I = \frac{V_1 - V_2}{\left(\frac{1}{f C_{FLY}}\right)} = \frac{V_1 - V_2}{R_{EQ}} \quad (3)$$

The value for R_{EQ} can be calculated from *Equation 3* and is given in *Equation 4*

$$R_{EQ} = \left(\frac{1}{f C_{FLY}}\right) \quad (4)$$

Equation 4 show that the value for the resistance at an increased internal switching frequency, allows a lower value for the used capacitor.

Key Specification

The key specifications for the LM7705 are given in the following overview:

Supply Voltage	The LM7705 will operate over a supply voltage range of 3V to 5.25V, and meet the specifications given in the Electrical Table. Supply voltage lower than 3.3 Volt will decrease performance (The output voltage will shift towards zero, and the current sink capabilities will decrease) A voltage higher than 5.25V will exceed the Abs Max ratings and therefore damage the part.
Output Voltage/ Line Regulation	The fixed and regulated output voltage of -0.23 V has tight limits, as indicated in the Electrical Characteristics table, to guarantee a stable voltage level. The usage of the pre- and post regulator in combination with the charge pump inverter ensures good line regulation of $0.29\%/V$
Output current/ Load regulation	The LM7705 can sink currents $> 26\text{ mA}$, causing an output voltage shift to -200 mV . A specified load-regulation of $0.14\% \text{ mA/V}$ ensures a minor voltage deviation for load current up to 20 mA .
Quiescent current	The LM7705 consumes a quiescent current less than $100\text{ }\mu\text{A}$. Sinking a load current, will result in a current conversion efficiency better than 90% , even for load currents of 1 mA , increasing to 98% for a current of 5 mA .

In the next section a general amplifier application requiring a true-zero output, will be discussed, showing an increased performance using the LM7705.

GENERAL AMPLIFIER APPLICATION

This section will discuss a general DC coupled amplifier application. First, one of the limitations of a DC coupled amplifier is discussed. This is illustrated with two application examples. A solution is given for solving this limitation by using the LM7705.

Due to the architecture of the output stage of general amplifiers, the output transistors will saturate. As a result, the output of a general purpose op amp can only swing to a few 100 mV of the supply rails. Amplifiers using CMOS technology do have a lower output saturation voltage. This is illustrated in *Figure 6*. E.g. National Semiconductors LM7332 can swing to 200 mV to the negative rail, for a $10\text{ k}\Omega$ load, over all temperatures.

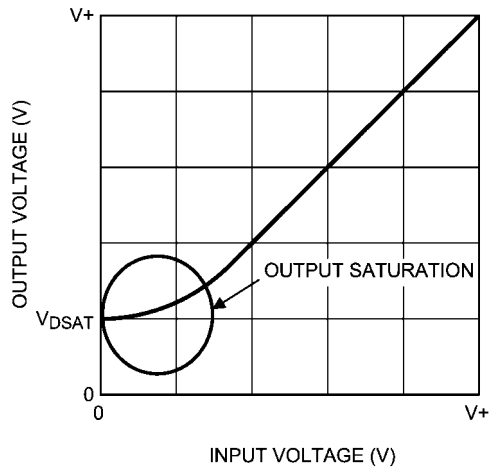

20173040

FIGURE 6. Limitation of the Output of an Amplifier

The introduction of operational amplifiers with output Rail-to-rail drive capabilities is a strong improvement and the (output) performance of op amps is for many applications no longer a limiting factor. For example, National Semiconductors LMP7701 (a typical rail-to-rail op amp), has an output drive capability of only 50 mV over all temperatures for a 10 k Ω load resistance. This is close to the lower supply voltage rail.

However, for true zero output applications with a single supply, the saturation voltage of the output stage is still a limiting factor. This limitation has a negative impact on the functionality of true zero output applications. This is illustrated in Figure 7.

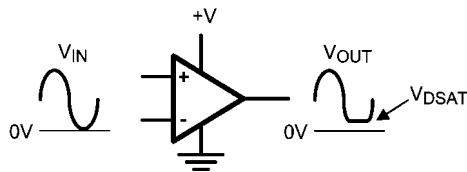

20173041

FIGURE 7. Output Limitation for Single Supply True Zero Output Application

In the following section, two applications will be discussed, showing the limitations of the output stage of an op amp in a single supply configuration.

- A single stage true zero amplifier, with a 12 bit ADC back end.
- A dual stage true zero amplifier, with a 12 bit ADC back end.

One-stage, Single Supply True Zero Amplifier

This application shows a sensor with a DC output signal, amplified by a single supply op amp. The output voltage of the op amp is converted to the digital domain using an Analog to Digital Converter (ADC). Figure 8 shows the basic setup of this application.

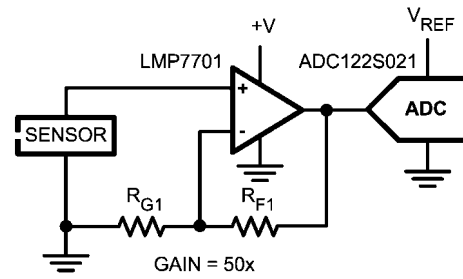

20173035

FIGURE 8. Sensor with DC Output and a Single Supply Op Amp

The sensor has a DC output signal that is amplified by the op amp. For an optimal signal-to-noise ratio, the output voltage swing of the op amp should be matched to the input voltage range of the Analog to Digital Converter (ADC). For the high side of the range this can be done by adjusting the gain of the op amp. However, the low side of the range can't be adjusted and is affected by the output swing of the op amp.

Example:

Assume the output voltage range of the sensor is 0 to 90 mV. The available op amp is a LMP7701, using a 0/+5V supply voltage, having an output drive of 50 mV from both rails. This results in an output range of 50 mV to 4.95V.

Let choose two resistors values for R_{G1} and R_{F1} that result in a gain of 50x. The output of the LMP7701 should swing from 0 mV to 4.5V. The higher value is no problem, however the lower swing is limited by the output of the LM7701 and won't go below 50 mV instead of the desired 0V, causing a non-linearity in the sensor reading. When using a 12 bit ADC, and a reference voltage of 5 Volt (having an ADC step size of approximate 1.2 mV), the output saturation results in a loss of the lower 40 quantization levels of the ADCs dynamic range.

Two-Stage, Single Supply True Zero Amplifier

This sensor application produces a DC signal, amplified by a two cascaded op amps, having a single supply. The output voltage of the second op amp is converted to the digital domain. Figure 9 shows the basic setup of this application.

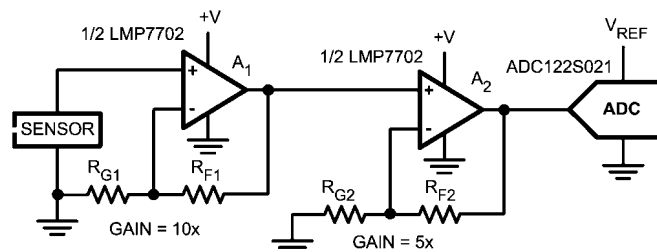

20173036

FIGURE 9. Sensor with DC Output and a 2-Stage, Single Supply Op Amp.

The sensor generates a DC output signal. In this case, a DC coupled, 2-stage amplifier is used. The output voltage swing of the second op amp should be matched to the input voltage range of the Analog to Digital Converter (ADC). For the high side of the range this can be done by adjusting the gain of the op amp. However, the low side of the range can't be adjusted and is affected by the output drive of the op amp.

Example:

Assume; the output voltage range of the sensor is 0 to 90 mV. The available op amp is a LMP7702 (Dual LMP7701 op amp) that can be used for A_1 and A_2 . The op amp is using a 0/+5V supply voltage, having an output drive of 50mV from both rails. This results in an output range of 50 mV to 4.95V for each individual amplifier.

Let choose two resistors values for R_{G1} and R_{F1} that result in a gain of 10x for the first stage (A_1) and a gain of 5x for the second stage (A_2). The output of the A_2 in the LMP7702 should swing from 0V to 4.5 Volt. This swing is limited by the 2 different factors:

1. The high voltage swing is no problem; however the low voltage swing is limited by the output saturation voltage of A_2 from the LM7702 and won't go below 50mV instead of the desired 0V.
2. Another effect has more impact. The output saturation voltage of the first stage will cause an offset for the input of the second stage. This offset of A_1 is amplified by the gain of the second stage (10x in this example), resulting in an output offset voltage of 500mV. This is significantly more than the 50 mV (V_{DSAT}) of A_2 .

When using a 12 bit ADC, and a reference voltage of 5 Volt (having an ADC step size of approximate 1.2 mV), the output saturation results in a loss of the lower 400 quantization levels of the ADCs dynamic range. This will cause a major non-linearity in the sensor reading.

Dual Supply, True Zero Amplifiers

The limitations of the output stage of the op amp, as indicated in both examples, can be omitted by using a dual supply op amp. The output stage of the used op amp can then still swing from 50 mV of the supply rails. However, the functional output range of the op amp is now from ground level to a value near the positive supply rail. *Figure 10* shows the output drive of an amplifier in a true zero output voltage application.

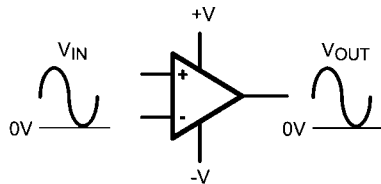

20173042

FIGURE 10. Amplifier output drive with a dual supply

Disadvantages of this solution are:

- The usage of a dual supply instead of a simple single supply is more expensive.
- A dual supply voltage for the op amps requires parts that can handle a larger operating range for the supply voltage. If the op amps used in the current solution can't handle this, a redesign can be required.

A better solution is to use the LM7705. This low noise negative bias generator has some major advantages with respect to a dual supply solution:

- Operates with only a single positive supply, and is therefore a much cheaper solution.
- The LM7705 generates a negative supply voltage of only $-0.23V$. This is more than enough to create a True-zero output for most op amps.
- In many applications, this "small" extension of the supply voltage range can be within the abs max rating for many op amps, so an expensive redesign is not necessary.

In the next section a typical amplifier application will be evaluated. The performance of an amplifier will be measured in a single supply configuration. The results will be compared with an amplifier using a LM7705 supplying a negative voltage to the bias pin.

TYPICAL AMPLIFIER APPLICATION

This section shows the measurement results of a true zero output amplifier application with an analog to digital converter (ADC) used as back-end. The biasing of the op amp can be done in two ways:

- A single supply configuration
- A single supply in combination with the LM7705, extending the negative supply from ground level to a fixed -0.23 Voltage.

Basic Setup

The basic setup of this true zero output amplifier is given in *Figure 11*. The LMP7701 op amp is configured as a voltage follower to demonstrate the output limitation, due to the saturation of the output stage. The negative power supply pin of the op amp can be connected to ground level or to the output of the negative bias generator, to demonstrate the V_{DSAT} effect at the output voltage range.

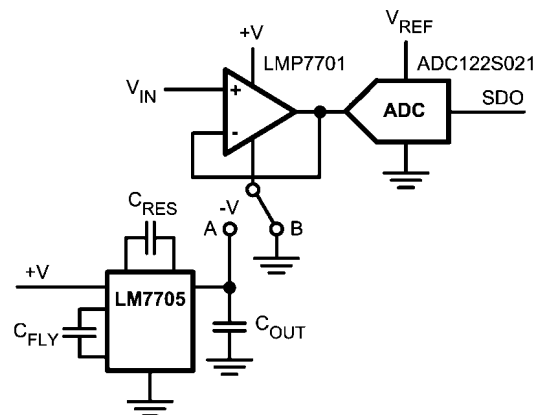

20173043

FIGURE 11. Typical True Zero Output Voltage Application with/without LM7705

The output voltage of the LMP7701 is converted to the digital domain using an ADC122S021. This is an 12 bit analog to digital converter with a serial data output. Data processing and graphical displaying is done with a computer. The negative power supply pin of the op amp can be connected to ground level or to the output of the negative bias generator, to demonstrate the effect at the output voltage range of the op amp.

The key specifications of the used components are given in the next part of the section.

Supply Voltage/Reference Voltage	
Supply voltage	+5V
ADC Voltage Reference	+5V
LMP7701	
V_{DSAT} (typical)	18 mV
V_{DSAT} (over temperature)	50 mV
LM7705	
Output voltage ripple	4 mV _{PP}
Output voltage noise	10 mV _{PP}
ADC	
Type	ADC122S021
Resolution	12 bit
Quantization level	$5V/4096 = 1.2mV$

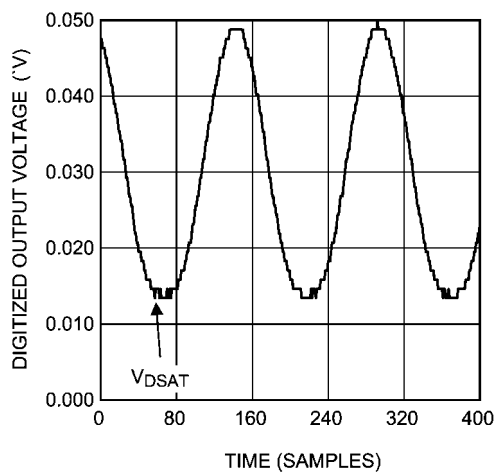

20173045

(A)

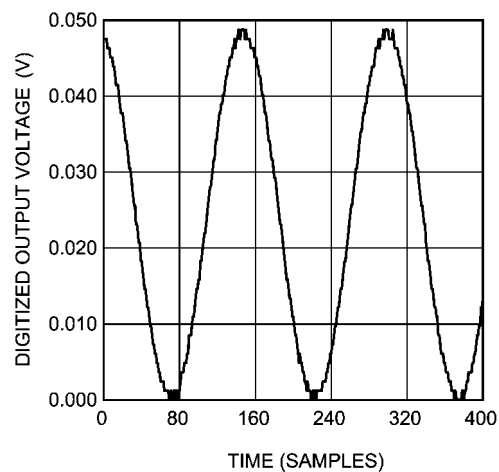

20173044

(B)

FIGURE 12. Digitized Output Voltage without (A) and with (B) LM7705

Figure 12A shows the digitized output voltage of the op amp when its negative supply pin is connected to ground level. The output of the amplifier saturates at a level of 14 mV (this is in line with the typical value of 18 mV given in the datasheet). The graph shows some fluctuations (1 bit quantization error). Figure 12B shows the digitized output voltage of the op amp when its negative supply pin is connected to the output of the LM7705. Again, the graph shows some 1 bit quantization errors caused by the voltage ripple and output noise. In this case the op amp's output level can reach the true zero output level.

The graphs in Figure 12 show that:

- With a single supply, the output of the amplifier is limited by the V_{DSAT} of the output stage.
- The amplifier can be used as a true zero output using a LM7705.
- The quantization error of the digitized output voltage is caused by the noise and the voltage ripple.

Measurement Results

The output voltage range of the LMP7701 has been measured, especially the range to ground level. A small DC signal, with a voltage swing of 50 mV_{PP} is applied to the input. The digitized output voltage of the op amp is measured over a given time period, when its negative supply pin is connected to ground level or connected to the output of the LM7705.

Figure 12A and Figure 12B show the digitized output voltage of the LMP7701 op amp.

- Using the LM7705 does not increase the quantization error in this set up.

DESIGN RECOMMENDATIONS

The LM7705 is a switched capacitor voltage inverter. This means that charge is transferred from different external capacitors, to generate a negative voltage. For this reason the part is very sensitive for contact resistance between the package and external capacitors. It's also recommended to use low ESR capacitors for C_{FLY} , C_{RES} and C_{OUT} in combination with short traces.

To prevent large variations at the V_{DD} pin of the package it is recommended to add a decouple capacitor as close to the pin as possible.

The output voltage noise can be suppressed using a small RF capacitor, with a value of e.g. 100 nF.

Physical Dimensions inches (millimeters) unless otherwise noted

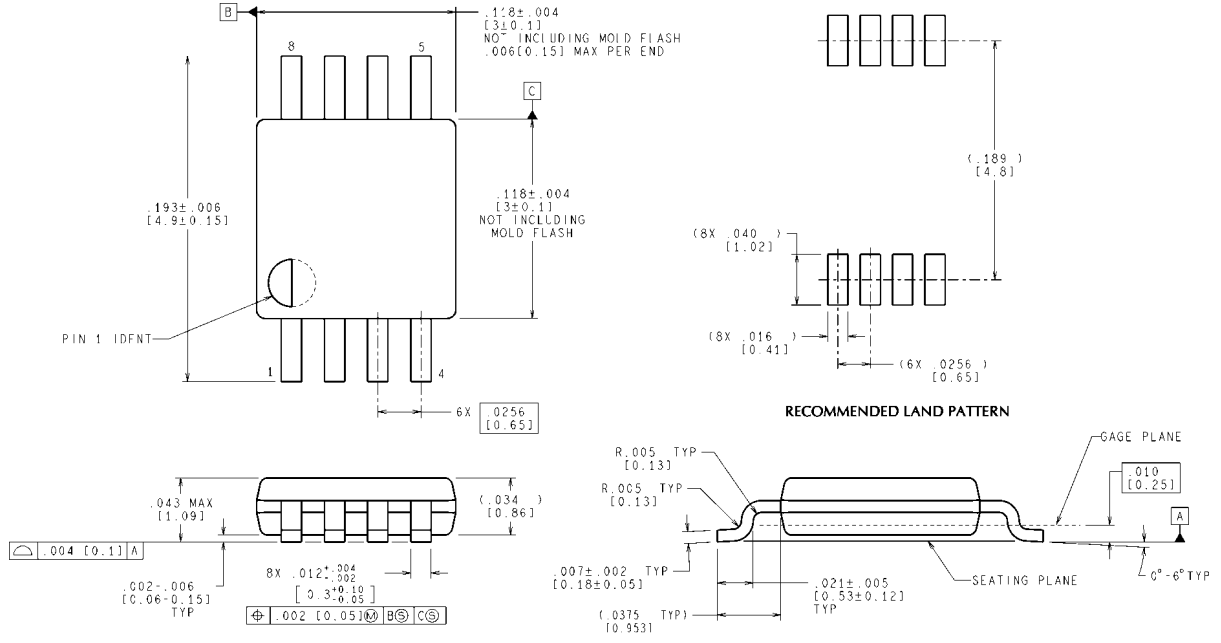

CONTROLLING DIMENSION IS INCH
VALUES IN [] ARE MILLIMETERS

MUA08A (Rev F)

8-Pin MSOP
NS Package Number MUA08A

Notes

LM7705

Notes

For more National Semiconductor product information and proven design tools, visit the following Web sites at:

Products		Design Support	
Amplifiers	www.national.com/amplifiers	WEBENCH® Tools	www.national.com/webench
Audio	www.national.com/audio	App Notes	www.national.com/appnotes
Clock and Timing	www.national.com/timing	Reference Designs	www.national.com/refdesigns
Data Converters	www.national.com/adc	Samples	www.national.com/samples
Interface	www.national.com/interface	Eval Boards	www.national.com/evalboards
LVDS	www.national.com/lvds	Packaging	www.national.com/packaging
Power Management	www.national.com/power	Green Compliance	www.national.com/quality/green
Switching Regulators	www.national.com/switchers	Distributors	www.national.com/contacts
LDOs	www.national.com/lido	Quality and Reliability	www.national.com/quality
LED Lighting	www.national.com/led	Feedback/Support	www.national.com/feedback
Voltage Reference	www.national.com/vref	Design Made Easy	www.national.com/easy
PowerWise® Solutions	www.national.com/powerwise	Solutions	www.national.com/solutions
Serial Digital Interface (SDI)	www.national.com/sdi	Mil/Aero	www.national.com/milaero
Temperature Sensors	www.national.com/tempensors	SolarMagic™	www.national.com/solarmagic
Wireless (PLL/VCO)	www.national.com/wireless	PowerWise® Design University	www.national.com/training

THE CONTENTS OF THIS DOCUMENT ARE PROVIDED IN CONNECTION WITH NATIONAL SEMICONDUCTOR CORPORATION ("NATIONAL") PRODUCTS. NATIONAL MAKES NO REPRESENTATIONS OR WARRANTIES WITH RESPECT TO THE ACCURACY OR COMPLETENESS OF THE CONTENTS OF THIS PUBLICATION AND RESERVES THE RIGHT TO MAKE CHANGES TO SPECIFICATIONS AND PRODUCT DESCRIPTIONS AT ANY TIME WITHOUT NOTICE. NO LICENSE, WHETHER EXPRESS, IMPLIED, ARISING BY ESTOPPEL OR OTHERWISE, TO ANY INTELLECTUAL PROPERTY RIGHTS IS GRANTED BY THIS DOCUMENT.

TESTING AND OTHER QUALITY CONTROLS ARE USED TO THE EXTENT NATIONAL DEEMS NECESSARY TO SUPPORT NATIONAL'S PRODUCT WARRANTY. EXCEPT WHERE MANDATED BY GOVERNMENT REQUIREMENTS, TESTING OF ALL PARAMETERS OF EACH PRODUCT IS NOT NECESSARILY PERFORMED. NATIONAL ASSUMES NO LIABILITY FOR APPLICATIONS ASSISTANCE OR BUYER PRODUCT DESIGN. BUYERS ARE RESPONSIBLE FOR THEIR PRODUCTS AND APPLICATIONS USING NATIONAL COMPONENTS. PRIOR TO USING OR DISTRIBUTING ANY PRODUCTS THAT INCLUDE NATIONAL COMPONENTS, BUYERS SHOULD PROVIDE ADEQUATE DESIGN, TESTING AND OPERATING SAFEGUARDS.

EXCEPT AS PROVIDED IN NATIONAL'S TERMS AND CONDITIONS OF SALE FOR SUCH PRODUCTS, NATIONAL ASSUMES NO LIABILITY WHATSOEVER, AND NATIONAL DISCLAIMS ANY EXPRESS OR IMPLIED WARRANTY RELATING TO THE SALE AND/OR USE OF NATIONAL PRODUCTS INCLUDING LIABILITY OR WARRANTIES RELATING TO FITNESS FOR A PARTICULAR PURPOSE, MERCHANTABILITY, OR INFRINGEMENT OF ANY PATENT, COPYRIGHT OR OTHER INTELLECTUAL PROPERTY RIGHT.

LIFE SUPPORT POLICY

NATIONAL'S PRODUCTS ARE NOT AUTHORIZED FOR USE AS CRITICAL COMPONENTS IN LIFE SUPPORT DEVICES OR SYSTEMS WITHOUT THE EXPRESS PRIOR WRITTEN APPROVAL OF THE CHIEF EXECUTIVE OFFICER AND GENERAL COUNSEL OF NATIONAL SEMICONDUCTOR CORPORATION. As used herein:

Life support devices or systems are devices which (a) are intended for surgical implant into the body, or (b) support or sustain life and whose failure to perform when properly used in accordance with instructions for use provided in the labeling can be reasonably expected to result in a significant injury to the user. A critical component is any component in a life support device or system whose failure to perform can be reasonably expected to cause the failure of the life support device or system or to affect its safety or effectiveness.

National Semiconductor and the National Semiconductor logo are registered trademarks of National Semiconductor Corporation. All other brand or product names may be trademarks or registered trademarks of their respective holders.

Copyright© 2009 National Semiconductor Corporation

For the most current product information visit us at www.national.com



**National Semiconductor
Americas Technical
Support Center**
Email: support@nsc.com
Tel: 1-800-272-9959

**National Semiconductor Europe
Technical Support Center**
Email: europe.support@nsc.com

**National Semiconductor Asia
Pacific Technical Support Center**
Email: ap.support@nsc.com

**National Semiconductor Japan
Technical Support Center**
Email: jpn.feedback@nsc.com