

LM776 Multi-Purpose Programmable Operational Amplifier

General Description

The LM776 Programmable Operational Amplifier is constructed using the Planar Epitaxial process. High input impedance, low supply currents, and low input noise over a wide range of operating supply voltages coupled with programmable electrical characteristics result in an extremely versatile amplifier for use in high accuracy, low power consumption analog applications. Input noise voltage and current, power consumption, and input current can be optimized by a single resistor or current source that sets the chip quiescent current for nano watt power consumption or for characteristics similar to the LM741. Internal frequency compensation, absence of latch up, high slew rate and short circuit current protection assure ease of use in long time integrators, active filters, and sample and hold circuits.

Features

- Micropower consumption
- $\pm 1.2V$ to $\pm 18V$ operation
- No frequency compensation required
- Low input bias currents
- Wide programming range
- High slew rate
- Low noise
- Short circuit protection
- Offset null capability
- No latch up

Applications

- Battery-powered instrumentation
- High-gain amp
- Filters
- Sample-and-Hold

Connection Diagrams

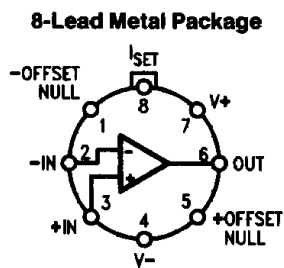

Top View

TL/H/10073-1

Lead 4 connected to case.

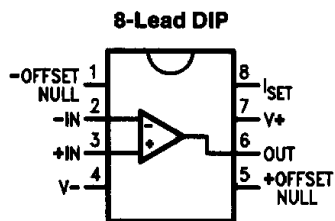

Top View

TL/H/10073-2

Ordering Information

Device Code	Package Code	Package Description
LM776H	H08A	Metal
LM776CH	H08A	Metal
LM776CN	N08E	Molded DIP

Absolute Maximum Ratings

If Military/Aerospace specified devices are required, please contact the National Semiconductor Sales Office/Distributors for availability and specifications.

Storage Temperature Range		
Metal Can		-65°C to +175°C
Molded DIP		-65°C to +150°C
Operating Temperature Range		
Extended (LM776M)		-55°C to +125°C
Commercial (LM776C)		0°C to +70°C
Lead Temperature		
Metal Can (Soldering, 60 sec.)		300°C
Molded DIP (Soldering, 10 sec.)		265°C
Internal Power Dissipation (Notes 1, 2)		
8L-Metal Can		1.00W
8L-Molded DIP		0.93W

Supply Voltage	±18V
Differential Input Voltage	±30V
Input Voltage (Note 3)	±15V
Voltage Between Offset Null and V-	±0.5V
Output Short Circuit Duration (Note 4)	Indefinite
I _{SET} (Maximum Current at I _{SET})	500 μA
V _{SET} (Maximum Voltage to Ground at I _{SET})	(V ⁺ - 2.0V) ≤ V _{SET} ≤ V ⁺
ESD Tolerance	(to be determined)

LM776

Electrical Characteristics $T_A = 25^\circ\text{C}$, $V_{CC} = \pm 15\text{V}$, unless otherwise specified

Symbol	Parameter	Conditions	I _{SET} = 1.5 μA			I _{SET} = 15 μA			Units
			Min	Typ	Max	Min	Typ	Max	
V _{IO}	Input Offset Voltage	R _S ≤ 10 kΩ		2.0	5.0		2.0	5.0	mV
V _{IO adj}	Input Offset Voltage Adjustment Range			9.0			18		mV
I _{IO}	Input Offset Current			0.7	3.0		2.0	15	nA
I _B	Input Bias Current			2.0	7.5		15	50	nA
Z _I	Input Impedance			50			5.0		MΩ
I _{CC}	Supply Current			20	25		160	180	μA
P _c	Power Consumption				0.75			5.4	mW
I _{OS}	Output Short Circuit Current			3.0			12		mA
A _{VS}	Large Signal Voltage Gain	V _O = ±10V, R _L ≥ 75 kΩ	200	400					V/mV
		V _O = ±10V, R _L ≥ 5.0 kΩ				100	400		
V _{OP}	Output Voltage Swing	R _L = 75 kΩ	±12	±14					V
		R _L = 5.0 kΩ				±10	±13		
TR	Transient Response	Rise Time	V _I = 20 mV, R _L = 5.0 kΩ, C _L = 100 pF, A _V = 1.0	1.6			0.35		μs
		Overshoot		0			10		%
SR	Slew Rate	R _L = 5.0 kΩ, A _V = 1.0		0.1			0.8		V/μs

The following specifications apply -55°C ≤ T_A ≤ +125°C

V _{IO}	Input Offset Voltage	R _S ≤ 10 kΩ			6.0			6.0	mV
I _{IO}	Input Offset Current	T _A = +125°C			5.0			15	nA
		T _A = -55°C			10			40	
I _B	Input Bias Current	T _A = +125°C			7.5			50	nA
		T _A = -55°C			20			120	
I _{CC}	Supply Current				30			200	μA
P _c	Power Consumption				0.9			6.0	mW
CMR	Common Mode Rejection	R _S ≤ 10 kΩ	70	90		70	90		dB
V _{IR}	Input Voltage Range		±10			±10			V
PSRR	Power Supply Rejection Ratio	R _S ≤ 10 kΩ		25	150		25	150	μV/V
A _{VS}	Large Signal Voltage Gain	V _O = +10V, R _L ≥ 75 kΩ	100			75			V/mV
V _{OP}	Output Voltage Swing	R _L = 75 kΩ	±10			±10			V

LM776

Electrical Characteristics $T_A = 25^\circ\text{C}$, $V_{CC} = \pm 3.0\text{V}$, unless otherwise specified

Symbol	Parameter	Conditions	$I_{SET} = 1.5 \mu\text{A}$			$I_{SET} = 15 \mu\text{A}$			Units
			Min	Typ	Max	Min	Typ	Max	
V_{IO}	Input Offset Voltage	$R_S \leq 10 \text{ k}\Omega$		2.0	5.0		2.0	5.0	mV
$V_{IO \text{ adj}}$	Input Offset Voltage Adjustment Range			9.0			18		mV
I_{IO}	Input Offset Current			0.7	3.0		2.0	15	nA
I_{IB}	Input Bias Current			2.0	7.5		15	50	nA
Z_I	Input Impedance			50			5.0		M Ω
I_{CC}	Supply Current			13	20		130	160	μA
P_c	Power Consumption			78	120		780	960	μW
I_{OS}	Output Short Circuit Current			3.0			5.0		mA
A_{VS}	Large Signal Voltage Gain	$V_O = \pm 1.0\text{V}$, $R_L \geq 75 \text{ k}\Omega$	50	200					V/mV
		$V_O = \pm 1.0\text{V}$, $R_L \geq 5.0 \text{ k}\Omega$				50	200		
TR	Transient Response	Rise Time	$V_I = 20 \text{ mV}$, $R_L = 5.0 \text{ k}\Omega$, $C_L = 100 \text{ pF}$, $A_V = 1.0$	3.0			0.6		μs
		Overshoot		0			5		%
SR	Slew Rate	$R_L = 5.0 \text{ k}\Omega$, $A_V = 1.0$		0.03			0.35		V/ μs

The following specifications apply $-55^\circ\text{C} \leq T_A \leq +125^\circ\text{C}$

V_{IO}	Input Offset Voltage	$R_S \leq 10 \text{ k}\Omega$			6.0			6.0	mV
I_{IO}	Input Offset Current	$T_A = +125^\circ\text{C}$			5.0			15	nA
		$T_A = -55^\circ\text{C}$			10			40	
I_{IB}	Input Bias Current	$T_A = +125^\circ\text{C}$			7.5			50	nA
		$T_A = -55^\circ\text{C}$			20			120	
I_{CC}	Supply Current				25			180	μA
P_c	Power Consumption				150			1080	μW
CMR	Common Mode Rejection	$R_S \leq 10 \text{ k}\Omega$	70	86		70	86		dB
V_{IR}	Input Voltage Range		± 1.0			± 1.0			V
PSRR	Power Supply Rejection Ratio	$R_S \leq 10 \text{ k}\Omega$		25	150		25	150	$\mu\text{V/V}$
A_{VS}	Large Signal Voltage Gain	$V_O = \pm 1.0\text{V}$, $R_L \geq 75 \text{ k}\Omega$	25						V/mV
		$V_O = \pm 1.0\text{V}$, $R_L \geq 5.0 \text{ k}\Omega$				25			
V_{OP}	Output Voltage Swing	$R_L = 75 \text{ k}\Omega$	± 2.0	± 2.4					V
		$R_L = 5.0 \text{ k}\Omega$				± 1.9	± 2.1		

Note 1: $T_{J \text{ Max}} = 150^\circ\text{C}$ for the Molded DIP, and 175°C for the Metal Can.

Note 2: Ratings apply to ambient temperature at 25°C . Above this temperature, derate the 8L-Metal Can at $6.7 \text{ mW}/^\circ\text{C}$, and the 8L-Molded DIP at $7.5 \text{ mW}/^\circ\text{C}$.

Note 3: For supply voltages less than $\pm 15\text{V}$, the absolute maximum input voltage is equal to the supply voltage.

Note 4: Short Circuit may be to ground or either supply. Rating applies to 125°C case temperature or 75°C ambient temperature for $I_{SET} \leq 30 \mu\text{A}$.

LM776C

Electrical Characteristics $T_A = 25^\circ\text{C}$, $V_{CC} = \pm 15\text{V}$, unless otherwise specified

Symbol	Parameter	Conditions	$I_{SET} = 1.5 \mu\text{A}$			$I_{SET} = 15 \mu\text{A}$			Units
			Min	Typ	Max	Min	Typ	Max	
V_{IO}	Input Offset Voltage	$R_S \leq 10 \text{ k}\Omega$		2.0	6.0		2.0	6.0	mV
$V_{IO \text{ adj}}$	Input Offset Voltage Adjustment Range			9.0			18		mV
I_{IO}	Input Offset Current			0.7	6.0		2.0	25	nA
I_{IB}	Input Bias Current			2.0	10		15	50	nA
Z_I	Input Impedance			50			5.0		M Ω
I_{CC}	Supply Current			20	30		160	190	μA
P_c	Power Consumption				0.9			5.7	mW
I_{OS}	Output Short Circuit Current			3.0			12		mA
A_{VS}	Large Signal Voltage Gain	$V_O = \pm 10\text{V}$, $R_L \geq 75 \text{ k}\Omega$	50	400					V/mV
		$V_O = \pm 10\text{V}$, $R_L \geq 5.0 \text{ k}\Omega$				50	400		
V_{OP}	Output Voltage Swing	$R_L = 75 \text{ k}\Omega$	± 12	± 14					V
		$R_L = 5.0 \text{ k}\Omega$				± 10	± 13		
TR	Transient Response	Rise Time	$V_I = 20 \text{ mV}$, $R_L \geq 5.0 \text{ k}\Omega$, $C_L = 100 \text{ pF}$, $A_V = 1.0$	1.6			0.35		μs
		Overshoot		0			10		%
SR	Slew Rate	$R_L = 5.0 \text{ k}\Omega$, $A_V = 1.0$		0.1			0.8		V/ μs

The following specifications apply $0^\circ\text{C} \leq T_A \leq +70^\circ\text{C}$

V_{IO}	Input Offset Voltage	$R_S \leq 10 \text{ k}\Omega$			7.5			7.5	mV
I_{IO}	Input Offset Current	$T_A = 70^\circ\text{C}$			6.0			25	nA
		$T_A = 0^\circ\text{C}$			10			40	
I_{IB}	Input Bias Current	$T_A = 70^\circ\text{C}$			10			50	nA
		$T_A = 0^\circ\text{C}$			20			100	
I_{CC}	Supply Current				35			200	μA
P_c	Power Consumption				1.05			6.0	mW
CMR	Common Mode Rejection	$R_S \leq 10 \text{ k}\Omega$	70	90			70	90	dB
V_{IR}	Input Voltage Range		± 10				± 10		V
PSRR	Power Supply Rejection Ratio	$R_S \leq 10 \text{ k}\Omega$		25	200		25	200	$\mu\text{V}/\text{V}$
A_{VS}	Large Signal Voltage Gain	$V_O = \pm 10\text{V}$, $R_L \geq 75 \text{ k}\Omega$	50				50		V/mV
V_{OP}	Output Voltage Swing	$R_L = 75 \text{ k}\Omega$	± 10				± 10		V

LM776C

Electrical Characteristics $T_A = 25^\circ\text{C}$, $V_{CC} = \pm 3.0\text{V}$, unless otherwise specified

Symbol	Parameter	Conditions	$I_{SET} = 1.5 \mu\text{A}$			$I_{SET} = 15 \mu\text{A}$			Units
			Min	Typ	Max	Min	Typ	Max	
V_{IO}	Input Offset Voltage	$R_S \leq 10 \text{ k}\Omega$		2.0	6.0		2.0	6.0	mV
$V_{IO \text{ adj}}$	Input Offset Voltage Adjustment Range			9.0			18		mV
I_{IO}	Input Offset Current			0.7	6.0		2.0	25	nA
I_{IB}	Input Bias Current			2.0	10		15	50	nA
Z_I	Input Impedance			50			5.0		M Ω
I_{CC}	Supply Current			13	20		130	170	μA
P_c	Power Consumption			78	120		780	1020	μW
I_{OS}	Output Short Circuit Current			3.0			5.0		mA
A_{VS}	Large Signal Voltage Gain	$V_O = \pm 1.0\text{V}$, $R_L \geq 75 \text{ k}\Omega$	25	200					V/mV
		$V_O = \pm 1.0\text{V}$, $R_L \geq 5.0 \text{ k}\Omega$				25	200		
TR	Transient Response	Rise Time Overshoot	$V_I = 20 \text{ mV}$, $R_L \geq 5.0 \text{ k}\Omega$, $C_L = 100 \text{ pF}$, $A_V = 1.0$		3.0			0.6	μs
					0			5	%
SR	Slew Rate	$R_L = 5.0 \text{ k}\Omega$, $A_V = 1.0$		0.03			0.35		V/ μs

The following specifications apply $0^\circ\text{C} \leq T_A \leq +70^\circ\text{C}$

V_{IO}	Input Offset Voltage	$R_S \leq 10 \text{ k}\Omega$			7.5			7.5	mV
I_{IO}	Input Offset Current	$T_A = 70^\circ\text{C}$			6.0			25	nA
		$T_A = 0^\circ\text{C}$			10			40	
I_{IB}	Input Bias Current	$T_A = 70^\circ\text{C}$			10			50	nA
		$T_A = 0^\circ\text{C}$			20			100	
I_{CC}	Supply Current				25			180	μA
P_c	Power Consumption				150			1080	μW
CMR	Common Mode Rejection	$R_S \leq 10 \text{ k}\Omega$	70	86		70	86		dB
V_{IR}	Input Voltage Range		± 1.0			± 1.0			V
PSRR	Power Supply Rejection Ratio	$R_S \leq 10 \text{ k}\Omega$		25	200		25	200	$\mu\text{V/V}$
A_{VS}	Large Signal Voltage Gain	$V_O = \pm 1.0\text{V}$, $R_L \geq 75 \text{ k}\Omega$	25						V/mV
		$V_O = \pm 1.0\text{V}$, $R_L \geq 5.0 \text{ k}\Omega$				25			
V_{OP}	Output Voltage Swing	$R_L = 75 \text{ k}\Omega$	± 2.0	± 2.4					V
		$R_L = 5.0 \text{ k}\Omega$				± 2.0	± 2.1		

Equivalent Circuit

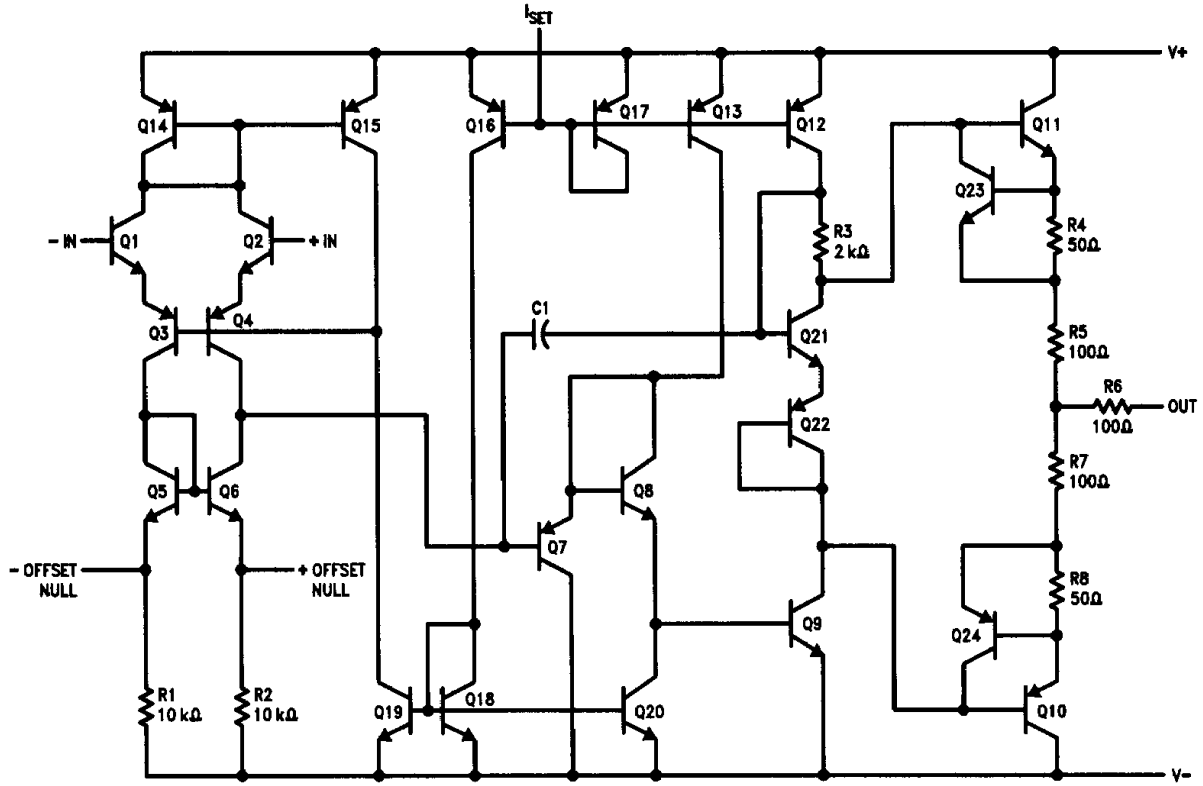

TL/H/10073-3

Typical Performance Characteristics for LM776 and LM776C

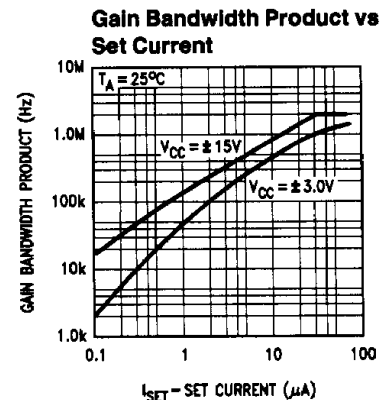
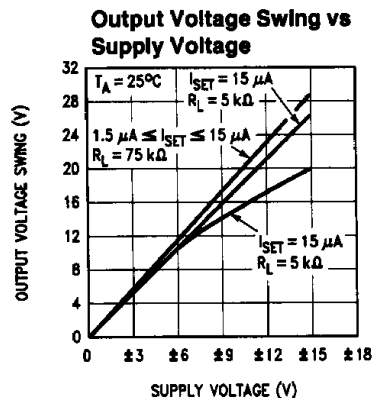
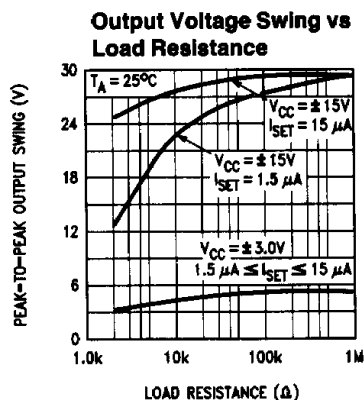
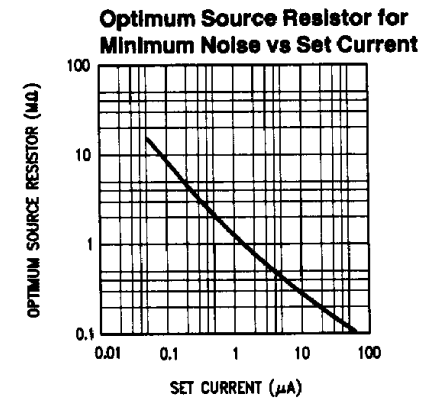
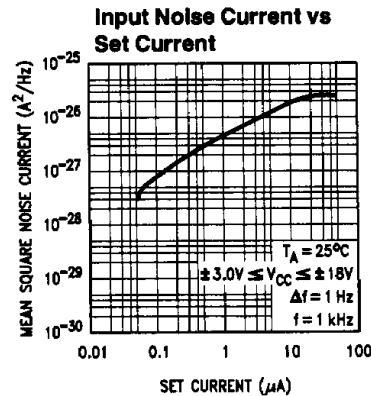
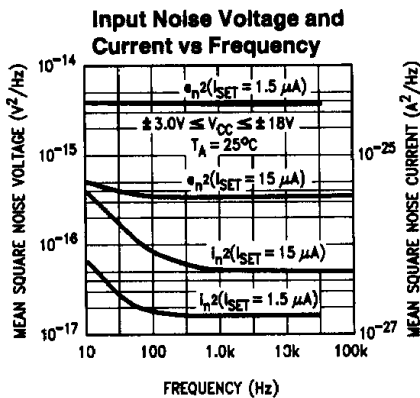
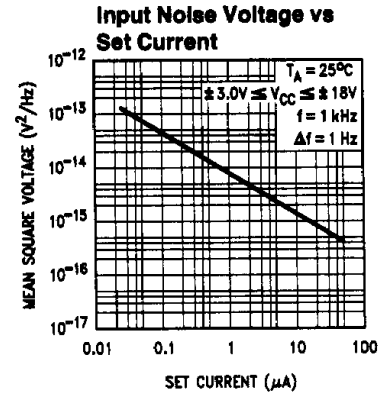
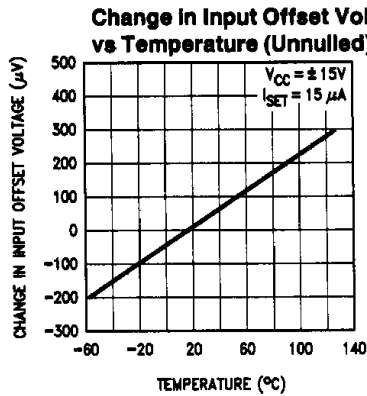
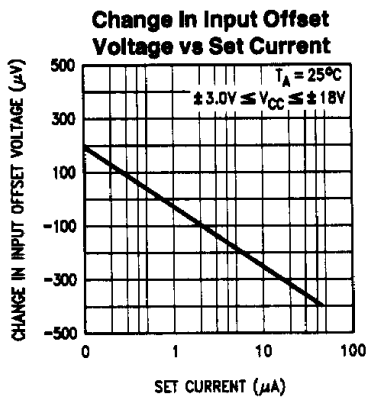
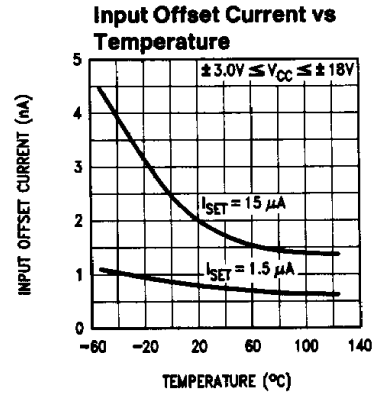
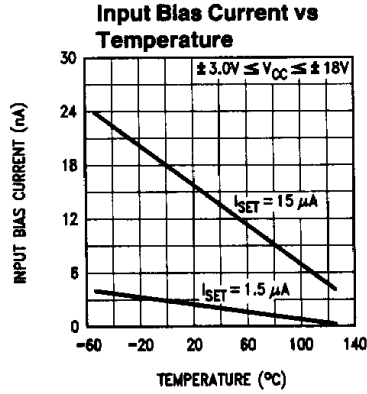
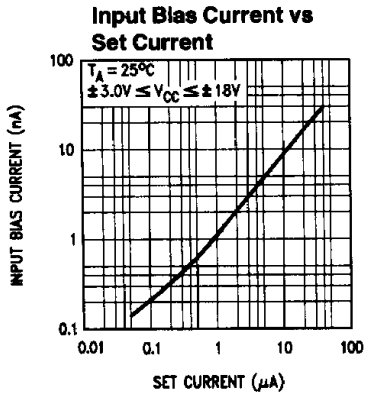

Typical Performance Characteristics for LM776 and LM776C (Continued)

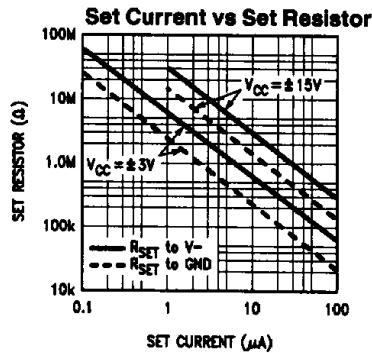
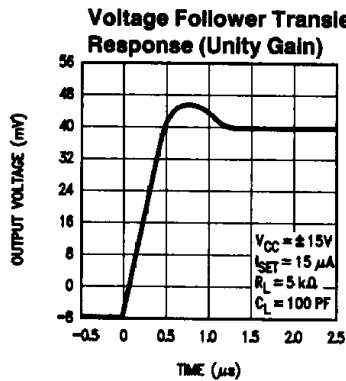
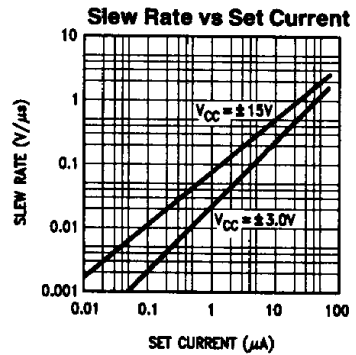
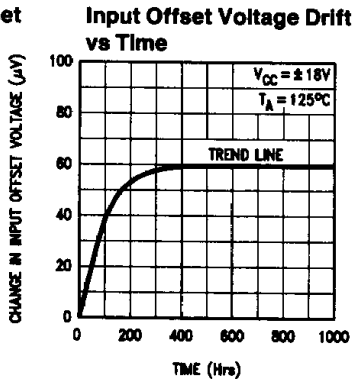
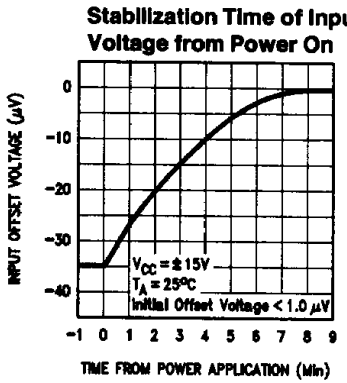
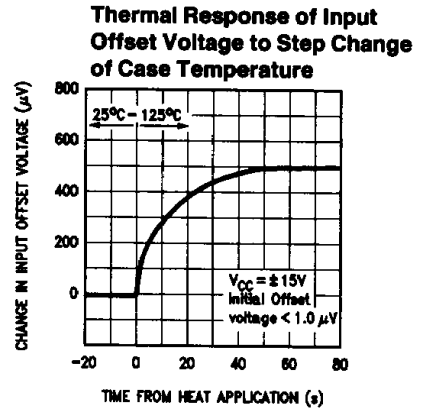
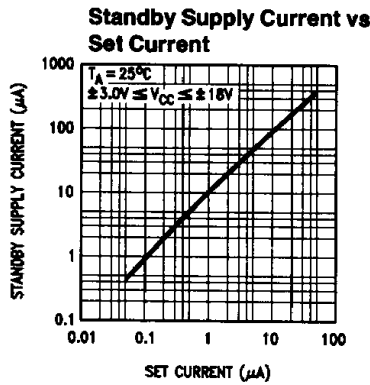
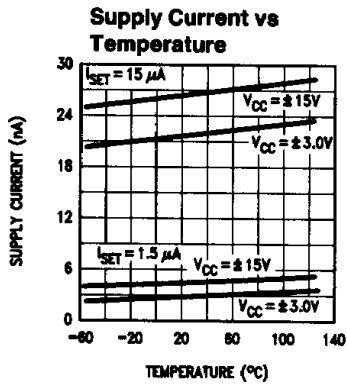
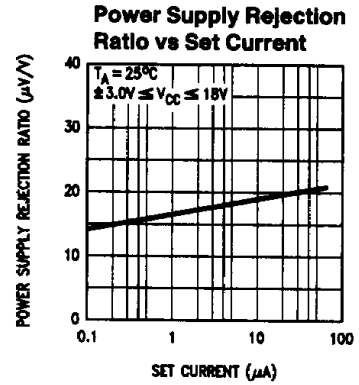
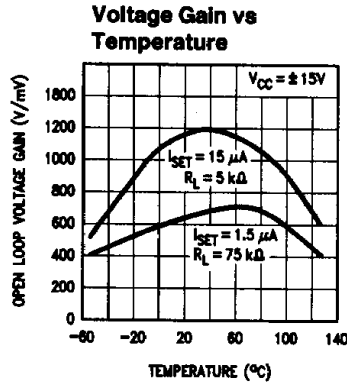
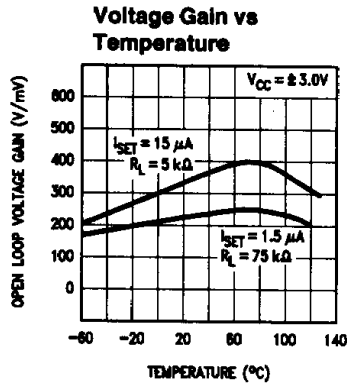

Applications Information

Quiescent Current Setting Resistor (I_{SET} to V⁻)

V _S	I _{SET}	
	1.5 μA	15 μA
±1.5V	1.7 MΩ	170 kΩ
±3.0V	3.6 MΩ	360 kΩ
±6.0V	7.5 MΩ	750 kΩ
±15V	20 MΩ	2.0 MΩ

Note: The LM776 may be operated with R_{SET} connected to ground or V⁻.

I_{SET} Equations

$$I_{SET} = \frac{(V^+) - 0.7 - (V^-)}{R_{SET}}$$

where:

R_{SET} is connected to V⁻

$$I_{SET} = \frac{(V^+) - 0.7}{R_{SET}}$$

where:

R_{SET} is connected to ground.

Biasing Circuits

Resistor Biasing

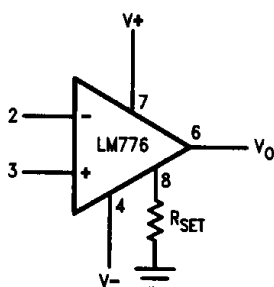

TL/H/10073-6

R_{SET} Connected to Ground

Voltage Offset Null Circuit

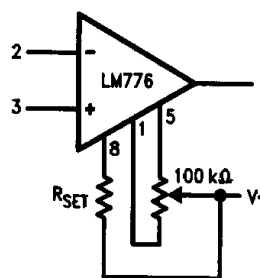

TL/H/10073-9

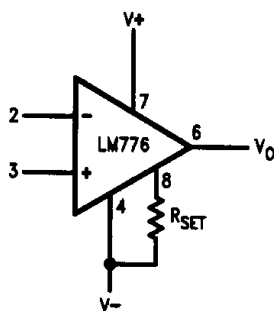

TL/H/10073-7

R_{SET} Connected to V⁻

*Recommended for supply voltages less than ±6V.

FET Current Source Biasing

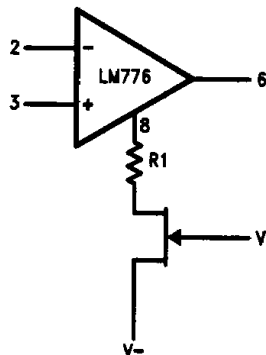

TL/H/10073-10

Transistor Current Biasing

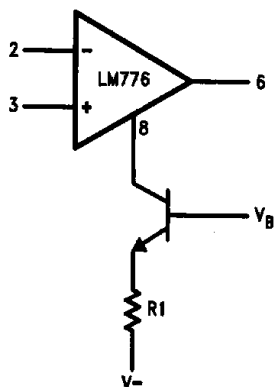

TL/H/10073-8

Transient Response Test Circuit

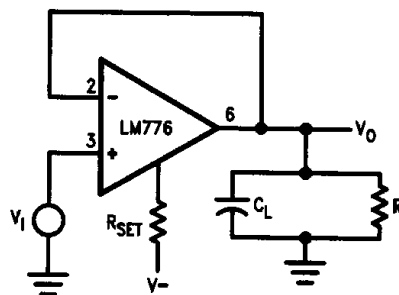

TL/H/10073-11