

n FEATURES

- Ψ Wide V_{CC} low operation voltage : 1.65V ~ 3.6V
- Ψ Ultra low power consumption :
 - $V_{CC} = 3.0V$ Operation current : 5.0mA at 70ns at 25°C
1.5mA at 1MHz at 25°C
 - Standby current : 3uA at 25°C
 - $V_{CC} = 2.0V$ Data retention current : 3uA at 25°C
- Ψ High speed access time :
 - 70 70ns at 1.8V at 85°C
- Ψ Automatic power down when chip is deselected
- Ψ Easy expansion with CE1, CE2 and OE options
- Ψ I/O Configuration x8/x16 selectable by LB and UB pin.
- Ψ Three state outputs and TTL compatible
- Ψ Fully static operation, no clock, no refresh
- Ψ Data retention supply voltage as low as 1.0V

n DESCRIPTION

The BH616UV1610 is a high performance, ultra low power CMOS Static Random Access Memory organized as 1,048,576 by 16 bits and operates in a wide range of 1.65V to 3.6V supply voltage. Advanced CMOS technology and circuit techniques provide both high speed and low power features with typical operating current of 1.5mA at 1MHz at 3.0V/25°C and maximum access time of 70ns at 1.8V/85°C. Easy memory expansion is provided by an active LOW chip enable ($\overline{CE1}$), an active HIGH chip enable (CE2) and active LOW output enable (\overline{OE}) and three-state output drivers.

The BH616UV1610 has an automatic power down feature, reducing the power consumption significantly when chip is deselected. The BH616UV1610 is made with two chips of 8Mbit SRAM by stacked multi-chip-package.

The BH616UV1610 is available in 48-ball BGA package.

n PRODUCT FAMILY

PRODUCT FAMILY	OPERATING TEMPERATURE	V_{CC} RANGE	SPEED (ns)	POWER CONSUMPTION				PKG TYPE
				STANDBY ($I_{CCS81, Max}$)		Operating ($I_{CC, Max}$)		
				$V_{CC}=1.8\sim3.6V$	$V_{CC}=3.6V$	$V_{CC}=1.8V$	$V_{CC}=3.6V$	
BH616UV1610AI	+0°C to +70°C	1.65V ~ 3.6V	70	20uA	15uA	10mA	7mA	BGA-48-0608
	-25°C to +85°C		70	25uA	20uA	10mA	7mA	

n PIN CONFIGURATIONS

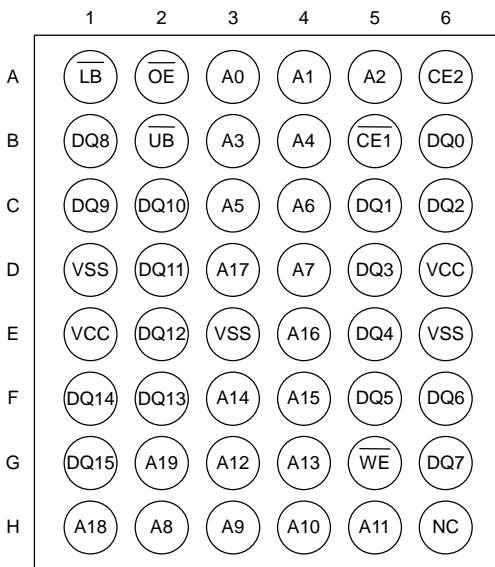

48-ball BGA top view

n BLOCK DIAGRAM

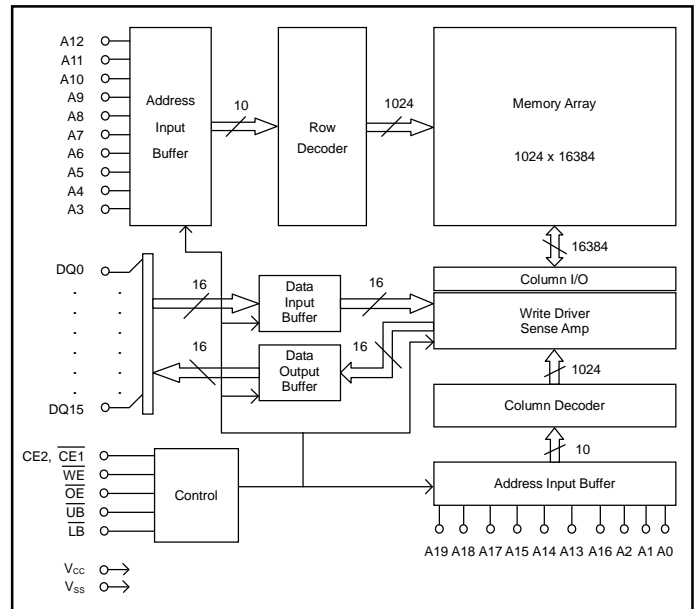

Brilliance Semiconductor, Inc. reserves the right to modify document contents without notice.
Detailed product characteristic test report is available upon request and being accepted.

n PIN DESCRIPTIONS

Name	Function
A0-A19 Address Input	These 20 address inputs select one of the 1,048,576 x 16 bit in the RAM
$\overline{\text{CE1}}$ Chip Enable 1 Input $\overline{\text{CE2}}$ Chip Enable 2 Input	$\overline{\text{CE1}}$ is active LOW and $\overline{\text{CE2}}$ is active HIGH. Both chip enables must be active when data read from or write to the device. If either chip enable is not active, the device is deselected and is in standby power mode. The DQ pins will be in the high impedance state when the device is deselected.
$\overline{\text{WE}}$ Write Enable Input	The write enable input is active LOW and controls read and write operations. With the chip selected, when $\overline{\text{WE}}$ is HIGH and $\overline{\text{OE}}$ is LOW, output data will be present on the DQ pins; when $\overline{\text{WE}}$ is LOW, the data present on the DQ pins will be written into the selected memory location.
$\overline{\text{OE}}$ Output Enable Input	The output enable input is active LOW. If the output enable is active while the chip is selected and the write enable is inactive, data will be present on the DQ pins and they will be enabled. The DQ pins will be in the high impedance state when $\overline{\text{OE}}$ is inactive.
$\overline{\text{LB}}$ and $\overline{\text{UB}}$ Data Byte Control Input	Lower byte and upper byte data input/output control pins.
DQ0-DQ15 Data Input/Output Ports	16 bi-directional ports are used to read data from or write data into the RAM.
V_{CC}	Power Supply
V_{SS}	Ground

n TRUTH TABLE

MODE	$\overline{\text{CE1}}$	$\overline{\text{CE2}}$	$\overline{\text{WE}}$	$\overline{\text{OE}}$	$\overline{\text{LB}}$	$\overline{\text{UB}}$	DQ0~DQ7	DQ8~DQ15	V_{CC} CURRENT
Chip De-selected (Power Down)	H	X	X	X	X	X	High Z	High Z	I_{CCSB} , I_{CCSB1}
	X	L	X	X	X	X	High Z	High Z	I_{CCSB} , I_{CCSB1}
	X	X	X	X	H	H	High Z	High Z	I_{CCSB} , I_{CCSB1}
Output Disabled	L	H	H	H	X	X	High Z	High Z	I_{CC}
Read	L	H	H	L	L	L	D_{OUT}	D_{OUT}	I_{CC}
					H	L	High Z	D_{OUT}	I_{CC}
					L	H	D_{OUT}	High Z	I_{CC}
Write	L	H	L	X	L	L	D_{IN}	D_{IN}	I_{CC}
					H	L	X	D_{IN}	I_{CC}
					L	H	D_{IN}	X	I_{CC}

NOTES: H means V_{IH} ; L means V_{IL} ; X means don't care (Must be V_{IH} or V_{IL} state)

n ABSOLUTE MAXIMUM RATINGS ⁽¹⁾

SYMBOL	PARAMETER	RATING	UNITS
V _{TERM}	Terminal Voltage with Respect to GND	-0.5 ⁽²⁾ to 4.6V	V
T _{BIAS}	Temperature Under Bias	-40 to +125	°C
T _{STG}	Storage Temperature	-60 to +150	°C
P _T	Power Dissipation	1.0	W
I _{OUT}	DC Output Current	20	mA

- Stresses greater than those listed under ABSOLUTE MAXIMUM RATINGS may cause permanent damage to the device. This is a stress rating only and functional operation of the device at these or any other conditions above those indicated in the operational sections of this specification is not implied. Exposure to absolute maximum rating conditions for extended periods may affect reliability.
- 2.0V in case of AC pulse width less than 30 ns

n OPERATING RANGE

RANG	AMBIENT TEMPERATURE	V _{CC}
Commercial	0°C to +70°C	1.65V ~ 3.6V
Industrial	-25°C to +85°C	1.65V ~ 3.6V

n CAPACITANCE ⁽¹⁾ (T_A = 25°C, f = 1.0MHz)

SYMBOL	PARAMETER	CONDITIONS	MAX.	UNITS
C _{IN}	Input Capacitance	V _{IN} = 0V	10	pF
C _{IO}	Input/Output Capacitance	V _{I/O} = 0V	15	pF

- This parameter is guaranteed and not 100% tested.

n DC ELECTRICAL CHARACTERISTICS (T_A = -25°C to +85°C)

PARAMETER NAME	PARAMETER	TEST CONDITIONS	MIN.	TYP. ⁽¹⁾	MAX.	UNITS
V _{CC}	Power Supply		1.65	--	3.6	V
V _{IL}	Input Low Voltage	V _{CC} =1.8V	-0.3 ⁽²⁾	--	0.4	V
		V _{CC} =3.6V			0.8	
V _{IH}	Input High Voltage	V _{CC} =1.8V	1.4	--	V _{CC} +0.3 ⁽³⁾	V
		V _{CC} =3.6V	2.0			
I _{IL}	Input Leakage Current	V _{IN} = 0V to V _{CC} , CE1 = V _{IH} or CE2 = V _{IL}	--	--	1	µA
I _{LO}	Output Leakage Current	V _{I/O} = 0V to V _{CC} , CE1 = V _{IH} or CE2 = V _{IL} or OE = V _{IH} or UB = LB = V _{IH}	--	--	1	µA
V _{OL}	Output Low Voltage	V _{CC} = Max, I _{OL} = 0.2mA	V _{CC} =1.8V	--	0.2	V
		V _{CC} = Max, I _{OL} = 2.0mA	V _{CC} =3.6V		0.4	
V _{OH}	Output High Voltage	V _{CC} = Min, I _{OH} = -0.1mA	V _{CC} =1.8V	V _{CC} -0.2	--	V
		V _{CC} = Min, I _{OH} = -1.0mA	V _{CC} =3.6V	2.4		
I _{CC}	Operating Power Supply Current	CE1 = V _{IL} and CE2 = V _{IH} , I _{DQ} = 0mA, f = F _{MAX} ⁽⁴⁾	V _{CC} =1.8V	--	4.5	mA
			V _{CC} =3.6V		5.0	
I _{CC1}	Operating Power Supply Current	CE1 = V _{IL} and CE2 = V _{IH} , I _{DQ} = 0mA, f = 1MHz	V _{CC} =1.8V	--	1.0	mA
			V _{CC} =3.6V		1.5	
I _{CCSB}	Standby Current – TTL	CE1 = V _{IH} , or CE2 = V _{IL} , I _{DQ} = 0mA	V _{CC} =1.8V	--	0.5	mA
			V _{CC} =3.6V		1.0	
I _{CCSB1} ⁽⁵⁾	Standby Current – CMOS	CE1 ≥ V _{CC} -0.2V or CE2 ≤ 0.2V, V _{IN} ≥ V _{CC} -0.2V or V _{IN} ≤ 0.2V	V _{CC} =1.8V	--	3.0	µA
			V _{CC} =3.6V		3.0	

- Typical characteristics are at T_A=25°C.
- Undershoot: -1.0V in case of pulse width less than 20 ns.
- Overshoot: V_{CC}+1.0V in case of pulse width less than 20 ns.
- F_{MAX}=1/t_{RC}.
- I_{CCSB1(MAX)} is 15µA/20µA at V_{CC}=1.8V/3.6V and T_A=0°C ~ 70°C.

n DATA RETENTION CHARACTERISTICS ($T_A = -25^{\circ}\text{C}$ to $+85^{\circ}\text{C}$)

SYMBOL	PARAMETER	TEST CONDITIONS	MIN.	TYP. ⁽¹⁾	MAX.	UNITS
V_{DR}	V_{CC} for Data Retention	$CE1 \geq V_{CC}-0.2V$ or $CE2 \leq 0.2V$, $V_{IN} \geq V_{CC}-0.2V$ or $V_{IN} \leq 0.2V$	1.0	--	--	V
$I_{CCDR}^{(3)}$	Data Retention Current	$CE1 \geq V_{CC}-0.2V$ or $CE2 \leq 0.2V$, $V_{IN} \geq V_{CC}-0.2V$ or $V_{IN} \leq 0.2V$	--	1.0 3.0	7.0 20	μA
t_{CDR}	Chip Deselect to Data Retention Time	See Retention Waveform	0	--	--	ns
t_R	Operation Recovery Time		$t_{RC}^{(2)}$	--	--	ns

- $T_A=25^{\circ}\text{C}$.
- t_{RC} = Read Cycle Time.
- $I_{CCDR(MAX)}$ is 6.0 μA /15 μA at $V_{CC}=1.0V/2.0V$ and $T_A=0^{\circ}\text{C} \sim 70^{\circ}\text{C}$.

n LOW V_{CC} DATA RETENTION WAVEFORM (1) ($\overline{CE1}$ Controlled)

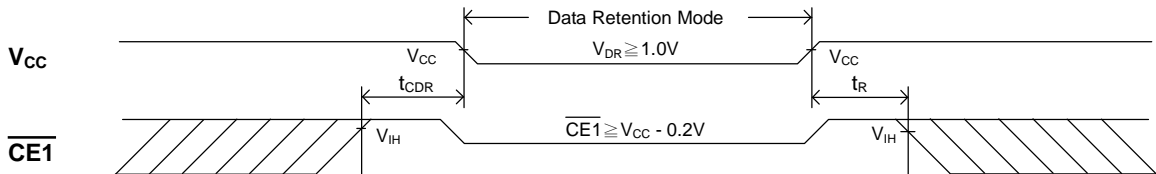

n LOW V_{CC} DATA RETENTION WAVEFORM (2) ($CE2$ Controlled)

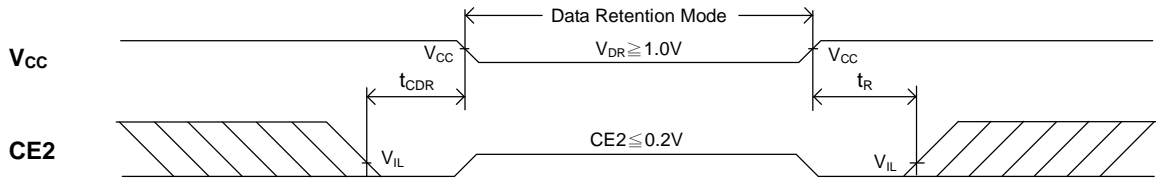

n AC TEST CONDITIONS (Test Load and Input/Output Reference)

Input Pulse Levels	$V_{CC} / 0V$	
Input Rise and Fall Times	1V/ns	
Input and Output Timing Reference Level	0.5 V_{CC}	
Output Load	$t_{CLZ1}, t_{CLZ2}, t_{BE}, t_{OLZ}, t_{CHZ1}, t_{CHZ2}, t_{BDO}, t_{OHZ}, t_{WHZ}, t_{OW}$	$C_L = 5pF+1TTL$
	Others	$C_L = 30pF+1TTL$

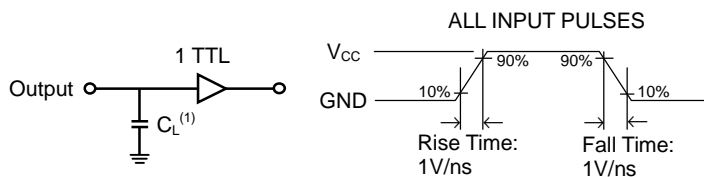

- Including jig and scope capacitance.

n KEY TO SWITCHING WAVEFORMS

WAVEFORM	INPUTS	OUTPUTS
	MUST BE STEADY	MUST BE STEADY
	MAY CHANGE FROM "H" TO "L"	WILL BE CHANGE FROM "H" TO "L"
	MAY CHANGE FROM "L" TO "H"	WILL BE CHANGE FROM "L" TO "H"
	DON'T CARE ANY CHANGE PERMITTED	CHANGE : STATE UNKNOWN
	DOES NOT APPLY	CENTER LINE IS HIGH IMPEDANCE "OFF" STATE

n AC ELECTRICAL CHARACTERISTICS ($T_A = -25^{\circ}\text{C}$ to $+85^{\circ}\text{C}$)
READ CYCLE

JEDEC PARAMETER NAME	PARAMETER NAME	DESCRIPTION	CYCLE TIME : 70ns			UNITS
			MIN.	TYP.	MAX.	
t_{AVAX}	t_{RC}	Read Cycle Time	70	--	--	ns
t_{AVQX}	t_{AA}	Address Access Time	--	--	70	ns
t_{E1LQV}	t_{ACS1}	Chip Select Access Time ($\overline{CE1}$)	--	--	70	ns
t_{E2LQV}	t_{ACS2}	Chip Select Access Time ($CE2$)	--	--	70	ns
t_{BLQV}	t_{BA}	Data Byte Control Access Time (\overline{LB} , \overline{UB})	--	--	70	ns
t_{GLQV}	t_{OE}	Output Enable to Output Valid	--	--	30	ns
t_{E1LQX}	t_{CLZ1}	Chip Select to Output Low Z ($\overline{CE1}$)	10	--	--	ns
t_{E2LQX}	t_{CLZ2}	Chip Select to Output Low Z ($CE2$)	10	--	--	ns
t_{BLQX}	t_{BE}	Data Byte Control to Output Low Z (\overline{LB} , \overline{UB})	10	--	--	ns
t_{GLQX}	t_{OLZ}	Output Enable to Output Low Z	5	--	--	ns
t_{E1HQZ}	t_{CHZ1}	Chip Select to Output High Z ($\overline{CE1}$)	--	--	25	ns
t_{E2HQZ}	t_{CHZ2}	Chip Select to Output High Z ($CE2$)	--	--	25	ns
t_{BHQZ}	t_{BDO}	Data Byte Control to Output High Z (\overline{LB} , \overline{UB})	--	--	25	ns
t_{GHQZ}	t_{OHZ}	Output Enable to Output High Z	--	--	25	ns
t_{AVQX}	t_{OH}	Data Hold from Address Change	10	--	--	ns

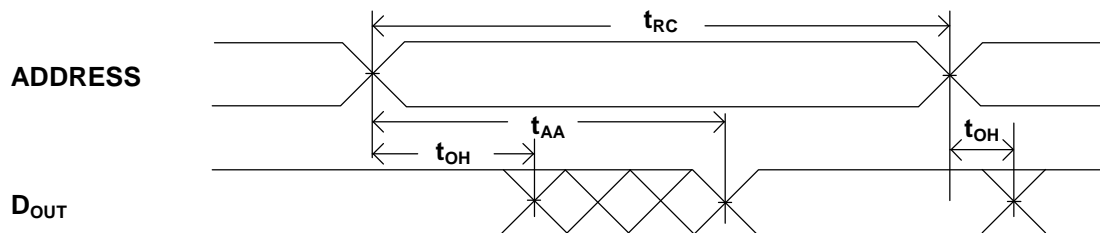
n SWITCHING WAVEFORMS (READ CYCLE)
READ CYCLE 1^(1,2,4)

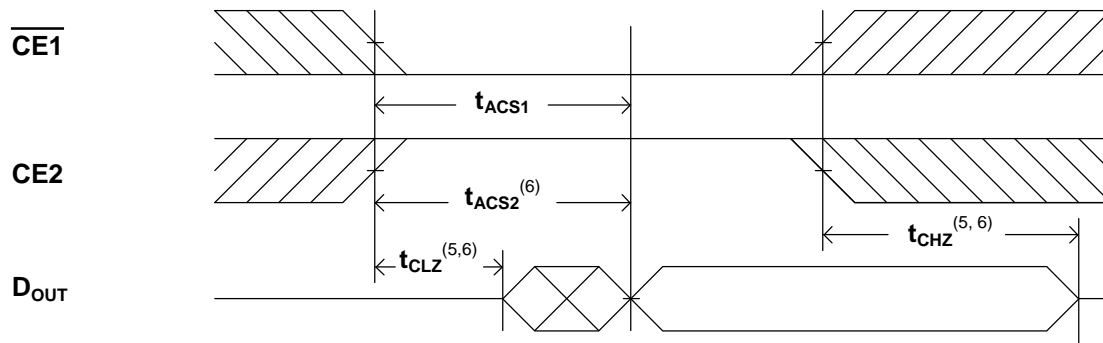
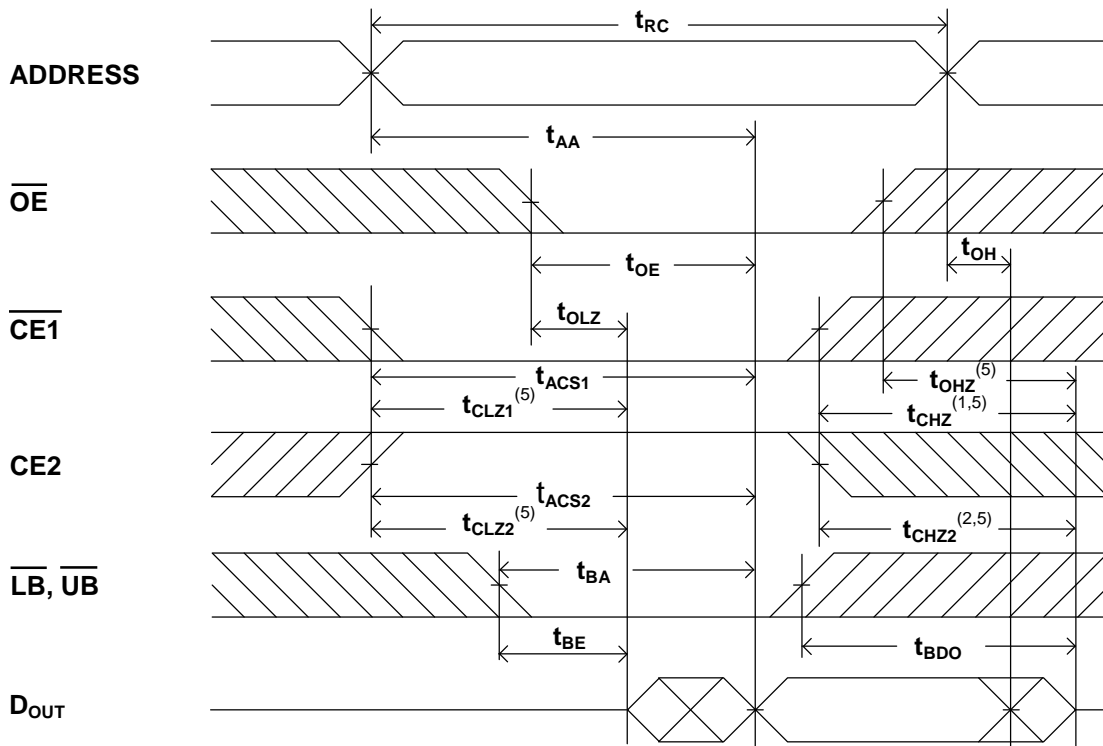
READ CYCLE 2 ^(1,3,4)

READ CYCLE 3 ^(1,4)

NOTES:

1. WE is high in read Cycle.
2. Device is continuously selected when $\overline{CE1} = V_{IL}$ and $CE2 = V_{IH}$.
3. Address valid prior to or coincident with $\overline{CE1}$ transition low and/or $CE2$ transition high.
4. $OE = V_{IL}$.
5. Transition is measured $\pm 500mV$ from steady state with $C_L = 5pF$.
The parameter is guaranteed but not 100% tested.

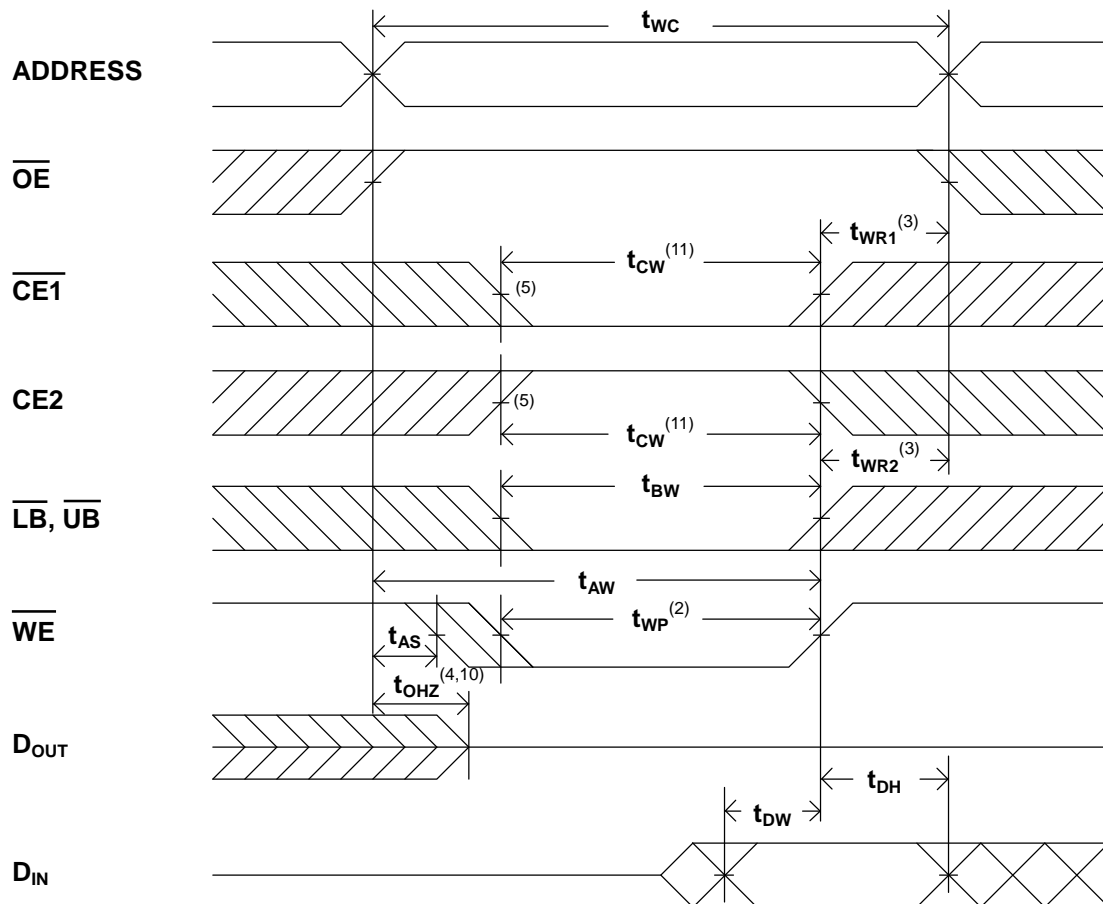
n AC ELECTRICAL CHARACTERISTICS ($T_A = -25^{\circ}\text{C}$ to $+85^{\circ}\text{C}$)
WRITE CYCLE

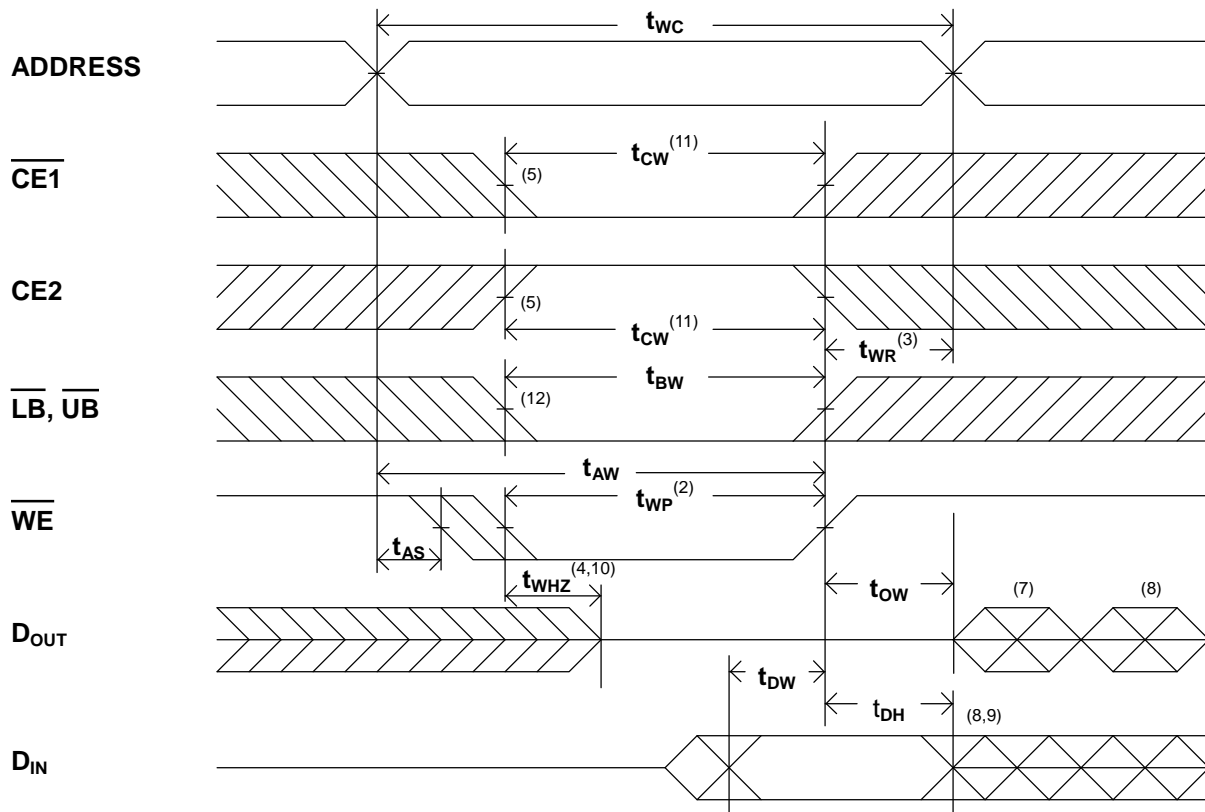
JEDEC PARAMETER NAME	PARAMETER NAME	DESCRIPTION	CYCLE TIME : 70ns			UNITS
			MIN.	TYP.	MAX.	
t_{AVAX}	t_{WC}	Write Cycle Time	70	--	--	ns
t_{AVWL}	t_{AS}	Address Set up Time	0	--	--	ns
t_{AVWH}	t_{AW}	Address Valid to End of Write	50	--	--	ns
t_{ELWH}	t_{CW}	Chip Select to End of Write	50	--	--	ns
t_{BLWH}	t_{BW}	Data Byte Control to End of Write (\overline{LB} , \overline{UB})	50	--	--	ns
t_{WLWH}	t_{WP}	Write Pulse Width	35	--	--	ns
t_{WHAX}	t_{WR1}	Write Recovery Time ($\overline{CE1}$, \overline{WE})	0	--	--	ns
t_{E2LAX}	t_{WR2}	Write Recovery Time ($\overline{CE2}$)	0	--	--	ns
t_{WLQZ}	t_{WHZ}	Write to Output High Z	--	--	20	ns
t_{DVWH}	t_{DW}	Data to Write Time Overlap	30	--	--	ns
t_{WHDX}	t_{DH}	Data Hold from Write Time	0	--	--	ns
t_{GHQZ}	t_{OHZ}	Output Disable to Output in High Z	--	--	25	ns
t_{WHQX}	t_{OW}	End of Write to Output Active	5	--	--	ns

n SWITCHING WAVEFORMS (WRITE CYCLE)
WRITE CYCLE 1 ⁽¹⁾

WRITE CYCLE 2 ^(1,6)

NOTES:

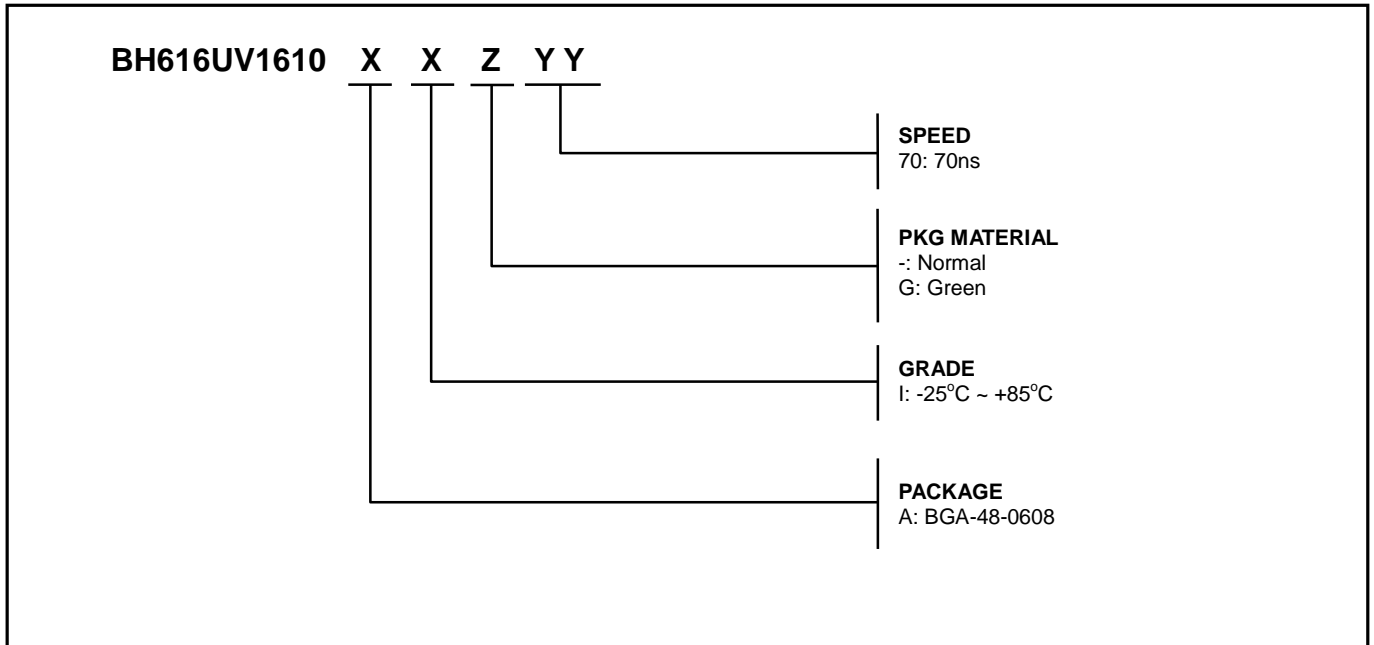
1. \overline{WE} must be high during address transitions.
2. The internal write time of the memory is defined by the overlap of $\overline{CE1}$ and $\overline{CE2}$ active and \overline{WE} low. All signals must be active to initiate a write and any one signal can terminate a write by going inactive. The data input setup and hold timing should be referenced to the second transition edge of the signal that terminates the write.
3. t_{WR} is measured from the earlier of $\overline{CE1}$ or \overline{WE} going high or $\overline{CE2}$ going low at the end of write cycle.
4. During this period, DQ pins are in the output state so that the input signals of opposite phase to the outputs must not be applied.
5. If the $\overline{CE1}$ low transition or the $\overline{CE2}$ high transition occurs simultaneously with the \overline{WE} low transitions or after the \overline{WE} transition, output remain in a high impedance state.
6. OE is continuously low ($OE = V_{IL}$).
7. D_{OUT} is the same phase of write data of this write cycle.
8. D_{OUT} is the read data of next address.
9. If $\overline{CE1}$ is low and $\overline{CE2}$ is high during this period, DQ pins are in the output state. Then the data input signals of opposite phase to the outputs must not be applied to them.
10. Transition is measured $\pm 500\text{mV}$ from steady state with $C_L = 5\text{pF}$.
The parameter is guaranteed but not 100% tested.
11. t_{CW} is measured from the later of $\overline{CE1}$ going low or $\overline{CE2}$ going high to the end of write.

n ORDERING INFORMATION

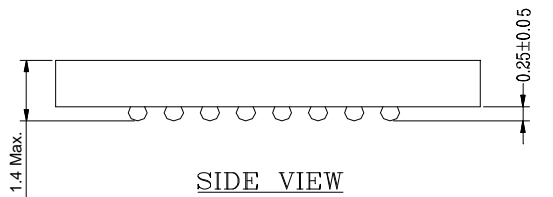
Note:

Brilliance Semiconductor Inc. (BSI) assumes no responsibility for the application or use of any product or circuit described herein. BSI does not authorize its products for use as critical components in any application in which the failure of the BSI product may be expected to result in significant injury or death, including life-support systems and critical medical instruments.

n PACKAGE DIMENSIONS

NOTES:

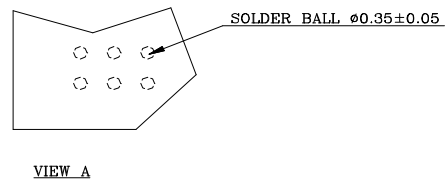
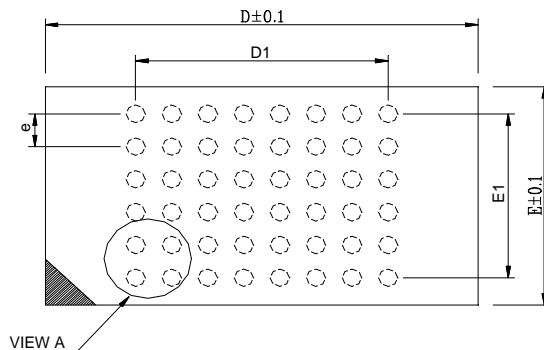
- 1: CONTROLLING DIMENSIONS ARE IN MILLIMETERS.
- 2: PIN#1 DOT MARKING BY LASER OR PAD PRINT.
- 3: SYMBOL "N" IS THE NUMBER OF SOLDER BALLS.

BALL PITCH $e = 0.75$				
D	E	N	D1	E1
8.0	6.0	48	5.25	3.75



48 mini-BGA (6 x 8)

n Revision History

<u>Revision No.</u>	<u>History</u>	<u>Draft Date</u>	<u>Remark</u>
1.0	Initial Production Version	July 15,2005	Initial