

**HIGH SPEED, EXTREMELY LOW NOISE LDO REGULATOR****AP2122****General Description**

The AP2122 series are positive voltage regulator ICs fabricated by CMOS process. Each of these ICs consists of a voltage reference, an error amplifier, a resistor network for setting output voltage, a current limit circuit for current protection and a chip enable circuit .

The AP2122 series feature high ripple rejection, low dropout voltage, low noise, high output voltage accuracy, and low current consumption which make them ideal for use in various battery-powered devices.

The AP2122 series have 1.5V, 1.8V, 2.5V, 2.8V, 3.0V, 3.2V and 3.3V versions.

The AP2122 are available in standard SOT-23-5 package.

Features

- Low Dropout Voltage at $I_{OUT}=100mA$: 150mV Typical (Except 1.5V Version)
- Low Standby Current: 0.1 μA Typical
- Low Quiescent Current: 25 μA Typical
- High Ripple Rejection: 70dB Typical ($f=10kHz$)
- Maximum Output Current: More Than 150mA (300mA Limit)
- Extremely Low Noise: 30 μV_{rms} (10Hz to 100kHz)
- Excellent Line Regulation: 4mV Typical
- Excellent Load Regulation: 12mV Typical
- High Output Voltage Accuracy: $\pm 2\%$
- Excellent Line and Load Transient Response
- Compatible with Low ESR Ceramic Capacitor (as Low as 1 μF)

Applications

- Mobile Phones, Cordless Phones
- MP3/4
- Portable Electronic Devices
- Cameras, Video Recorders
- Sub-board Power Supplies for Telecom Equipment
- Battery Powered Equipment

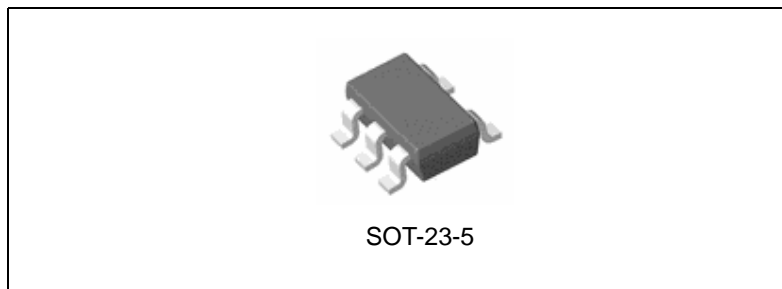

Figure 1. Package Type of AP2122

**HIGH SPEED, EXTREMELY LOW NOISE LDO REGULATOR****AP2122****Pin Configuration**K Package
(SOT-23-5)

Figure 2. Pin Configuration of AP2122 (Top View)

Pin Description

Pin Number	Pin Name	Function
1	V_{OUT}	Regulated output voltage
2	GND	Ground
3	V_{IN}	Input voltage
4	CE	Active high enable input pin. Logic high=enable, logic low=shutdown
5	NC	No connection

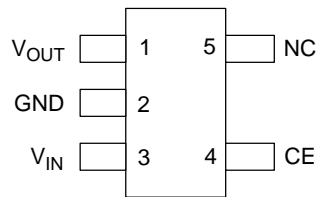

HIGH SPEED, EXTREMELY LOW NOISE LDO REGULATOR

AP2122

Functional Block Diagram

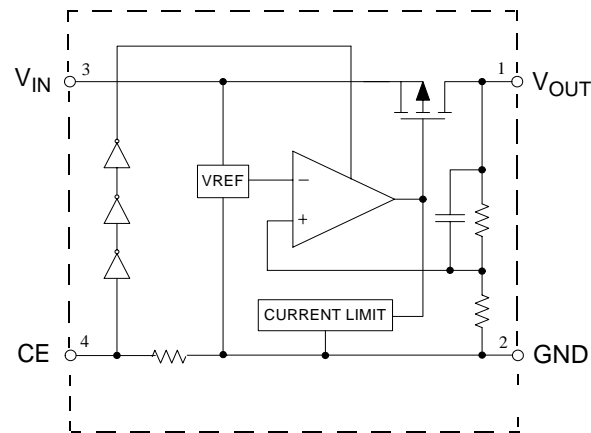
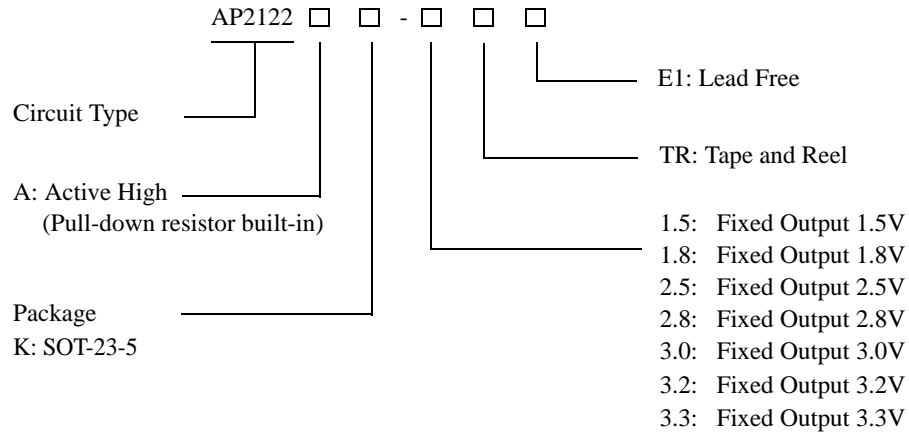

Figure 3. Functional Block Diagram of AP2122



HIGH SPEED, EXTREMELY LOW NOISE LDO REGULATOR AP2122

Ordering Information



Package	Temperature Range	Condition	Part Number	Marking ID	Packing Type
SOT-23-5	-40 to 85°C	Active High (Pull-down resistor built-in)	AP2122AK-1.5TRE1	E2Z	Tape & Reel
		Active High (Pull-down resistor built-in)	AP2122AK-1.8TRE1	E2U	Tape & Reel
		Active High (Pull-down resistor built-in)	AP2122AK-2.5TRE1	E2V	Tape & Reel
		Active High (Pull-down resistor built-in)	AP2122AK-2.8TRE1	E2W	Tape & Reel
		Active High (Pull-down resistor built-in)	AP2122AK-3.0TRE1	E2X	Tape & Reel
		Active High (Pull-down resistor built-in)	AP2122AK-3.2TRE1	E3Y	Tape & Reel
		Active High (Pull-down resistor built-in)	AP2122AK-3.3TRE1	E2Y	Tape & Reel

BCD Semiconductor's Pb-free products, as designated with "E1" suffix in the part number, are RoHS compliant.

**HIGH SPEED, EXTREMELY LOW NOISE LDO REGULATOR****AP2122****Absolute Maximum Ratings (Note 1)**

Parameter	Symbol	Value	Unit
Input Voltage	V_{IN}	6.5	V
Enable Input Voltage	V_{CE}	-0.3 to $V_{IN}+0.3$	V
Output Current	I_{OUT}	300	mA
Junction Temperature	T_J	150	°C
Storage Temperature Range	T_{STG}	-65 to 150	°C
Lead Temperature (Soldering, 10sec)	T_{LEAD}	260	°C
Thermal Resistance (Note 2)	θ_{JA}	250	°C/W
ESD (Human Body Model)	ESD	2000	V
ESD (Machine Model)	ESD	200	V

Note 1: Stresses greater than those listed under "Absolute Maximum Ratings" may cause permanent damage to the device. These are stress ratings only, and functional operation of the device at these or any other conditions beyond those indicated under "Recommended Operating Conditions" is not implied. Exposure to "Absolute Maximum Ratings" for extended periods may affect device reliability.

Note 2: Absolute maximum ratings indicate limits beyond which damage to the component may occur. Electrical specifications do not apply when operating the device outside of its operating ratings. The maximum allowable power dissipation is a function of the maximum junction temperature, $T_{J(max)}$, the junction-to-ambient thermal resistance, θ_{JA} , and the ambient temperature, T_A . The maximum allowable power dissipation at any ambient temperature is calculated using: $P_{D(max)} = (T_{J(max)} - T_A) / \theta_{JA}$. Exceeding the maximum allowable power dissipation will result in excessive die temperature.

Recommended Operating Conditions

Parameter	Symbol	Min	Max	Unit
Input Voltage	V_{IN}	2	6	V
Operating Junction Temperature Range	T_J	-40	85	°C



HIGH SPEED, EXTREMELY LOW NOISE LDO REGULATOR

AP2122

Electrical Characteristics

AP2122-1.5 Electrical Characteristics

($V_{IN}=2.5V$, $T_J=25^{\circ}C$, $C_{IN}=1\mu F$, $C_{OUT}=1\mu F$, **Bold** typeface applies over $-40^{\circ}C \leq T_J \leq 85^{\circ}C$, unless otherwise specified.)

Parameter	Symbol	Conditions	Min	Typ	Max	Unit
Output Voltage	V_{OUT}	$V_{IN}=2.5V$ $1mA \leq I_{OUT} \leq 30mA$	1.47	1.5	1.53	V
Input Voltage	V_{IN}				6	V
Output Current	I_{OUT}	$V_{IN}-V_{OUT}=1V$	150			mA
Load Regulation	V_{RLOAD}	$V_{IN}=2.5V$ $1mA \leq I_{OUT} \leq 80mA$		12	40	mV
Line Regulation	V_{RLINE}	$2.3V \leq V_{IN} \leq 6V$ $I_{OUT}=30mA$		4	16	mV
Dropout Voltage	V_{DROP}	$I_{OUT}=10mA$		400	600	mV
		$I_{OUT}=100mA$		400	600	
		$I_{OUT}=150mA$		400	600	
Quiescent Current	I_Q	$V_{IN}=2.5V$, $I_{OUT}=0mA$		25	50	μA
Standby Current	I_{STD}	$V_{IN}=2.5V$ V_{CE} in OFF mode		0.1	1	μA
Power Supply Rejection Ratio	PSRR	Ripple 0.5Vp-p, $f=10kHz$ $V_{IN}=2.5V$		70		dB
Output Voltage Temperature Coefficient	$\Delta V_{OUT}/\Delta T$	$I_{OUT}=30mA$		± 150		$\mu V/^{\circ}C$
	$(\Delta V_{OUT}/V_{OUT})/\Delta T$			± 100		ppm/ $^{\circ}C$
Short Current Limit	I_{LIMIT}	$V_{OUT}=0V$		50		mA
RMS Output Noise	V_{NOISE}	$T_A=25^{\circ}C$ $10Hz \leq f \leq 100kHz$		30		μV_{rms}
CE "High" Voltage		CE input voltage "High"	1.5			V
CE "Low" Voltage		CE input voltage "Low"			0.25	V
CE Pull-down Internal Resistance	R_{PD}		2.5	5	10	$M\Omega$



HIGH SPEED, EXTREMELY LOW NOISE LDO REGULATOR

AP2122

Electrical Characteristics (Continued)

AP2122-1.8 Electrical Characteristics

($V_{IN}=2.8V$, $T_J=25^{\circ}C$, $C_{IN}=1\mu F$, $C_{OUT}=1\mu F$, **Bold** typeface applies over $-40^{\circ}C \leq T_J \leq 85^{\circ}C$, unless otherwise specified.)

Parameter	Symbol	Conditions	Min	Typ	Max	Unit
Output Voltage	V_{OUT}	$V_{IN}=2.8V$ $1mA \leq I_{OUT} \leq 30mA$	1.764	1.8	1.836	V
Input Voltage	V_{IN}				6	V
Output Current	I_{OUT}	$V_{IN}-V_{OUT}=1V$	150			mA
Load Regulation	V_{RLOAD}	$V_{IN}=2.8V$ $1mA \leq I_{OUT} \leq 80mA$		12	40	mV
Line Regulation	V_{RLINE}	$2.3V \leq V_{IN} \leq 6V$ $I_{OUT}=30mA$		4	16	mV
Dropout Voltage	V_{DROP}	$I_{OUT}=10mA$		20	40	mV
		$I_{OUT}=100mA$		150	300	
		$I_{OUT}=150mA$		200	400	
Quiescent Current	I_Q	$V_{IN}=2.8V$, $I_{OUT}=0mA$		25	50	μA
Standby Current	I_{STD}	$V_{IN}=2.8V$ V_{CE} in OFF mode		0.1	1	μA
Power Supply Rejection Ratio	PSRR	Ripple 0.5Vp-p, $f=10kHz$ $V_{IN}=2.8V$		70		dB
Output Voltage Temperature Coefficient	$\Delta V_{OUT}/\Delta T$	$I_{OUT}=30mA$		± 180		$\mu V/^{\circ}C$
	$(\Delta V_{OUT}/V_{OUT})/\Delta T$			± 100		ppm/ $^{\circ}C$
Short Current Limit	I_{LIMIT}	$V_{OUT}=0V$		50		mA
RMS Output Noise	V_{NOISE}	$T_A=25^{\circ}C$ $10Hz \leq f \leq 100kHz$		30		μV_{rms}
CE "High" Voltage		CE input voltage "High"	1.5			V
CE "Low" Voltage		CE input voltage "Low"			0.25	V
CE Pull-down Internal Resistance	R_{PD}		2.5	5	10	$M\Omega$



HIGH SPEED, EXTREMELY LOW NOISE LDO REGULATOR AP2122

Electrical Characteristics (Continued)

AP2122-2.5 Electrical Characteristics

($V_{IN}=3.5V$, $T_J=25^{\circ}C$, $C_{IN}=1\mu F$, $C_{OUT}=1\mu F$, **Bold** typeface applies over $-40^{\circ}C \leq T_J \leq 85^{\circ}C$, unless otherwise specified.)

Parameter	Symbol	Conditions	Min	Typ	Max	Unit
Output Voltage	V_{OUT}	$V_{IN}=3.5V$ $1mA \leq I_{OUT} \leq 30mA$	2.45	2.5	2.55	V
Input Voltage	V_{IN}				6	V
Output Current	I_{OUT}	$V_{IN}-V_{OUT}=1V$	150			mA
Load Regulation	V_{RLOAD}	$V_{IN}=3.5V$ $1mA \leq I_{OUT} \leq 80mA$		12	40	mV
Line Regulation	V_{RLINE}	$3V \leq V_{IN} \leq 6V$ $I_{OUT}=30mA$		4	16	mV
Dropout Voltage	V_{DROP}	$I_{OUT}=10mA$		20	40	mV
		$I_{OUT}=100mA$		150	300	
		$I_{OUT}=150mA$		200	400	
Quiescent Current	I_Q	$V_{IN}=3.5V$, $I_{OUT}=0mA$		25	50	μA
Standby Current	I_{STD}	$V_{IN}=3.5V$ V_{CE} in OFF mode		0.1	1	μA
Power Supply Rejection Ratio	PSRR	Ripple 0.5Vp-p, $f=10kHz$ $V_{IN}=3.5V$		70		dB
Output Voltage Temperature Coefficient	$\Delta V_{OUT}/\Delta T$ $(\Delta V_{OUT}/V_{OUT})/\Delta T$	$I_{OUT}=30mA$		± 250		$\mu V/^{\circ}C$
				± 100		ppm/ $^{\circ}C$
Short Current Limit	I_{LIMIT}	$V_{OUT}=0V$		50		mA
RMS Output Noise	V_{NOISE}	$T_A=25^{\circ}C$ $10Hz \leq f \leq 100kHz$		30		μV_{rms}
CE "High" Voltage		CE input voltage "High"	1.5			V
CE "Low" Voltage		CE input voltage "Low"			0.25	V
CE Pull-down Internal Resistance	R_{PD}		2.5	5	10	$M\Omega$



HIGH SPEED, EXTREMELY LOW NOISE LDO REGULATOR

AP2122

Electrical Characteristics (Continued)

AP2122-2.8 Electrical Characteristics

($V_{IN}=3.8V$, $T_J=25^{\circ}C$, $C_{IN}=1\mu F$, $C_{OUT}=1\mu F$, **Bold** typeface applies over $-40^{\circ}C \leq T_J \leq 85^{\circ}C$, unless otherwise specified.)

Parameter	Symbol	Conditions	Min	Typ	Max	Unit
Output Voltage	V_{OUT}	$V_{IN}=3.8V$ $1mA \leq I_{OUT} \leq 30mA$	2.744	2.8	2.856	V
Input Voltage	V_{IN}				6	V
Output Current	I_{OUT}	$V_{IN}-V_{OUT}=1V$	150			mA
Load Regulation	V_{RLOAD}	$V_{IN}=3.8V$ $1mA \leq I_{OUT} \leq 80mA$		12	40	mV
Line Regulation	V_{RLINE}	$3.3V \leq V_{IN} \leq 6V$ $I_{OUT}=30mA$		4	16	mV
Dropout Voltage	V_{DROP}	$I_{OUT}=10mA$		20	40	mV
		$I_{OUT}=100mA$		150	300	
		$I_{OUT}=150mA$		200	400	
Quiescent Current	I_Q	$V_{IN}=3.8V$, $I_{OUT}=0mA$		25	50	μA
Standby Current	I_{STD}	$V_{IN}=3.8V$ V_{CE} in OFF mode		0.1	1	μA
Power Supply Rejection Ratio	PSRR	Ripple 0.5Vp-p, $f=10kHz$ $V_{IN}=3.8V$		70		dB
Output Voltage Temperature Coefficient	$\Delta V_{OUT}/\Delta T$	$I_{OUT}=30mA$		± 280		$\mu V/^{\circ}C$
	$(\Delta V_{OUT}/V_{OUT})/\Delta T$			± 100		ppm/ $^{\circ}C$
Short Current Limit	I_{LIMIT}	$V_{OUT}=0V$		50		mA
RMS Output Noise	V_{NOISE}	$T_A=25^{\circ}C$ $10Hz \leq f \leq 100kHz$		30		μV_{rms}
CE "High" Voltage		CE input voltage "High"	1.5			V
CE "Low" Voltage		CE input voltage "Low"			0.25	V
CE Pull-down Internal Resistance	R_{PD}		2.5	5	10	$M\Omega$



HIGH SPEED, EXTREMELY LOW NOISE LDO REGULATOR

AP2122

Electrical Characteristics (Continued)

AP2122-3.0 Electrical Characteristics

($V_{IN}=4V$, $T_J=25^{\circ}C$, $C_{IN}=1\mu F$, $C_{OUT}=1\mu F$, **Bold** typeface applies over $-40^{\circ}C \leq T_J \leq 85^{\circ}C$, unless otherwise specified.)

Parameter	Symbol	Conditions	Min	Typ	Max	Unit
Output Voltage	V_{OUT}	$V_{IN}=4V$ $1mA \leq I_{OUT} \leq 30mA$	2.94	3.0	3.06	V
Input Voltage	V_{IN}				6	V
Output Current	I_{OUT}	$V_{IN}-V_{OUT}=1V$	150			mA
Load Regulation	V_{RLOAD}	$V_{IN}=4V$ $1mA \leq I_{OUT} \leq 80mA$		12	40	mV
Line Regulation	V_{RLINE}	$3.5V \leq V_{IN} \leq 6V$ $I_{OUT}=30mA$		4	16	mV
Dropout Voltage	V_{DROP}	$I_{OUT}=10mA$		20	40	mV
		$I_{OUT}=100mA$		150	300	
		$I_{OUT}=150mA$		200	400	
Quiescent Current	I_Q	$V_{IN}=4V$, $I_{OUT}=0mA$		25	50	μA
Standby Current	I_{STD}	$V_{IN}=4V$ V_{CE} in OFF mode		0.1	1	μA
Power Supply Rejection Ratio	PSRR	Ripple 0.5Vp-p, $f=10kHz$ $V_{IN}=4V$		70		dB
Output Voltage Temperature Coefficient	$\frac{\Delta V_{OUT}}{\Delta T}$ $(\frac{\Delta V_{OUT}}{V_{OUT}})/\Delta T$	$I_{OUT}=30mA$		± 300		$\mu V/^{\circ}C$
				± 100		ppm/ $^{\circ}C$
Short Current Limit	I_{LIMIT}	$V_{OUT}=0V$		50		mA
RMS Output Noise	V_{NOISE}	$T_A=25^{\circ}C$ $10Hz \leq f \leq 100kHz$		30		μV_{rms}
CE "High" Voltage		CE input voltage "High"	1.5			V
CE "Low" Voltage		CE input voltage "Low"			0.25	V
CE Pull-down Internal Resistance	R_{PD}		2.5	5	10	$M\Omega$



HIGH SPEED, EXTREMELY LOW NOISE LDO REGULATOR AP2122

Electrical Characteristics (Continued)

AP2122-3.2 Electrical Characteristics

($V_{IN}=4.2V$, $T_J=25^{\circ}C$, $C_{IN}=1\mu F$, $C_{OUT}=1\mu F$, **Bold** typeface applies over $-40^{\circ}C \leq T_J \leq 85^{\circ}C$, unless otherwise specified.)

Parameter	Symbol	Conditions	Min	Typ	Max	Unit
Output Voltage	V_{OUT}	$V_{IN}=4.2V$ $1mA \leq I_{OUT} \leq 30mA$	3.136	3.2	3.264	V
Input Voltage	V_{IN}				6	V
Output Current	I_{OUT}	$V_{IN}-V_{OUT}=1V$	150			mA
Load Regulation	V_{RLOAD}	$V_{IN}=4.2V$ $1mA \leq I_{OUT} \leq 80mA$		12	40	mV
Line Regulation	V_{RLINE}	$3.7V \leq V_{IN} \leq 6V$ $I_{OUT}=30mA$		4	16	mV
Dropout Voltage	V_{DROP}	$I_{OUT}=10mA$		20	40	mV
		$I_{OUT}=100mA$		150	300	
		$I_{OUT}=150mA$		200	400	
Quiescent Current	I_Q	$V_{IN}=4.2V$, $I_{OUT}=0mA$		25	50	μA
Standby Current	I_{STD}	$V_{IN}=4.2V$ V_{CE} in OFF mode		0.1	1	μA
Power Supply Rejection Ratio	PSRR	Ripple 0.5Vp-p, $f=10kHz$ $V_{IN}=4.2V$		70		dB
Output Voltage Temperature Coefficient	$\Delta V_{OUT}/\Delta T$	$I_{OUT}=30mA$		± 320		$\mu V/^{\circ}C$
	$(\Delta V_{OUT}/V_{OUT})/\Delta T$			± 100		ppm/ $^{\circ}C$
Short Current Limit	I_{LIMIT}	$V_{OUT}=0V$		50		mA
RMS Output Noise	V_{NOISE}	$T_A=25^{\circ}C$ $10Hz \leq f \leq 100kHz$		30		μV_{rms}
CE "High" Voltage		CE input voltage "High"	1.5			V
CE "Low" Voltage		CE input voltage "Low"			0.25	V
CE Pull-down Internal Resistance	R_{PD}		2.5	5	10	$M\Omega$



HIGH SPEED, EXTREMELY LOW NOISE LDO REGULATOR

AP2122

Electrical Characteristics (Continued)

AP2122-3.3 Electrical Characteristics

($V_{IN}=4.3V$, $T_J=25^{\circ}C$, $C_{IN}=1\mu F$, $C_{OUT}=1\mu F$, **Bold** typeface applies over $-40^{\circ}C \leq T_J \leq 85^{\circ}C$, unless otherwise specified.)

Parameter	Symbol	Conditions	Min	Typ	Max	Unit
Output Voltage	V_{OUT}	$V_{IN}=4.3V$ $1mA \leq I_{OUT} \leq 30mA$	3.234	3.3	3.366	V
Input Voltage	V_{IN}				6	V
Output Current	I_{OUT}	$V_{IN}-V_{OUT}=1V$	150			mA
Load Regulation	V_{RLOAD}	$V_{IN}=4.3V$ $1mA \leq I_{OUT} \leq 80mA$		12	40	mV
Line Regulation	V_{RLINE}	$3.8V \leq V_{IN} \leq 6V$ $I_{OUT}=30mA$		4	16	mV
Dropout Voltage	V_{DROP}	$I_{OUT}=10mA$		20	40	mV
		$I_{OUT}=100mA$		150	300	
		$I_{OUT}=150mA$		200	400	
Quiescent Current	I_Q	$V_{IN}=4.3V$, $I_{OUT}=0mA$		25	50	μA
Standby Current	I_{STD}	$V_{IN}=4.3V$ V_{CE} in OFF mode		0.1	1	μA
Power Supply Rejection Ratio	PSRR	Ripple 0.5Vp-p, $f=10kHz$ $V_{IN}=4.3V$		70		dB
Output Voltage Temperature Coefficient	$\Delta V_{OUT}/\Delta T$	$I_{OUT}=30mA$		± 330		$\mu V/^{\circ}C$
	$(\Delta V_{OUT}/V_{OUT})/\Delta T$			± 100		ppm/ $^{\circ}C$
Short Current Limit	I_{LIMIT}	$V_{OUT}=0V$		50		mA
RMS Output Noise	V_{NOISE}	$T_A=25^{\circ}C$ $10Hz \leq f \leq 100kHz$		30		μV_{rms}
CE "High" Voltage		CE input voltage "High"	1.5			V
CE "Low" Voltage		CE input voltage "Low"			0.25	V
CE Pull-down Internal Resistance	R_{PD}		2.5	5	10	$M\Omega$



HIGH SPEED, EXTREMELY LOW NOISE LDO REGULATOR

AP2122

Typical Performance Characteristics

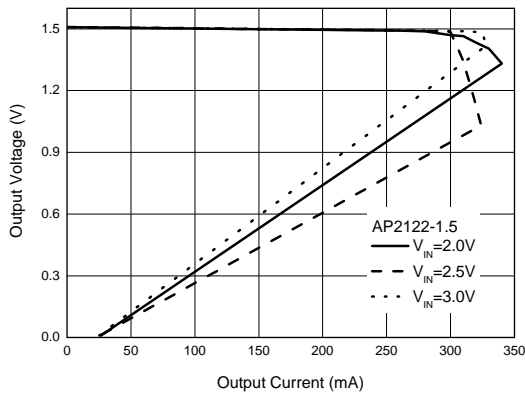

Figure 4. Output Voltage vs. Output Current

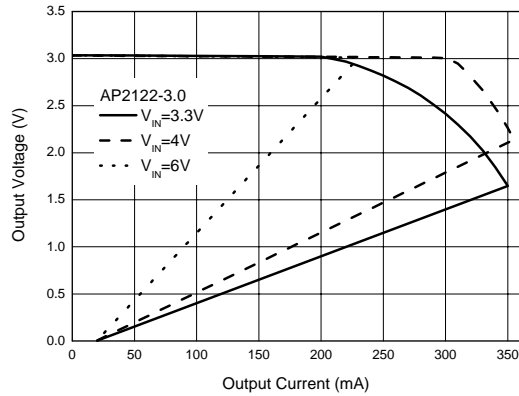

Figure 5. Output Voltage vs. Output Current

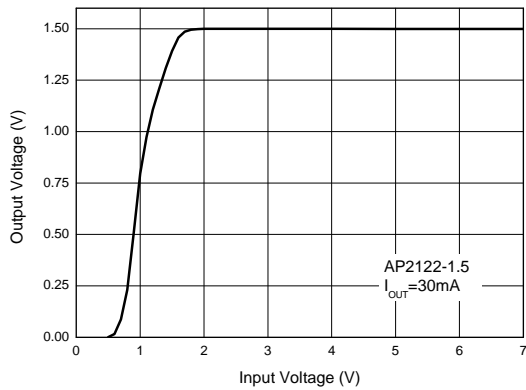

Figure 6. Output Voltage vs. Input Voltage

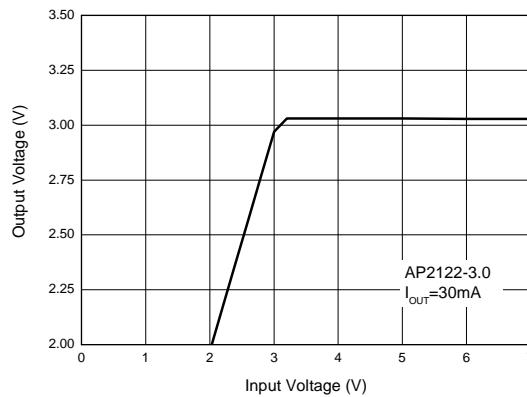

Figure 7. Output Voltage vs. Input Voltage



HIGH SPEED, EXTREMELY LOW NOISE LDO REGULATOR

AP2122

Typical Performance Characteristics (Continued)

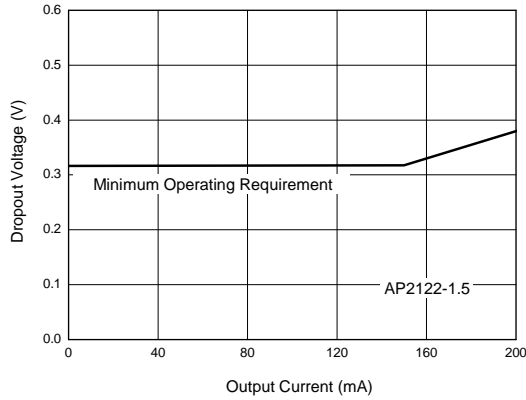

Figure 8. Dropout Voltage vs. Output Current

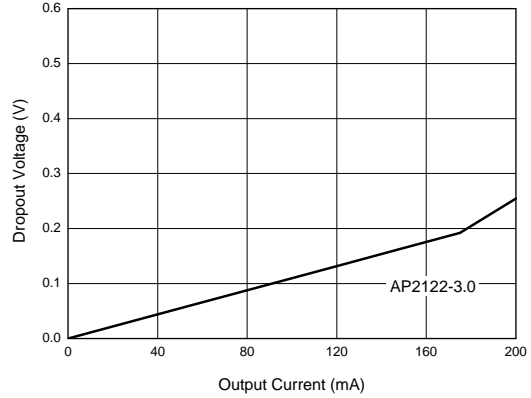

Figure 9. Dropout Voltage vs. Output Current

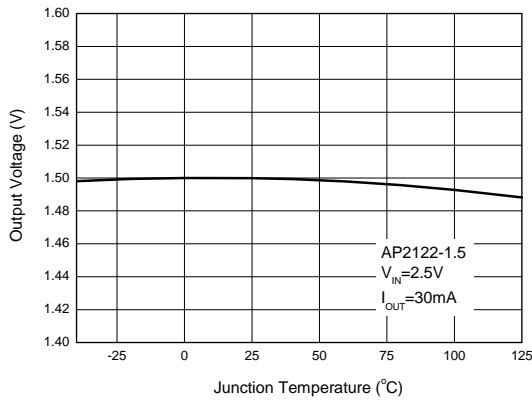

Figure 10. Output Voltage vs. Junction Temperature

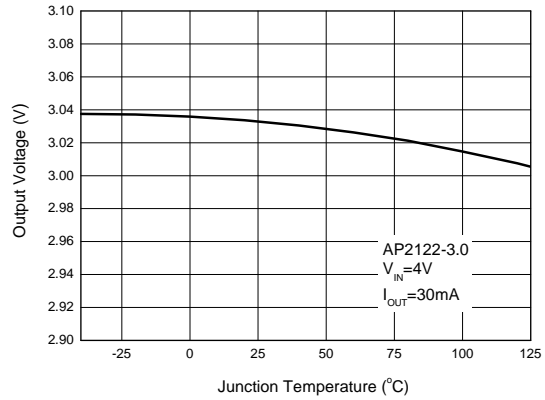

Figure 11. Output Voltage vs. Junction Temperature



HIGH SPEED, EXTREMELY LOW NOISE LDO REGULATOR

AP2122

Typical Performance Characteristics (Continued)

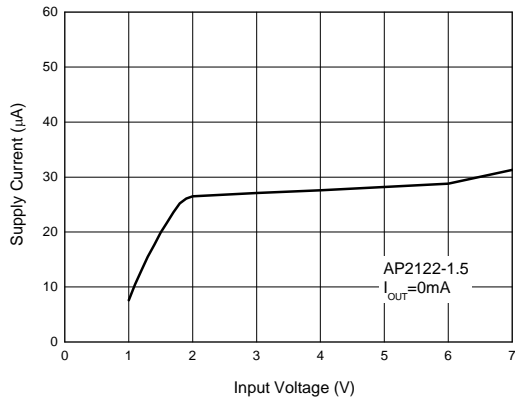

Figure 12. Supply Current vs. Input Voltage

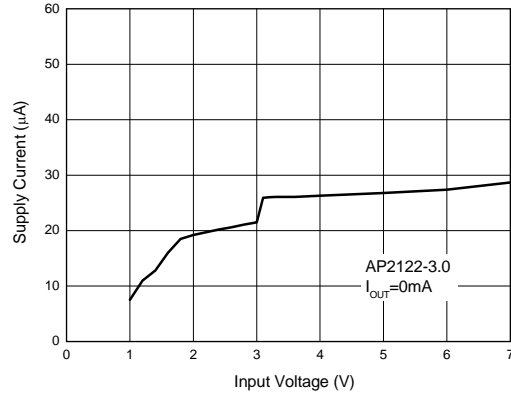

Figure 13. Supply Current vs. Input Voltage

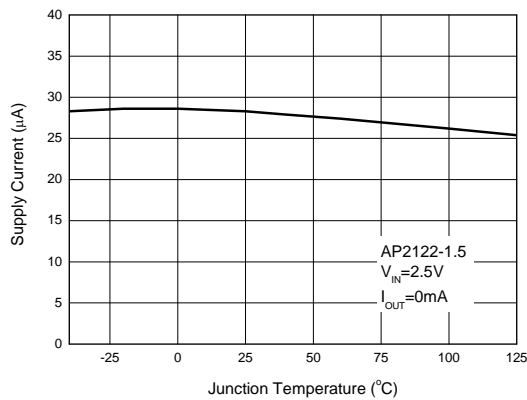

Figure 14. Supply Current vs. Junction Temperature

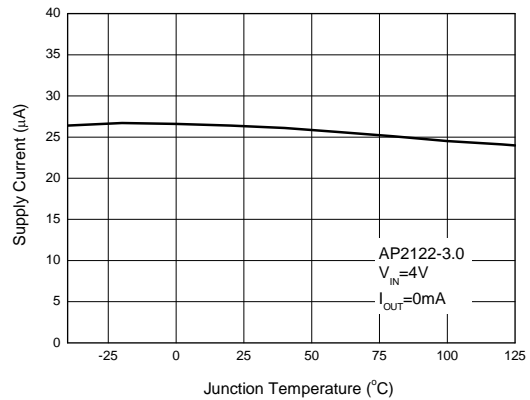

Figure 15. Supply Current vs. Junction Temperature



HIGH SPEED, EXTREMELY LOW NOISE LDO REGULATOR

AP2122

Typical Performance Characteristics (Continued)

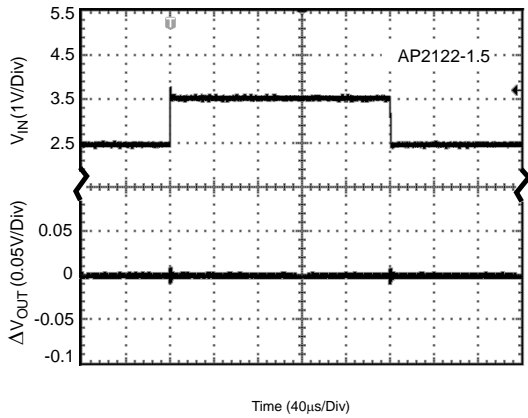

Figure 16. Line Transient
(Conditions: $I_{OUT}=30\text{mA}$, $C_{IN}=1\mu\text{F}$, $C_{OUT}=1\mu\text{F}$)

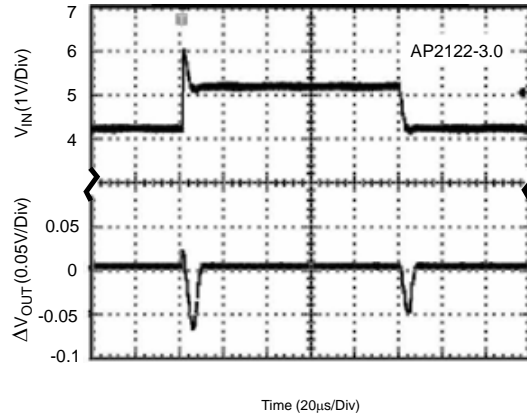

Figure 17. Line Transient
(Conditions: $I_{OUT}=30\text{mA}$, $C_{IN}=1\mu\text{F}$, $C_{OUT}=1\mu\text{F}$)

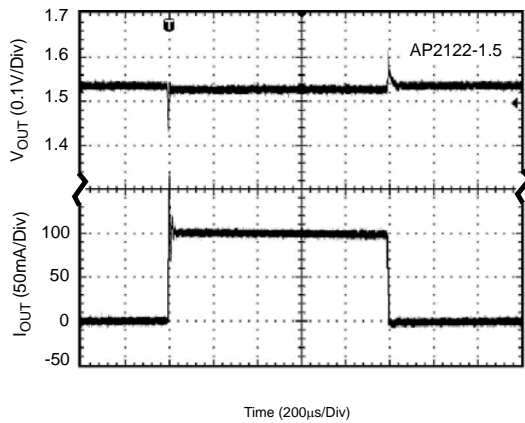

Figure 18. Load Transient
(Conditions: $V_{IN}=2.5\text{V}$, $C_{IN}=1\mu\text{F}$, $C_{OUT}=1\mu\text{F}$)

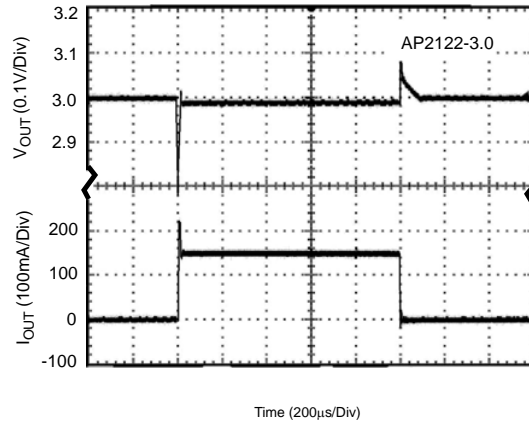

Figure 19. Load Transient
(Conditions: $V_{IN}=4\text{V}$, $C_{IN}=1\mu\text{F}$, $C_{OUT}=1\mu\text{F}$)



HIGH SPEED, EXTREMELY LOW NOISE LDO REGULATOR

AP2122

Typical Performance Characteristics (Continued)

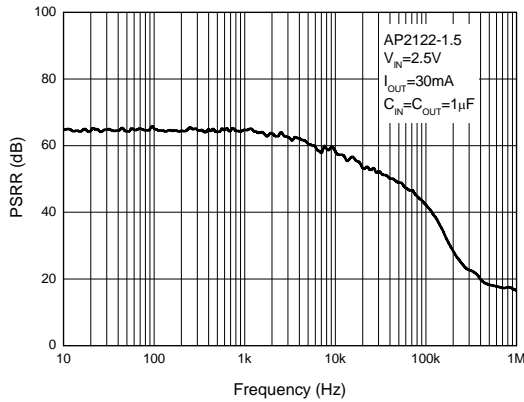

Figure 20. PSRR vs. Frequency

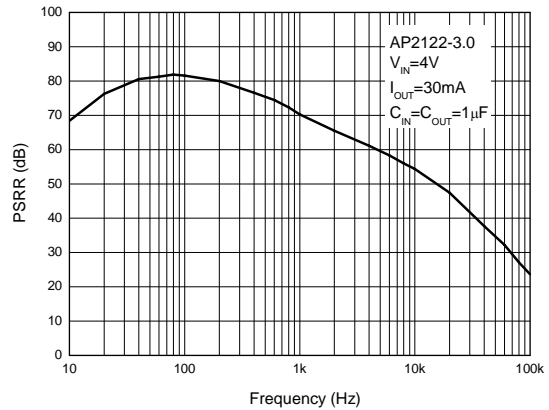
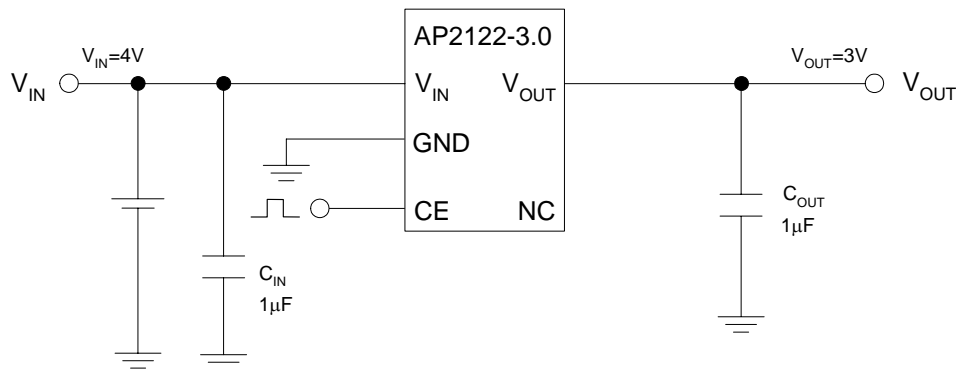

Figure 21. PSRR vs. Frequency

**HIGH SPEED, EXTREMELY LOW NOISE LDO REGULATOR****AP2122****Typical Application**

Note: Filter capacitors are required at the AP2122's input and output. $1\mu F$ capacitor is required at the input. The minimum output capacitance required for stability should be more than $1\mu F$ with ESR from 0.01Ω to 100Ω . Ceramic capacitors are recommended.

Figure 22. Typical Application of AP2122



HIGH SPEED, EXTREMELY LOW NOISE LDO REGULATOR

AP2122

Mechanical Dimensions

SOT-23-5

Unit: mm(inch)

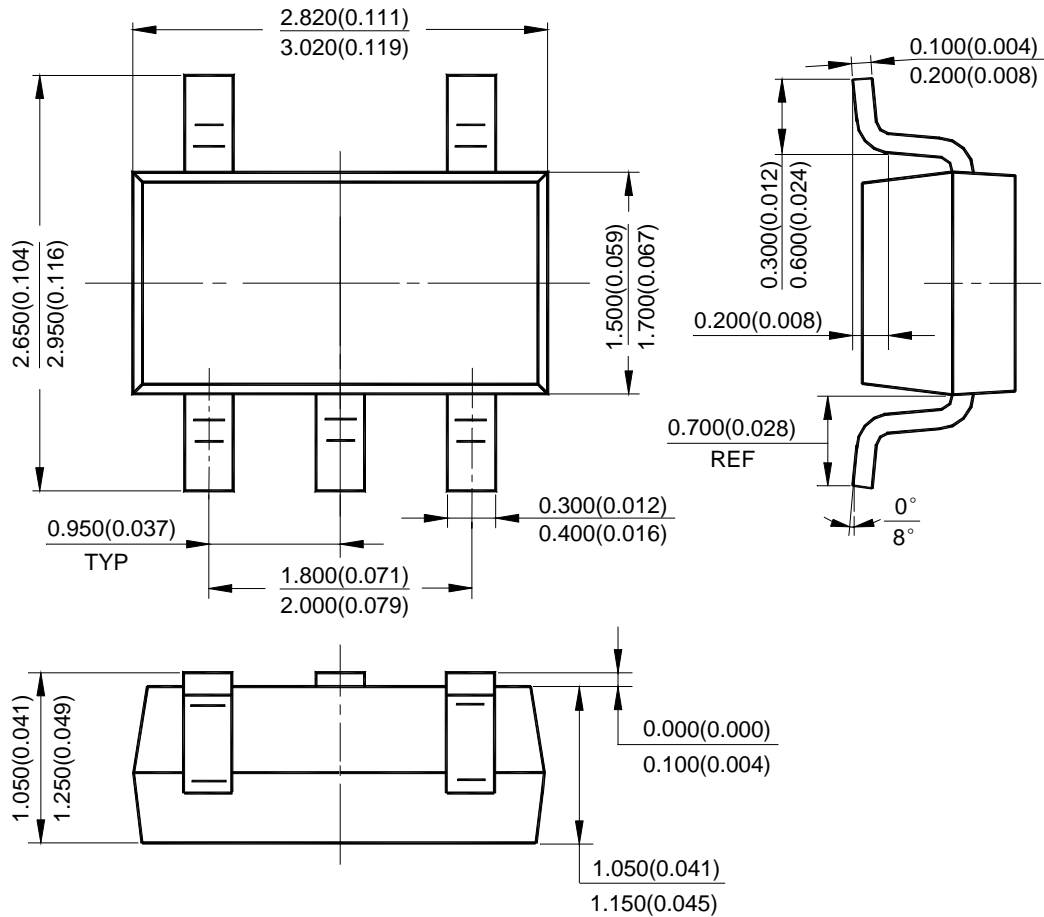



BCD Semiconductor Manufacturing Limited

<http://www.bcdsemi.com>

IMPORTANT NOTICE

BCD Semiconductor Manufacturing Limited reserves the right to make changes without further notice to any products or specifications herein. BCD Semiconductor Manufacturing Limited does not assume any responsibility for use of any its products for any particular purpose, nor does BCD Semiconductor Manufacturing Limited assume any liability arising out of the application or use of any its products or circuits. BCD Semiconductor Manufacturing Limited does not convey any license under its patent rights or other rights nor the rights of others.

MAIN SITE

BCD Semiconductor Manufacturing Limited
- Wafer Fab
Shanghai SIM-BCD Semiconductor Manufacturing Limited
800, Yi Shan Road, Shanghai 200233, China
Tel: +86-21-6485 1491, Fax: +86-21-5450 0008

BCD Semiconductor Manufacturing Limited
- IC Design Group
Advanced Analog Circuits (Shanghai) Corporation
8F, Zone B, 900, Yi Shan Road, Shanghai 200233, China
Tel: +86-21-6495 9539, Fax: +86-21-6485 9673

REGIONAL SALES OFFICE

Shenzhen Office
Shanghai SIM-BCD Semiconductor Manufacturing Co., Ltd. Shenzhen Office
Advanced Analog Circuits (Shanghai) Corporation Shenzhen Office
Room E, 5F, Noble Center, No.1006, 3rd Fuzhong Road, Futian District, Shenzhen 518026, China
Tel: +86-755-8826 7951, Fax: +86-755-8826 7865

Taiwan Office
BCD Semiconductor (Taiwan) Company Limited
4F, 298-1, Rui Guang Road, Nei-Hu District, Taipei,
Taiwan
Tel: +886-2-2656 2808, Fax: +886-2-2656 2806

USA Office
BCD Semiconductor Corporation
3170 De La Cruz Blvd., Suite 105,
Santa Clara,
CA 95054-2411, U.S.A