

FEATURES

- LOW COST 3 PHASE INTELLIGENT SWITCHING AMPLIFIER
- 3 FULLY PROTECTED HALF BRIDGES
- UP TO 60V SUPPLY
- OUTPUT CURRENT - 5 AMPS (CONT) PER HALF BRIDGE
- NO "SHOOT THROUGH" CURRENT

APPLICATIONS

- 3 PHASE BRUSHLESS DC MOTORS
- 3 INDEPENDENT SOLENOID ACTUATORS

DESCRIPTION

The SA305 is an integrated, fully protected, 3 phase brushless DC motor driver IC. Three independent half bridges provide up to 5A of continuous (10A peak) output current under microcontroller or DSP control.

Thermal, short circuit, shootthrough, and over current protection are included in this power device. Fault status indication and current level monitors are provided directly to the controller. The SA305 is built using a multi-technology process allowing CMOS logic control and DMOS output power devices on the same IC. Output current is measured using an innovative low loss technique. The SIP package offers superior thermal performance with a flexible footprint.

BLOCK DIAGRAM

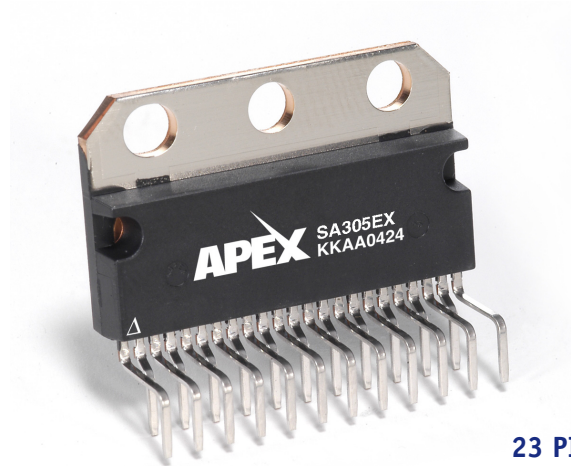
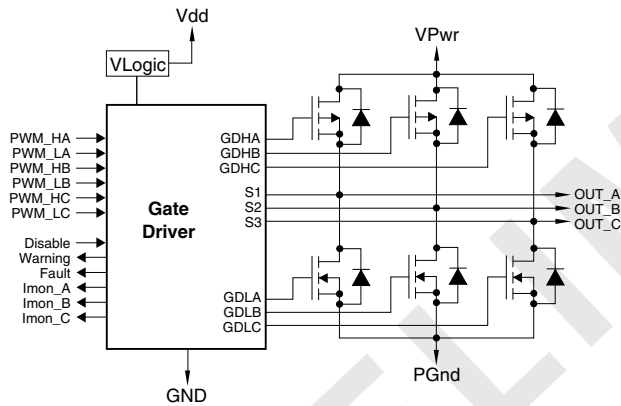

23 PIN SIP PACKAGE STYLE EX

TYPICAL APPLICATION

The SA305 offers a level of power integration unmatched by others in the field of fractional HP brushless motor control.

EXTERNAL CONNECTIONS

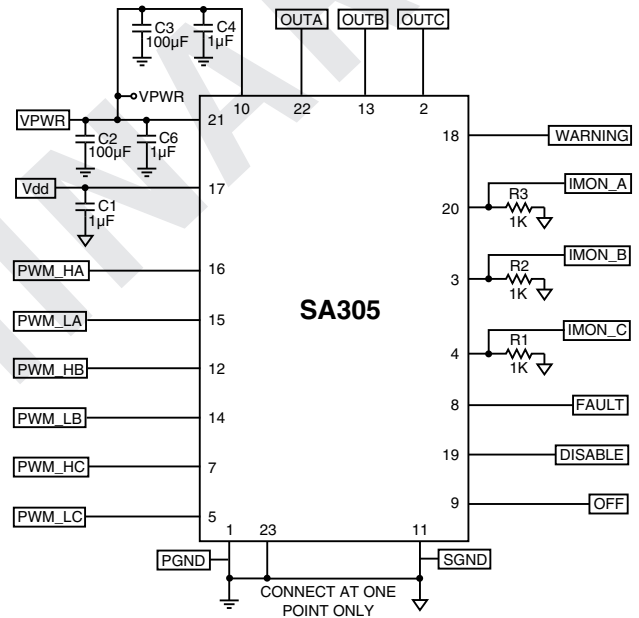

PIN DESCRIPTIONS

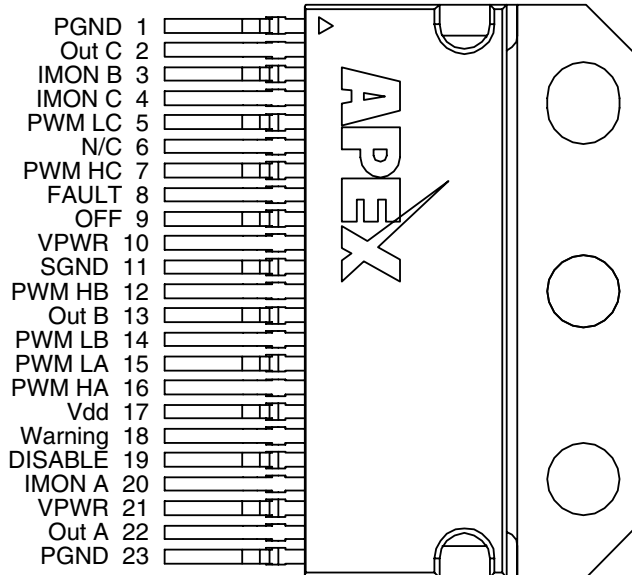

Pin #	Pin name	Description
10,21	Vs/VPWR	High voltage supply (12V-60V)
17	Vdd	Logic supply (5V)
22	OutA	Half bridge output
13	OutB	Half bridge output
2	OutC	Half bridge output
1,23	PGND	Power ground, high current ground return path of the bridge outputs
11	SGND	Analog and logic circuits ground
19	DISABLE	Disable logic Input, CMOS. When high disables all six output MOSFETs independent of the Control registers.
18	Warning	Output pin goes high at $T_j > 135^\circ\text{C}$.
8	FAULT	The Fault output is raised under the following conditions: a) Short-Circuit and Over Current condition. b) High Temperature condition. c) High Voltage Supply $V_s < 12\text{V}$. This can be used as an interrupt to the microcontroller. It will be reset after status data has been read by the microcontroller. A FAULT will also disable the outputs of the device.
16	PWM_HA	goes high in order to indicate the Pchannel of output A is to be turned on.
15	PWM_LA	goes high in order to indicate the Nchannel of output A is to be turned on.
12	PWM_HB	goes high in order to indicate the Pchannel of output B is to be turned on.
14	PWM_LB	goes high in order to indicate the Nchannel of output B is to be turned on.
7	PWM_HC	goes high in order to indicate the Pchannel of output C is to be turned on.
5	PWM_LC	goes high in order to indicate the Nchannel of output C is to be turned on.
20	IMON_A	Current monitor output, approximate current 1/4000 of Phase A current
3	IMON_B	Current monitor output, approximate current 1/3600 of Phase B current
4	IMON_C	Current monitor output, approximate current 1/3700 of Phase C current
9	OFF	Disables all Fault Mechanisms when pulled HIGH

All inputs are CMOS levels. Inputs can accept CMOS levels as low as 3.3 volts

ABSOLUTE MAXIMUM RATINGS

SUPPLY VOLTAGE, +Vs	60V
SUPPLY VOLTAGE, Vcc	5.5V
OUTPUT CURRENT, peak, 200ms	10A
POWER DISSIPATION, internal, DC	TBD
TEMPERATURE, pin solder, 10s	225°C.
TEMPERATURE, junction ²	150°C.
TEMPERATURE RANGE, storage	-55 to 125°C.
OPERATING TEMPERATURE, case	-40 to 85°C.

SPECIFICATIONS

PARAMETER	TEST CONDITIONS	MIN	TYP	MAX	UNITS
INPUTS					
Logic Low Voltage				1	V
Logic High Voltage		1.8			V
POWER SUPPLY					
Vs		12		60	V
Vcc		4.5		5.5	V
Supply Current, Vpwr	10 KHz (One channel switching at 50% duty cycle), VPWR=50V, Vdd=5V		8.5	35	mA
Supply Current, Vdd	10 KHz (One channel switching at 50% duty cycle), VPWR=50V, Vdd=5V		4	6	mA
ANALOG					
Current Sense Linearity	Iout = 1A to 5A		0.6	1.5	%
Current Sense Linearity	Iout = 100mA to 5A			5	%
OUTPUT					
Output Current, continuous				5	A
Output Current, Peak	For 200ms			10	A
Turn on delay, default			183		nS
Turn off delay, default			240		nS
Switching time, on, default			47		nS
Switching time, off, default			52		nS
On resistance, PCHAN FET	5A Load (Room Temperature)		325	600	mΩ
On resistance, NCHAN FET	5A Load (Room Temperature)		250	600	mΩ
Short circuit turn off time			TBD		nS
Thermal Shutdown		155	160		°C
Thermal Warning			135		°C
Overcurrent Shutdown		10	12		A
THERMAL					
RESISTANCE, junction to case	Full temperature range		0.95	TBD	°C/W
RESISTANCE, junction to air	Full temperature range			TBD	°C/W
TEMPERATURE RANGE, case		-40		85	°C

NOTES: 1. Unless otherwise noted: T_c=25°C, power supply voltage is typical rating. (VPWR = 50 V, Vdd = 5V).
2. Long term operation at the maximum junction temperature will result in reduced product life. De-rate internal power dissipation to achieve high MTBF.

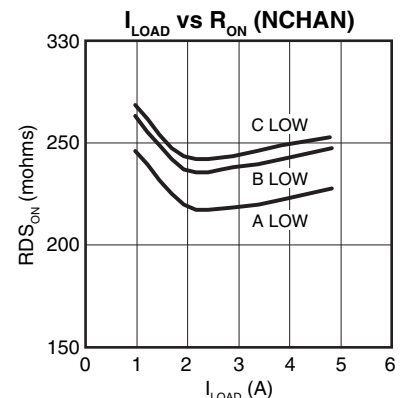
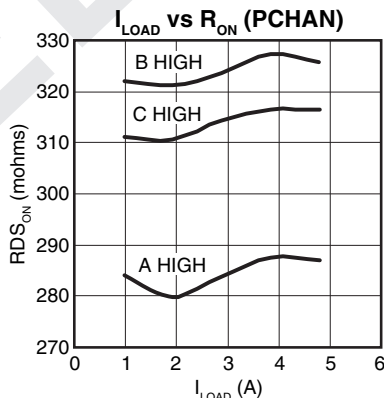
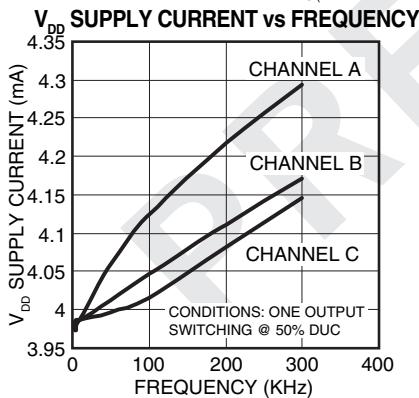
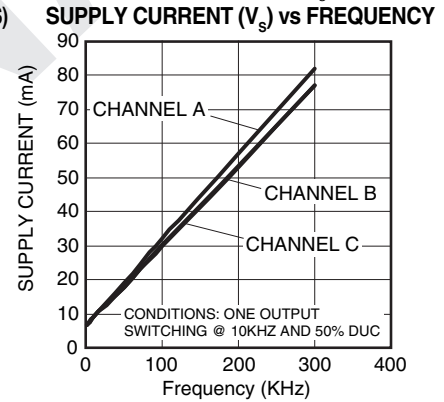
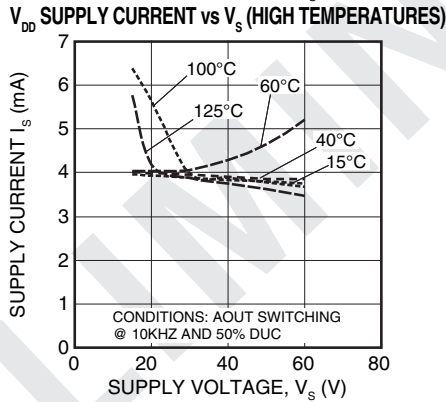
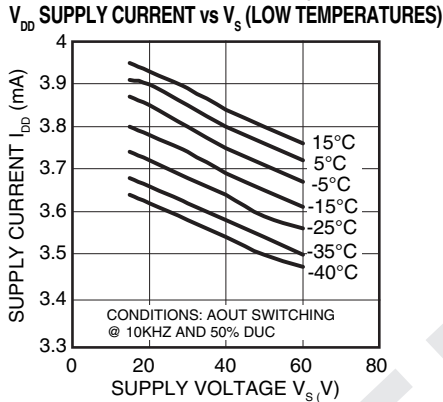
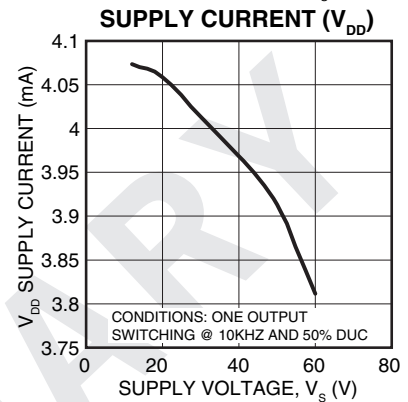
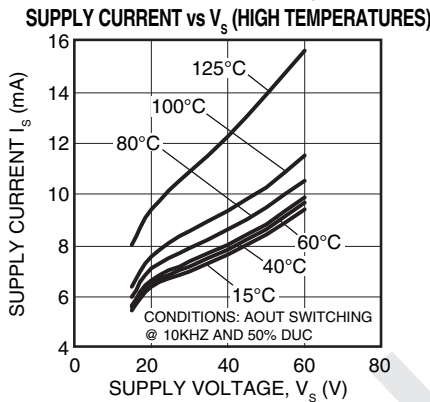
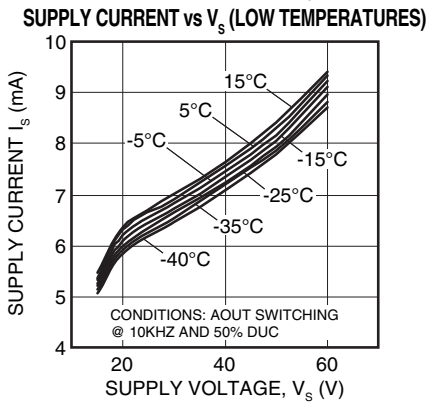
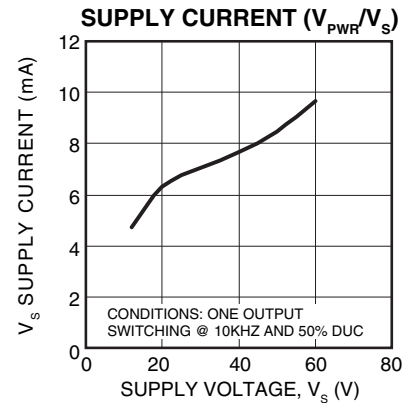
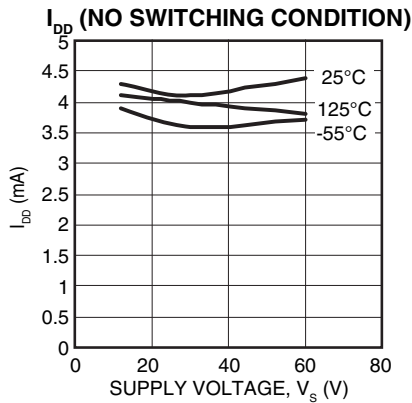
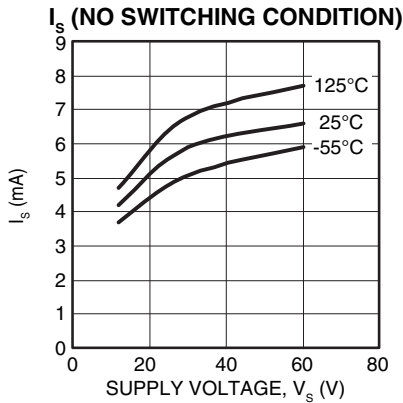

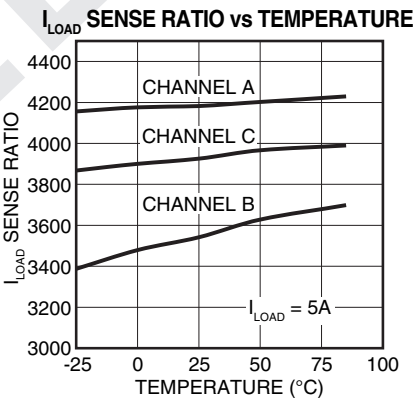
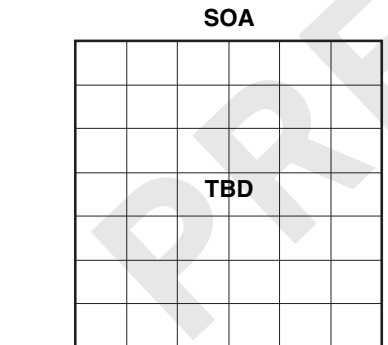
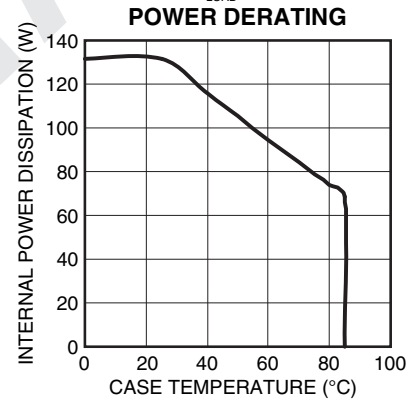
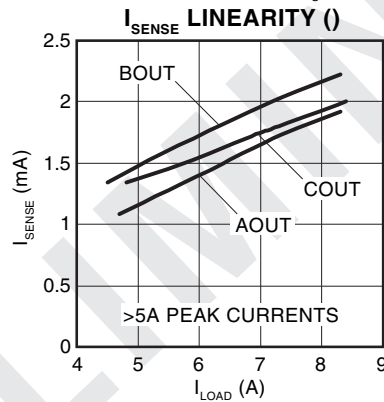
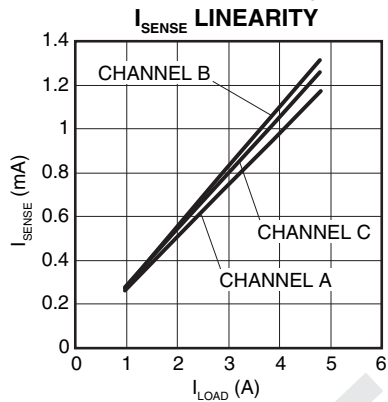
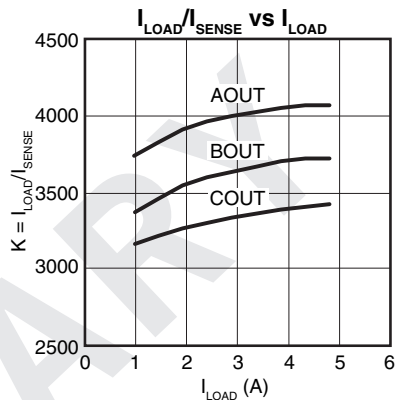
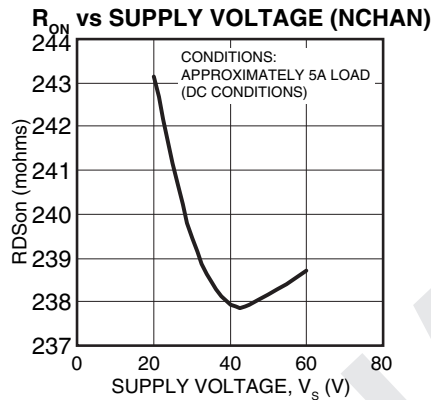
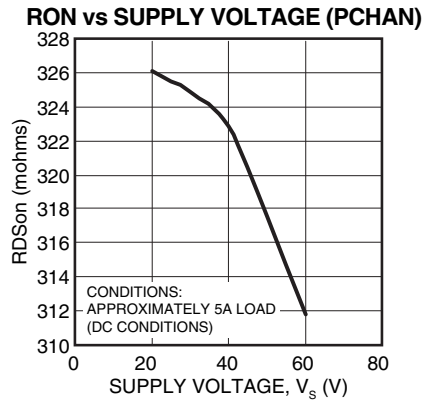
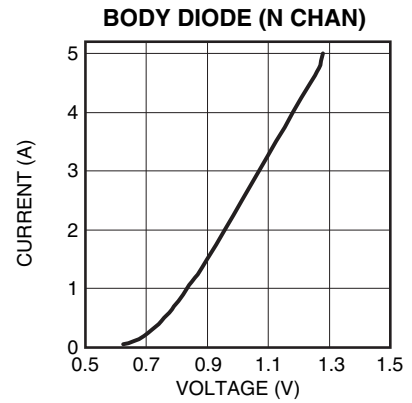
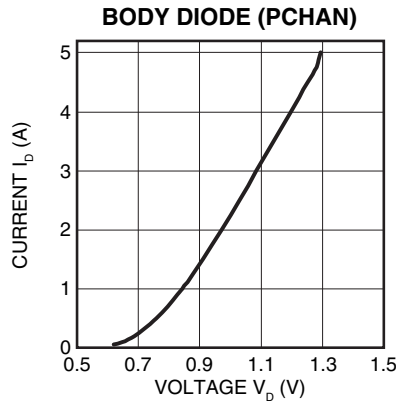
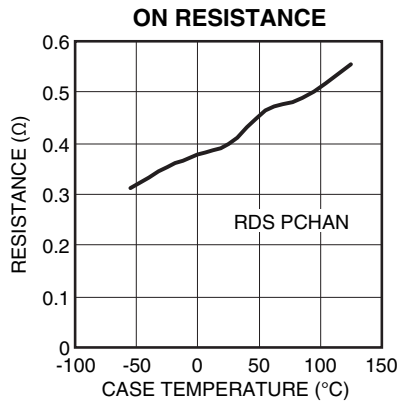

GENERAL

Please read Apex Application Note 1 “General Operating Considerations” which covers stability, power supplies, heat sinking, mounting, current limit, SOA interpretation, and specification interpretation. Visit www.apexmicrotech.com for design tools that help automate tasks such as calculations for stability, internal power dissipation, current limit, heat sink selection, Apex’s complete Application Notes library, Technical Seminar Workbook and Evaluation Kits.

GROUND PINS

Analog and Power Grounds should be connected externally at only one point on the motor control board in such a way that there is no current flow through the connection to avoid noise related issues.

PROTECTION

Each of the six output devices includes short circuit protection to prevent damage from direct shorts to GND or VS. The SA305 is protected against overheating with built in thermal monitoring. The thermal protection will engage when the temperature of the MOSFETs reach approximately 160°C. The FAULT output pin will latch “HIGH” if either protection circuits engages and will place all MOSFETs in the “OFF” state (high impedance output). The most severe condition for any power device is a direct, hard-wired (“screwdriver”) short from an output to ground. While the short circuit protection will latch the output MOSFETs the die and package may be required to dissipate up to 500 Watts of power until the protection is engaged. This energy can be destructive, particularly at higher operating voltages, so good thermal design is critical if such fault tolerance is required of the system. The Vs and PGND pins may become very hot during this period of high current.

The SA305 has an internal FAULT latch mechanism by which the device stays disabled (in case a fault occurs) unless the user resets it. If the SA305 goes into FAULT condition because of short-circuit, over current or high temperature, the DISABLE pin needs to be pulled HIGH (briefly) to reset the SA305 and resume normal operation. However, before resetting the SA305 the user has to ensure that the FAULT has been eliminated.

Undervoltage lockout is not required since the power stage is complimentary and does not need a charge pump to activate the high side FETs. A True signal on the FAULT pin indicates that at least one of these protection events has occurred. Once a FAULT has occurred, fault condition must be removed in order for the FAULT signal to be removed.

CONTROL

Each output device is controlled by a single input. There is a provision inside the SA305 to prevent the upper and lower FET of the same channel from being active at the same time even though the input controls request that both the N and P devices from half bridges be on.

POWER SUPPLY BYPASSING

Bypass capacitors to power supply terminals +Vs and -Vs must be connected physically close to the pins to prevent lo-

cal parasitic oscillation in the output stage of the SA305. Use electrolytic capacitors at least 10 μ F per output amp required. Bypass the electrolytic capacitors with high quality ceramic capacitors (X7R) 0.1 μ F or greater. See the external connections diagram on page 1.

CURRENT SENSE

The current of each phase can be read using the IMON output pins. The high side of each half bridge current is monitored separately. The current sense output level is as follows:

CHANNEL A: 1/4000th of the phase current.

CHANNEL B: 1/3600th of the phase current.

CHANNEL C: 1/3700th of the phase current.

External power current sense resistors are not required with the SA305. However, in order to read the current level using a standard A/D input a resistor of 1K Ω should be shunted across each output. A standard 1/4W resistor is sufficient here. Motor current adjustments are made through the PWM inputs. Above the internal limit the device self-protects.

SA305 OPERATION

The SA305 is used to drive three phase motors but can be used where ever three high current outputs are required. A DSP or microcontroller is used to control and monitor the operation of the SA305.

The current through each of the three P channel drive transistors is monitored by on-board circuitry. Current is set using the PWM inputs which drive each FET independently. Once the desired level is reached the inductance of the motor keeps the current near the programmed level. Should the current get to the internally set 12A level, the driver is shutdown to protect itself.

Whenever there are no “fault” conditions and the input controls indicate an output should be on, the P and N drivers will turn on. If the input controls are requiring that P-channel turn on before the N-channel turns off, the SA305 will automatically delay the P-channel turn on. The time between the N turning off and the P turning on or the P channel turning off and the N channel turning on is called dead time. An internally set minimum dead time assures no “shoot through” current and gives the clamp diode time to discharge.

The warning temperature setting is fixed at Tj= 135C. When the junction temperature gets to the programmed point, the temperature warning bit will be set. It will be reset when the temperature falls below the programmed limit.

The Fault temperature setting is fixed at Tj= 160C. Once the Fault temperature has been reached the Fault Output goes high and the outputs of the device are disabled. This output can be used as a microcontroller interrupt. The Fault latch will not be reset until the temperature is below the fault temperature setting.

If more than one output is required to be conducting large currents at the same time, the maximum current will need to be de-rated.