

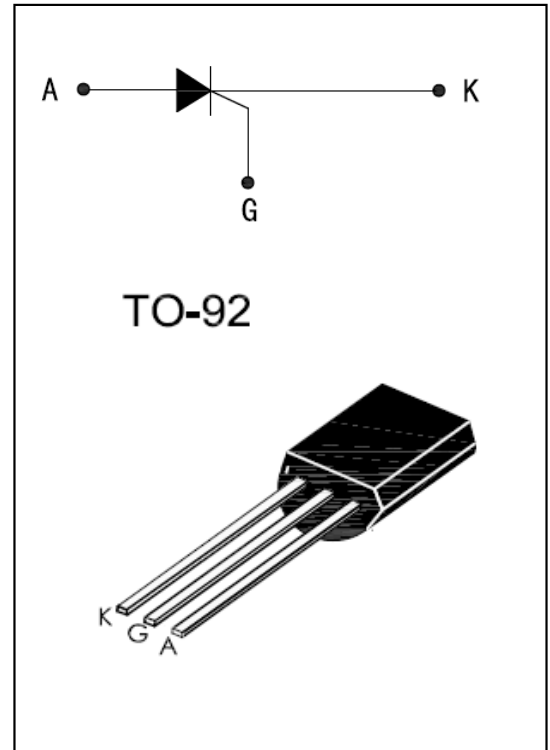

High sensitive triggering levels, the IPS6008 series SCRs is suitable for all applications, where the available gate current is limited, such as capacitive discharge ignitions, motor control in kitchen aids, overvoltage crowbar protection in low power supplies...

MAIN FEATURES

Symbol	Value	Unit
$I_{T(AV)}$	0.8	A
$V_{DRM} / V_{RRM}$	600	V
$I_{GT}$	$\leq 200$	$\mu A$



ABSOLUTE MAXIMUM RATINGS

Parameter	Symbol	Value	Unit
Storage Junction Temperature Range	$T_{stg}$	-40 to +150	$^{\circ}C$
Operating Junction Temperature Range	$T_j$	-40 to +125	$^{\circ}C$
Repetitive Peak Off-state Voltage	$V_{DRM}$	600	V
Repetitive Peak Reverse Voltage	$V_{RRM}$	600	V
RMS on-state current (180 conduction angle) $T_c = 77^{\circ}C$	$I_{T(RMS)}$	0.8	A
Average on-state current (180 conduction angle) $T_c = 77^{\circ}C$	$I_{T(AV)}$	0.5	A
Non repetitive surge peak on-state Current ( $T_j = 25^{\circ}C$ ) $t_p = 10\text{ ms}$ $t_p = 8.3\text{ ms}$	$I_{TSM}$	9 10	A
$I^2t$ Value for fusing $t_p = 10\text{ms}$	$I^2t$	0.415	$A^2s$
Peak gate current $t_p = 20\mu s, T_j = 110^{\circ}C$	$I_{GM}$	0.2	A
Average gate power dissipation $T_j = 110^{\circ}C$	$P_{G(AV)}$	0.1	W

## ELECTRICAL CHARACTERISTICS (T<sub>j</sub> = 25 °C unless otherwise specified)

Symbol	Test Condition		IPS6008-xxU				Unit
			03	05	06	08	
I <sub>GT</sub>	V <sub>D</sub> = 6V R <sub>L</sub> = 100Ω	MIN	10	20	30	50	uA
		MAX	30	50	60	80	
V <sub>GT</sub>		TYP	0.6				V
		MAX	0.8				
V <sub>GD</sub>	V <sub>D</sub> =V <sub>DRM</sub> , R <sub>L</sub> =3.3KΩ, R <sub>GK</sub> = 1KΩ T <sub>j</sub> = 110 °C	MIN	0.2				V
I <sub>L</sub>	I <sub>G</sub> = 1mA R <sub>GK</sub> = 1KΩ	MAX	6				mA
I <sub>H</sub>	I <sub>T</sub> = 50mA R <sub>GK</sub> = 1KΩ	MAX	5				mA
V <sub>TM</sub>	I <sub>T</sub> = 1A t <sub>p</sub> = 380uS T <sub>j</sub> = 25 °C	TYP	1.3				V/us
		MAX	1.7				
dV/dt	V <sub>D</sub> = 67% V <sub>DRM</sub> R <sub>GK</sub> = 1KΩ T <sub>j</sub> = 110 °C	MIN	10				V/us
I <sub>DRM</sub>	V <sub>D</sub> = V <sub>DRM</sub> R <sub>GK</sub> = 1KΩ T <sub>j</sub> = 25 °C	MAX	5				uA
	V <sub>D</sub> = V <sub>DRM</sub> R <sub>GK</sub> = 1KΩ T <sub>j</sub> = 110 °C	MAX	0.1				mA
I <sub>RRM</sub>	V <sub>R</sub> = V <sub>RRM</sub> R <sub>GK</sub> = 1KΩ T <sub>j</sub> = 25 °C	MAX	5				uA
	V <sub>D</sub> = V <sub>RRM</sub> R <sub>GK</sub> = 1KΩ T <sub>j</sub> = 110 °C	MAX	0.1				mA

Please ask the I<sub>GT</sub> values to our sales if you want to get another values.

## THERMAL RESISTANCES

Symbol	Parameter		Value	Unit
R <sub>th</sub> (j - c)	Junction to case	TO-92	75	°C/W

## PACKAGE MECHANICAL DATA

### TO-92

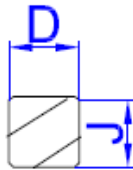
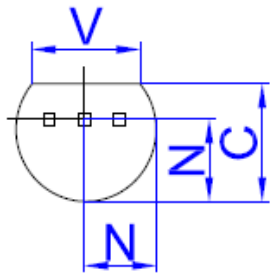

SECTION X-X

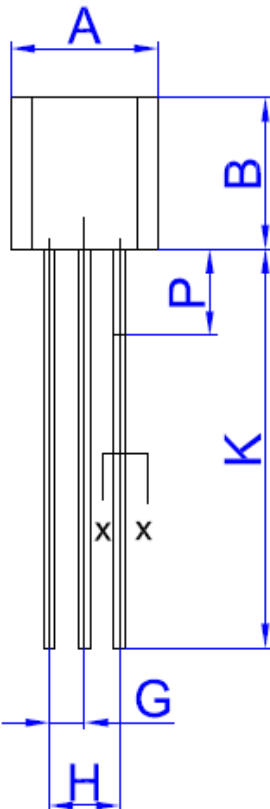

Ref	Dimensions			
	Millimeters		Inches	
	Min	Max	Min	Max
A	4.45	5.2	0.175	0.205
B	4.32	5.33	0.170	0.210
C	3.18	4.19	0.125	0.165
D	0.407	0.533	0.016	0.021
G	1.15	1.39	0.045	0.055
H	2.42	2.66	0.095	0.105
J	0.39	0.50	0.015	0.020
K	12.70	-	0.500	-
N	2.04	2.66	0.080	0.105
P	-	2.54	-	0.100
V	3.43	-	0.135	-

FIG.1: Maximum power dissipation versus RMS on-state current(full cycle)

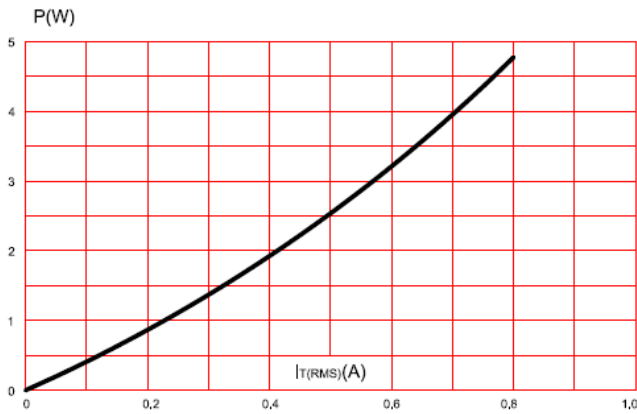

FIG.2: RMS on-state current versus case temperature(full cycle)

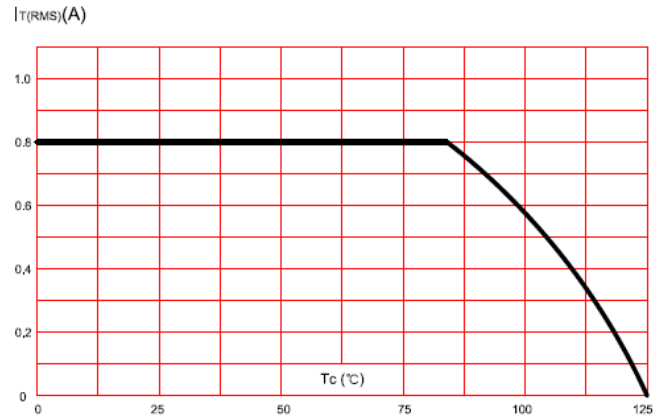

FIG.3: On-state characteristics (maximum values)

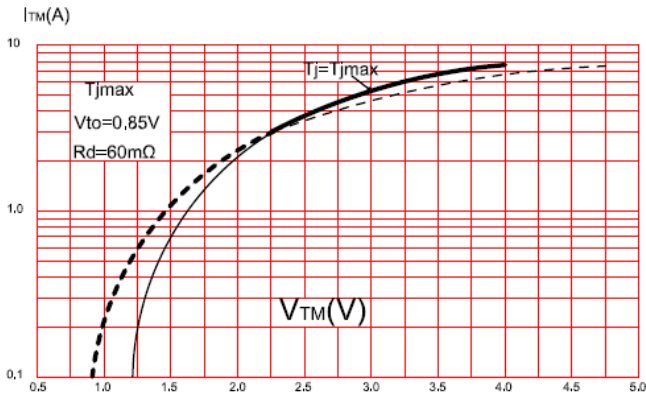

FIG.4: Surge peak on-state current versus number of cycles.

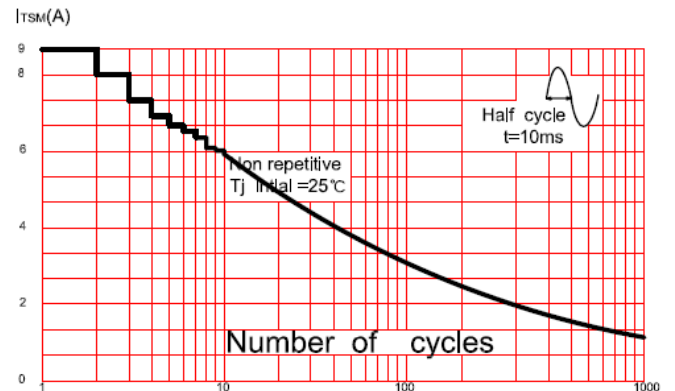

FIG.5: Non-repetitive surge peak on-state current for a sinusoidal pulse with width  $t_p < 10\text{ms}$ .

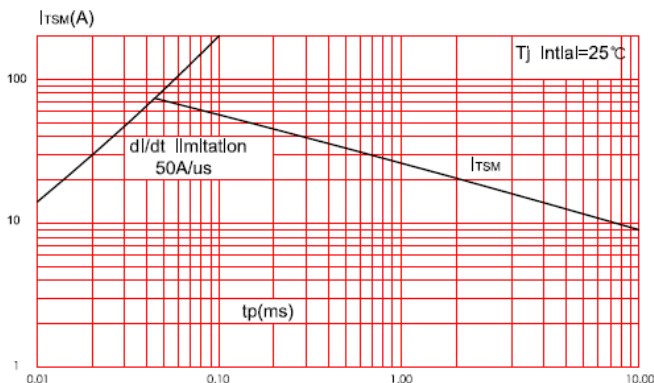

FIG.6: Relative variation of gate trigger current, holding current and latching current versus junction temperature(typical values).

