

# LM2756 Multi-Display Inductorless LED Driver with 32 Exponential Dimming Steps in micro SMD

## General Description

The LM2756 is a highly integrated, switched-capacitor, multi-display LED driver that can drive up to 8 LEDs in parallel with a total output current of 180mA. Regulated internal current sources deliver excellent current and brightness matching in all LEDs.

The LED driver current sinks are split into three independently controlled groups. The primary group (Group A) can be configured to drive four, five or six LEDs for use in the main phone display, while the secondary group (Group B) can be configured to drive one, two or three LEDs for driving secondary displays, keypads and/or indicator LEDs. An additional driver, D1C, is provided for additional indicator lighting functions.

The device provides excellent efficiency without the use of an inductor by operating the charge pump in a gain of 3/2 or in Pass-Mode. The proper gain for maintaining current regulation is chosen, based on LED forward voltage, so that efficiency is maximized over the input voltage range.

The LM2756 is available in National's tiny 20-bump, 0.4mm pitch, thin micro SMD package.

## Features

- Drives up to 8 LEDs with up to 30mA of Diode Current Each
- 32 Exponential Dimming Steps with 800:1 Dimming Ratio for Group A (Up to 6 LEDs)
- 8 Linear Dimming States for Groups B (Up to 3 LEDs) and D1C (1 LED)
- Programmable Auto-Dimming Function
- 3 Independently Controlled LED Groups Via I<sup>2</sup>C Compatible Interface
- Up to 90% Efficiency
- Total Solution Size < 21mm<sup>2</sup>
- Low Profile 20 Bump micro SMD Package (1.615mm × 2.015mm × 0.6mm)
- 0.4% Accurate Current Matching
- Internal Soft-Start Limits Inrush Current
- True Shutdown Isolation for LED's
- Wide Input Voltage Range (2.7V to 5.5V)
- Active High Hardware Enable

## Applications

- Dual Display LCD Backlighting for Portable Applications
- Large Format LCD Backlighting
- Display Backlighting with Indicator Light

## Typical Application Circuit

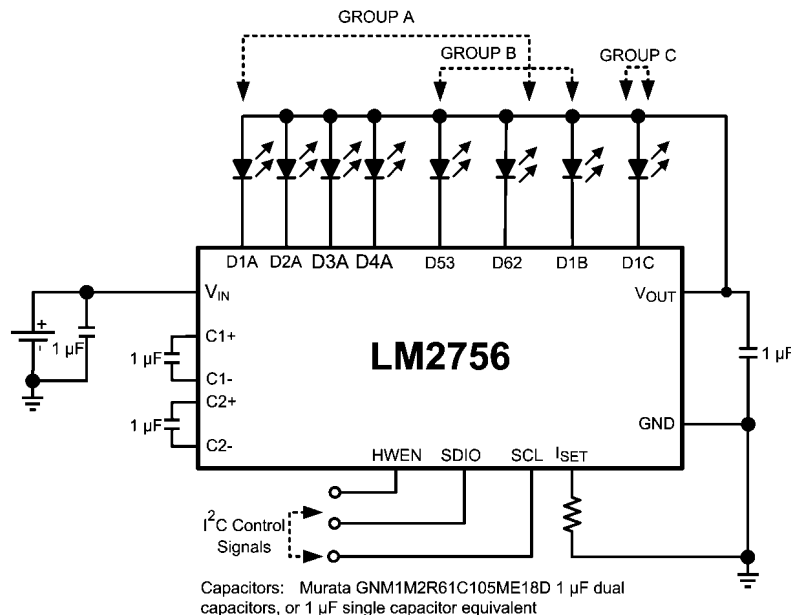

30009701

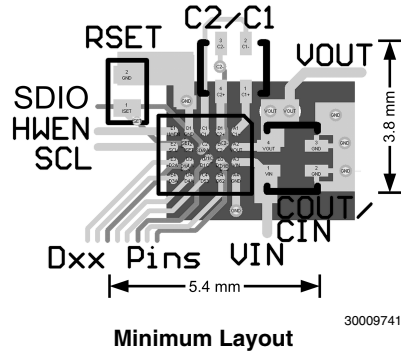

## Connection Diagram

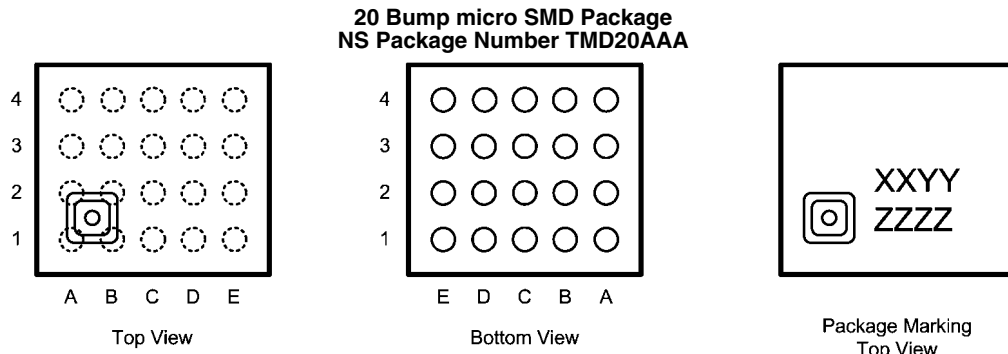

**Note:** The actual physical placement of the package marking will vary from part to part. The package marking "XX" designates the date code. "YY" is a NSC internal code for die traceability. Both will vary considerably. "ZZZZ" (placeholder until actual package ID is determined) identifies the device (part number, option, etc.).

30009702

## Pin Descriptions

Bump #s TMD20AAA	Pin Names	Pin Descriptions
A3	$V_{IN}$	Input voltage. Input range: 2.7V to 5.5V.
A2	$V_{OUT}$	Charge Pump Output Voltage
A1, C1, B1, B2	C1+, C1-, C2+, C2-	Flying Capacitor Connections
D3, E3, E4, D4	D1A-D4A	LED Drivers - GroupA
C4, B4	D53, D62	LED Drivers - Configurable Current Sinks. Can be assigned to GroupA or GroupB
B3	D1B	LED Drivers - GroupB
C3	D1C	LED Driver - Indicator LED
D2	$I_{SET}$	Placing a resistor ( $R_{SET}$ ) between this pin and GND sets the full-scale LED current for DxA , Dx B, D53, D62 and D1C LEDs. Full-Scale LED Current = $189 \times (1.25V \div R_{SET})$
E1	HWEN	Hardware Enable Pin. High = Normal Operation, Low = RESET
C2	SDIO	Serial Data Input/Output Pin
E2	SCL	Serial Clock Pin
A4, D1	GND	Ground

## Ordering Information

Order Information	Package	Supplied As
LM2756TM	TMD20AAA	250 Units, Tape & Reel
LM2756TMX		3000 Units, Tape & Reel

## Absolute Maximum Ratings (Notes 1, 2)

If Military/Aerospace specified devices are required, please contact the National Semiconductor Sales Office/Distributors for availability and specifications.

$V_{IN}$ pin voltage	-0.3V to 6.0V
SCL, SDIO, HWEN pin voltages	-0.3V to ( $V_{IN}+0.3V$ ) w/ 6.0V max
$I_{Dxx}$ Pin Voltages	-0.3V to ( $V_{VOUT}+0.3V$ ) w/ 6.0V max
Continuous Power Dissipation (Note 3)	Internally Limited
Junction Temperature ( $T_{J-MAX}$ )	150°C
Storage Temperature Range	-65°C to +150°C
Maximum Lead Temperature (Soldering)	(Note 4)
ESD Rating (Note 5)	
Human Body Model	2.0kV

## Operating Rating

(Notes 1, 2)

Input Voltage Range	2.7V to 5.5V
LED Voltage Range	2.0V to 4.0V
Junction Temperature ( $T_J$ ) Range	-30°C to +105°C
Ambient Temperature ( $T_A$ ) Range (Note 6)	-30°C to +85°C

## Thermal Properties

Junction-to-Ambient Thermal Resistance ( $\theta_{JA}$ ), TMD20 Package (Note 7)	40°C/W
--	--------

**ESD Caution Notice** National Semiconductor recommends that all integrated circuits be handled with appropriate ESD precautions. Failure to observe proper ESD handling techniques can result in damage to the device.

## Electrical Characteristics (Notes 2, 8)

Limits in standard typeface are for  $T_J = 25^\circ\text{C}$ , and limits in boldface type apply over the full operating temperature range. Unless otherwise specified:  $V_{IN} = 3.6V$ ;  $V_{HWEN} = V_{IN}$ ;  $V_{DxA} = V_{DxB} = V_{DxC} = 0.4V$ ;  $R_{SET} = 11.8k\Omega$ ; GroupA = GroupB = GroupC = Fullscale Current; ENA, ENB, ENC Bits = "1"; SD53, SD62, 53A, 62A Bits = "0";  $C_1 = C_2 = C_{IN} = C_{OUT} = 1.0\mu\text{F}$ ; Specifications related to output current(s) and current setting pins ( $I_{Dxx}$  and  $I_{SET}$ ) apply to GroupA and GroupB. (Note 9)

Symbol	Parameter	Condition	Min	Typ	Max	Units	
$I_{Dxx}$	Output Current Regulation GroupA	$2.7V \leq V_{IN} \leq 5.5V$ ENA = '1', 53A = 62A = '0', ENB = ENC = '0' 4 LEDs in GroupA	<b>18.65</b> <b>(-8%)</b>	20.28	<b>21.90</b> <b>(+8%)</b>	mA (%)	
		$2.7V \leq V_{IN} \leq 5.5V$ ENA = '1', 53A = 62A = '1', ENB = ENC = '0' 6 LEDs in GroupA	<b>18.70</b> <b>(-8.5%)</b>	20.40	<b>22.10</b> <b>(+8.5%)</b>	mA (%)	
	Output Current Regulation GroupB	$2.7V \leq V_{IN} \leq 5.5V$ ENB = '1', 53A = 62A = '0', ENA = ENC = '0' 3 LEDs in GroupB	<b>18.40</b> <b>(-8%)</b>	20.00	<b>21.60</b> <b>(+8%)</b>	mA (%)	
	Output Current Regulation IDC	$2.7V \leq V_{IN} \leq 5.5V$ ENC = '1', ENA = ENB = '0'	<b>18.20</b> <b>(-7.5%)</b>	19.70	<b>21.20</b> <b>(+7.5%)</b>	mA (%)	
	Maximum Diode Current per Dxx Output (Note 10)	$R_{SET} = 8.33k\Omega$			30	mA	
	Output Current Regulation GroupA, GroupB, and GroupC Enabled (Note 10)	$3.2V \leq V_{IN} \leq 5.5V$ $V_{LED} = 3.6V$ $R_{SET} = 10.5k\Omega$			22.5 DxA 22.5 DxB 22.5 DxC	mA	
$I_{Dxx-MATCH}$	LED Current Matching (Note 11)	$2.7V \leq V_{IN} \leq 5.5V$	GroupA (4 LEDs)		0.4	<b>1.8</b>	%
			GroupA (6 LEDs)		1.0	<b>2.7</b>	
			GroupB (3 LEDs)		0.7	<b>2.5</b>	
$V_{DxTH}$	$V_{Dxx}$ 1x to 3/2x Gain Transition Threshold	$V_{DxA}$ and/or $V_{DxB}$ Falling			150	mV	
$V_{HR}$	Current sink Headroom Voltage Requirement (Note 12)	$I_{Dxx} = 95\% \times I_{Dxx}(\text{nom.})$ $(I_{Dxx}(\text{nom.}) \approx 20\text{mA})$			65	mV	
$R_{OUT}$	Open-Loop Charge Pump Output Resistance	Gain = 3/2			2.4	$\Omega$	
		Gain = 1			0.9		
$I_Q$	Quiescent Supply Current	Gain = 1.5x, No Load			2.1	<b>2.5</b> mA	

Symbol	Parameter	Condition	Min	Typ	Max	Units
$I_{SD}$	Shutdown Supply Current	All ENx bits = "0"		3.7	5.5	$\mu\text{A}$
$V_{SET}$	$I_{SET}$ Pin Voltage	$2.7\text{V} \leq V_{IN} \leq 5.5\text{V}$		1.25		V
$I_{DxA-B-C} / I_{SET}$	Output Current to Current Set Ratio GroupA, GroupB, GroupC			189		
$f_{SW}$	Switching Frequency		1.0	1.3	1.6	MHz
$t_{START}$	Start-up Time	$V_{OUT} = 90\%$ steady state		250		$\mu\text{s}$
$V_{HWEN}$	HWEN Voltage Thresholds	$2.7\text{V} \leq V_{IN} \leq 5.5\text{V}$	Reset	0	0.580	V
			Normal Operation	1.075	$V_{IN}$	

### I<sup>2</sup>C Compatible Interface Voltage Specifications (SCL, SDIO)

$V_{IL}$	Input Logic Low "0"	$2.7\text{V} \leq V_{IN} \leq 5.5\text{V}$	0		0.710	V
$V_{IH}$	Input Logic High "1"	$2.7\text{V} \leq V_{IN} \leq 5.5\text{V}$	1.225		$V_{IN}$	V
$V_{OL}$	Output Logic Low "0"	$I_{LOAD} = 3.5\text{mA}$			400	mV

### I<sup>2</sup>C Compatible Interface Timing Specifications (SCL, SDIO)(Note 13)

$t_1$	SCL (Clock Period)	(Note 14)	294			ns
$t_2$	Data In Setup Time to SCL High		100			ns
$t_3$	Data Out stable After SCL Low		0			ns
$t_4$	SDIO Low Setup Time to SCL Low (Start)		100			ns
$t_5$	SDIO High Hold Time After SCL High		100			ns

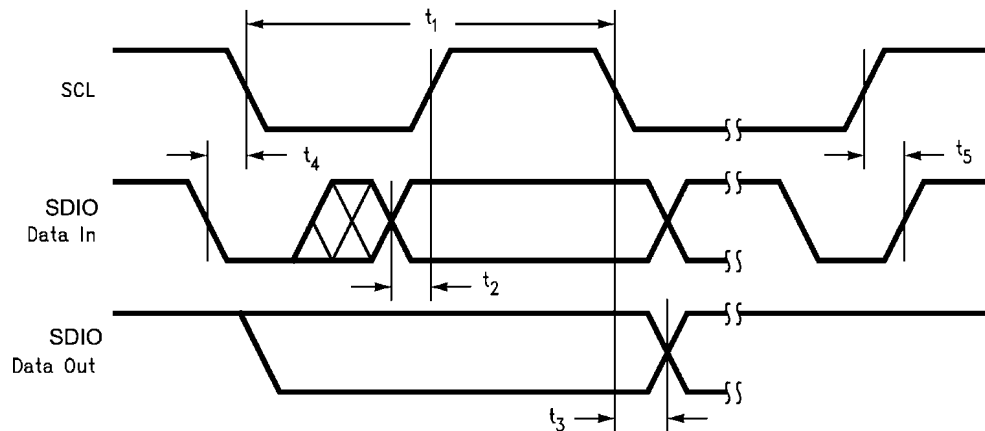

30009713

**Note 1:** Absolute Maximum Ratings indicate limits beyond which damage to the component may occur. Operating Ratings are conditions under which operation of the device is guaranteed. Operating Ratings do not imply guaranteed performance limits. For guaranteed performance limits and associated test conditions, see the Electrical Characteristics tables.

**Note 2:** All voltages are with respect to the potential at the GND pins.

**Note 3:** Internal thermal shutdown circuitry protects the device from permanent damage. Thermal shutdown engages at  $T_J = 160^\circ\text{C}$  (typ.) and disengages at  $T_J = 155^\circ\text{C}$  (typ.).

**Note 4:** For detailed soldering specifications and information, please refer to National Semiconductor Application Note 1112: Micro SMD Wafer Level Chip Scale Package (AN-1112).

**Note 5:** The human body model is a 100pF capacitor discharged through a 1.5k $\Omega$  resistor into each pin. (MIL-STD-883 3015.7)

**Note 6:** In applications where high power dissipation and/or poor package thermal resistance is present, the maximum ambient temperature may have to be derated. Maximum ambient temperature ( $T_{A-MAX}$ ) is dependent on the maximum operating junction temperature ( $T_{J-MAX-OP} = 105^\circ\text{C}$ ), the maximum power dissipation of the device in the application ( $P_{D-MAX}$ ), and the junction-to ambient thermal resistance of the part/package in the application ( $\theta_{JA}$ ), as given by the following equation:  $T_{A-MAX} = T_{J-MAX-OP} - (\theta_{JA} \times P_{D-MAX})$ .

**Note 7:** Junction-to-ambient thermal resistance is highly dependent on application and board layout. In applications where high maximum power dissipation exists, special care must be paid to thermal dissipation issues in board design. For more information, please refer to National Semiconductor Application Note 1112: Micro SMD Wafer Level Chip Scale Package (AN-1112).

**Note 8:** Min and Max limits are guaranteed by design, test, or statistical analysis. Typical numbers are not guaranteed, but do represent the most likely norm.

**Note 9:**  $C_{IN}$ ,  $C_{VOUT}$ ,  $C_1$ , and  $C_2$ : Low-ESR Surface-Mount Ceramic Capacitors (MLCCs) used in setting electrical characteristics

**Note 10:** The maximum total output current for the LM2756 should be limited to 180mA. The total output current can be split among any of the three Groups ( $I_{DxA} = I_{DxB} = I_{DxC} = 30\text{mA Max.}$ ). Under maximum output current conditions, special attention must be given to input voltage and LED forward voltage to ensure proper current regulation. See the Maximum Output Current section of the datasheet for more information.

**Note 11:** For the two groups of current sinks on a part (GroupA and GroupB), the following are determined: the maximum sink current in the group (MAX), the minimum sink current in the group (MIN), and the average sink current of the group (AVG). For each group, two matching numbers are calculated:  $(\text{MAX}-\text{AVG})/\text{AVG}$  and  $(\text{AVG}-\text{MIN})/\text{AVG}$ . The largest number of the two (worst case) is considered the matching figure for the Group. The matching figure for a given part is considered to be the highest matching figure of the two Groups. The typical specification provided is the most likely norm of the matching figure for all parts.

**Note 12:** For each Dxx pin, headroom voltage is the voltage across the internal current sink connected to that pin. For Group A, B, and C current sinks,  $V_{HRx} = V_{OUT} - V_{LED}$ . If headroom voltage requirement is not met, LED current regulation will be compromised.

**Note 13:** SCL and SDIO should be glitch-free in order for proper brightness control to be realized.

**Note 14:** SCL is tested with a 50% duty-cycle clock.

## Block Diagram

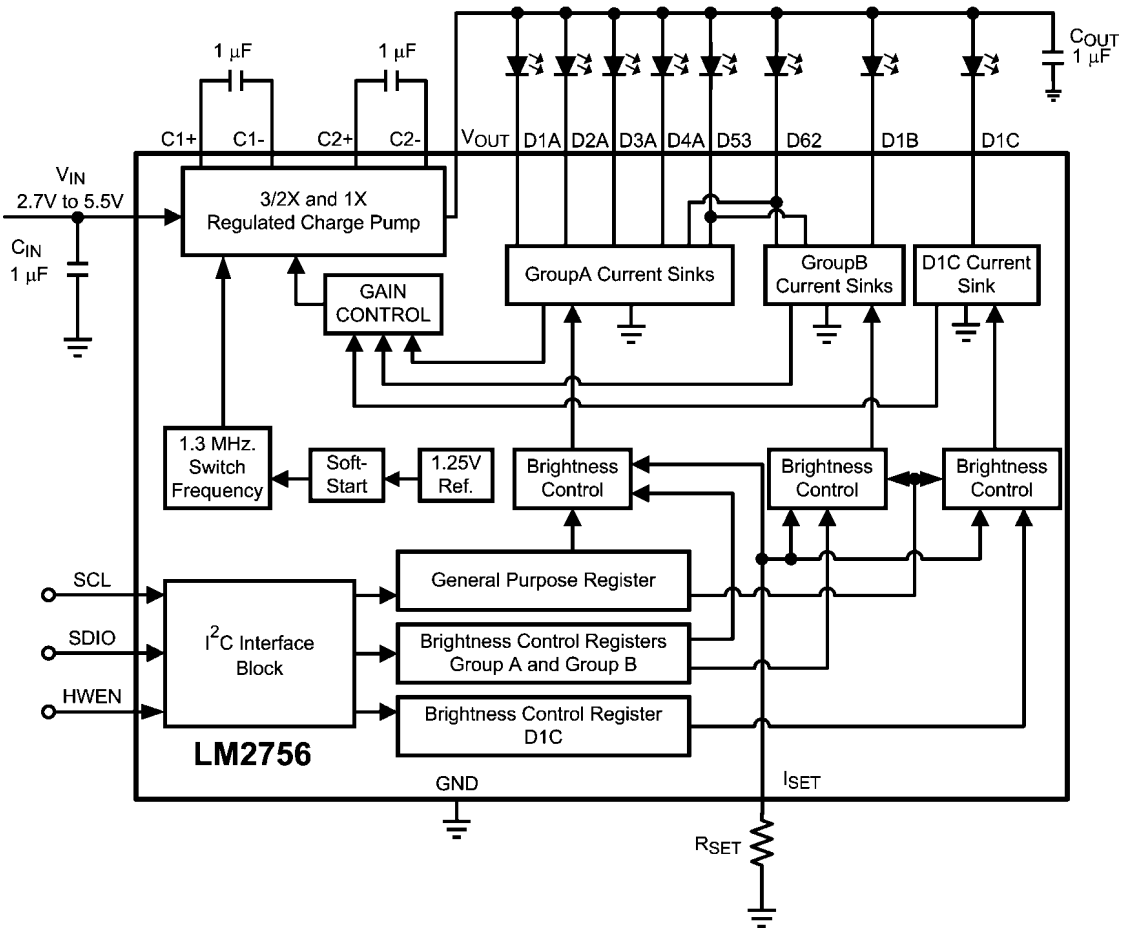

30009703

### Typical Performance Characteristics

Unless otherwise specified:  $T_A = 25^\circ\text{C}$ ;  $V_{IN} = 3.6\text{V}$ ;  $V_{HWEN} = V_{IN}$ ;  $V_{LEDxA} = V_{LEDxB} = V_{LEDxC} = 3.6\text{V}$ ;  $R_{SET} = 11.8\text{k}\Omega$ ;  $C_1=C_2=C_{IN} = C_{VOUT} = 1\mu\text{F}$ ;  $ENA = ENB = ENC = '1'$ .

**LED Drive Efficiency vs Input Voltage**

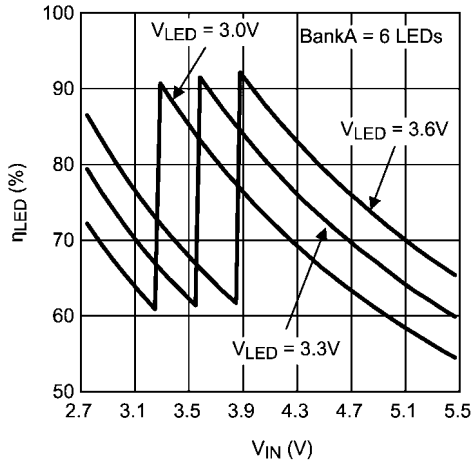

30009719

**LED Drive Efficiency vs Input Voltage**

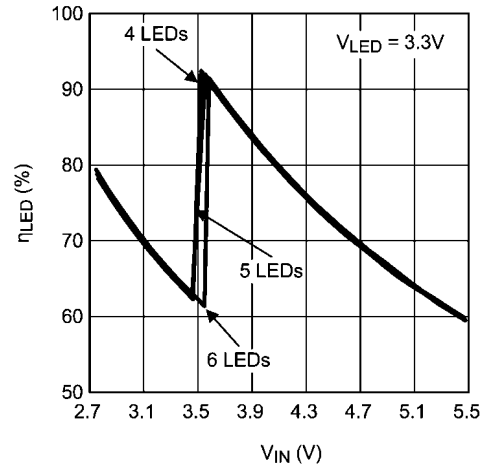

30009721

**Input Current vs Input Voltage**

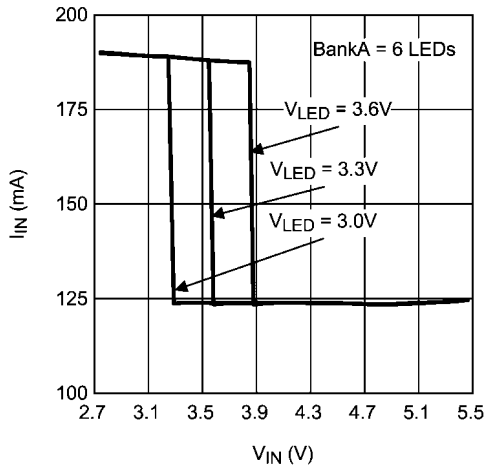

30009720

**GroupA Diode Current vs Input Voltage**

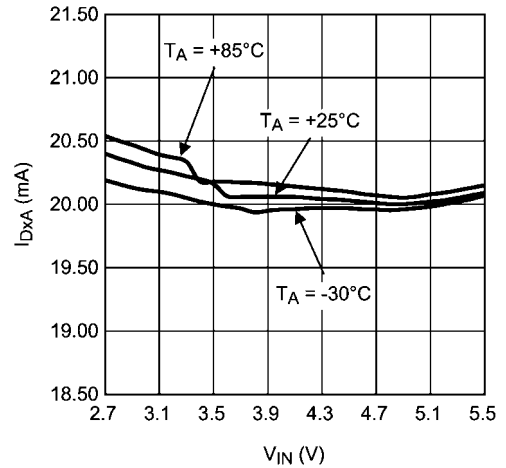

30009726

**GroupB Diode Current vs Input Voltage**

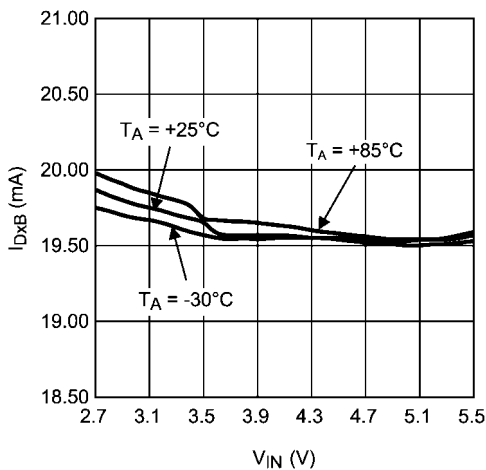

30009727

**GroupC Diode Current vs Input Voltage**

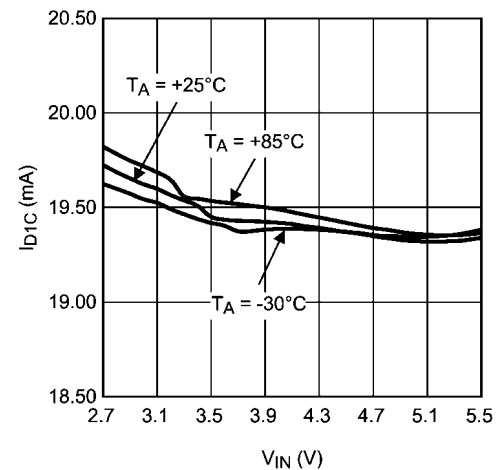

30009728

**GroupA Current Matching vs Input Voltage  
6 LEDs**

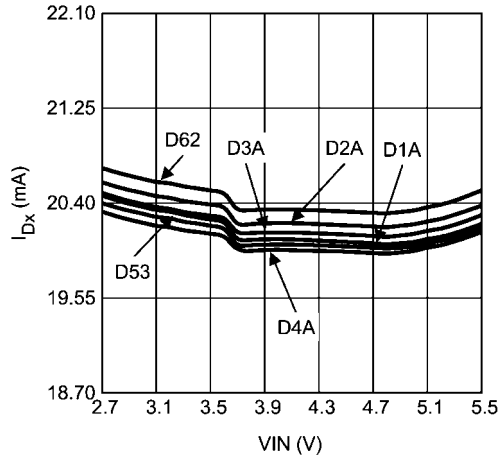

30009716

**GroupA Current Matching vs Input Voltage  
4 LEDs**

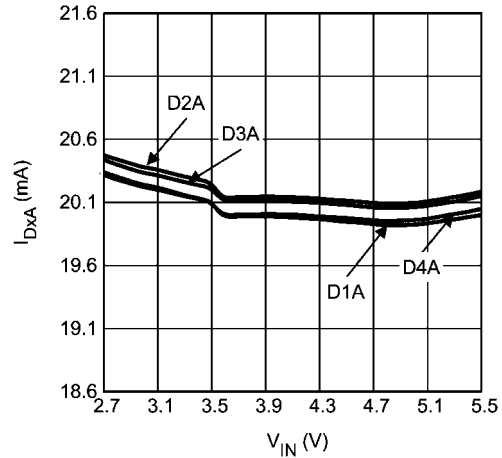

30009717

**GroupB Current Matching vs Input Voltage  
3 LEDs**

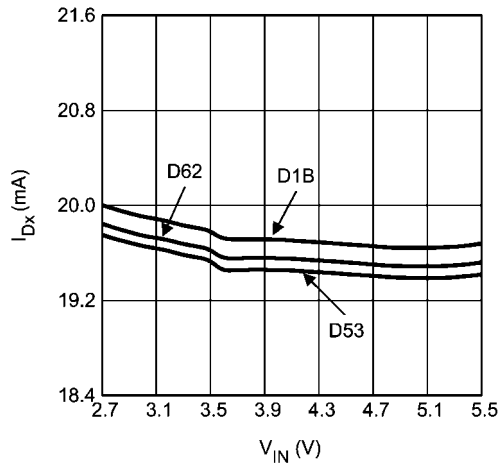

30009718

**GroupA Diode Current vs GroupA Brightness Code**

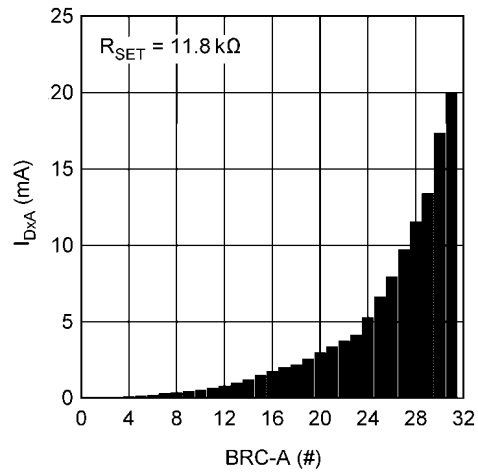

30009722

**GroupB Diode Current vs GroupB Brightness Code**

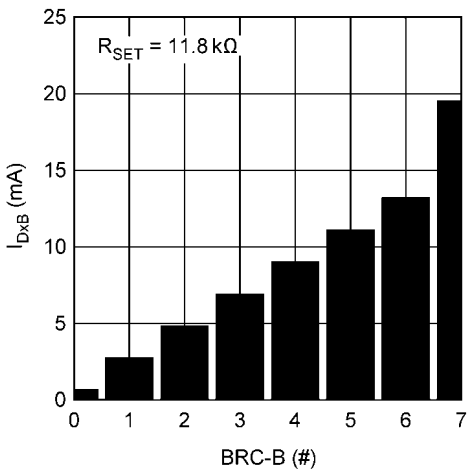

30009723

**GroupC Diode Current vs GroupC Brightness Code**

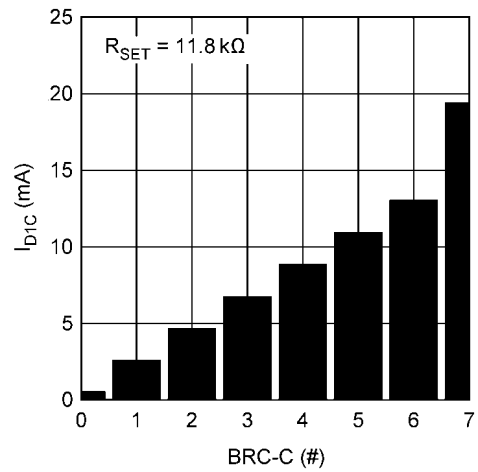

30009724

Quiescent Current in Gain 1.5x vs Input Voltage

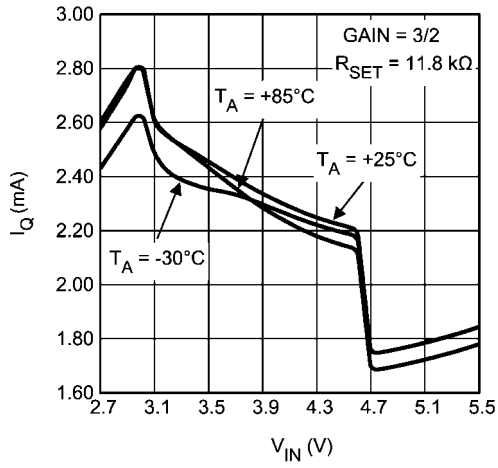

30009714

Shutdown Current vs Input Voltage

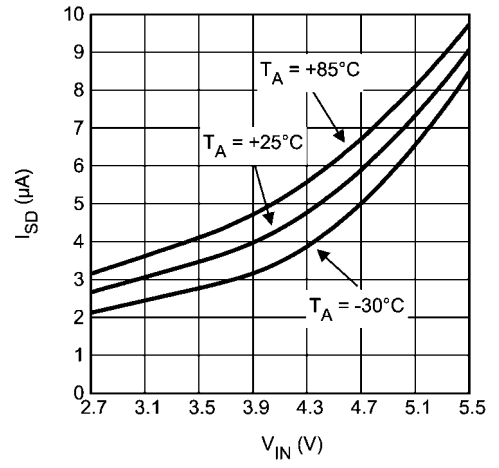

30009715



## Circuit Description

### OVERVIEW

The LM2756 is a white LED driver system based upon an adaptive 3/2x - 1x CMOS charge pump capable of supplying up to 180mA of total output current. With three separately controlled Groups of constant current sinks, the LM2756 is an ideal solution for platforms requiring a single white LED driver for main display, sub display, and indicator lighting. The tightly matched current sinks ensure uniform brightness from the LEDs across the entire small-format display.

Each LED is configured in a common anode configuration, with the peak drive current being programmed through the use of an external  $R_{SET}$  resistor. An I<sup>2</sup>C compatible interface is used to enable the device and vary the brightness within the individual current sink Groups. For GroupA, 32 exponentially-spaced analog brightness control levels are available. GroupB and GroupC have 8 linearly-spaced analog brightness levels.

### CIRCUIT COMPONENTS

#### Charge Pump

The input to the 3/2x - 1x charge pump is connected to the  $V_{IN}$  pin, and the regulated output of the charge pump is connected to the  $V_{OUT}$  pin. The recommended input voltage range of the LM2756 is 2.7V to 5.5V. The device's regulated charge pump has both open loop and closed loop modes of operation. When the device is in open loop, the voltage at  $V_{OUT}$  is equal to the gain times the voltage at the input. When the device is in closed loop, the voltage at  $V_{OUT}$  is regulated to 4.6V (typ.). The charge pump gain transitions are actively selected to maintain regulation based on LED forward voltage and load requirements.

#### LED Forward Voltage Monitoring

The LM2756 has the ability to switch gains (1x or 3/2x) based on the forward voltage of the LED load. This ability to switch gains maximizes efficiency for a given load. Forward voltage monitoring occurs on all diode pins. At higher input voltages, the LM2756 will operate in pass mode, allowing the  $V_{OUT}$  voltage to track the input voltage. As the input voltage drops, the voltage on the Dxx pins will also drop ( $V_{DXX} = V_{VOUT} - V_{LEDX}$ ). Once any of the active Dxx pins reaches a voltage approximately equal to 150mV, the charge pump will switch to the gain of 3/2. This switch-over ensures that the current through the LEDs never becomes pinched off due to a lack of headroom across the current sinks. **Once a gain transition occurs, the LM2756 will remain in the gain of 3/2 until an I<sup>2</sup>C write to the part occurs. At that time, the LM2756 will re-evaluate the LED conditions and select the appropriate gain.**

Only active Dxx pins will be monitored. For example, if only GroupA is enabled, the LEDs in GroupB or GroupC will not affect the gain transition point. If all 3 Groups are enabled, all diodes will be monitored, and the gain transition will be based upon the diode with the highest forward voltage.

#### Configurable Gain Transition Delay

To optimize efficiency, the LM2756 has a user selectable gain transition delay that allows the part to ignore short duration input voltage drops. By default, the LM2756 will not change gains if the input voltage dip is shorter than 3 to 6 milliseconds. There are four selectable gain transition delay ranges available on the LM2756. All delay ranges are set within the VF Monitor Delay Register. Please refer to the *INTERNAL REG-*

*ISTERS* section of this datasheet for more information regarding the delay ranges.

#### HWEN Pin

The LM2756 has a hardware enable/reset pin (HWEN) that allows the device to be disabled by an external controller without requiring an I<sup>2</sup>C write command. Under normal operation, the HWEN pin should be held high (logic '1') to prevent an unwanted reset. When the HWEN is driven low (logic '0'), all internal control registers reset to the default states and the part becomes disabled. Please see the *Electrical Characteristics* section of the datasheet for required voltage thresholds.

#### I<sup>2</sup>C Compatible Interface

##### DATA VALIDITY

The data on SDIO line must be stable during the HIGH period of the clock signal (SCL). In other words, state of the data line can only be changed when SCL is LOW.

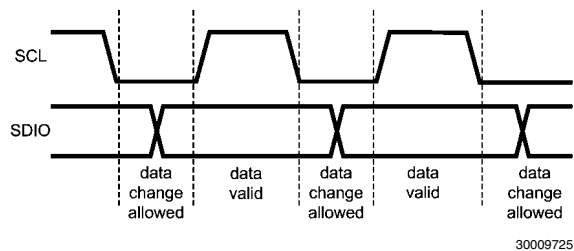

FIGURE 1. Data Validity Diagram

A pull-up resistor between the controller's VIO line and SDIO must be greater than  $[(VIO - V_{OL}) / 3.5mA]$  to meet the  $V_{OL}$  requirement on SDIO. Using a larger pull-up resistor results in lower switching current with slower edges, while using a smaller pull-up results in higher switching currents with faster edges.

#### START AND STOP CONDITIONS

START and STOP conditions classify the beginning and the end of the I<sup>2</sup>C session. A START condition is defined as SDIO signal transitioning from HIGH to LOW while SCL line is HIGH. A STOP condition is defined as the SDIO transitioning from LOW to HIGH while SCL is HIGH. The I<sup>2</sup>C master always generates START and STOP conditions. The I<sup>2</sup>C bus is considered to be busy after a START condition and free after a STOP condition. During data transmission, the I<sup>2</sup>C master can generate repeated START conditions. First START and repeated START conditions are equivalent, function-wise.

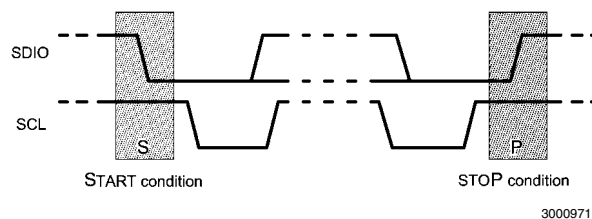

FIGURE 2. Start and Stop Conditions

#### TRANSFERRING DATA

Every byte put on the SDIO line must be eight bits long, with the most significant bit (MSB) transferred first. Each byte of data has to be followed by an acknowledge bit. The acknowledge related clock pulse is generated by the master. The

master releases the SDIO line (HIGH) during the acknowledge clock pulse. The LM2756 pulls down the SDIO line during the 9th clock pulse, signifying an acknowledge. The LM2756 generates an acknowledge after each byte is received.

After the START condition, the I<sup>2</sup>C master sends a chip address. This address is seven bits long followed by an eighth

bit which is a data direction bit (R/W). The LM2756 address is 36h. For the eighth bit, a "0" indicates a WRITE and a "1" indicates a READ. The second byte selects the register to which the data will be written. The third byte contains data to write to the selected register.

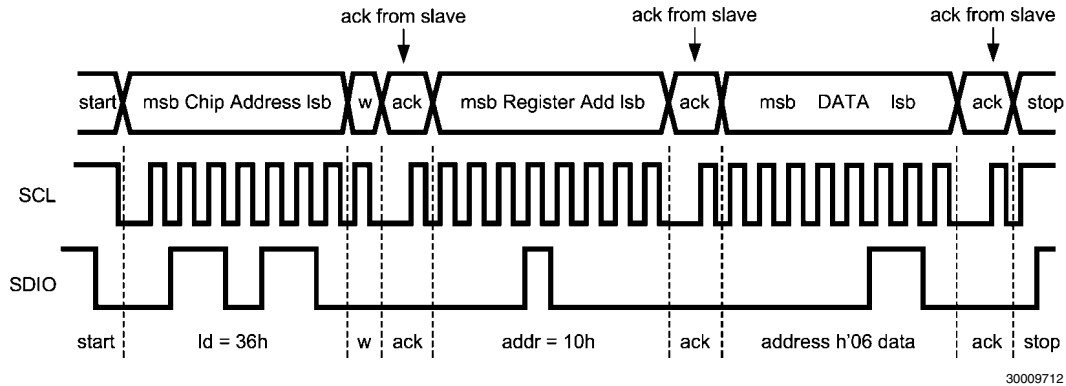

**FIGURE 3. Write Cycle**  
**w = write (SDIO = "0")**  
**r = read (SDIO = "1")**  
**ack = acknowledge (SDIO pulled down by either master or slave)**  
**id = chip address, 36h for LM2756**

**I<sup>2</sup>C COMPATIBLE CHIP ADDRESS**

The chip address for LM2756 is 0110110, or 36h.

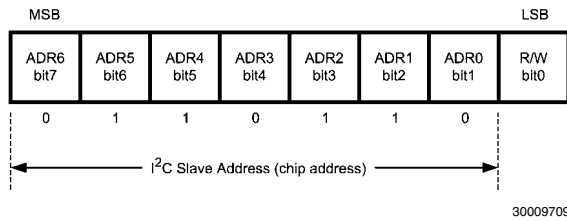

**FIGURE 4. Chip Address**

**INTERNAL REGISTERS OF LM2756**

Register	Internal Hex Address	Power On Value
General Purpose Register	10h	0000 0000
Group A Brightness Control Register	A0h	1110 0000
Group B Brightness Control Register	B0h	1111 1000
Group C Brightness Control Register	C0h	1111 1000
Ramp Step Time Register	20h	1111 0000
VF Monitor Delay Register	60h	1111 1100

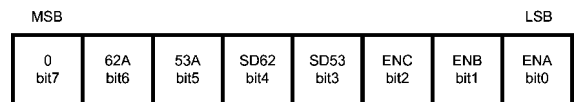

**FIGURE 5. General Purpose Register Description**  
**Internal Hex Address: 10h**

- Note:** ENA: Enables DxA LED drivers (Main Display)  
 ENB: Enables DxB LED drivers (Aux Lighting)  
 ENC: Enables D1C LED driver (Indicator Lighting)  
 SD53: Shuts down driver D53  
 SD62: Shuts down driver D62  
 53A: Configures D53 to GroupA  
 62A: Configures D62 to GroupA

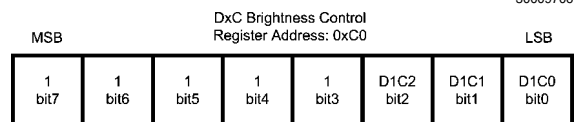
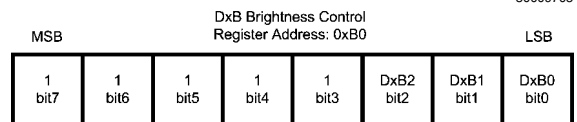
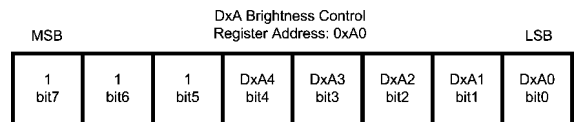

**FIGURE 6. Brightness Control Register Description**

**Internal Hex Address: 0xA0 (GroupA), 0xB0 (GroupB), 0xC0 (GroupC)**

**Note:** Dx44-DxA0, D53, D62: Sets Brightness for DxA pins (GroupA). 11111=Fullscale

DxB2-DxB0: Sets Brightness for DxB pins (GroupB). 111=Fullscale

DxC2-DxC0: Sets Brightness for D1C pin. 111 = Fullscale

Full-Scale Current set externally by the following equation:

$$I_{Dxx} = 189 \times 1.25V / R_{SET}$$

## Brightness Level Control Table (GroupA)

Brightness Code (hex)	Perceived Brightness Level (%)
00	0.125
01	0.313
02	0.625
03	1
04	1.125
05	1.313
06	1.688
07	2.063
08	2.438
09	2.813
0A	3.125
0B	3.75
0C	4.375
0D	5.25
0E	6.25
0F	7.5
10	8.75
11	10
12	12.5
13	15
14	16.875
15	18.75
16	22.5
17	26.25
18	31.25
19	37.5
1A	43.75
1B	52.5
1C	61.25
1D	70
1E	87.5
1F	100

GroupB and GroupC Brightness Levels (% of Full-Scale) = 10%, 20%, 30%, 40%, 50%, 60%, 70%, 100%

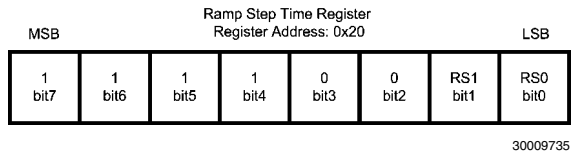

**FIGURE 7. Ramp Step Time Register Description**  
Internal Hex Address: 20h

**Note:** RS1-RS0: Sets Brightness Ramp Step Time. The Brightness ramp settings only affect GroupA current sinks. ('00' = 100µs, '01' = 25ms, '10' = 50ms, '11' = 100ms).

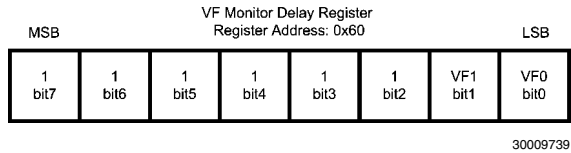

**FIGURE 8. VF Monitor Delay Register Description**  
Internal Hex Address: 60h

**Note:** VF1-VF0: Sets the Gain Transition Delay Time. The VF Monitor Delay can be set to four different delay times. ('00' (Default) = 3-6msec., '01' = 1.5-3msec., '10' = 0.4-0.8msec., '11' = 60-90µsec.).

## Application Information

### LED CONFIGURATIONS

The LM2756 has a total of 8 current sinks capable of sinking 180mA of total diode current. These 8 current sinks are configured to operate in three independently controlled lighting regions. GroupA has four dedicated current sinks, while GroupB and GroupC each have one. To add greater lighting flexibility, the LM2756 has two additional drivers (D53 and D62) that can be assigned to either GroupA or GroupB through a setting in the general purpose register.

At start-up, the default condition is four LEDs in GroupA, three LEDs in GroupB and a single LED in GroupC (NOTE: GroupC only consists of a single current sink (D1C) under any configuration). Bits 53A and 62A in the general purpose register control where current sinks D53 and D62 are assigned. By writing a '1' to the 53A or 62A bits, D53 and D62 become assigned to the GroupA lighting region. Writing a '0' to these bits assigns D53 and D62 to the GroupB lighting region. With this added flexibility, the LM2756 is capable of supporting applications requiring 4, 5, or 6 LEDs for main display lighting, while still providing additional current sinks that can be used for a wide variety of lighting functions.

### SETTING LED CURRENT

The current through the LEDs connected to DxA and DxB can be set to a desired level simply by connecting an appropriately sized resistor ( $R_{SET}$ ) between the  $I_{SET}$  pin of the LM2756 and GND. The DxA, DxB and D1C LED currents are proportional to the current that flows out of the  $I_{SET}$  pin and are a factor of 189 times greater than the  $I_{SET}$  current. The feedback loops of the internal amplifiers set the voltage of the  $I_{SET}$  pin to 1.25V (typ.). The statements above are simplified in the equations below:

$$I_{DxA/B/C} (A) = 189 \times (V_{ISET} / R_{SET})$$

$$R_{SET} (\Omega) = 189 \times (1.25V / I_{DxA/B/C})$$

Once the desired  $R_{SET}$  value has been chosen, the LM2756 has the ability to internally dim the LEDs using analog current scaling. The analog current level is set through the I<sup>2</sup>C compatible interface. LEDs connected to GroupA can be dimmed

to 32 different levels. GroupB and GroupC(D1C) have 8 analog current levels.

Please refer to the I<sup>2</sup>C Compatible Interface section of this datasheet for detailed instructions on how to adjust the brightness control registers.

### LED CURRENT RAMPING

The LM2756 provides an internal LED current ramping function that allows the GroupA LEDs to turn on and turn off gradually over time. The target current level is set in the GroupA Brightness Control Register (0xA0). The total ramp-up/ramp-down time is determined by the GroupA brightness level (0-31) and the user configurable ramp step time.

Bits RS1 and RS2 in the Ramp Step Time Register (0x20) set the ramp step time to the following four times: '00' = 100µsec., '01' = 25msec., '10' = 50msec., '11' = 100msec.

The LM2756 will always ramp-up (upon enable) and ramp-down (upon disable) through the brightness levels until the target level is reached. At the default setting of '00', the LM2756's current ramping feature looks more like a current step rather than a current ramp. The following table gives the approximate ramp-up/ramp-down times if the GroupA brightness register is set to full-scale, or brightness code 31.

**Brightness Ramp-Up/Ramp-Down Times**

Ramp Code RS1-RS0	Ramp Step Time	Total Ramp Time
00	100µs	3.2ms
01	25ms	0.8s
10	50ms	1.6s
11	100ms	3.2s

### MAXIMUM OUTPUT CURRENT, MAXIMUM LED VOLTAGE, MINIMUM INPUT VOLTAGE

The LM2756 can drive 8 LEDs at 22.5mA each (GroupA, GroupB, GroupC) from an input voltage as low as 3.2V, so long as the LEDs have a forward voltage of 3.6V or less (room temperature).

The statement above is a simple example of the LED drive capability of the LM2756. The statement contains the key application parameters that are required to validate an LED-drive design using the LM2756: LED current ( $I_{LEDx}$ ), number of active LEDs ( $N_x$ ), LED forward voltage ( $V_{LED}$ ), and minimum input voltage ( $V_{IN-MIN}$ ).

The equation below can be used to estimate the maximum output current capability of the LM2756:

$$I_{LED\_MAX} = \frac{[(1.5 \times V_{IN}) - V_{LED} - (I_{ADDITIONAL} \times R_{OUT})]}{[(N_x \times R_{OUT}) + k_{HRx}] \text{ (eq. 1)}}$$

$$I_{LED\_MAX} = \frac{[(1.5 \times V_{IN}) - V_{LED} - (I_{ADDITIONAL} \times 2.4\Omega)]}{[(N_x \times 2.4\Omega) + k_{HRx}]}$$

$I_{ADDITIONAL}$  is the additional current that could be delivered to the other LED Groups.

$R_{OUT}$  – Output resistance. This parameter models the internal losses of the charge pump that result in voltage droop at the pump output  $V_{OUT}$ . Since the magnitude of the voltage droop is proportional to the total output current of the charge pump, the loss parameter is modeled as a resistance. The output resistance of the LM2756 is typically 2.4Ω ( $V_{IN} = 3.6V$ ,  $T_A = 25^\circ C$ ). In equation form:

$$V_{VOUT} = (1.5 \times V_{IN}) - \frac{[(N_A \times I_{LEDA} + N_B \times I_{LEDB} + N_C \times I_{LEDC}) \times R_{OUT}]}{\text{(eq. 2)}}$$

$k_{HR}$  – Headroom constant. This parameter models the minimum voltage required to be present across the current sinks for them to regulate properly. This minimum voltage is proportional to the programmed LED current, so the constant has units of mV/mA. The typical  $k_{HR}$  of the LM2756 is 3.25mV/mA. In equation form:

$$(V_{VOUT} - V_{LEDx}) > k_{HRx} \times I_{LEDx} \text{ (eq. 3)}$$

### Typical Headroom Constant Values

$$k_{HRA} = k_{HRB} = k_{HRC} = 3.25 \text{ mV/mA}$$

The " $I_{LED-MAX}$ " equation (eq. 1) is obtained from combining the  $R_{OUT}$  equation (eq. 2) with the  $k_{HRx}$  equation (eq. 3) and solving for  $I_{LEDx}$ . Maximum LED current is highly dependent on minimum input voltage and LED forward voltage. Output current capability can be increased by raising the minimum input voltage of the application, or by selecting an LED with a lower forward voltage. Excessive power dissipation may also limit output current capability of an application.

### Total Output Current Capability

The maximum output current that can be drawn from the LM2756 is 180mA. Each driver Group has a maximum allotted current per Dxx sink that must not be exceeded.

DRIVER TYPE	MAXIMUM Dxx CURRENT
DxA	30mA per DxA Pin
DxB	30mA per DxB Pin
D1C	30mA

The 180mA load can be distributed in many different configurations. Special care must be taken when running the LM2756 at the maximum output current to ensure proper functionality.

### PARALLEL CONNECTED AND UNUSED OUTPUTS

Connecting the outputs in parallel does not affect internal operation of the LM2756 and has no impact on the Electrical Characteristics and limits previously presented. The available diode output current, maximum diode voltage, and all other specifications provided in the Electrical Characteristics table apply to this parallel output configuration, just as they do to the standard LED application circuit.

All Dx current sinks utilize LED forward voltage sensing circuitry to optimize the charge-pump gain for maximum efficiency. Due to the nature of the sensing circuitry, it is not recommended to leave any of the DxA (D1A-D4A, D53, D62) pins open if diode GroupA is going to be used during normal operation. Leaving DxA pins unconnected will force the charge-pump into 3/2x mode over the entire  $V_{IN}$  range negating any efficiency gain that could have been achieved by switching to 1x mode at higher input voltages.

If the D1B or D1C drivers are not going to be used, make sure that the ENB and ENC bits in the general purpose register are set to '0' to ensure optimal efficiency.

The D53 and D62 pins can be completely shutdown through the general purpose register by writing a '1' to the SD53 or SD62 bits.

Care must be taken when selecting the proper  $R_{SET}$  value. The current on any DxX pin must not exceed the maximum current rating for any given current sink pin.

### POWER EFFICIENCY

Efficiency of LED drivers is commonly taken to be the ratio of power consumed by the LEDs ( $P_{LED}$ ) to the power drawn at the input of the part ( $P_{IN}$ ). With a 3/2x - 1x charge pump, the input current is equal to the charge pump gain times the output

current (total LED current). The efficiency of the LM2756 can be predicted as follows:

$$P_{LEDTOTAL} = (V_{LEDA} \times N_A \times I_{LEDA}) + (V_{LEDB} \times N_B \times I_{LEDB}) + (V_{LEDC} \times I_{LEDC})$$

$$P_{IN} = V_{IN} \times I_{IN}$$

$$P_{IN} = V_{IN} \times (GAIN \times I_{LEDTOTAL} + I_Q)$$

$$E = (P_{LEDTOTAL} \div P_{IN})$$

The LED voltage is the main contributor to the charge-pump gain selection process. Use of low forward-voltage LEDs (3.0V- to 3.5V) will allow the LM2756 to stay in the gain of 1× for a higher percentage of the lithium-ion battery voltage range when compared to the use of higher forward voltage LEDs (3.5V to 4.0V). See the *LED Forward Voltage Monitoring* section of this datasheet for a more detailed description of the gain selection and transition process.

For an advanced analysis, it is recommended that power consumed by the circuit ( $V_{IN} \times I_{IN}$ ) for a given load be evaluated rather than power efficiency.

### POWER DISSIPATION

The power dissipation ( $P_{DISS}$ ) and junction temperature ( $T_J$ ) can be approximated with the equations below.  $P_{IN}$  is the power generated by the 3/2× - 1× charge pump,  $P_{LED}$  is the power consumed by the LEDs,  $T_A$  is the ambient temperature, and  $\theta_{JA}$  is the junction-to-ambient thermal resistance for the micro SMD 20-bump package.  $V_{IN}$  is the input voltage to the LM2756,  $V_{LED}$  is the nominal LED forward voltage, N is the number of LEDs and  $I_{LED}$  is the programmed LED current.

$$P_{DISS} = P_{IN} - P_{LEDA} - P_{LEDB} - P_{LEDC}$$

$$P_{DISS} = (GAIN \times V_{IN} \times I_{GroupA + GroupB + GroupC}) - (V_{LEDA} \times N_A \times I_{LEDA}) - (V_{LEDB} \times N_B \times I_{LEDB}) - (V_{LEDC} \times I_{LEDC})$$

$$T_J = T_A + (P_{DISS} \times \theta_{JA})$$

The junction temperature rating takes precedence over the ambient temperature rating. The LM2756 may be operated outside the ambient temperature rating, so long as the junction temperature of the device does not exceed the maximum operating rating of 105°C. The maximum ambient temperature rating must be derated in applications where high power

dissipation and/or poor thermal resistance causes the junction temperature to exceed 105°C.

### THERMAL PROTECTION

Internal thermal protection circuitry disables the LM2756 when the junction temperature exceeds 160°C (typ.). This feature protects the device from being damaged by high die temperatures that might otherwise result from excessive power dissipation. The device will recover and operate normally when the junction temperature falls below 155°C (typ.). It is important that the board layout provide good thermal conduction to keep the junction temperature within the specified operating ratings.

### CAPACITOR SELECTION

The LM2756 requires 4 external capacitors for proper operation ( $C_1 = C_2 = C_{IN} = C_{OUT} = 1\mu F$ ). Surface-mount multi-layer ceramic capacitors are recommended. These capacitors are small, inexpensive and have very low equivalent series resistance (ESR <20mΩ typ.). Tantalum capacitors, OS-CON capacitors, and aluminum electrolytic capacitors are not recommended for use with the LM2756 due to their high ESR, as compared to ceramic capacitors.

For most applications, ceramic capacitors with X7R or X5R temperature characteristic are preferred for use with the LM2756. These capacitors have tight capacitance tolerance (as good as ±10%) and hold their value over temperature (X7R: ±15% over -55°C to 125°C; X5R: ±15% over -55°C to 85°C).

Capacitors with Y5V or Z5U temperature characteristic are generally not recommended for use with the LM2756. Capacitors with these temperature characteristics typically have wide capacitance tolerance (+80%, -20%) and vary significantly over temperature (Y5V: +22%, -82% over -30°C to +85°C range; Z5U: +22%, -56% over +10°C to +85°C range). Under some conditions, a nominal 1μF Y5V or Z5U capacitor could have a capacitance of only 0.1μF. Such detrimental deviation is likely to cause Y5V and Z5U capacitors to fail to meet the minimum capacitance requirements of the LM2756.

**The recommended voltage rating for the capacitors is 10V to account for DC bias capacitance losses.**

**Physical Dimensions** inches (millimeters) unless otherwise noted

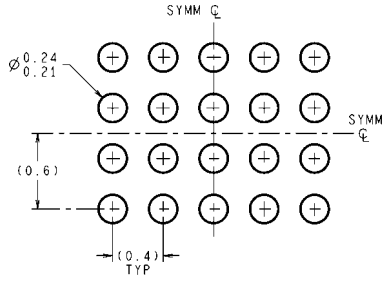

**LAND PATTERN RECOMMENDATION**

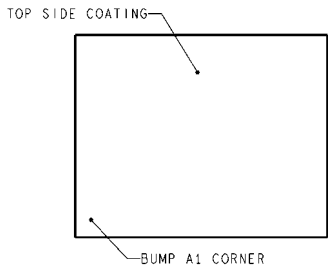

**DIMENSIONS ARE IN MILLIMETERS**  
DIMENSIONS IN ( ) FOR REFERENCE ONLY

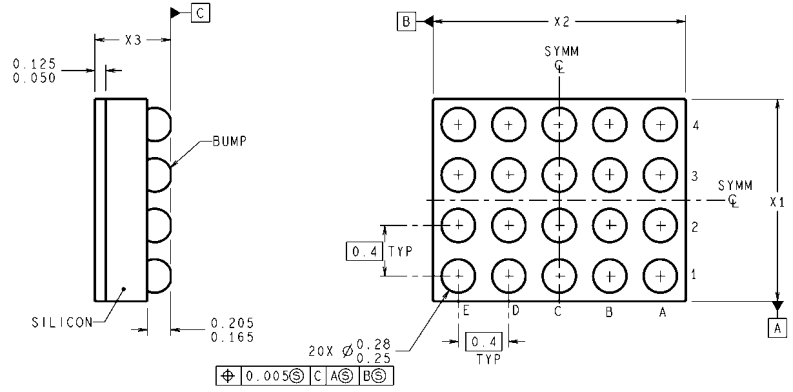

**TMD20AAA: 20 Bump 0.4mm micro SMD**  
**X1 = 1.615mm**  
**X2 = 2.015mm**  
**X3 = 0.6mm**

TMD20XXX (Rev D)

# Notes

LM2756

## Notes

For more National Semiconductor product information and proven design tools, visit the following Web sites at:

Products		Design Support	
Amplifiers	<a href="http://www.national.com/amplifiers">www.national.com/amplifiers</a>	WEBENCH	<a href="http://www.national.com/webench">www.national.com/webench</a>
Audio	<a href="http://www.national.com/audio">www.national.com/audio</a>	Analog University	<a href="http://www.national.com/AU">www.national.com/AU</a>
Clock Conditioners	<a href="http://www.national.com/timing">www.national.com/timing</a>	App Notes	<a href="http://www.national.com/appnotes">www.national.com/appnotes</a>
Data Converters	<a href="http://www.national.com/adc">www.national.com/adc</a>	Distributors	<a href="http://www.national.com/contacts">www.national.com/contacts</a>
Displays	<a href="http://www.national.com/displays">www.national.com/displays</a>	Green Compliance	<a href="http://www.national.com/quality/green">www.national.com/quality/green</a>
Ethernet	<a href="http://www.national.com/ethernet">www.national.com/ethernet</a>	Packaging	<a href="http://www.national.com/packaging">www.national.com/packaging</a>
Interface	<a href="http://www.national.com/interface">www.national.com/interface</a>	Quality and Reliability	<a href="http://www.national.com/quality">www.national.com/quality</a>
LVDS	<a href="http://www.national.com/lvds">www.national.com/lvds</a>	Reference Designs	<a href="http://www.national.com/refdesigns">www.national.com/refdesigns</a>
Power Management	<a href="http://www.national.com/power">www.national.com/power</a>	Feedback	<a href="http://www.national.com/feedback">www.national.com/feedback</a>
Switching Regulators	<a href="http://www.national.com/switchers">www.national.com/switchers</a>		
LDOs	<a href="http://www.national.com/ldo">www.national.com/ldo</a>		
LED Lighting	<a href="http://www.national.com/led">www.national.com/led</a>		
PowerWise	<a href="http://www.national.com/powerwise">www.national.com/powerwise</a>		
Serial Digital Interface (SDI)	<a href="http://www.national.com/sdi">www.national.com/sdi</a>		
Temperature Sensors	<a href="http://www.national.com/tempsensors">www.national.com/tempsensors</a>		
Wireless (PLL/VCO)	<a href="http://www.national.com/wireless">www.national.com/wireless</a>		

THE CONTENTS OF THIS DOCUMENT ARE PROVIDED IN CONNECTION WITH NATIONAL SEMICONDUCTOR CORPORATION ("NATIONAL") PRODUCTS. NATIONAL MAKES NO REPRESENTATIONS OR WARRANTIES WITH RESPECT TO THE ACCURACY OR COMPLETENESS OF THE CONTENTS OF THIS PUBLICATION AND RESERVES THE RIGHT TO MAKE CHANGES TO SPECIFICATIONS AND PRODUCT DESCRIPTIONS AT ANY TIME WITHOUT NOTICE. NO LICENSE, WHETHER EXPRESS, IMPLIED, ARISING BY ESTOPPEL OR OTHERWISE, TO ANY INTELLECTUAL PROPERTY RIGHTS IS GRANTED BY THIS DOCUMENT.

TESTING AND OTHER QUALITY CONTROLS ARE USED TO THE EXTENT NATIONAL DEEMS NECESSARY TO SUPPORT NATIONAL'S PRODUCT WARRANTY. EXCEPT WHERE MANDATED BY GOVERNMENT REQUIREMENTS, TESTING OF ALL PARAMETERS OF EACH PRODUCT IS NOT NECESSARILY PERFORMED. NATIONAL ASSUMES NO LIABILITY FOR APPLICATIONS ASSISTANCE OR BUYER PRODUCT DESIGN. BUYERS ARE RESPONSIBLE FOR THEIR PRODUCTS AND APPLICATIONS USING NATIONAL COMPONENTS. PRIOR TO USING OR DISTRIBUTING ANY PRODUCTS THAT INCLUDE NATIONAL COMPONENTS, BUYERS SHOULD PROVIDE ADEQUATE DESIGN, TESTING AND OPERATING SAFEGUARDS.

EXCEPT AS PROVIDED IN NATIONAL'S TERMS AND CONDITIONS OF SALE FOR SUCH PRODUCTS, NATIONAL ASSUMES NO LIABILITY WHATSOEVER, AND NATIONAL DISCLAIMS ANY EXPRESS OR IMPLIED WARRANTY RELATING TO THE SALE AND/OR USE OF NATIONAL PRODUCTS INCLUDING LIABILITY OR WARRANTIES RELATING TO FITNESS FOR A PARTICULAR PURPOSE, MERCHANTABILITY, OR INFRINGEMENT OF ANY PATENT, COPYRIGHT OR OTHER INTELLECTUAL PROPERTY RIGHT.

### LIFE SUPPORT POLICY

**NATIONAL'S PRODUCTS ARE NOT AUTHORIZED FOR USE AS CRITICAL COMPONENTS IN LIFE SUPPORT DEVICES OR SYSTEMS WITHOUT THE EXPRESS PRIOR WRITTEN APPROVAL OF THE CHIEF EXECUTIVE OFFICER AND GENERAL COUNSEL OF NATIONAL SEMICONDUCTOR CORPORATION.** As used herein:

Life support devices or systems are devices which (a) are intended for surgical implant into the body, or (b) support or sustain life and whose failure to perform when properly used in accordance with instructions for use provided in the labeling can be reasonably expected to result in a significant injury to the user. A critical component is any component in a life support device or system whose failure to perform can be reasonably expected to cause the failure of the life support device or system or to affect its safety or effectiveness.

National Semiconductor and the National Semiconductor logo are registered trademarks of National Semiconductor Corporation. All other brand or product names may be trademarks or registered trademarks of their respective holders.

Copyright© 2007 National Semiconductor Corporation

For the most current product information visit us at [www.national.com](http://www.national.com)



**National Semiconductor Americas Customer Support Center**  
 Email: [new.feedback@nsc.com](mailto:new.feedback@nsc.com)  
 Tel: 1-800-272-9959

**National Semiconductor Europe Customer Support Center**  
 Fax: +49 (0) 180-530-85-86  
 Email: [europe.support@nsc.com](mailto:europe.support@nsc.com)  
 Deutsch Tel: +49 (0) 69 9508 6208  
 English Tel: +49 (0) 870 24 0 2171  
 Français Tel: +33 (0) 1 41 91 8790

**National Semiconductor Asia Pacific Customer Support Center**  
 Email: [ap.support@nsc.com](mailto:ap.support@nsc.com)

**National Semiconductor Japan Customer Support Center**  
 Fax: 81-3-5639-7507  
 Email: [jpn.feedback@nsc.com](mailto:jpn.feedback@nsc.com)  
 Tel: 81-3-5639-7560