

NCP580

Ultra-Fast, Low Noise 120 mA CMOS LDO Regulator with Enable

The NCP580 series of low dropout regulators are designed for portable battery powered applications which require precise output voltage accuracy, low quiescent current, and high ripple rejection. These devices feature an enable function which lowers current consumption significantly and are offered in the small SC-82AB package.

A 2.2 μF ceramic capacitor or higher is the recommended value to be used with these devices on the output pin.

Features

- Ultra-Low Dropout Voltage of 150 mV at 100 mA
- Low Output Noise of 30 μV_{rms} without Noise Reduction Cap
- Excellent Line Regulation of 0.02%/V
- Excellent Load Regulation of 12 mV
- High Output Voltage Accuracy of $\pm 1.5\%$
- Low I_q Current of 90 μA
- Very Low Shutdown Current of 0.1 μA
- Excellent Power Supply Rejection Ratio of 70 dB at $f = 1.0$ kHz
- Wide Output Voltage Range of 1.5 V to 3.3 V
- Fold Back Protection Circuit
- Fast Dynamic Performance
- Low Temperature Drift Coefficient on the Output Voltage of ± 100 ppm/ $^{\circ}\text{C}$
- Input Voltage up to 6.5 V
- These are Pb-Free Devices

Typical Applications

- Portable Equipment
- Hand-Held Instrumentation
- Camcorders and Cameras

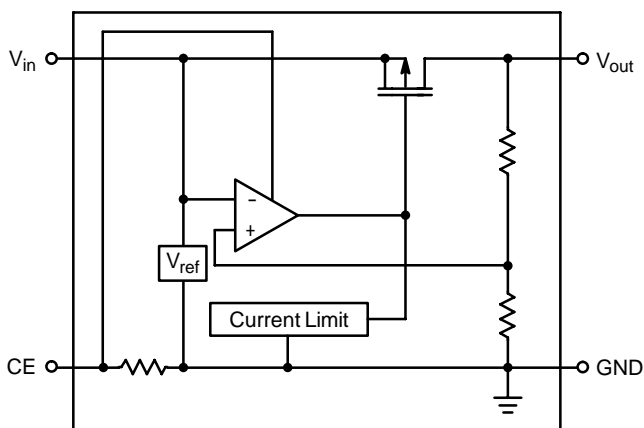
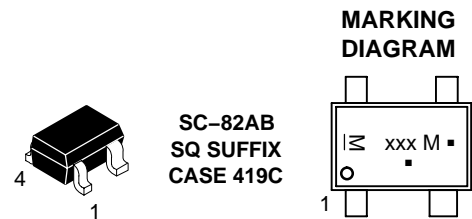

Figure 1. Simplified Block Diagram



ON Semiconductor®

<http://onsemi.com>



xxx = Device Code
M = Date Code*
▪ = Pb-Free Package

(Note: Microdot may be in either location)

*Date Code orientation and/or position may vary depending upon manufacturing location.

ORDERING INFORMATION

See detailed ordering and shipping information in the package dimensions section on page 8 of this data sheet.

NCP580

PIN FUNCTION DESCRIPTION

Pin	Symbol	Description
1	V_{out}	Regulated output voltage.
2	GND	Power supply ground.
3	CE	Chip enable pin.
4	V_{in}	Power supply input voltage.

MAXIMUM RATINGS

Rating	Symbol	Value	Unit
Input Voltage	V_{in}	6.5	V
Input Voltage (\overline{CE} or CE Pin)	V_{CE}	-0.3 to $V_{in} + 0.3$	V
Output Voltage	V_{out}	-0.3 to $V_{in} + 0.3$	V
Output Current	I_{out}	140	mA
Power Dissipation	P_D	150	mW
Operating Junction Temperature Range	T_J	-40 to +85	°C
Storage Temperature Range	T_{stg}	-55 to +150	°C

Stresses exceeding Maximum Ratings may damage the device. Maximum Ratings are stress ratings only. Functional operation above the Recommended Operating Conditions is not implied. Extended exposure to stresses above the Recommended Operating Conditions may affect device reliability.

ELECTRICAL CHARACTERISTICS ($V_{in} = V_{out} + 1.0$ V, $T_A = 25^\circ\text{C}$, unless otherwise noted.)

Characteristic	Symbol	Min	Typ	Max	Unit
Input Voltage	V_{in}	2.2	-	6.0	V
Output Voltage ($I_{out} = 1.0$ mA to 30 mA)	V_{out}	$V_{out} \times 0.985$	-	$V_{out} \times 1.015$	V
Line Regulation ($I_{out} = 30$ mA) ($V_{out} + 0.5$ V $\leq V_{in} \leq 6.0$ V) ($V_{out} = 1.5$ V, 2.2 V $\leq V_{in} \leq 6.0$ V)	Reg_{line}	-	0.02	0.10	%/V
Load Regulation ($I_{out} = 1.0$ mA to 120 mA)	Reg_{load}	-	12	40	mV
Dropout Voltage ($I_{out} = 120$ mA) $V_{out} = 1.5$ V $V_{out} = 1.8$ V $V_{out} = 2.5$ V 2.8 V $\leq V_{out} \leq 3.3$ V	V_{DO}	-	0.36 0.28 0.24 0.18	0.70 0.40 0.35 0.28	V
Quiescent Current ($I_{out} = 0$ mA)	I_q	-	90	160	μA
Output Current	I_{out}	120	-	-	mA
Shutdown Current ($V_{in} = V_{CE}$)	I_{SD}	-	0.1	1.0	μA
Output Short Circuit Current ($V_{out} = 0$)	I_{lim}	-	40	-	mA
Ripple Rejection ($I_{out} = 30$ mA) $f = 1.0$ kHz ($V_{out} = 1.5$ V, $V_{in} - V_{out} = 1.2$ V) ($V_{out} \geq 2.5$ V, $V_{in} - V_{out} = 1.0$ V)	RR	-	75 70	-	dB
Enable Input Threshold Voltage High Low	$V_{th_{enh}}$ $V_{th_{enl}}$	1.5 0	- -	V_{in} 0.3	V
Output Noise Voltage (Bandwidth = 10 Hz to 100 kHz)	V_n	-	30	-	μV_{rms}
Output Voltage Temperature Coefficient ($I_{out} = 30$ mA, $-40^\circ\text{C} \leq T_A \leq 85^\circ\text{C}$)	$\Delta V_{out}/\Delta T$	-	± 100	-	ppm/°C

TYPICAL CHARACTERISTICS

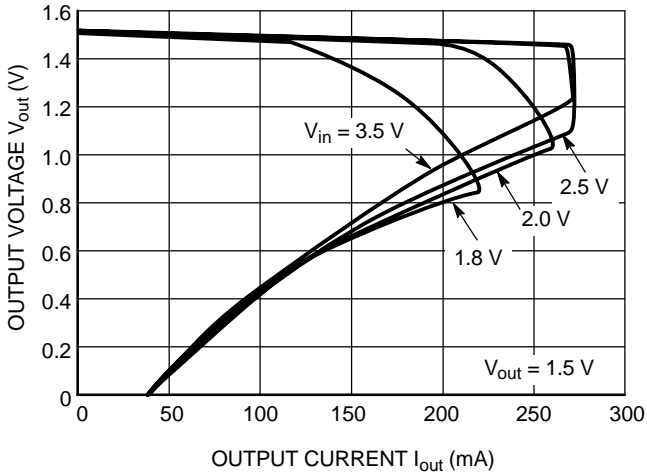

Figure 2. Output Voltage vs. Output Current

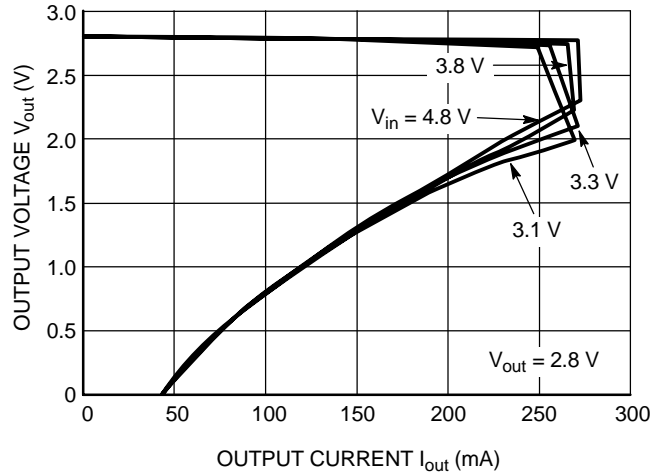

Figure 3. Output Voltage vs. Output Current

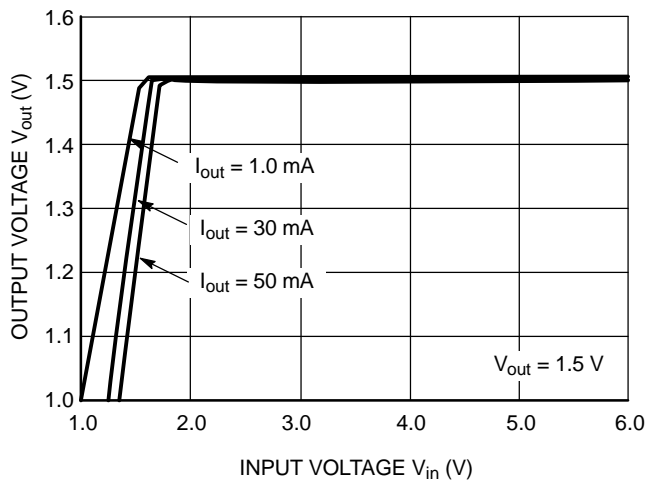

Figure 4. Output Voltage vs. Input Voltage

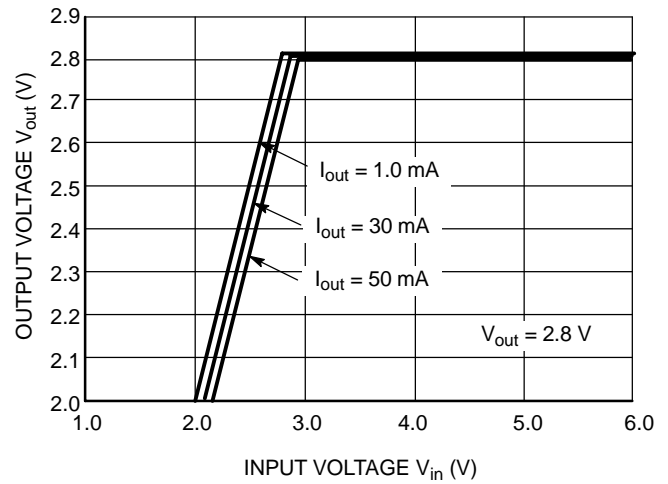

Figure 5. Output Voltage vs. Input Voltage

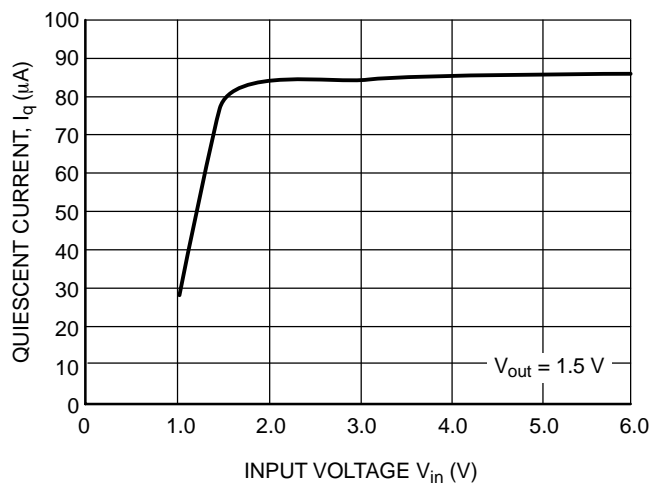

Figure 6. Quiescent Current vs. Input Voltage

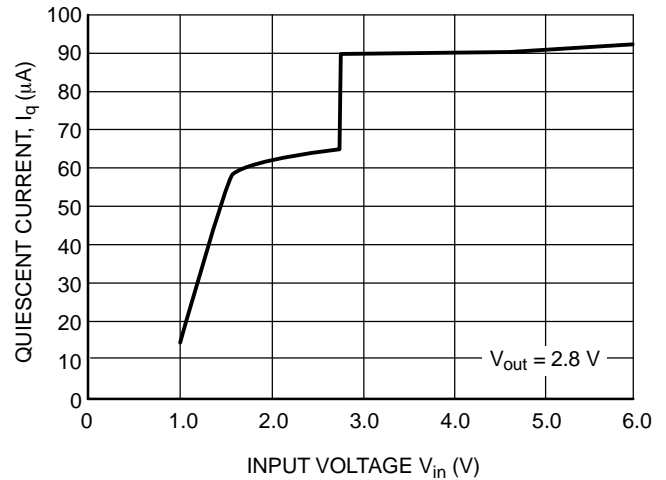

Figure 7. Quiescent Current vs. Input Voltage

NCP580

TYPICAL CHARACTERISTICS

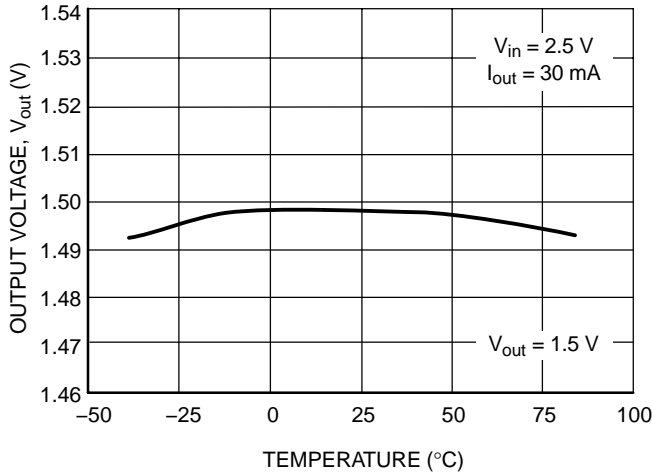

Figure 8. Output Voltage vs. Temperature

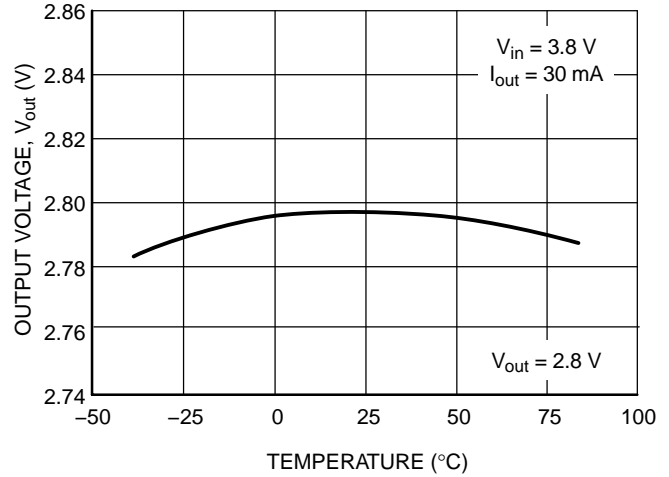

Figure 9. Output Voltage vs. Temperature

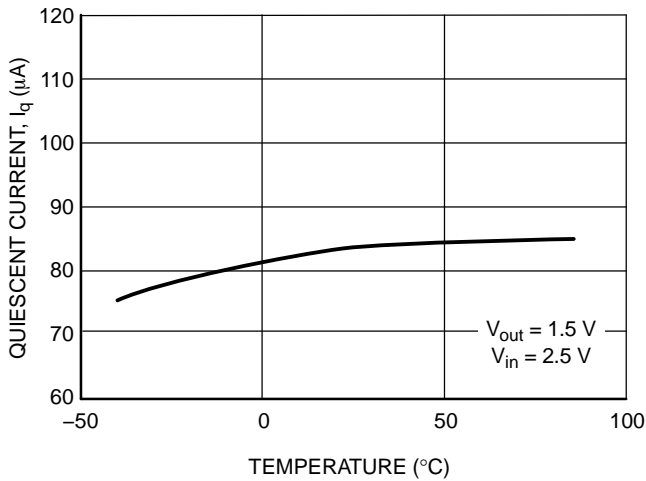

Figure 10. Quiescent Current vs. Temperature

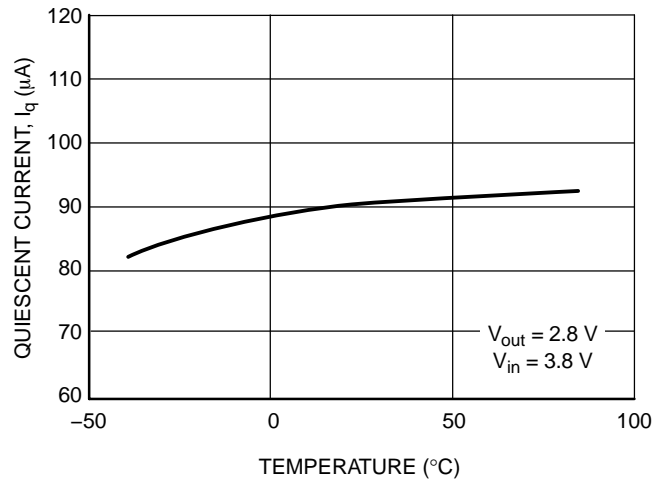

Figure 11. Quiescent Current vs. Temperature

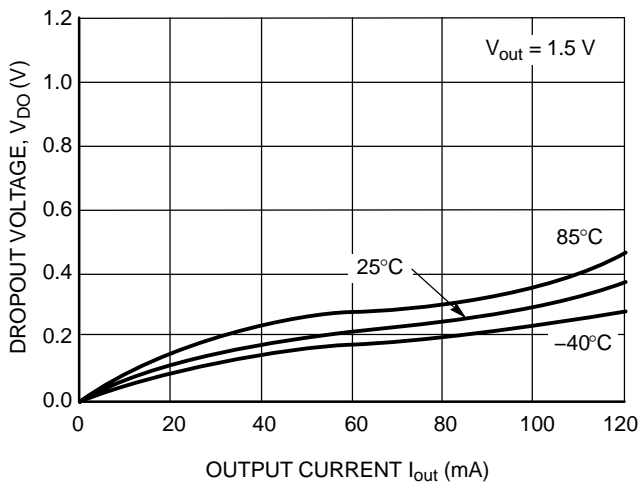

Figure 12. Dropout Voltage vs. Output Current

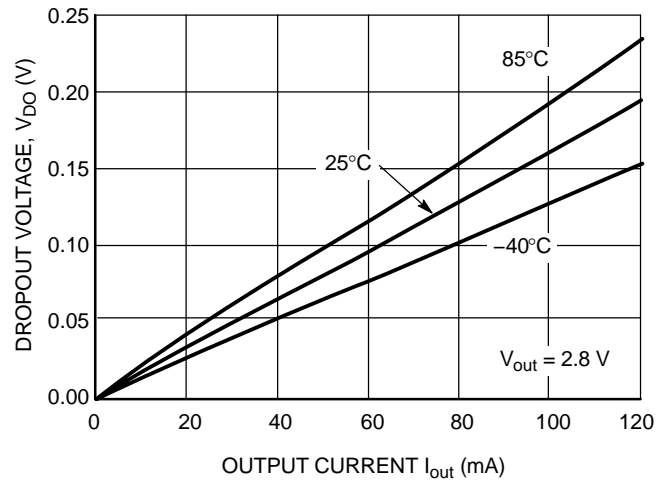

Figure 13. Dropout Voltage vs. Output Current

NCP580

TYPICAL CHARACTERISTICS

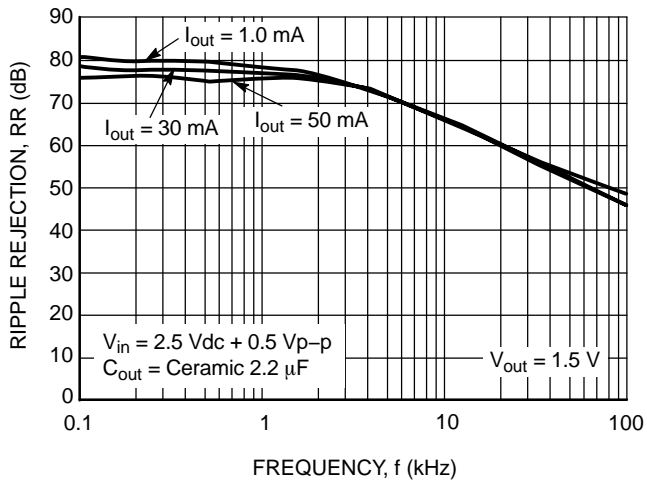

Figure 14. Ripple Rejection vs. Frequency

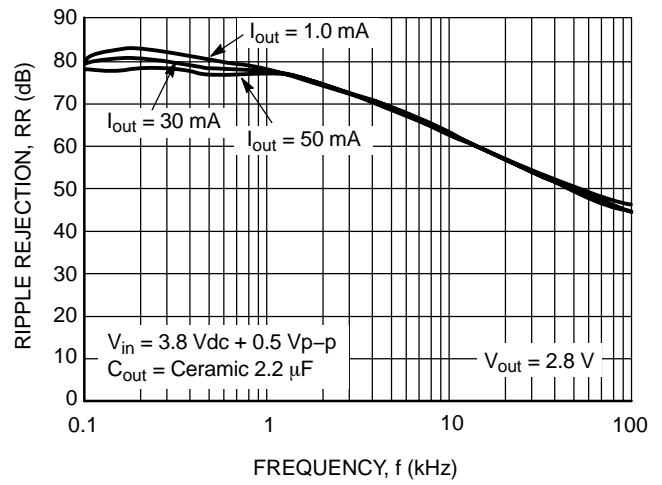

Figure 15. Ripple Rejection vs. Frequency

NCP580

TYPICAL CHARACTERISTICS

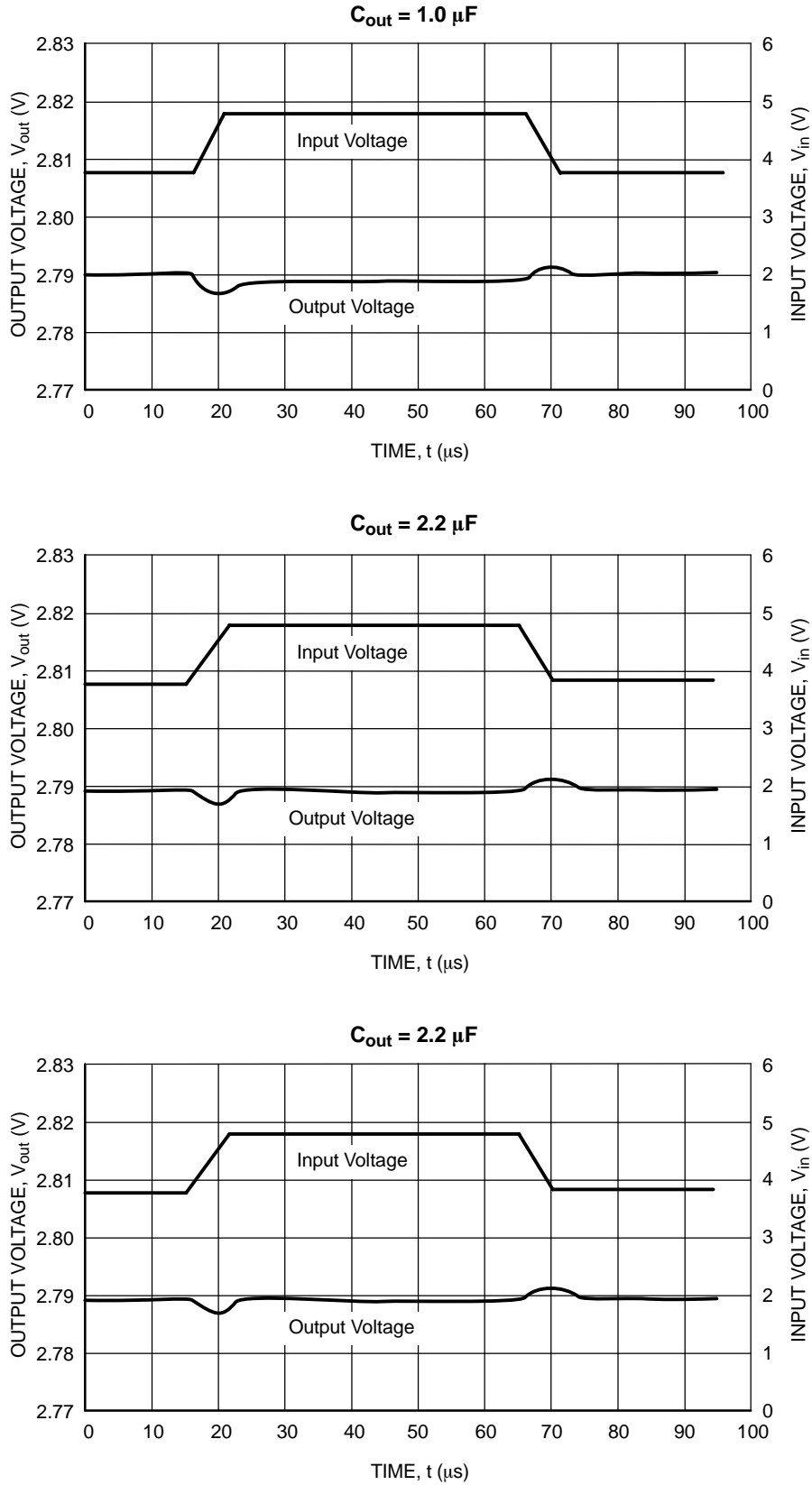

Figure 16. Input Transient Response
($V_{in} = 3.8 \text{ V to } 4.8 \text{ V}$, $I_{out} = 30 \text{ mA}$, $t_r = t_f = 5.0 \mu s$, $V_{out} = 2.8 \text{ V}$)

NCP580

TYPICAL CHARACTERISTICS

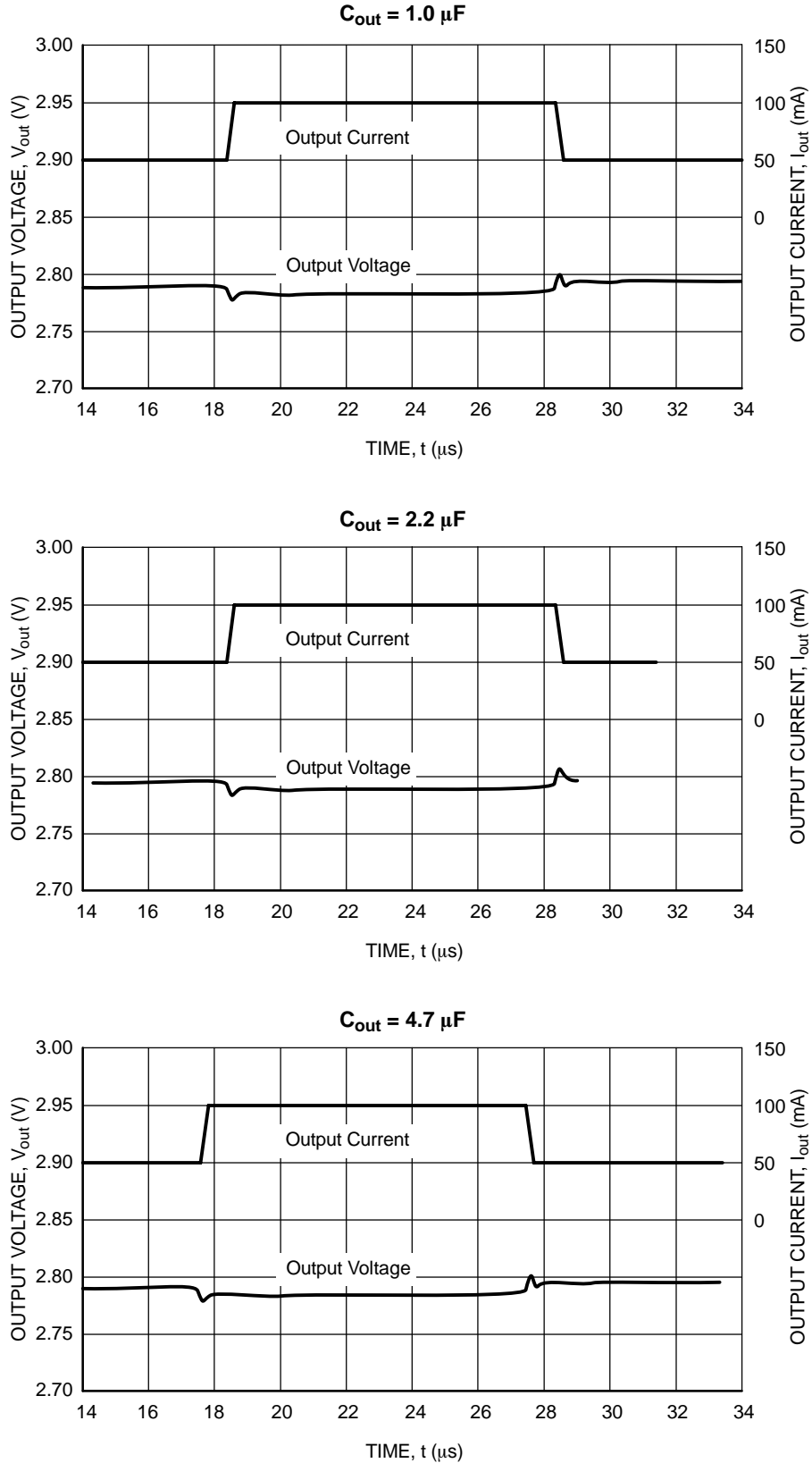

Figure 17. Load Transient Response
($V_{in} = 3.8 V$, $I_{out} = 50 mA$ to $100 mA$, $t_r = t_f = 5.0 \mu s$, $C_{in} = 1.0 \mu F$, $V_{out} = 2.8 V$)

NCP580

APPLICATION INFORMATION

Input Decoupling

A 1.0 μF ceramic capacitor is the recommended value to be connected between V_{in} and GND. For PCB layout considerations, the traces of V_{in} and GND should be sufficiently wide in order to minimize noise and prevent unstable operation.

Output Decoupling

It is best to use a 2.2 μF or higher capacitor value on the V_{out} pin. For better performance, select a capacitor with low Equivalent Series Resistance (ESR). For PCB layout considerations, place the output capacitor close to the output pin and keep the leads short as possible.

ORDERING INFORMATION

Device	Output Type / Features	Nominal Output Voltage	Marking	Package	Shipping†
NCP580SQ15T1G	Active High	1.5	AF	SC-82AB (Pb-Free)	3000 / Tape & Reel
NCP580SQ18T1G	Active High	1.8	AJ	SC-82AB (Pb-Free)	3000 / Tape & Reel
NCP580SQ25T1G	Active High	2.5	BF	SC-82AB (Pb-Free)	3000 / Tape & Reel
NCP580SQ28T1G	Active High	2.8	BJ	SC-82AB (Pb-Free)	3000 / Tape & Reel
NCP580SQ30T1G	Active High	3.0	CA	SC-82AB (Pb-Free)	3000 / Tape & Reel
NCP580SQ33T1G	Active High	3.3	CD	SC-82AB (Pb-Free)	3000 / Tape & Reel

†For information on tape and reel specifications, including part orientation and tape sizes, please refer to our Tape and Reel Packaging Specification Brochure, BRD8011/D.

Other voltages are available. Consult your ON Semiconductor representative.

NCP580

PACKAGE DIMENSIONS

SC-82AB
SQ SUFFIX
CASE 419C-02
ISSUE E

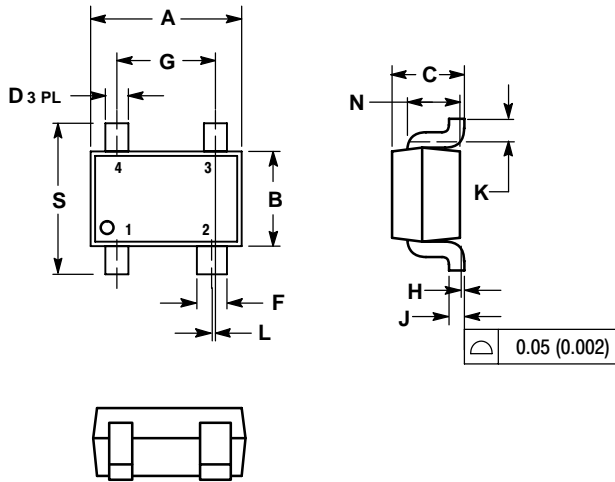

NOTES:

1. DIMENSIONING AND TOLERANCING PER ANSI Y14.5M, 1982.
2. CONTROLLING DIMENSION: MILLIMETER.
3. 419C-01 OBSOLETE. NEW STANDARD IS 419C-02.
4. DIMENSIONS A AND B DO NOT INCLUDE MOLD FLASH, PROTRUSIONS, OR GATE BURRS.

DIM	MILLIMETERS		INCHES	
	MIN	MAX	MIN	MAX
A	1.8	2.2	0.071	0.087
B	1.15	1.35	0.045	0.053
C	0.8	1.1	0.031	0.043
D	0.2	0.4	0.008	0.016
F	0.3	0.5	0.012	0.020
G	1.1	1.5	0.043	0.059
H	0.0	0.1	0.000	0.004
J	0.10	0.26	0.004	0.010
K	0.1	---	0.004	---
L	0.05 BSC		0.002 BSC	
N	0.2 REF		0.008 REF	
S	1.8	2.4	0.07	0.09

SOLDERING FOOTPRINT*

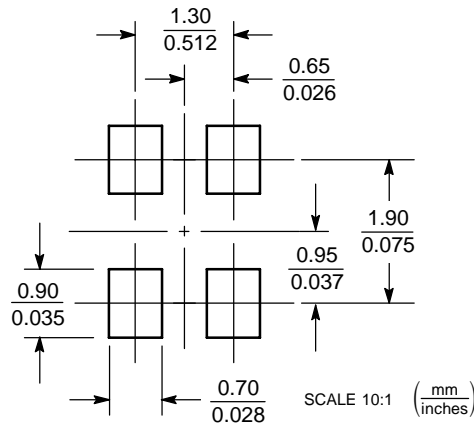

*For additional information on our Pb-Free strategy and soldering details, please download the ON Semiconductor Soldering and Mounting Techniques Reference Manual, SOLDERRM/D.

ON Semiconductor and are registered trademarks of Semiconductor Components Industries, LLC (SCILLC). SCILLC reserves the right to make changes without further notice to any products herein. SCILLC makes no warranty, representation or guarantee regarding the suitability of its products for any particular purpose, nor does SCILLC assume any liability arising out of the application or use of any product or circuit, and specifically disclaims any and all liability, including without limitation special, consequential or incidental damages. "Typical" parameters which may be provided in SCILLC data sheets and/or specifications can and do vary in different applications and actual performance may vary over time. All operating parameters, including "Typicals" must be validated for each customer application by customer's technical experts. SCILLC does not convey any license under its patent rights nor the rights of others. SCILLC products are not designed, intended, or authorized for use as components in systems intended for surgical implant into the body, or other applications intended to support or sustain life, or for any other application in which the failure of the SCILLC product could create a situation where personal injury or death may occur. Should Buyer purchase or use SCILLC products for any such unintended or unauthorized application, Buyer shall indemnify and hold SCILLC and its officers, employees, subsidiaries, affiliates, and distributors harmless against all claims, costs, damages, and expenses, and reasonable attorney fees arising out of, directly or indirectly, any claim of personal injury or death associated with such unintended or unauthorized use, even if such claim alleges that SCILLC was negligent regarding the design or manufacture of the part. SCILLC is an Equal Opportunity/Affirmative Action Employer. This literature is subject to all applicable copyright laws and is not for resale in any manner.

PUBLICATION ORDERING INFORMATION

LITERATURE FULFILLMENT:
Literature Distribution Center for ON Semiconductor
P.O. Box 5163, Denver, Colorado 80217 USA
Phone: 303-675-2175 or 800-344-3860 Toll Free USA/Canada
Fax: 303-675-2176 or 800-344-3867 Toll Free USA/Canada
Email: orderlit@onsemi.com

N. American Technical Support: 800-282-9855 Toll Free
USA/Canada
Europe, Middle East and Africa Technical Support:
Phone: 421 33 790 2910
Japan Customer Focus Center
Phone: 81-3-5773-3850

ON Semiconductor Website: www.onsemi.com

Order Literature: <http://www.onsemi.com/orderlit>

For additional information, please contact your local Sales Representative

NCP580/D