

LM1577/LM2577 Series SIMPLE SWITCHER® Step-Up Voltage Regulator

General Description

The LM1577/LM2577 are monolithic integrated circuits that provide all of the power and control functions for step-up (boost), flyback, and forward converter switching regulators. The device is available in three different output voltage versions: 12V, 15V, and adjustable.

Requiring a minimum number of external components, these regulators are cost effective, and simple to use. Listed in this data sheet are a family of standard inductors and flyback transformers designed to work with these switching regulators.

Included on the chip is a 3.0A NPN switch and its associated protection circuitry, consisting of current and thermal limiting, and undervoltage lockout. Other features include a 52 kHz fixed-frequency oscillator that requires no external components, a soft start mode to reduce in-rush current during start-up, and current mode control for improved rejection of input voltage and output load transients.

Features

- Requires few external components
- NPN output switches 3.0A, can stand off 65V
- Wide input voltage range: 3.5V to 40V
- Current-mode operation for improved transient response, line regulation, and current limit
- 52 kHz internal oscillator
- Soft-start function reduces in-rush current during start-up
- Output switch protected by current limit, under-voltage lockout, and thermal shutdown

Typical Applications

- Simple boost regulator
- Flyback and forward regulators
- Multiple-output regulator

Typical Application

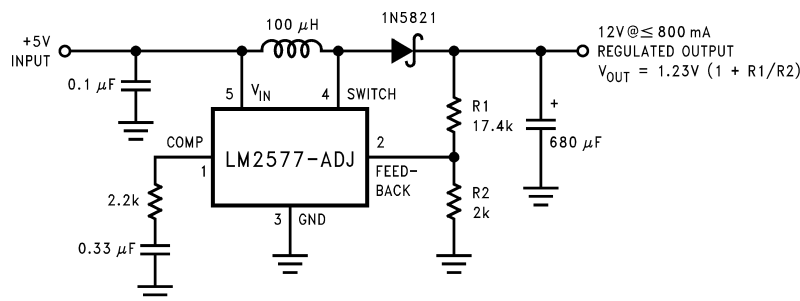

DS011468-1

Note: Pin numbers shown are for TO-220 (T) package.

Ordering Information

Temperature Range	Package Type	Output Voltage			NSC Package Drawing	Package
		12V	15V	ADJ		
-40°C ≤ T _A ≤ +125°C	24-Pin Surface Mount	LM2577M-12	LM2577M-15	LM2577M-ADJ	M24B	SO
	16-Pin Molded DIP	LM2577N-12	LM2577N-15	LM2577N-ADJ	N16A	N
	5-Lead Surface Mount	LM2577S-12	LM2577S-15	LM2577S-ADJ	TS5B	TO-263
	5-Straight Leads	LM2577T-12	LM2577T-15	LM2577T-ADJ	T05A	TO-220
	5-Bent Staggered Leads	LM2577T-12 Flow LB03	LM2577T-15 Flow LB03	LM2577T-ADJ Flow LB03	T05D	TO-220
-55°C ≤ T _A ≤ +150°C	4-Pin TO-3	LM1577K-12/883	LM1577K-15/883	LM1577K-ADJ/883	K04A	TO-3

SIMPLE SWITCHER® is a registered trademark of National Semiconductor Corporation.

Absolute Maximum Ratings (Note 1)

If Military/Aerospace specified devices are required, please contact the National Semiconductor Sales Office/Distributors for availability and specifications.

Supply Voltage	45V
Output Switch Voltage	65V
Output Switch Current (Note 2)	6.0A
Power Dissipation	Internally Limited
Storage Temperature Range	-65°C to +150°C
Lead Temperature (Soldering, 10 sec.)	260°C
Maximum Junction Temperature	150°C

Minimum ESD Rating

(C = 100 pF, R = 1.5 kΩ)

2 kV

Operating Ratings

Supply Voltage	$3.5V \leq V_{IN} \leq 40V$
Output Switch Voltage	$0V \leq V_{SWITCH} \leq 60V$
Output Switch Current	$I_{SWITCH} \leq 3.0A$
Junction Temperature Range	
LM1577	$-55^\circ C \leq T_J \leq +150^\circ C$
LM2577	$-40^\circ C \leq T_J \leq +125^\circ C$

Electrical Characteristics—LM1577-12, LM2577-12

Specifications with standard type face are for $T_J = 25^\circ C$, and those in **bold type face** apply over full **Operating Temperature Range**. Unless otherwise specified, $V_{IN} = 5V$, and $I_{SWITCH} = 0$.

Symbol	Parameter	Conditions	Typical	LM1577-12 Limit (Notes 3, 4)	LM2577-12 Limit (Note 5)	Units (Limits)
SYSTEM PARAMETERS Circuit of Figure 1 (Note 6)						
V_{OUT}	Output Voltage	$V_{IN} = 5V$ to 10V $I_{LOAD} = 100$ mA to 800 mA (Note 3)	12.0	11.60/ 11.40 12.40/ 12.60	11.60/ 11.40 12.40/ 12.60	V V(min) V(max)
$\frac{\Delta V_{OUT}}{\Delta V_{IN}}$	Line Regulation	$V_{IN} = 3.5V$ to 10V $I_{LOAD} = 300$ mA	20	50/100	50/100	mV mV(max)
$\frac{\Delta V_{OUT}}{\Delta I_{LOAD}}$	Load Regulation	$V_{IN} = 5V$ $I_{LOAD} = 100$ mA to 800 mA	20	50/100	50/100	mV mV(max)
η	Efficiency	$V_{IN} = 5V$, $I_{LOAD} = 800$ mA	80			%
DEVICE PARAMETERS						
I_S	Input Supply Current	$V_{FEEDBACK} = 14V$ (Switch Off)	7.5	10.0/14.0	10.0/14.0	mA mA(max)
		$I_{SWITCH} = 2.0A$ $V_{COMP} = 2.0V$ (Max Duty Cycle)	25	50/85	50/85	mA mA(max)
V_{UV}	Input Supply Undervoltage Lockout	$I_{SWITCH} = 100$ mA	2.90	2.70/ 2.65 3.10/ 3.15	2.70/ 2.65 3.10/ 3.15	V V(min) V(max)
f_O	Oscillator Frequency	Measured at Switch Pin $I_{SWITCH} = 100$ mA	52	48/42 56/62	48/42 56/62	kHz kHz(min) kHz(max)
V_{REF}	Output Reference Voltage	Measured at Feedback Pin $V_{IN} = 3.5V$ to 40V $V_{COMP} = 1.0V$	12	11.76/ 11.64 12.24/ 12.36	11.76/ 11.64 12.24/ 12.36	V V(min) V(max)
$\frac{\Delta V_{REF}}{\Delta V_{IN}}$	Output Reference Voltage Line Regulator	$V_{IN} = 3.5V$ to 40V	7			mV
R_{FB}	Feedback Pin Input Resistance		9.7			kΩ
G_M	Error Amp Transconductance	$I_{COMP} = -30$ μA to +30 μA $V_{COMP} = 1.0V$	370	225/ 145 515/ 615	225/ 145 515/ 615	μmho μmho(min) μmho(max)
A_{VOL}	Error Amp Voltage Gain	$V_{COMP} = 1.1V$ to 1.9V $R_{COMP} = 1.0$ MΩ (Note 7)	80	50/25	50/25	V/V V/V(min)

Electrical Characteristics—LM1577-12, LM2577-12 (Continued)

Specifications with standard type face are for $T_J = 25^\circ\text{C}$, and those in **bold type face** apply over full **Operating Temperature Range**. Unless otherwise specified, $V_{IN} = 5\text{V}$, and $I_{SWITCH} = 0$.

Symbol	Parameter	Conditions	Typical	LM1577-12 Limit (Notes 3, 4)	LM2577-12 Limit (Note 5)	Units (Limits)
DEVICE PARAMETERS						
	Error Amplifier Output Swing	Upper Limit $V_{FEEDBACK} = 10.0\text{V}$	2.4	2.2/ 2.0	2.2/ 2.0	V V(min)
		Lower Limit $V_{FEEDBACK} = 15.0\text{V}$	0.3	0.40/ 0.55	0.40/ 0.55	V V(max)
	Error Amplifier Output Current	$V_{FEEDBACK} = 10.0\text{V}$ to 15.0V $V_{COMP} = 1.0\text{V}$	± 200	± 130 / ± 90 ± 300/± 400	± 130 / ± 90 ± 300/± 400	μA $\mu\text{A}(\text{min})$ $\mu\text{A}(\text{max})$
I_{SS}	Soft Start Current	$V_{FEEDBACK} = 10.0\text{V}$ $V_{COMP} = 0\text{V}$	5.0	2.5/ 1.5 7.5/ 9.5	2.5/ 1.5 7.5/ 9.5	μA $\mu\text{A}(\text{min})$ $\mu\text{A}(\text{max})$
D	Maximum Duty Cycle	$V_{COMP} = 1.5\text{V}$ $I_{SWITCH} = 100\text{ mA}$	95	93/ 90	93/ 90	% %(min)
$\frac{\Delta I_{SWITCH}}{\Delta V_{COMP}}$	Switch Transconductance		12.5			A/V
I_L	Switch Leakage Current	$V_{SWITCH} = 65\text{V}$ $V_{FEEDBACK} = 15\text{V}$ (Switch Off)	10	300/ 600	300/ 600	μA $\mu\text{A}(\text{max})$
V_{SAT}	Switch Saturation Voltage	$I_{SWITCH} = 2.0\text{A}$ $V_{COMP} = 2.0\text{V}$ (Max Duty Cycle)	0.5	0.7/ 0.9	0.7/ 0.9	V V(max)
	NPN Switch Current Limit		4.5	3.7/ 3.0 5.3/ 6.0	3.7/ 3.0 5.3/ 6.0	A A(min) A(max)

Electrical Characteristics—LM1577-15, LM2577-15

Specifications with standard type face are for $T_J = 25^\circ\text{C}$, and those in **bold type face** apply over full **Operating Temperature Range**. Unless otherwise specified, $V_{IN} = 5\text{V}$, and $I_{SWITCH} = 0$.

Symbol	Parameter	Conditions	Typical	LM1577-15 Limit (Notes 3, 4)	LM2577-15 Limit (Note 5)	Units (Limits)
SYSTEM PARAMETERS Circuit of <i>Figure 2</i> (Note 6)						
V_{OUT}	Output Voltage	$V_{IN} = 5\text{V}$ to 12V $I_{LOAD} = 100\text{ mA}$ to 600 mA (Note 3)	15.0	14.50/ 14.25 15.50/ 15.75	14.50/ 14.25 15.50/ 15.75	V V(min) V(max)
$\frac{\Delta V_{OUT}}{\Delta V_{IN}}$	Line Regulation	$V_{IN} = 3.5\text{V}$ to 12V $I_{LOAD} = 300\text{ mA}$	20	50/ 100	50/ 100	mV mV(max)
$\frac{\Delta V_{OUT}}{\Delta I_{LOAD}}$	Load Regulation	$V_{IN} = 5\text{V}$ $I_{LOAD} = 100\text{ mA}$ to 600 mA	20	50/ 100	50/ 100	mV mV(max)
η	Efficiency	$V_{IN} = 5\text{V}$, $I_{LOAD} = 600\text{ mA}$	80			%
DEVICE PARAMETERS						
I_S	Input Supply Current	$V_{FEEDBACK} = 18.0\text{V}$ (Switch Off)	7.5	10.0/ 14.0	10.0/ 14.0	mA mA(max)
		$I_{SWITCH} = 2.0\text{A}$ $V_{COMP} = 2.0\text{V}$ (Max Duty Cycle)	25	50/ 85	50/ 85	mA mA(max)
V_{UV}	Input Supply	$I_{SWITCH} = 100\text{ mA}$	2.90			V

Electrical Characteristics—LM1577-15, LM2577-15 (Continued)

Specifications with standard type face are for $T_J = 25^\circ\text{C}$, and those in **bold type face** apply over full **Operating Temperature Range**. Unless otherwise specified, $V_{IN} = 5\text{V}$, and $I_{SWITCH} = 0$.

Symbol	Parameter	Conditions	Typical	LM1577-15 Limit (Notes 3, 4)	LM2577-15 Limit (Note 5)	Units (Limits)
DEVICE PARAMETERS						
	Undervoltage Lockout			2.70/ 2.65 3.10/ 3.15	2.70/ 2.65 3.10/ 3.15	V(min) V(max)
f_O	Oscillator Frequency	Measured at Switch Pin $I_{SWITCH} = 100\text{ mA}$	52	48/42 56/62	48/42 56/62	kHz kHz(min) kHz(max)
V_{REF}	Output Reference Voltage	Measured at Feedback Pin $V_{IN} = 3.5\text{V to }40\text{V}$ $V_{COMP} = 1.0\text{V}$	15	14.70/ 14.55 15.30/ 15.45	14.70/ 14.55 15.30/ 15.45	V V(min) V(max)
$\frac{\Delta V_{REF}}{\Delta V_{IN}}$	Output Reference Voltage Line Regulation	$V_{IN} = 3.5\text{V to }40\text{V}$	10			mV
R_{FB}	Feedback Pin Input Voltage Line Regulator		12.2			k Ω
G_M	Error Amp Transconductance	$I_{COMP} = -30\text{ }\mu\text{A to }+30\text{ }\mu\text{A}$ $V_{COMP} = 1.0\text{V}$	300	170/ 110 420/ 500	170/ 110 420/ 500	μmho $\mu\text{mho(min)}$ $\mu\text{mho(max)}$
A_{VOL}	Error Amp Voltage Gain	$V_{COMP} = 1.1\text{V to }1.9\text{V}$ $R_{COMP} = 1.0\text{ M}\Omega$ (Note 7)	65	40/20	40/20	V/V V/V(min)
	Error Amplifier Output Swing	Upper Limit $V_{FEEDBACK} = 12.0\text{V}$	2.4	2.2/2.0	2.2/2.0	V V(min)
		Lower Limit $V_{FEEDBACK} = 18.0\text{V}$	0.3	0.4/0.55	0.40/0.55	V V(max)
	Error Amp Output Current	$V_{FEEDBACK} = 12.0\text{V to }18.0\text{V}$ $V_{COMP} = 1.0\text{V}$	± 200	$\pm 130/\pm 90$ $\pm 300/\pm 400$	$\pm 130/\pm 90$ $\pm 300/\pm 400$	μA $\mu\text{A(min)}$ $\mu\text{A(max)}$
I_{SS}	Soft Start Current	$V_{FEEDBACK} = 12.0\text{V}$ $V_{COMP} = 0\text{V}$	5.0	2.5/ 1.5 7.5/ 9.5	2.5/ 1.5 7.5/ 9.5	μA $\mu\text{A(min)}$ $\mu\text{A(max)}$
D	Maximum Duty Cycle	$V_{COMP} = 1.5\text{V}$ $I_{SWITCH} = 100\text{ mA}$	95	93/90	93/90	% %(min)
$\frac{\Delta I_{SWITCH}}{\Delta V_{COMP}}$	Switch Transconductance		12.5			A/V
I_L	Switch Leakage Current	$V_{SWITCH} = 65\text{V}$ $V_{FEEDBACK} = 18.0\text{V}$ (Switch Off)	10	300/ 600	300/ 600	μA $\mu\text{A(max)}$
V_{SAT}	Switch Saturation Voltage	$I_{SWITCH} = 2.0\text{A}$ $V_{COMP} = 2.0\text{V}$ (Max Duty Cycle)	0.5	0.7/0.9	0.7/0.9	V V(max)
	NPN Switch Current Limit	$V_{COMP} = 2.0\text{V}$	4.3	3.7/3.0 5.3/6.0	3.7/3.0 5.3/6.0	A A(min) A(max)

Electrical Characteristics—LM1577-ADJ, LM2577-ADJ

Specifications with standard type face are for $T_J = 25^\circ\text{C}$, and those in **bold type face** apply over full **Operating Temperature Range**. Unless otherwise specified, $V_{IN} = 5\text{V}$, $V_{FEEDBACK} = V_{REF}$, and $I_{SWITCH} = 0$.

Symbol	Parameter	Conditions	Typical	LM1577-ADJ Limit (Notes 3, 4)	LM2577-ADJ Limit (Note 5)	Units (Limits)
SYSTEM PARAMETERS Circuit of <i>Figure 3</i> (Note 6)						
V_{OUT}	Output Voltage	$V_{IN} = 5\text{V to }10\text{V}$ $I_{LOAD} = 100\text{ mA to }800\text{ mA}$ (Note 3)	12.0	11.60/ 11.40 12.40/ 12.60	11.60/ 11.40 12.40/ 12.60	V V(min) V(max)
$\Delta V_{OUT}/\Delta V_{IN}$	Line Regulation	$V_{IN} = 3.5\text{V to }10\text{V}$ $I_{LOAD} = 300\text{ mA}$	20	50/ 100	50/ 100	mV mV(max)
$\Delta V_{OUT}/\Delta I_{LOAD}$	Load Regulation	$V_{IN} = 5\text{V}$ $I_{LOAD} = 100\text{ mA to }800\text{ mA}$	20	50/ 100	50/ 100	mV mV(max)
η	Efficiency	$V_{IN} = 5\text{V}$, $I_{LOAD} = 800\text{ mA}$	80			%
DEVICE PARAMETERS						
I_S	Input Supply Current	$V_{FEEDBACK} = 1.5\text{V}$ (Switch Off)	7.5	10.0/ 14.0	10.0/ 14.0	mA mA(max)
		$I_{SWITCH} = 2.0\text{A}$ $V_{COMP} = 2.0\text{V}$ (Max Duty Cycle)	25	50/ 85	50/ 85	mA mA(max)
V_{UV}	Input Supply Undervoltage Lockout	$I_{SWITCH} = 100\text{ mA}$	2.90	2.70/ 2.65 3.10/ 3.15	2.70/ 2.65 3.10/ 3.15	V V(min) V(max)
f_O	Oscillator Frequency	Measured at Switch Pin $I_{SWITCH} = 100\text{ mA}$	52	48/ 42 56/ 62	48/ 42 56/ 62	kHz kHz(min) kHz(max)
V_{REF}	Reference Voltage	Measured at Feedback Pin $V_{IN} = 3.5\text{V to }40\text{V}$ $V_{COMP} = 1.0\text{V}$	1.230	1.214/ 1.206 1.246/ 1.254	1.214/ 1.206 1.246/ 1.254	V V(min) V(max)
$\Delta V_{REF}/\Delta V_{IN}$	Reference Voltage Line Regulation	$V_{IN} = 3.5\text{V to }40\text{V}$	0.5			mV
I_B	Error Amp Input Bias Current	$V_{COMP} = 1.0\text{V}$	100	300/ 800	300/ 800	nA nA(max)
G_M	Error Amp Transconductance	$I_{COMP} = -30\text{ }\mu\text{A to }+30\text{ }\mu\text{A}$ $V_{COMP} = 1.0\text{V}$	3700	2400/ 1600 4800/ 5800	2400/ 1600 4800/ 5800	μmho $\mu\text{mho}(\text{min})$ $\mu\text{mho}(\text{max})$
A_{VOL}	Error Amp Voltage Gain	$V_{COMP} = 1.1\text{V to }1.9\text{V}$ $R_{COMP} = 1.0\text{ M}\Omega$ (Note 7)	800	500/ 250	500/ 250	V/V V/V(min)
	Error Amplifier Output Swing	Upper Limit $V_{FEEDBACK} = 1.0\text{V}$	2.4	2.2/ 2.0	2.2/ 2.0	V V(min)
		Lower Limit $V_{FEEDBACK} = 1.5\text{V}$	0.3	0.40/ 0.55	0.40/ 0.55	V V(max)
	Error Amp Output Current	$V_{FEEDBACK} = 1.0\text{V to }1.5\text{V}$ $V_{COMP} = 1.0\text{V}$	± 200	$\pm 130/\pm 90$ $\pm 300/\pm 400$	$\pm 130/\pm 90$ $\pm 300/\pm 400$	μA $\mu\text{A}(\text{min})$ $\mu\text{A}(\text{max})$
I_{SS}	Soft Start Current	$V_{FEEDBACK} = 1.0\text{V}$ $V_{COMP} = 0\text{V}$	5.0	2.5/ 1.5 7.5/ 9.5	2.5/ 1.5 7.5/ 9.5	μA $\mu\text{A}(\text{min})$ $\mu\text{A}(\text{max})$
D	Maximum Duty Cycle	$V_{COMP} = 1.5\text{V}$ $I_{SWITCH} = 100\text{ mA}$	95	93/ 90	93/ 90	% %(min)
$\Delta I_{SWITCH}/\Delta V_{COMP}$	Switch Transconductance		12.5			A/V

Electrical Characteristics—LM1577-ADJ, LM2577-ADJ (Continued)

Specifications with standard type face are for $T_J = 25^\circ\text{C}$, and those in **bold type face** apply over full **Operating Temperature Range**. Unless otherwise specified, $V_{IN} = 5\text{V}$, $V_{FEEDBACK} = V_{REF}$, and $I_{SWITCH} = 0$.

Symbol	Parameter	Conditions	Typical	LM1577-ADJ Limit (Notes 3, 4)	LM2577-ADJ Limit (Note 5)	Units (Limits)
DEVICE PARAMETERS						
I_L	Switch Leakage Current	$V_{SWITCH} = 65\text{V}$ $V_{FEEDBACK} = 1.5\text{V}$ (Switch Off)	10	300/ 600	300/ 600	μA $\mu\text{A}(\text{max})$
V_{SAT}	Switch Saturation Voltage	$I_{SWITCH} = 2.0\text{A}$ $V_{COMP} = 2.0\text{V}$ (Max Duty Cycle)	0.5	0.7/ 0.9	0.7/ 0.9	V V(max)
	NPN Switch Current Limit	$V_{COMP} = 2.0\text{V}$	4.3	3.7/ 3.0 5.3/ 6.0	3.7/ 3.0 5.3/ 6.0	A A(min) A(max)
THERMAL PARAMETERS (All Versions)						
θ_{JA}	Thermal Resistance	K Package, Junction to Ambient	35			$^\circ\text{C/W}$
θ_{JC}		K Package, Junction to Case	1.5			
θ_{JA}		T Package, Junction to Ambient	65			
θ_{JC}		T Package, Junction to Case	2			
θ_{JA}		N Package, Junction to Ambient (Note 8)	85			
θ_{JA}		M Package, Junction to Ambient (Note 8)	100			
θ_{JA}		S Package, Junction to Ambient (Note 9)	37			

Note 1: Absolute Maximum Ratings indicate limits beyond which damage to the device may occur. Operating ratings indicate conditions the device is intended to be functional, but device parameter specifications may not be guaranteed under these conditions. For guaranteed specifications and test conditions, see the Electrical Characteristics.

Note 2: Due to timing considerations of the LM1577/LM2577 current limit circuit, output current cannot be internally limited when the LM1577/LM2577 is used as a step-up regulator. To prevent damage to the switch, its current must be externally limited to 6.0A. However, output current is internally limited when the LM1577/LM2577 is used as a flyback or forward converter regulator in accordance to the Application Hints.

Note 3: All limits guaranteed at room temperature (standard type face) and at temperature extremes (boldface type). All limits are used to calculate Outgoing Quality Level, and are 100% production tested.

Note 4: A military RETS electrical test specification is available on request. At the time of printing, the LM1577K-12/883, LM1577K-15/883, and LM1577K-ADJ/883 RETS specifications complied fully with the boldface limits in these columns. The LM1577K-12/883, LM1577K-15/883, and LM1577K-ADJ/883 may also be procured to Standard Military Drawing specifications.

Note 5: All limits guaranteed at room temperature (standard type face) and at temperature extremes (boldface type). All room temperature limits are 100% production tested. All limits at temperature extremes are guaranteed via correlation using standard Statistical Quality Control (SQC) methods.

Note 6: External components such as the diode, inductor, input and output capacitors can affect switching regulator performance. When the LM1577/LM2577 is used as shown in the Test Circuit, system performance will be as specified by the system parameters.

Note 7: A 1.0 M Ω resistor is connected to the compensation pin (which is the error amplifier's output) to ensure accuracy in measuring A_{VOL} . In actual applications, this pin's load resistance should be $\geq 10\text{M}\Omega$, resulting in A_{VOL} that is typically twice the guaranteed minimum limit.

Note 8: Junction to ambient thermal resistance with approximately 1 square inch of pc board copper surrounding the leads. Additional copper area will lower thermal resistance further. See thermal model in "Switchers Made Simple" software.

Note 9: If the TO-263 package is used, the thermal resistance can be reduced by increasing the PC board copper area thermally connected to the package. Using 0.5 square inches of copper area, θ_{JA} is 50 $^\circ\text{C/W}$; with 1 square inch of copper area, θ_{JA} is 37 $^\circ\text{C/W}$; and with 1.6 or more square inches of copper area, θ_{JA} is 32 $^\circ\text{C/W}$.

Typical Performance Characteristics

Reference Voltage vs Temperature

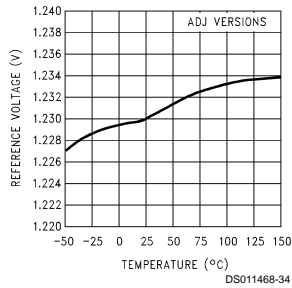

Reference Voltage vs Temperature

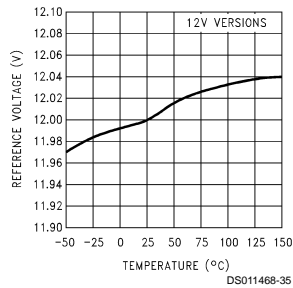

Reference Voltage vs Temperature

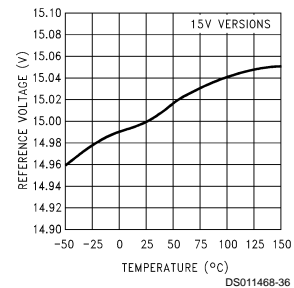

Δ Reference Voltage vs Supply Voltage

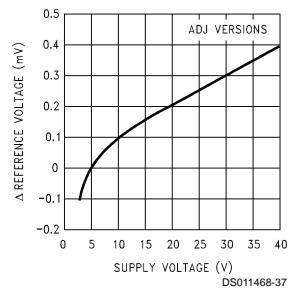

Δ Reference Voltage vs Supply Voltage

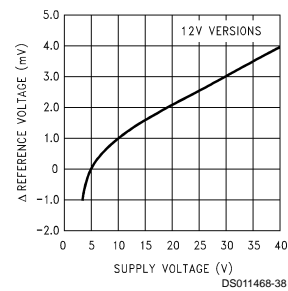

Δ Reference Voltage vs Supply Voltage

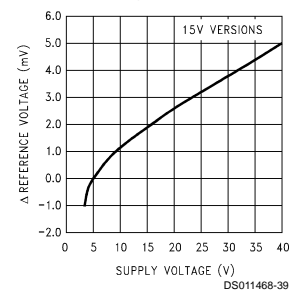

Error Amp Transconductance vs Temperature

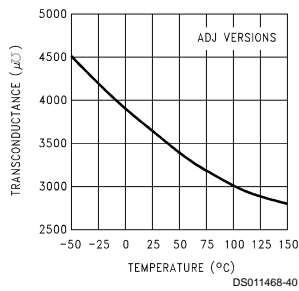

Error Amp Transconductance vs Temperature

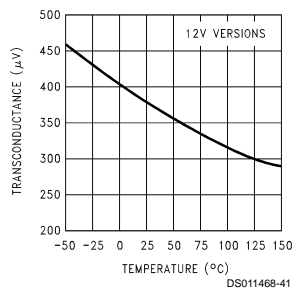

Error Amp Transconductance vs Temperature

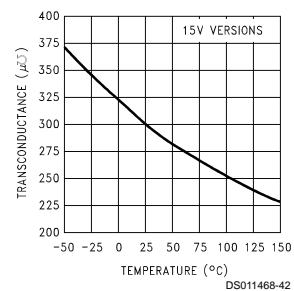

Typical Performance Characteristics (Continued)

Error Amp Voltage Gain vs Temperature

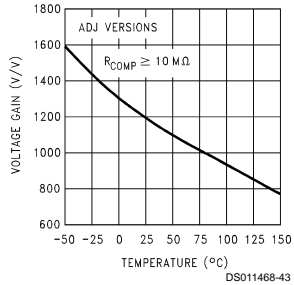

Error Amp Voltage Gain vs Temperature

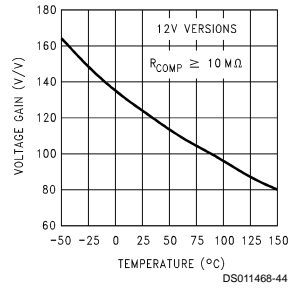

Error Amp Voltage Gain vs Temperature

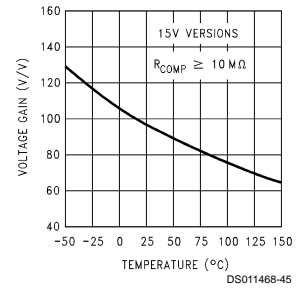

Quiescent Current vs Temperature

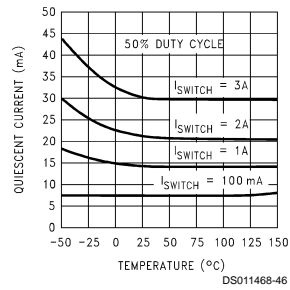

Quiescent Current vs Switch Current

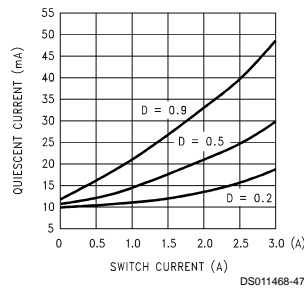

Current Limit vs Temperature

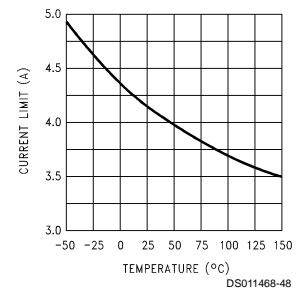

Current Limit Response Time vs Overdrive

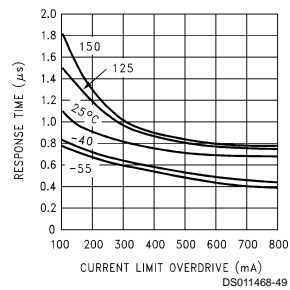

Switch Saturation Voltage vs Switch Current

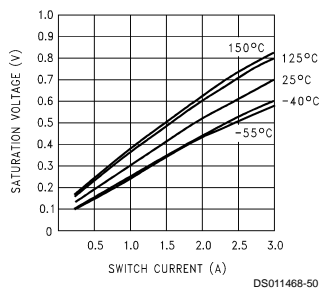

Switch Transconductance vs Temperature

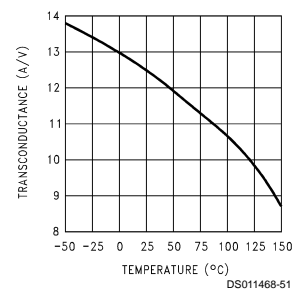

Typical Performance Characteristics (Continued)

Feedback Pin Bias Current vs Temperature

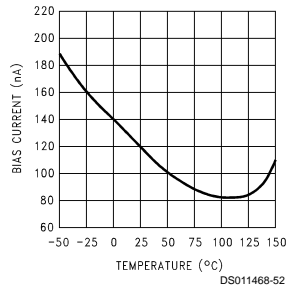

Oscillator Frequency vs Temperature

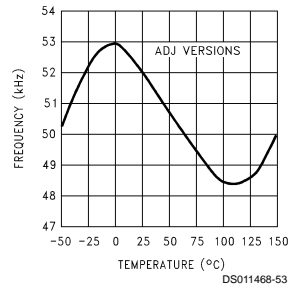

Maximum Power Dissipation (TO-263) (Note 9)

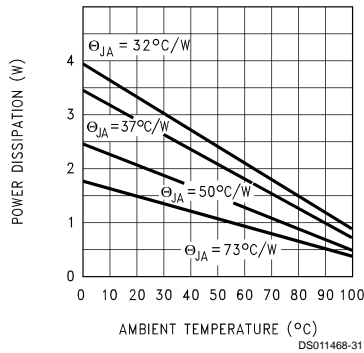

Connection Diagrams

**Straight Leads
5-Lead TO-220 (T)**

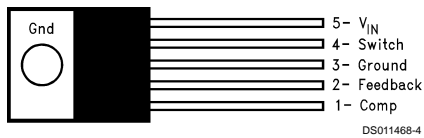

Top View
Order Number LM2577T-12, LM2577T-15,
or LM2577T-ADJ
See NS Package Number T05A

**Bent, Staggered Leads
5-Lead TO-220 (T)**

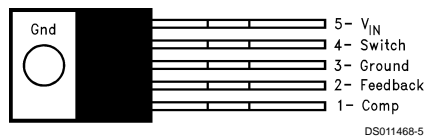

Top View
Order Number LM2577T-12 Flow LB03, LM2577T-15
Flow LB03, or LM2577T-ADJ Flow LB03
See NS Package Number T05D

Connection Diagrams (Continued)

16-Lead DIP (N)

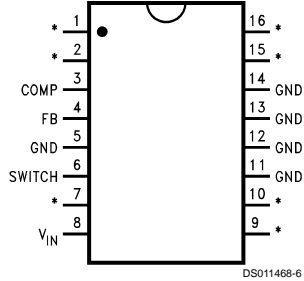

DS011468-6

*No internal Connection

Top View
Order Number LM2577N-12, LM2577N-15,
or LM2577N-ADJ
See NS Package Number N16A

24-Lead Surface Mount (M)

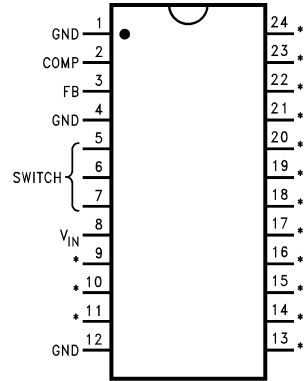

DS011468-7

*No internal Connection

Top View
Order Number LM2577M-12, LM2577M-15,
or LM2577M-ADJ
See NS Package Number M24B

TO-263 (S)
5-Lead Surface-Mount Package

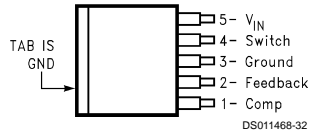

DS011468-32

Top View



DS011468-33

Side View
Order Number LM2577S-12, LM2577S-15,
or LM2577S-ADJ
See NS Package Number TS5B

4-Lead TO-3 (K)

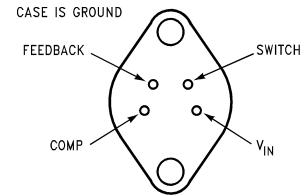

DS011468-8

Bottom View
Order Number LM1577K-12/883, LM1577K-15/883,
or LM1577K-ADJ/883
See NS Package Number K04A

LM1577-12, LM2577-12 Test Circuit

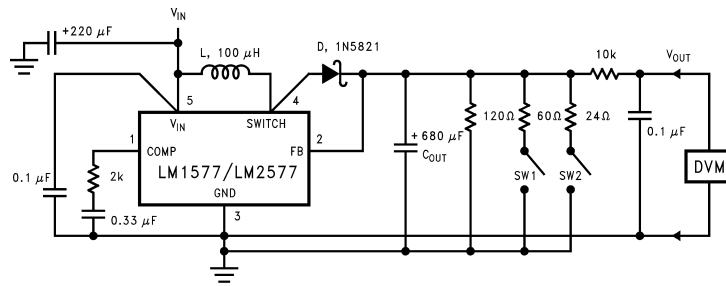

DS011468-30

L = 415-0930 (AIE)
 D = any manufacturer
 C_{OUT} = Sprague Type 673D
 Electrolytic 680 μF, 20V

Note: Pin numbers shown are for TO-220 (T) package

FIGURE 1. Circuit Used to Specify System Parameters for 12V Versions

LM1577-15, LM2577-15 Test Circuit

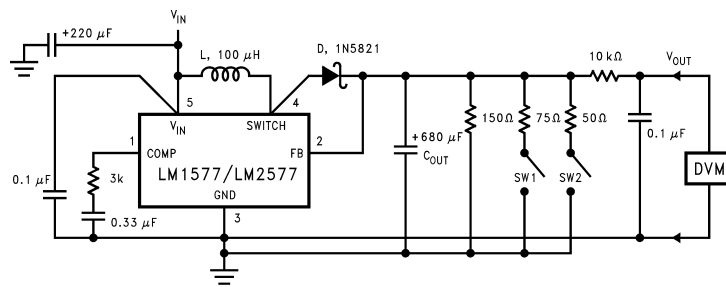

DS011468-26

L = 415-0930 (AIE)
 D = any manufacturer
 C_{OUT} = Sprague Type 673D
 Electrolytic 680 μF, 20V

Note: Pin numbers shown are for TO-220 (T) package

FIGURE 2. Circuit Used to Specify System Parameters for 15V Versions

LM1577-ADJ, LM2577-ADJ Test Circuit

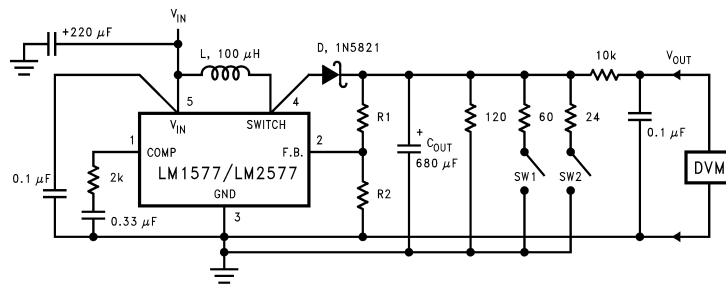

DS011468-9

L = 415-0930 (AIE)
 D = any manufacturer
 C_{OUT} = Sprague Type 673D
 Electrolytic 680 μF, 20V
 R1 = 48.7k in series with 511Ω (1%)
 R2 = 5.62k (1%)

Note: Pin numbers shown are for TO-220 (T) package

FIGURE 3. Circuit Used to Specify System Parameters for ADJ Versions

Application Hints

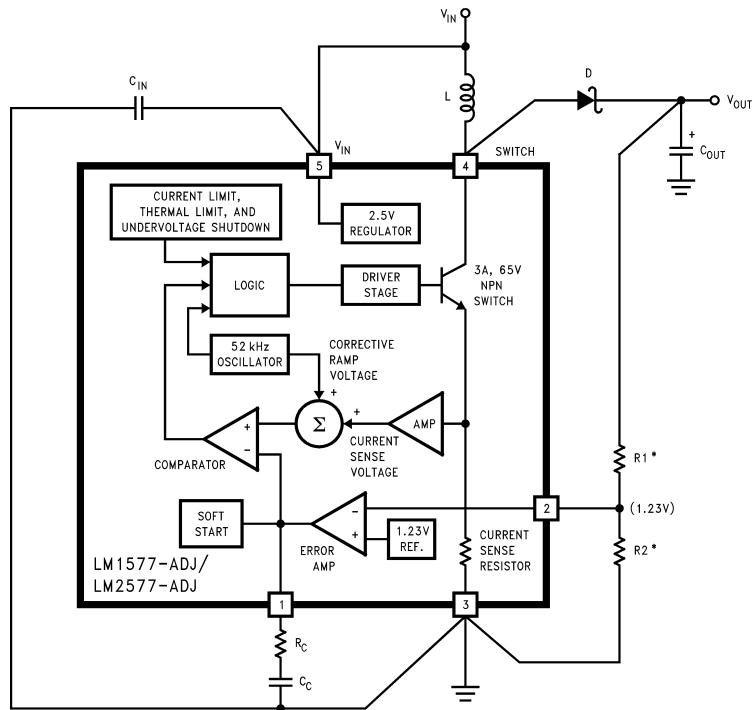

DS011468-10

Note: Pin numbers shown are for TO-220 (T) package
 *Resistors are internal to LM1577/LM2577 for 12V and 15V versions.

FIGURE 4. LM1577/LM2577 Block Diagram and Boost Regulator Application

Application Hints (Continued)

STEP-UP (BOOST) REGULATOR

Figure 4 shows the LM1577-ADJ/LM2577-ADJ used as a Step-Up Regulator. This is a switching regulator used for producing an output voltage greater than the input supply voltage. The LM1577-12/LM2577-12 and LM1577-15/LM2577-15 can also be used for step-up regulators with 12V or 15V outputs (respectively), by tying the feedback pin directly to the regulator output.

A basic explanation of how it works is as follows. The LM1577/LM2577 turns its output switch on and off at a frequency of 52 kHz, and this creates energy in the inductor (L). When the NPN switch turns on, the inductor current charges up at a rate of V_{IN}/L , storing current in the inductor. When the switch turns off, the lower end of the inductor flies above V_{IN} , discharging its current through diode (D) into the output capacitor (C_{OUT}) at a rate of $(V_{OUT} - V_{IN})/L$. Thus, energy stored in the inductor during the switch on time is transferred to the output during the switch off time. The output voltage is controlled by the amount of energy transferred which, in turn, is controlled by modulating the peak inductor current. This is done by feeding back a portion of the output voltage to the error amp, which amplifies the difference between the feedback voltage and a 1.230V reference. The error amp output voltage is compared to a voltage proportional to the switch current (i.e., inductor current during the switch on time).

The comparator terminates the switch on time when the two voltages are equal, thereby controlling the peak switch current to maintain a constant output voltage.

Voltage and current waveforms for this circuit are shown in Figure 5, and formulas for calculating them are given in Figure 6.

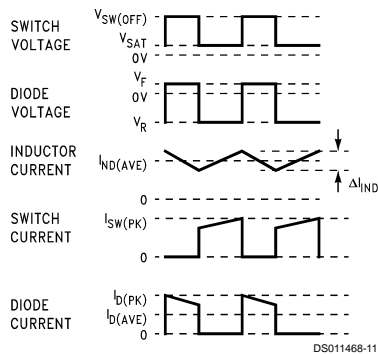

FIGURE 5. Step-Up Regulator Waveforms

Duty Cycle	D	$\frac{V_{OUT} + V_F - V_{IN}}{V_{OUT} + V_F - V_{SAT}} \approx \frac{V_{OUT} - V_{IN}}{V_{OUT}}$
Average Inductor Current	$I_{IND(AVE)}$	$\frac{I_{LOAD}}{1 - D}$
Inductor Current Ripple	ΔI_{IND}	$\frac{V_{IN} - V_{SAT}}{L} \frac{D}{52,000}$
Peak Inductor Current	$I_{IND(PK)}$	$\frac{I_{LOAD(max)}}{1 - D(max)} + \frac{\Delta I_{IND}}{2}$
Peak Switch Current	$I_{SW(PK)}$	$\frac{I_{LOAD(max)}}{1 - D(max)} + \frac{\Delta I_{IND}}{2}$
Switch Voltage When Off	$V_{SW(OFF)}$	$V_{OUT} + V_F$
Diode Reverse Voltage	V_R	$V_{OUT} - V_{SAT}$
Average Diode Current	$I_{D(AVE)}$	I_{LOAD}
Peak Diode Current	$I_{D(PK)}$	$\frac{I_{LOAD}}{1 - D(max)} + \frac{\Delta I_{IND}}{2}$
Power Dissipation of LM1577/2577	P_D	$0.25\Omega \left(\frac{I_{LOAD}}{1 - D} \right)^2 D + \frac{I_{LOAD} D V_{IN}}{50(1 - D)}$

V_F = Forward Biased Diode Voltage

I_{LOAD} = Output Load Current

FIGURE 6. Step-Up Regulator Formulas

STEP-UP REGULATOR DESIGN PROCEDURE

The following design procedure can be used to select the appropriate external components for the circuit in Figure 4, based on these system requirements.

Given:

$V_{IN(min)}$ = Minimum input supply voltage

V_{OUT} = Regulated output voltage

$I_{LOAD(max)}$ = Maximum output load current

Before proceeding any further, determine if the LM1577/LM2577 can provide these values of V_{OUT} and $I_{LOAD(max)}$ when operating with the minimum value of V_{IN} . The upper limits for V_{OUT} and $I_{LOAD(max)}$ are given by the following equations.

$$V_{OUT} \leq 60V$$

$$\text{and } V_{OUT} \leq 10 \times V_{IN(min)}$$

$$I_{LOAD(max)} \leq \frac{2.1A \times V_{IN(min)}}{V_{OUT}}$$

These limits must be greater than or equal to the values specified in this application.

1. Inductor Selection (L)

A. Voltage Options:

1. For 12V or 15V output

Application Hints (Continued)

From Figure 7 (for 12V output) or Figure 8 (for 15V output), identify inductor code for region indicated by $V_{IN(min)}$ and $I_{LOAD(max)}$. The shaded region indicates conditions for which the LM1577/LM2577 output switch would be operating beyond its switch current rating. The minimum operating voltage for the LM1577/LM2577 is 3.5V.

From here, **proceed to step C.**

2. For Adjustable version

Preliminary calculations:

The inductor selection is based on the calculation of the following three parameters:

$D_{(max)}$, the maximum switch duty cycle ($0 \leq D \leq 0.9$):

$$D_{(max)} = \frac{V_{OUT} + V_F - V_{IN(min)}}{V_{OUT} + V_F - 0.6V}$$

where $V_F = 0.5V$ for Schottky diodes and $0.8V$ for fast recovery diodes (typically);

$E \cdot T$, the product of volts x time that charges the inductor:

$$E \cdot T = \frac{D_{(max)} (V_{IN(min)} - 0.6V) 10^6}{52,000 \text{ Hz}} \quad (V \cdot \mu s)$$

$I_{IND,DC}$, the average inductor current under full load;

$$I_{IND,DC} = \frac{1.05 \times I_{LOAD(max)}}{1 - D_{(max)}}$$

B. Identify Inductor Value:

1. From Figure 9, identify the inductor code for the region indicated by the intersection of $E \cdot T$ and $I_{IND,DC}$. This code gives the inductor value in microhenries. The L or H prefix signifies whether the inductor is rated for a maximum $E \cdot T$ of $90 V \cdot \mu s$ (L) or $250 V \cdot \mu s$ (H).

2. If $D < 0.85$, go on to step C. If $D \geq 0.85$, then calculate the minimum inductance needed to ensure the switching regulator's stability:

$$L_{MIN} = \frac{6.4 (V_{IN(min)} - 0.6V) (2D_{(max)} - 1)}{1 - D_{(max)}} \quad (\mu H)$$

If L_{MIN} is smaller than the inductor value found in step B1, go on to step C. Otherwise, the inductor value found in step B1 is too low; an appropriate inductor code should be obtained from the graph as follows:

1. Find the lowest value inductor that is greater than L_{MIN} .
2. Find where $E \cdot T$ intersects this inductor value to determine if it has an L or H prefix. If $E \cdot T$ intersects both the L and H regions, select the inductor with an H prefix.

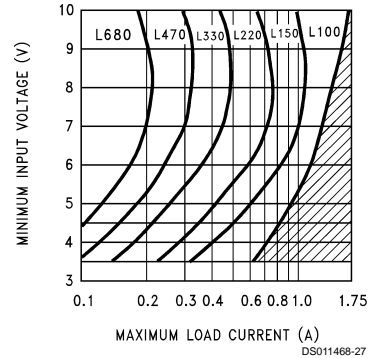

FIGURE 7. LM2577-12 Inductor Selection Guide

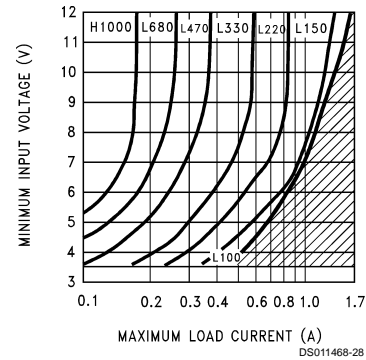
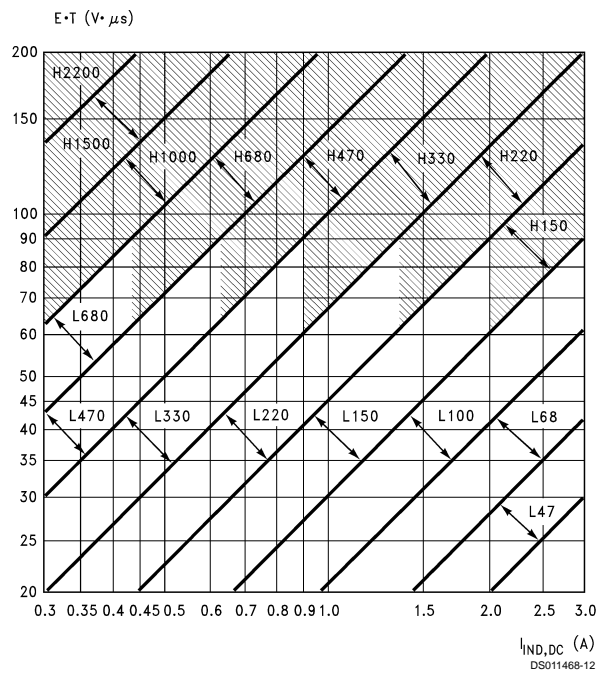

FIGURE 8. LM2577-15 Inductor Selection Guide

Application Hints (Continued)



Note: These charts assume that the inductor ripple current is approximately 20% to 30% of the average inductor current (when the regulator is under full load). Greater ripple current causes higher peak switch currents and greater output ripple voltage; lower ripple current is achieved with larger-value inductors. The factor of 20 to 30% is chosen as a convenient balance between the two extremes.

FIGURE 9. LM1577-ADJ/LM2577-ADJ Inductor Selection Graph

- C. Select an inductor from the table of Figure 10 which cross-references the inductor codes to the part numbers of three different manufacturers. Complete specifications for these inductors are available from the respective manufacturers. The inductors listed in this table have the following characteristics:

A/E: ferrite, pot-core inductors; Benefits of this type are low electro-magnetic interference (EMI), small physical size, and very low power dissipation (core loss). Be careful not to operate these inductors too far beyond their maximum ratings for E·T and peak current, as this will saturate the core.

Pulse: powdered iron, toroid core inductors; Benefits are low EMI and ability to withstand E·T and peak current above rated value better than ferrite cores.

Renco: ferrite, bobbin-core inductors; Benefits are low cost and best ability to withstand E·T and peak current above rated value. Be aware that these inductors generate more EMI than the other types, and this may interfere with signals sensitive to noise.

Application Hints (Continued)

Inductor Code	Manufacturer's Part Number		
	Schott	Pulse	Renco
L47	67126980	PE - 53112	RL2442
L68	67126990	PE - 92114	RL2443
L100	67127000	PE - 92108	RL2444
L150	67127010	PE - 53113	RL1954
L220	67127020	PE - 52626	RL1953
L330	67127030	PE - 52627	RL1952
L470	67127040	PE - 53114	RL1951
L680	67127050	PE - 52629	RL1950
H150	67127060	PE - 53115	RL2445
H220	67127070	PE - 53116	RL2446
H330	67127080	PE - 53117	RL2447
H470	67127090	PE - 53118	RL1961
H680	67127100	PE - 53119	RL1960
H1000	67127110	PE - 53120	RL1959
H1500	67127120	PE - 53121	RL1958
H2200	67127130	PE - 53122	RL2448

Schott Corp., (612) 475-1173
1000 Parkers Lake Rd., Wayzata, MN 55391
Pulse Engineering, (619) 268-2400
P.O. Box 12235, San Diego, CA 92112
Renco Electronics Inc., (516) 586-5566
60 Jeffryn Blvd. East, Deer Park, NY 11729

FIGURE 10. Table of Standardized Inductors and Manufacturer's Part Numbers

2. Compensation Network (R_C , C_C) and Output Capacitor (C_{OUT}) Selection

R_C and C_C form a pole-zero compensation network that stabilizes the regulator. The values of R_C and C_C are mainly dependent on the regulator voltage gain, $I_{LOAD(max)}$, L and C_{OUT} . The following procedure calculates values for R_C , C_C , and C_{OUT} that ensure regulator stability. Be aware that this procedure doesn't necessarily result in R_C and C_C that provide optimum compensation. In order to guarantee optimum compensation, one of the standard procedures for testing loop stability must be used, such as measuring V_{OUT} transient response when pulsing I_{LOAD} (see Figure 15).

A. First, calculate the maximum value for R_C .

$$R_C \leq \frac{750 \times I_{LOAD(max)} \times V_{OUT}^2}{V_{IN(min)}^2}$$

Select a resistor less than or equal to this value, and it should also be no greater than 3 k Ω .

B. Calculate the minimum value for C_{OUT} using the following two equations.

$$C_{OUT} \geq \frac{0.19 \times L \times R_C \times I_{LOAD(max)}}{V_{IN(min)} \times V_{OUT}}$$

and

$$C_{OUT} \geq \frac{V_{IN(min)} \times R_C \times (V_{IN(min)} + (3.74 \times 10^5 \times L))}{487,800 \times V_{OUT}^3}$$

The larger of these two values is the minimum value that ensures stability.

C. Calculate the minimum value of C_C .

$$C_C \geq \frac{58.5 \times V_{OUT}^2 \times C_{OUT}}{R_C^2 \times V_{IN(min)}}$$

The compensation capacitor is also part of the soft start circuitry. When power to the regulator is turned on, the switch duty cycle is allowed to rise at a rate controlled by this capacitor (with no control on the duty cycle, it would immediately rise to 90%, drawing huge currents from the input power supply). In order to operate properly, the soft start circuit requires $C_C \geq 0.22 \mu\text{F}$.

The value of the output filter capacitor is normally large enough to require the use of aluminum electrolytic capacitors. Figure 11 lists several different types that are recommended for switching regulators, and the following parameters are used to select the proper capacitor.

Working Voltage (WVDC): Choose a capacitor with a working voltage at least 20% higher than the regulator output voltage.

Ripple Current: This is the maximum RMS value of current that charges the capacitor during each switching cycle. For step-up and flyback regulators, the formula for ripple current is

$$I_{RIPPLE(RMS)} = \frac{I_{LOAD(max)} \times D_{(max)}}{1 - D_{(max)}}$$

Choose a capacitor that is rated at least 50% higher than this value at 52 kHz.

Equivalent Series Resistance (ESR): This is the primary cause of output ripple voltage, and it also affects the values of R_C and C_C needed to stabilize the regulator. As a result, the preceding calculations for C_C and R_C are only valid if ESR doesn't exceed the maximum value specified by the following equations.

$$ESR \leq \frac{0.01 \times V_{OUT}}{I_{RIPPLE(P-P)}} \text{ and } \leq \frac{8.7 \times (10) - 3 \times V_{IN}}{I_{LOAD(max)}}$$

where

$$I_{RIPPLE(P-P)} = \frac{1.15 \times I_{LOAD(max)}}{1 - D_{(max)}}$$

Select a capacitor with ESR, at 52 kHz, that is less than or equal to the lower value calculated. Most electrolytic capacitors specify ESR at 120 Hz which is 15% to 30% higher than at 52 kHz. Also, be aware that ESR increases by a factor of 2 when operating at -20°C .

In general, low values of ESR are achieved by using large value capacitors ($C \geq 470 \mu\text{F}$), and capacitors with high WVDC, or by paralleling smaller-value capacitors.

Application Hints (Continued)

3. Output Voltage Selection (R1 and R2)

This section is for applications using the LM1577-ADJ/LM2577-ADJ. Skip this section if the LM1577-12/LM2577-12 or LM1577-15/LM2577-15 is being used.

With the LM1577-ADJ/LM2577-ADJ, the output voltage is given by

$$V_{OUT} = 1.23V (1 + R1/R2)$$

Resistors R1 and R2 divide the output down so it can be compared with the LM1577-ADJ/LM2577-ADJ internal 1.23V reference. For a given desired output voltage V_{OUT} , select R1 and R2 so that

$$\frac{R1}{R2} = \frac{V_{OUT}}{1.23V} - 1$$

4. Input Capacitor Selection (C_{IN})

The switching action in the step-up regulator causes a triangular ripple current to be drawn from the supply source. This in turn causes noise to appear on the supply voltage. For proper operation of the LM1577, the input voltage should be decoupled. Bypassing the Input Voltage pin directly to ground with a good quality, low ESR, 0.1 μ F capacitor (leads as short as possible) is normally sufficient.

Cornell Dublier — Types 239, 250, 251, UFT, 300, or 350

P.O. Box 128, Pickens, SC 29671
(803) 878-6311

Nichicon — Types PF, PX, or PZ

927 East Parkway,
Schaumburg, IL 60173
(708) 843-7500

Sprague — Types 672D, 673D, or 674D

Box 1, Sprague Road,
Lansing, NC 28643
(919) 384-2551

United Chemi-Con — Types LX, SXF, or SXJ

9801 West Higgins Road,
Rosemont, IL 60018
(708) 696-2000

FIGURE 11. Aluminum Electrolytic Capacitors Recommended for Switching Regulators

If the LM1577 is located far from the supply source filter capacitors, an additional large electrolytic capacitor (e.g. 47 μ F) is often required.

5. Diode Selection (D)

The switching diode used in the boost regulator must withstand a reverse voltage equal to the circuit output voltage, and must conduct the peak output current of the LM2577. A suitable diode must have a minimum reverse breakdown voltage greater than the circuit output voltage, and should be rated for average and peak current greater than $I_{LOAD(max)}$ and $I_{D(PK)}$. Schottky barrier diodes are often favored for use in switching regulators. Their low forward voltage drop allows higher regulator efficiency than if a (less expensive) fast recovery diode was used. See *Figure 12* for recommended part numbers and voltage ratings of 1A and 3A diodes.

V_{OUT} (max)	Schottky		Fast Recovery	
	1A	3A	1A	3A
20V	1N5817 MBR120P	1N5820 MBR320P		
30V	1N5818 MBR130P 11DQ03	1N5821 MBR330P 31DQ03		
40V	1N5819 MBR140P 11DQ04	1N5822 MBR340P 31DQ04		
50V	MBR150 11DQ05	MBR350 31DQ05	1N4933 MUR105	
100V			1N4934 HER102 MUR110 10DL1	MR851 30DL1 MR831 HER302

FIGURE 12. Diode Selection Chart

BOOST REGULATOR CIRCUIT EXAMPLE

By adding a few external components (as shown in *Figure 13*), the LM2577 can be used to produce a regulated output voltage that is greater than the applied input voltage. Typical performance of this regulator is shown in *Figure 14* and *Figure 15*. The switching waveforms observed during the operation of this circuit are shown in *Figure 16*.

Application Hints (Continued)

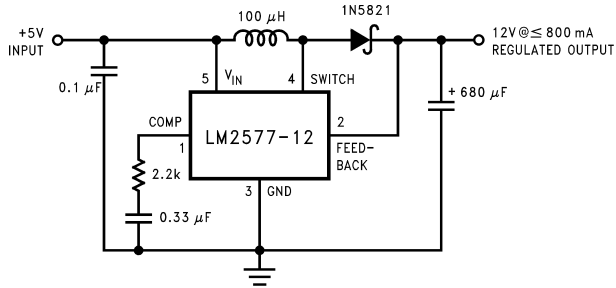

DS011468-13

Note: Pin numbers shown are for TO-220 (T) package.

FIGURE 13. Step-Up Regulator Delivers 12V from a 5V Input

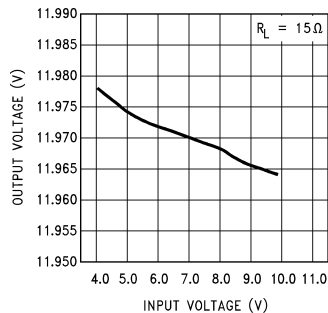

DS011468-14

FIGURE 14. Line Regulation (Typical) of Step-Up Regulator of Figure 13

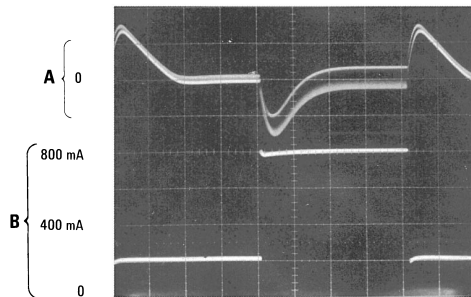

DS011468-15

A: Output Voltage Change, 100 mV/div. (AC-coupled)
 B: Load current, 0.2 A/div
 Horizontal: 5 ms/div

FIGURE 15. Load Transient Response of Step-Up Regulator of Figure 13

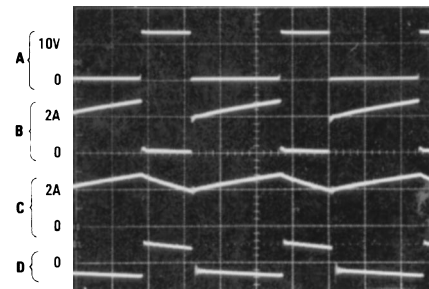

DS011468-16

A: Switch pin voltage, 10 V/div
 B: Switch pin current, 2 A/div
 C: Inductor current, 2 A/div
 D: Output ripple voltage, 100 mV/div (AC-coupled)
 Horizontal: 5 μs/div

FIGURE 16. Switching Waveforms of Step-Up Regulator of Figure 13

Application Hints (Continued)

FLYBACK REGULATOR

A Flyback regulator can produce single or multiple output voltages that are lower or greater than the input supply voltage. Figure 18 shows the LM1577/LM2577 used as a flyback regulator with positive and negative regulated outputs. Its operation is similar to a step-up regulator, except the output switch controls the primary current of a flyback transformer. Note that the primary and secondary windings are out of phase, so no current flows through secondary when current flows through the primary. This allows the primary to charge up the transformer core when the switch is on. When the switch turns off, the core discharges by sending current through the secondary, and this produces voltage at the outputs. The output voltages are controlled by adjusting the peak primary current, as described in the step-up regulator section.

Voltage and current waveforms for this circuit are shown in Figure 17, and formulas for calculating them are given in Figure 19.

FLYBACK REGULATOR DESIGN PROCEDURE

1. Transformer Selection

A family of standardized flyback transformers is available for creating flyback regulators that produce dual output voltages, from $\pm 10V$ to $\pm 15V$, as shown in Figure 18. Figure 20 lists these transformers with the input voltage, output voltages and maximum load current they are designed for.

2. Compensation Network (C_C , R_C) and Output Capacitor (C_{OUT}) Selection

As explained in the Step-Up Regulator Design Procedure, C_C , R_C and C_{OUT} must be selected as a group. The following procedure is for a dual output flyback regulator with equal turns ratios for each secondary (i.e., both output voltages have the same magnitude). The equations can be used for a single output regulator by changing $\Sigma I_{LOAD(max)}$ to $I_{LOAD(max)}$ in the following equations.

A. First, calculate the maximum value for R_C .

$$R_C \leq \frac{750 \times \Sigma I_{LOAD(max)} \times (15V + V_{IN(min)})^2}{V_{IN(min)}^2}$$

Where $\Sigma I_{LOAD(max)}$ is the sum of the load current (magnitude) required from both outputs. Select a resistor less than or equal to this value, and no greater than 3 k Ω .

B. Calculate the minimum value for ΣC_{OUT} (sum of C_{OUT} at both outputs) using the following two equations.

$$C_{OUT} \geq \frac{0.19 \times R_C \times L_P \times \Sigma I_{LOAD(max)}}{15V \times V_{IN(min)}}$$

and

$$C_{OUT} \geq \frac{V_{IN(min)} \times R_C \times N^2 \times (V_{IN(min)} + (3.74 \times 10^5 \times L_P))}{487,800 \times (15V)^2 \times (15V + V_{IN(min)} \times N)}$$

The larger of these two values must be used to ensure regulator stability.

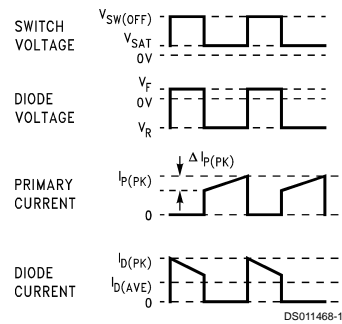
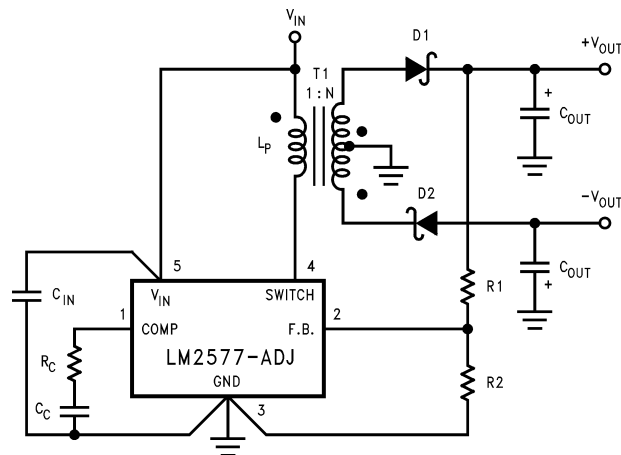

FIGURE 17. Flyback Regulator Waveforms



T1 = Pulse Engineering, PE-65300
D1, D2 = 1N5821

FIGURE 18. LM1577-ADJ/LM2577-ADJ Flyback Regulator with \pm Outputs

Application Hints (Continued)

Duty Cycle	D	$\frac{V_{OUT} + V_F}{N(V_{IN} - V_{SAT}) + V_{OUT} + V_F} \approx \frac{V_{OUT}}{N(V_{IN}) + V_{OUT}}$
Primary Current Variation	ΔI_P	$\frac{D(V_{IN} - V_{SAT})}{L_P \times 52,000}$
Peak Primary Current	$I_{P(PK)}$	$\frac{N}{\eta} \times \frac{\Sigma I_{LOAD}}{1 - D} + \frac{\Delta I_{PK}}{2}$
Switch Voltage when Off	$V_{SW(OFF)}$	$V_{IN} + \frac{V_{OUT} + V_F}{N}$
Diode Reverse Voltage	V_R	$V_{OUT} + N(V_{IN} - V_{SAT})$
Average Diode Current	$I_{D(AVE)}$	I_{LOAD}
Peak Diode Current	$I_{D(PK)}$	$\frac{I_{LOAD}}{1 - D} + \frac{\Delta I_{IND}}{2}$
Short Circuit Diode Current		$\approx \frac{6A}{N}$
Power Dissipation of LM1577/LM2577	P_D	$0.25\Omega \left(\frac{N \Sigma I_{LOAD}}{1 - D} \right)^2 + \frac{N I_{LOAD} D}{50(1 - D)} V_{IN}$

$$N = \text{Transformer Turns Ratio} = \frac{\text{number of secondary turns}}{\text{number of primary turns}}$$

$$\eta = \text{Transformer Efficiency (typically 0.95)}$$

$$\Sigma I_{LOAD} = |I_{LOAD}| + |-I_{LOAD}|$$

DS011468-78

FIGURE 19. Flyback Regulator Formulas

C. Calculate the minimum value of C_C

$$C_C \geq \frac{58.5 \times C_{OUT} \times V_{OUT} \times (V_{OUT} + (V_{IN(min)} \times N))}{R_C^2 \times V_{IN(min)} \times N}$$

D. Calculate the maximum ESR of the $+V_{OUT}$ and $-V_{OUT}$ output capacitors in parallel.

$$ESR + \parallel ESR \leq \frac{8.7 \times 10^{-3} \times V_{IN(min)} \times V_{OUT} \times N}{\Sigma I_{LOAD(max)} \times (V_{OUT} + (V_{IN(min)} \times N))}$$

This formula can also be used to calculate the maximum ESR of a single output regulator.

At this point, refer to this same section in the **Step-Up Regulator Design Procedure** for more information regarding the selection of C_{OUT} .

3. Output Voltage Selection

This section is for applications using the LM1577-ADJ/LM2577-ADJ. Skip this section if the LM1577-12/LM2577-12 or LM1577-15/LM2577-15 is being used.

With the LM1577-ADJ/LM2577-ADJ, the output voltage is given by

$$V_{OUT} = 1.23V (1 + R1/R2)$$

Resistors R1 and R2 divide the output voltage down so it can be compared with the LM1577-ADJ/LM2577-ADJ internal 1.23V reference. For a desired output voltage V_{OUT} , select R1 and R2 so that

$$\frac{R1}{R2} = \frac{V_{OUT}}{1.23V} - 1$$

4. Diode Selection

The switching diode in a flyback converter must withstand the reverse voltage specified by the following equation.

$$V_R = V_{OUT} + \frac{V_{IN}}{N}$$

A suitable diode must have a reverse voltage rating greater than this. In addition it must be rated for more than the average and peak diode currents listed in *Figure 19*.

5. Input Capacitor Selection

The primary of a flyback transformer draws discontinuous pulses of current from the input supply. As a result, a flyback regulator generates more noise at the input supply than a step-up regulator, and this requires a larger bypass capacitor to decouple the LM1577/LM2577 V_{IN} pin from this noise. For most applications, a low ESR, 1.0 μ F cap will be sufficient, if it is connected very close to the V_{IN} and Ground pins.

Application Hints (Continued)

Transformer Type	Input Voltage	Dual Output Voltage	Maximum Output Current
1 $L_p = 100 \mu\text{H}$ $N = 1$	5V	$\pm 10\text{V}$	325 mA
	5V	$\pm 12\text{V}$	275 mA
	5V	$\pm 15\text{V}$	225 mA
2 $L_p = 200 \mu\text{H}$ $N = 0.5$	10V	$\pm 10\text{V}$	700 mA
	10V	$\pm 12\text{V}$	575 mA
	10V	$\pm 15\text{V}$	500 mA
	12V	$\pm 10\text{V}$	800 mA
	12V	$\pm 12\text{V}$	700 mA
3 $L_p = 250 \mu\text{H}$ $N = 0.5$	15V	$\pm 10\text{V}$	900 mA
	15V	$\pm 12\text{V}$	825 mA
	15V	$\pm 15\text{V}$	700 mA

Transformer Type	Manufacturers' Part Numbers		
	AIE	Pulse	Renco
1	326-0637	PE-65300	RL-2580
2	330-0202	PE-65301	RL-2581
3	330-0203	PE-65302	RL-2582

FIGURE 20. Flyback Transformer Selection Guide

In addition to this bypass cap, a larger capacitor ($\geq 47 \mu\text{F}$) should be used where the flyback transformer connects to the input supply. This will attenuate noise which may interfere with other circuits connected to the same input supply voltage.

6. Snubber Circuit

A "snubber" circuit is required when operating from input voltages greater than 10V, or when using a transformer with $L_p \geq 200 \mu\text{H}$. This circuit clamps a voltage spike from the transformer primary that occurs immediately after the output switch turns off. Without it, the switch voltage may exceed the 65V maximum rating. As shown in Figure 21, the snubber consists of a fast recovery diode, and a parallel RC. The

RC values are selected for switch clamp voltage (V_{CLAMP}) that is 5V to 10V greater than $V_{\text{SW(OFF)}}$. Use the following equations to calculate R and C;

$$C \geq \frac{0.02 \times L_p \times I_{p(\text{PK})}^2}{(V_{\text{CLAMP}})^2 - (V_{\text{SW(OFF)}})^2}$$

$$R \leq \left(\frac{V_{\text{CLAMP}} + V_{\text{SW(OFF)}} - V_{\text{IN}}}{2} \right)^2 \times \left(\frac{19.2 \times 10^{-4}}{L_p \times I_{p(\text{PK})}^2} \right)$$

Power dissipation (and power rating) of the resistor is;

$$P = \left(\frac{V_{\text{CLAMP}} + V_{\text{SW(OFF)}} - V_{\text{IN}}}{2} \right)^2 / R$$

The fast recovery diode must have a reverse voltage rating greater than V_{CLAMP} .

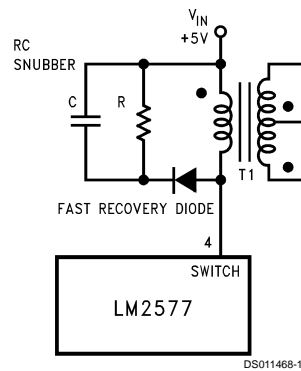
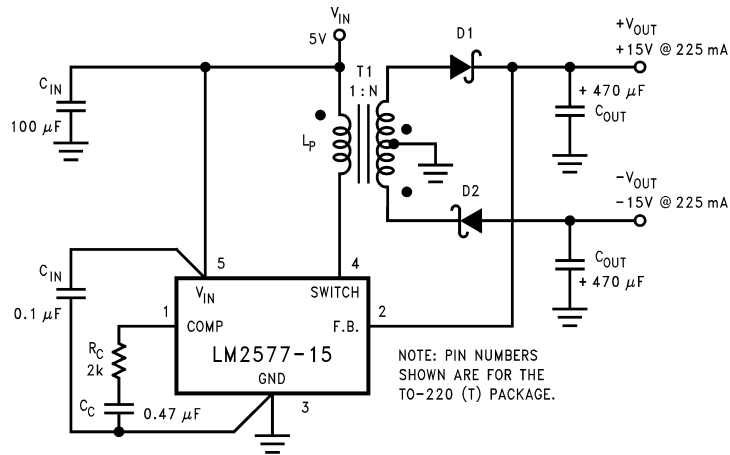

FIGURE 21. Snubber Circuit

FLYBACK REGULATOR CIRCUIT EXAMPLE

The circuit of Figure 22 produces $\pm 15\text{V}$ (at 225 mA each) from a single 5V input. The output regulation of this circuit is shown in Figure 23 and Figure 25, while the load transient response is shown in Figure 24 and Figure 26. Switching waveforms seen in this circuit are shown in Figure 27.

Application Hints (Continued)



DS011468-20

T1 = Pulse Engineering, PE-65300
D1, D2 = 1N5821

FIGURE 22. Flyback Regulator Easily Provides Dual Outputs

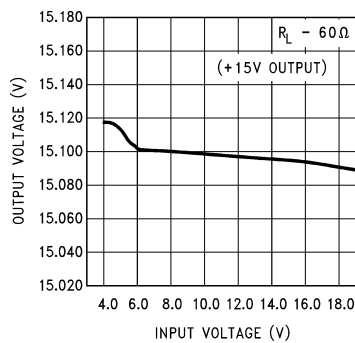

DS011468-21

FIGURE 23. Line Regulation (Typical) of Flyback Regulator of Figure 22, +15V Output

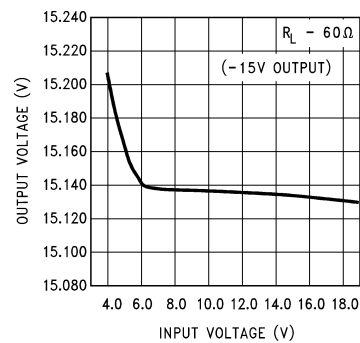

DS011468-22

FIGURE 25. Line Regulation (Typical) of Flyback Regulator of Figure 22, -15V Output

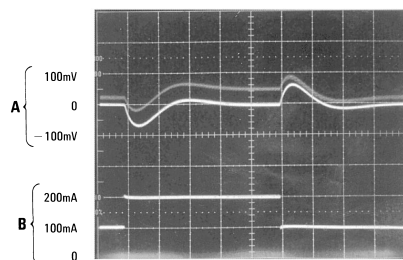

DS011468-23

A: Output Voltage Change, 100 mV/div
B: Output Current, 100 mA/div
Horizontal: 10 ms/div

FIGURE 24. Load Transient Response of Flyback Regulator of Figure 22, +15V Output

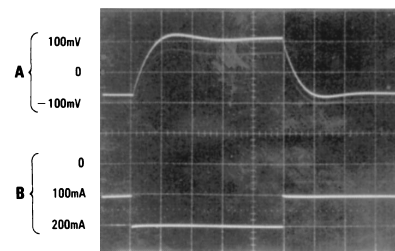

DS011468-24

A: Output Voltage Change, 100 mV/div
B: Output Current, 100 mA/div
Horizontal: 10 ms/div

FIGURE 26. Load Transient Response of Flyback Regulator of Figure 22, -15V Output

Application Hints (Continued)

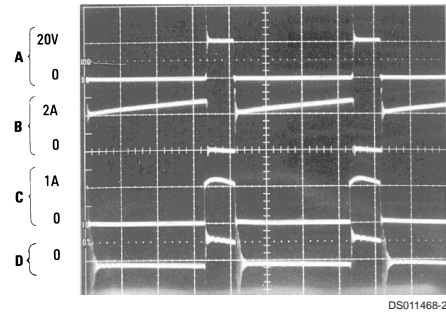

A: Switch pin voltage, 20 V/div
B: Primary current, 2 A/div
C: +15V Secondary current, 1 A/div
D: +15V Output ripple voltage, 100 mV/div
Horizontal: 5 μ s/div

FIGURE 27. Switching Waveforms of Flyback Regulator of Figure 22, Each Output Loaded with 60 Ω

Physical Dimensions inches (millimeters) unless otherwise noted

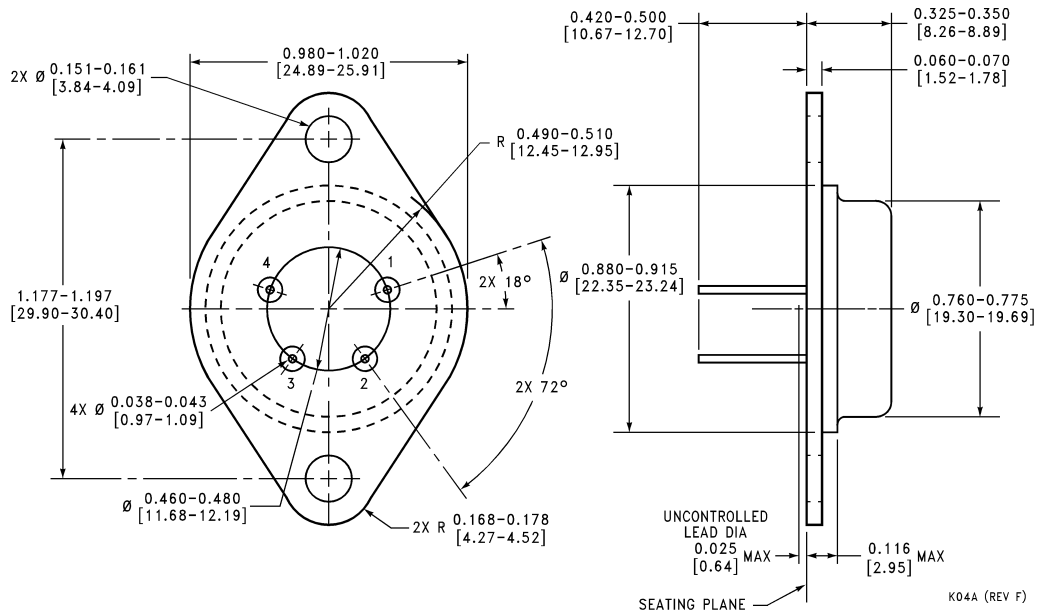

TO-3 Metal Can Package (K)
Order Number LM1577K-12/883, LM1577K-15/883, or LM1577K-ADJ/883
NS Package Number K04A

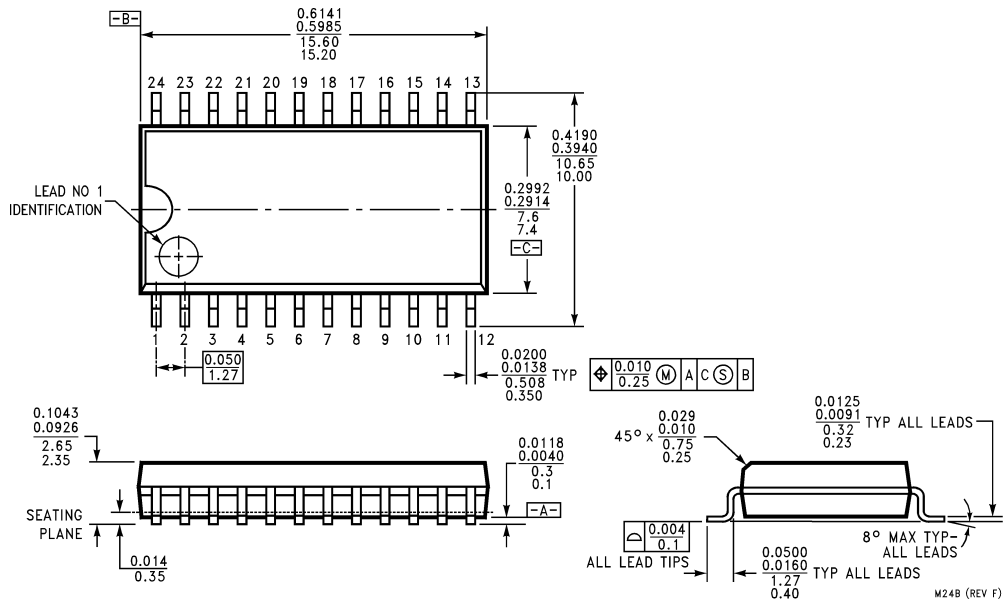

0.300 Wide SO Package (M)
Order Number LM2577M-12, LM2577M-15 or LM2577M-ADJ
NS Package Number M24B

Physical Dimensions inches (millimeters) unless otherwise noted (Continued)

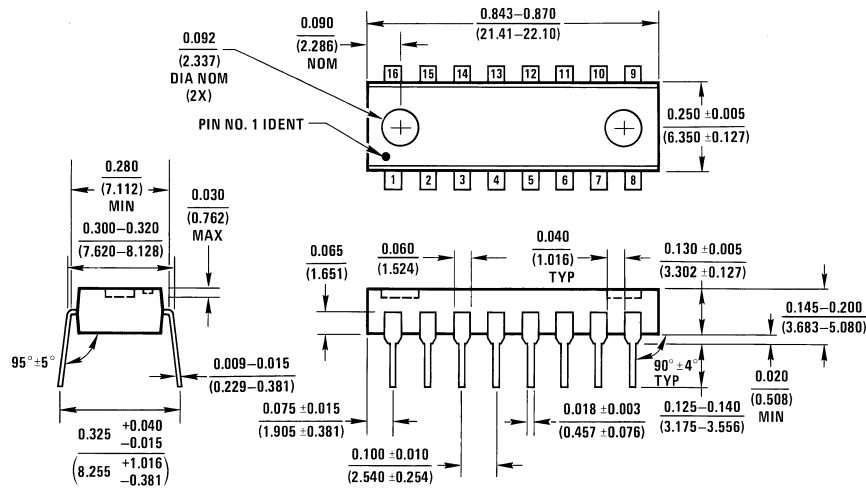

N16A (REV E)

Molded Dual-In-Line Package (N)
 Order Number LM2577N-12, LM2577N-15, or LM2577N-ADJ
 NS Package Number N16A

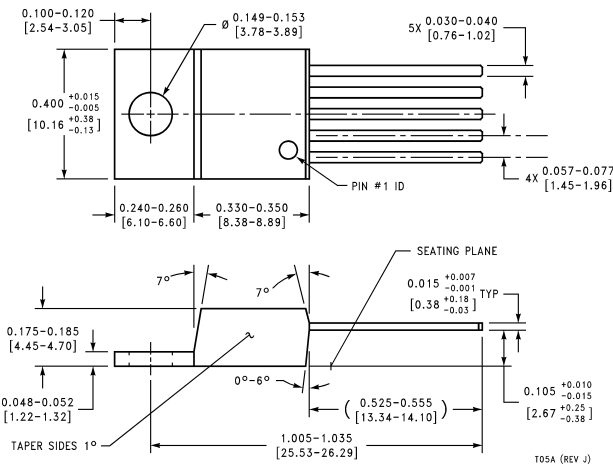

TO5A (REV J)

TO-220, Straight Leads (T)
 Order Number LM2577T-12, LM2577T-15, or LM2577T-ADJ
 NS Package Number TO5A

Physical Dimensions inches (millimeters) unless otherwise noted (Continued)

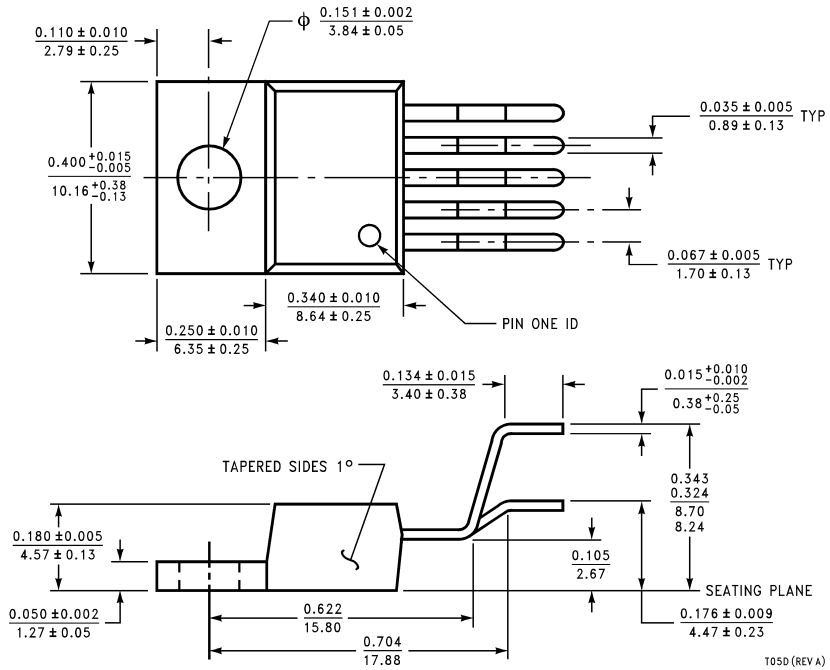

TO-220, Bent Staggered Leads (T)
Order Number LM2577T-12 Flow LB03, LM2577T-15 Flow LB03, or LM2577T-ADJ Flow LB03
NS Package Number T05D

Physical Dimensions inches (millimeters) unless otherwise noted (Continued)

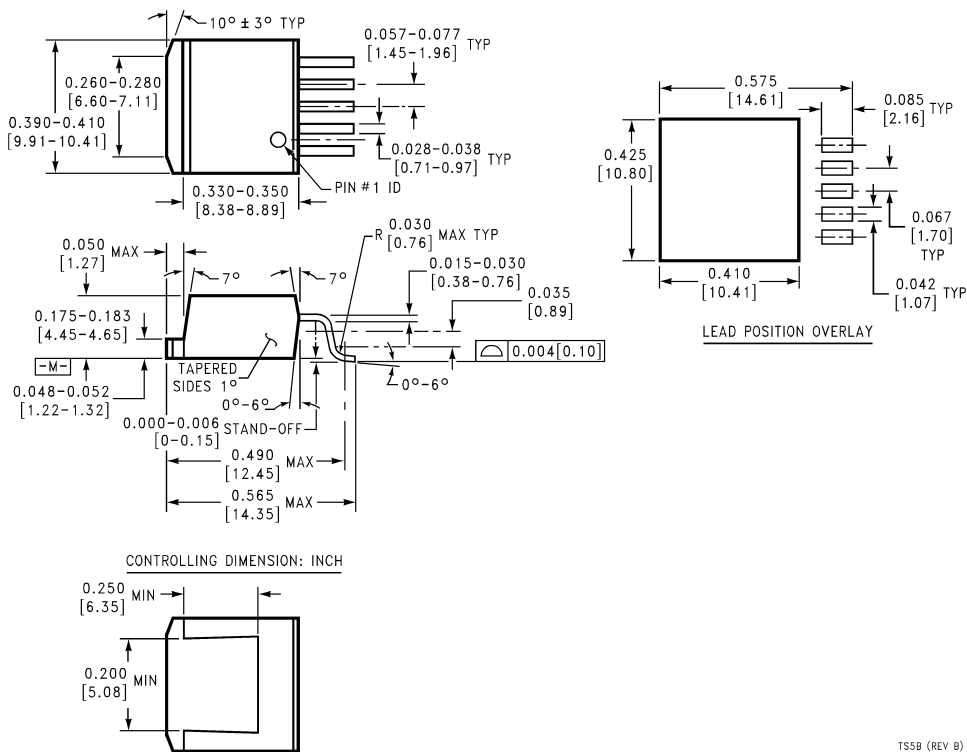

5-Lead TO-263 (S)
Order Number LM2577S-12, LM2577S-15 or LM2577S-ADJ
NS Package Number TS5B

TSSB (REV B)

LIFE SUPPORT POLICY

NATIONAL'S PRODUCTS ARE NOT AUTHORIZED FOR USE AS CRITICAL COMPONENTS IN LIFE SUPPORT DEVICES OR SYSTEMS WITHOUT THE EXPRESS WRITTEN APPROVAL OF THE PRESIDENT AND GENERAL COUNSEL OF NATIONAL SEMICONDUCTOR CORPORATION. As used herein:

1. Life support devices or systems are devices or systems which, (a) are intended for surgical implant into the body, or (b) support or sustain life, and whose failure to perform when properly used in accordance with instructions for use provided in the labeling, can be reasonably expected to result in a significant injury to the user.
2. A critical component is any component of a life support device or system whose failure to perform can be reasonably expected to cause the failure of the life support device or system, or to affect its safety or effectiveness.

National Semiconductor Corporation
 Americas
 Tel: 1-800-272-9959
 Fax: 1-800-737-7018
 Email: support@nsc.com
 www.national.com

National Semiconductor Europe
 Fax: +49 (0) 1 80-530 85 86
 Email: europe.support@nsc.com
 Deutsch Tel: +49 (0) 1 80-530 85 85
 English Tel: +49 (0) 1 80-532 78 32
 Français Tel: +49 (0) 1 80-532 93 58
 Italiano Tel: +49 (0) 1 80-534 16 80

National Semiconductor Asia Pacific Customer Response Group
 Tel: 65-2544466
 Fax: 65-2504466
 Email: sea.support@nsc.com

National Semiconductor Japan Ltd.
 Tel: 81-3-5639-7560
 Fax: 81-3-5639-7507

National does not assume any responsibility for use of any circuitry described, no circuit patent licenses are implied and National reserves the right at any time without notice to change said circuitry and specifications.