

FAN4174 / FAN4274

Single and Dual, Ultra-Low Cost, Rail-to-Rail I/O, CMOS Amplifier

Features

- 200µA Supply Current per Amplifier
- 3.7MHz Bandwidth
- Output Swing to Within 10mV of Either Rail
- Input Voltage Range Exceeds the Rails
- 3V/µs Slew Rate
- 25nV/√Hz Input Voltage Noise
- Replaces KM4170 and KM4270
- FAN4174 Competes with OPA340 and TLV2461; Available in SC70-5 and SOT23-5 Packages
- FAN4274 Competes with OPA2340 and TLV2462; Available in MSOP-8 Package
- Fully Specified at +2.7V and +5V Supplies

Applications

- Portable / Battery-powered Applications
- PCMCIA, USB
- Mobile Communications, Cellular Phones, Pagers
- Notebooks and PDAs
- Sensor Interface
- A/D Buffer
- Active Filters
- Signal Conditioning
- Portable Test Instruments

Description

The FAN4174 (single) and FAN4274 (dual) are ultra-low cost voltage feedback amplifiers with CMOS inputs that consume only 200µA of supply current per amplifier, while providing ±33mA of output short-circuit current. These amplifiers are designed to operate from 2.5V to 5V supplies. The common mode voltage range extends beyond the negative and positive rails.

The FAN4174 and FAN4274 are designed on a CMOS process and provide 3.7MHz of bandwidth and 3V/µs of slew rate at a supply voltage of 5V. The combination of low power, rail-to-rail performance, low-voltage operation, and tiny package options make this amplifier family well suited for use in many general-purpose and battery-powered applications.

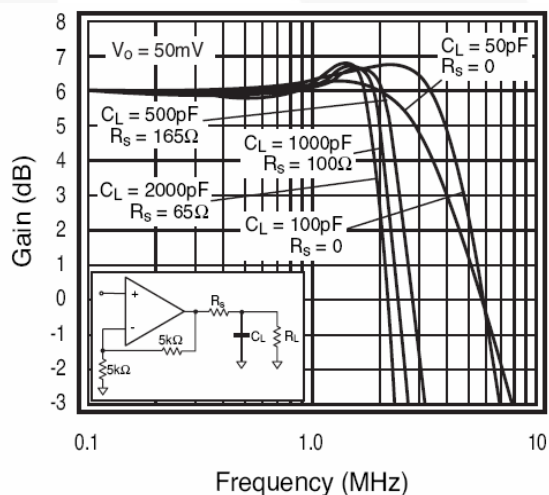

Figure 1. Frequency vs. Gain

Ordering Information

Part Number	Operating Temperature Range	Package	Eco Status	Packing Method
FAN4174IP5X	-40 to +85°C	5-Lead SC70 Package	RoHS	Tape and Reel (3000)
FAN4174IS5X	-40 to +85°C	5-Lead SOT23 Package	RoHS	Tape and Reel (3000)
FAN4274IMU8X	-40 to +85°C	8-Lead Molded Small Outline Package	RoHS	Tape and Reel (3000)

For Fairchild's definition of "green" Eco Status, please visit: http://www.fairchildsemi.com/company/green/rohs_green.html.

Typical Application

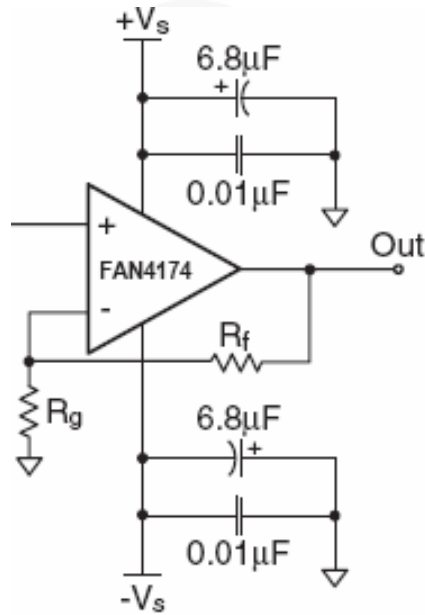

Figure 2. Pin Configuration



Pin Configurations

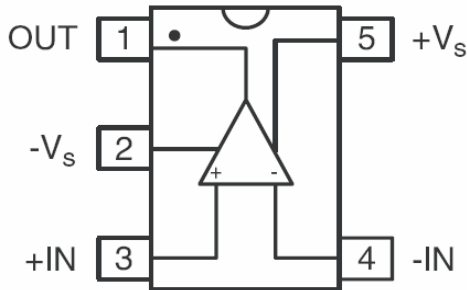

Figure 3. FAN4174 SOT23

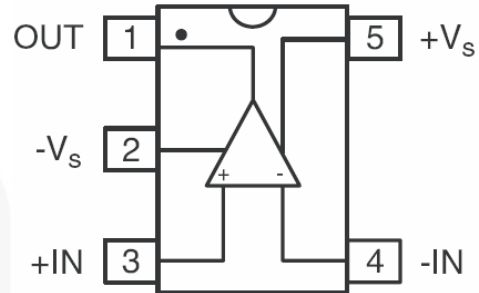

Figure 4. FAN4174 SC70

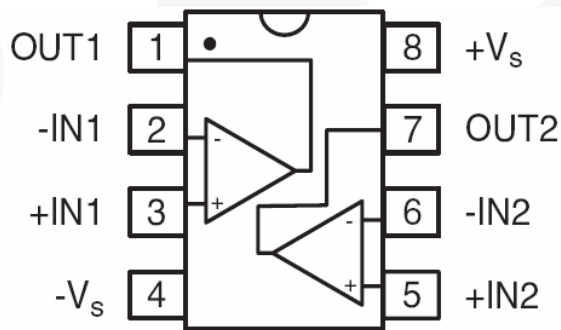

Figure 5. FAN4274 MSOP

FAN4174 Pin Assignments

Pin #	Name	Description
1	OUT	Output
2	-Vs	Negative Supply
3	+IN	Positive Supply
4	-IN	Negative Input
5	+Vs	Positive Supply

FAN4274 Pin Assignments

Pin #	Name	Description
1	OUT1	Output, Channel 1
2	-IN1	Negative Input, Channel 1
3	+IN1	Positive Input, Channel 1
4	-Vs	Negative Supply
5	+IN2	Positive Input, Channel 2
6	-IN2	Negative Input, Channel 2
7	OUT2	Output, Channel 2
8	+Vs	Positive Supply

Absolute Maximum Ratings

Stresses exceeding the absolute maximum ratings may damage the device. The device may not function or be operable above the recommended operating conditions and stressing the parts to these levels is not recommended. In addition, extended exposure to stresses above the recommended operating conditions may affect device reliability. The absolute maximum ratings are stress ratings only. Functional operation under any of these conditions is NOT implied. Performance and reliability are guaranteed only if operating conditions are not exceeded.

Symbol	Parameter	Min.	Max.	Unit
V _{CC}	Supply Voltage	0	6	V
V _{IN}	Input Voltage Range	-V _S -0.5	+V _S +0.5	V
T _J	Junction Temperature		+150	°C
T _{STG}	Storage Temperature	-65	+150	°C
T _L	Lead Soldering, 10 Seconds		+300	°C
Θ _{JA}	Thermal Resistance ⁽¹⁾	5-Lead SOT23	256	°C/W
		5-Lead SC70	331	
		8-Lead MSOP	206	

Note:

1. Package thermal resistance JEDEC standard, multi-layer test boards, still air.

Recommended Operating Conditions

The Recommended Operating Conditions table defines the conditions for actual device operation. Recommended operating conditions are specified to ensure optimal performance to the datasheet specifications. Fairchild does not recommend exceeding them or designing to Absolute Maximum Ratings.

Symbol	Parameter	Min.	Typ.	Max.	Unit
T _A	Operating Temperature Range	-40		+85	°C

Electrical Specifications at +2.7V

$V_S=+2.7V$, $G=2$, $R_L=10k\Omega$ to $V_S/2$, $R_F=5k\Omega$; unless otherwise noted.

Symbol	Parameter	Conditions	Min.	Typ.	Max.	Units
Frequency Domain Response						
UGBW	-3dB Bandwidth	$G=+1$		4		MHz
BW _{SS}				2.5		MHz
GBWP	Gain Bandwidth Product			4		MHz
Time Domain Response						
t_R, t_F	Rise and Fall Time	$V_O=1.0V$ Step		300		ns
OS	Overshoot	$V_O=1.0V$ Step		5		%
SR	Slew Rate	$V_O=3V$ Step, $G=-1$		3		V/ μ s
Distortion and Noise Response						
HD2	2nd Harmonic Distortion	$V_O=1V_{PP}$, 10kHz		-66		dBc
HD3	3rd Harmonic Distortion	$V_O=1V_{PP}$, 10kHz		-67		dBc
THD	Total Harmonic Distortion	$V_O=1V_{PP}$, 10kHz		0.1		%
e_n	Input Voltage Noise			26		nV/ \sqrt{Hz}
X _{TALK}	Crosstalk (FAN4274)	100kHz		-100		dB
DC Performance						
V_{IO}	Input Offset Voltage ⁽²⁾		-6	0	+6	mV
dV_{IO}	Average Drift			2.1		μ V/ $^{\circ}$ C
I_{bn}	Input Bias Current			5		pA
PSRR	Power Supply Rejection Ratio ⁽²⁾	DC	50	73		dB
A_{OL}	Open-loop Gain	DC		98		dB
I_S	Supply Current per Amplifier ⁽²⁾			200	300	μ A
Input Characteristics						
R_{IN}	Input Resistance			10		G Ω
C_{IN}	Input Capacitance			1.4		pF
CMIR	Input Common Mode Voltage Range	FAN4174 (Typical)		-0.3 to 2.6		V
		FAN4274 (Typical)		-0.3 to 3.0		
CMRR	Common Mode Rejection Ratio ⁽²⁾	FAN4174	DC, $V_{CM}=0V$ to 2.2V	50	65	dB
		FAN4274	DC, $V_{CM}=0V$ to 2.2V	50	65	
Output Characteristics						
V_O	Output Voltage Swing ⁽²⁾	$R_L=10k\Omega$ to $V_S/2$	0.03	0.01 to 2.69	2.65	V
		$R_L=1k\Omega$ to $V_S/2$		0.05 to 2.55		
I_{SC}	Short Circuit Output Current			+34/-12		mA
V_S	Power Supply Operating Range			2.5 to 5.5		V

Note:

2. 100% tested at 25 $^{\circ}$ C.

Electrical Specifications at +5V

$V_S=+5V$, $G=2$, $R_L=10k\Omega$ to $V_S/2$, $R_F=5k\Omega$; unless otherwise noted.

Symbol	Parameter	Conditions	Min.	Typ.	Max.	Units
Frequency Domain Response						
UGBW	-3dB Bandwidth	$G=+1$		3.7		MHz
BW _{SS}				2.3		MHz
GBWP	Gain Bandwidth Product			3.7		MHz
Time Domain Response						
t_R, t_F	Rise and Fall Time	$V_O=1.0V$ Step		300		ns
OS	Overshoot	$V_O=1.0V$ Step		5		%
SR	Slew Rate	$V_O=3V$ Step, $G=-1$		3		V/ μ s
Distortion and Noise Response						
HD2	2nd Harmonic Distortion	$V_O=1V_{PP}$, 10kHz		-80		dBc
HD3	3rd Harmonic Distortion	$V_O=1V_{PP}$, 10kHz		-80		dBc
THD	Total Harmonic Distortion	$V_O=1V_{PP}$, 10kHz		0.02		%
e_n	Input Voltage Noise			25		nV/ \sqrt{Hz}
X _{TALK}	Crosstalk (FAN4274)	100kHz		-100		dB
DC Performance						
V_{IO}	Input Offset Voltage ⁽³⁾		-8	0	+8	mV
dV_{IO}	Average Drift			2.9		μ V/ $^{\circ}$ C
I_{bn}	Input Bias Current			5		pA
PSRR	Power Supply Rejection Ratio ⁽³⁾	DC	50	73		dB
A_{OL}	Open-loop Gain	DC		102		dB
I_S	Supply Current per Amplifier ⁽³⁾			200	300	μ A
Input Characteristics						
R_{IN}	Input Resistance			10		G Ω
C_{IN}	Input Capacitance			1.2		pF
CMIR	Input Common Mode Voltage Range	Typical		-0.3 to 5.3		V
CMRR	Common Mode Rejection Ratio ⁽³⁾	DC, $V_{CM}=0V$ to V_S	58	73		dB
Output Characteristics						
V_O	Output Voltage Swing ⁽³⁾	$R_L=10k\Omega$ to $V_S/2$	0.03	0.01 to 4.99	4.95	V
		$R_L=1k\Omega$ to $V_S/2$		0.1 to 4.9		
I_{SC}	Short Circuit Output Current			± 33		mA
V_S	Power Supply Operating Range			2.5 to 5.5		V

Note:

3. 100% tested at 25°C.

Typical Performance Characteristics

$V_S=+2.7$, $G=2$, $R_L=10k\Omega$ to $V_S/2$, $R_F=5k\Omega$; unless otherwise noted.

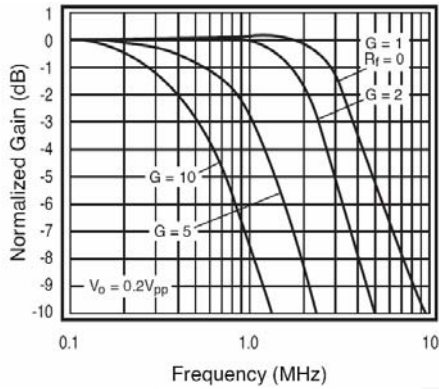

Figure 6. Non-Inverting Frequency Response (+5V)

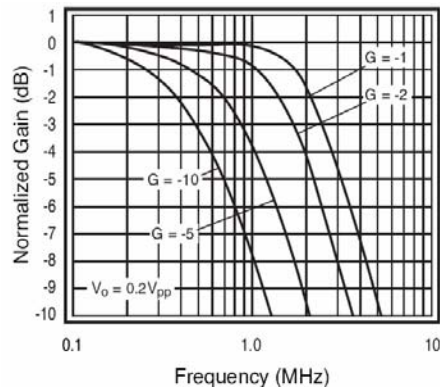

Figure 7. Inverting Frequency Response (+5V)

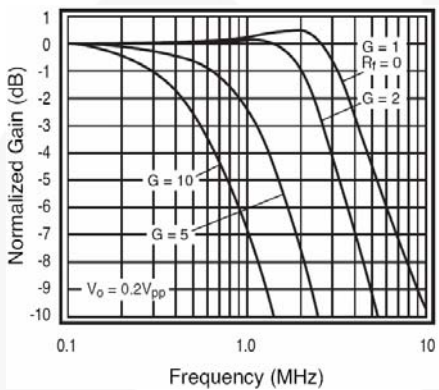

Figure 8. Non-Inverting Frequency Response

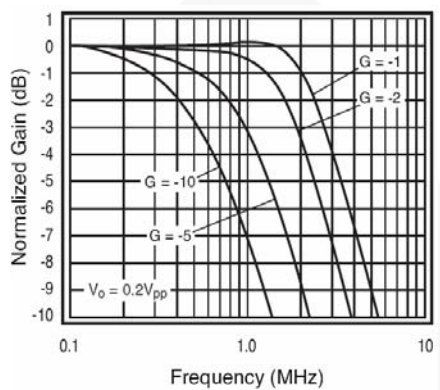

Figure 9. Inverting Frequency Response

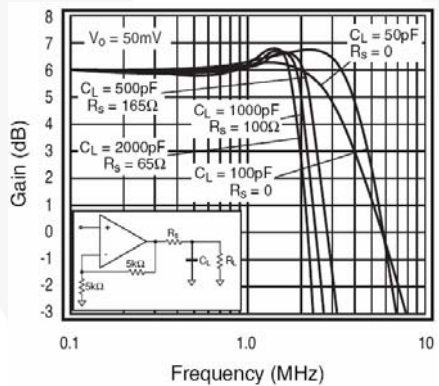

Figure 10. Frequency Response vs. C_L

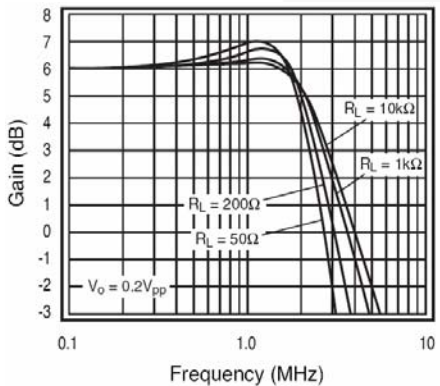

Figure 11. Frequency Response vs. R_L

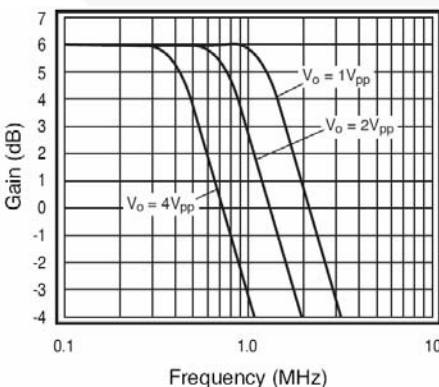

Figure 12. Large Signal Frequency Response (+5V)

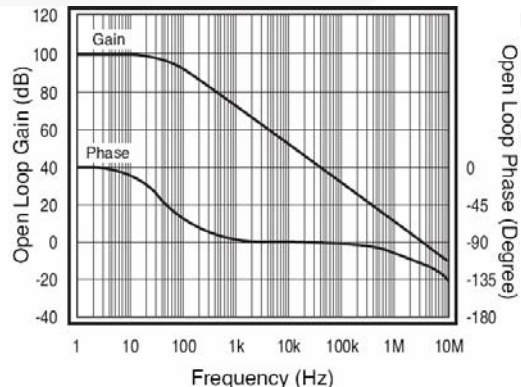

Figure 13. Open-loop Gain and Phase vs. Frequency

Typical Performance Characteristic

$V_S=+2.7$, $G=2$, $R_L=10k\Omega$ to $V_S/2$, $R_F=5k\Omega$; unless otherwise noted.

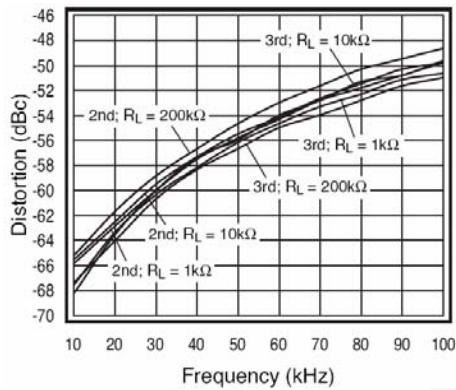

Figure 14. 2nd and 3rd Harmonic Distortion

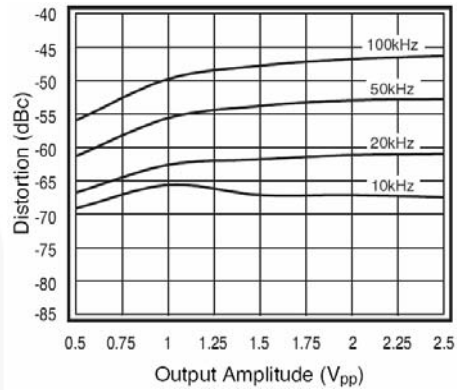

Figure 15. 2nd Harmonic Distortion vs. V_O

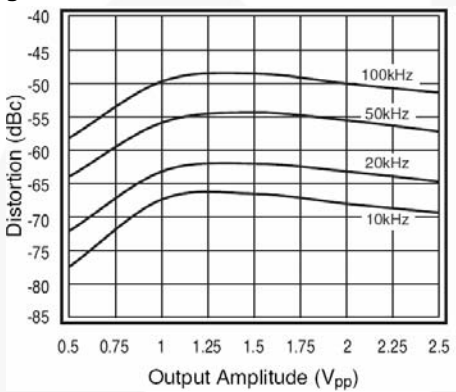

Figure 16. 3rd Harmonic Distortion vs. V_O

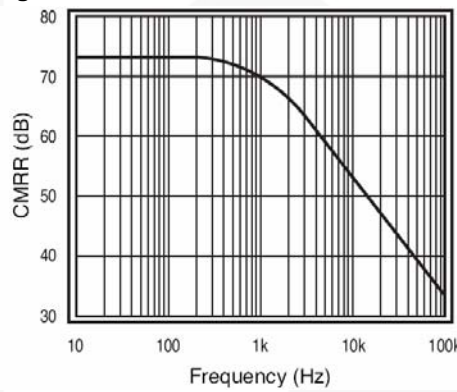

Figure 17. CMRR $V_S=5V$

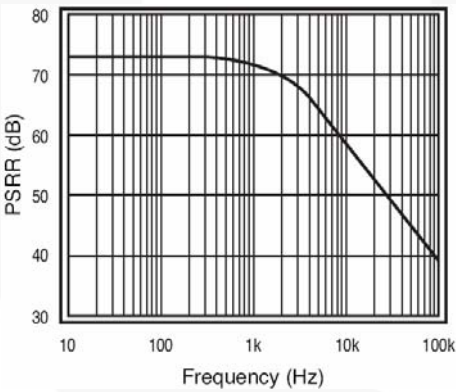

Figure 18. PSRR $V_S=5V$

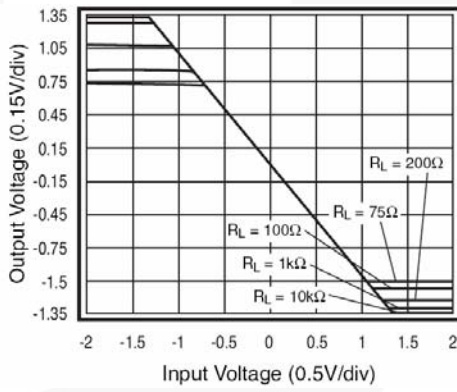

Figure 19. Output Swing vs. Load

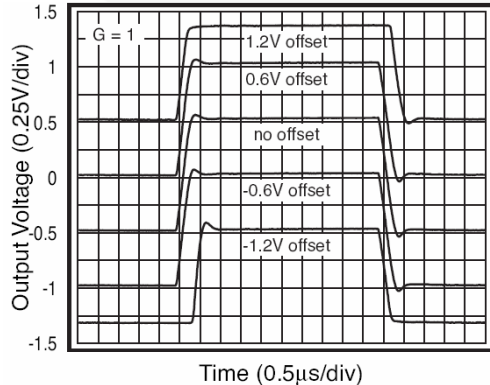

Figure 20. Pulse Response vs. Common Mode Voltage

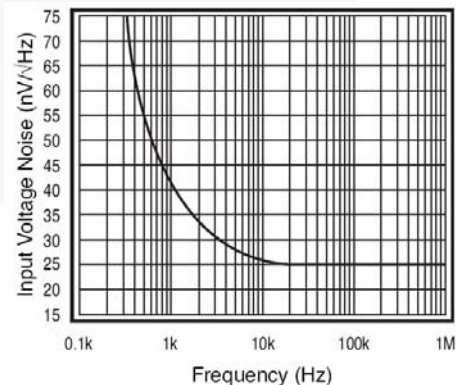

Figure 21. Input Voltage Noise

Application Information

General Description

The FAN4174 amplifier includes single-supply, general-purpose, voltage-feedback amplifiers, fabricated on a bi-CMOS process. The family features a rail-to-rail input and output and is unity gain stable. The typical non-inverting circuit schematic is shown in Figure 22.

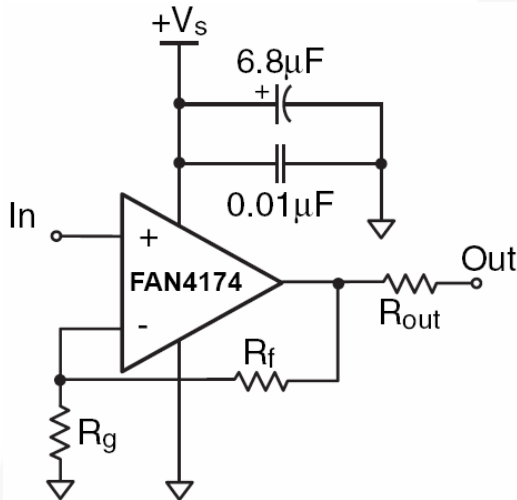

Figure 22. Typical Non-inverting Configuration

Input Common Mode Voltage

The common mode input range extends to 300mV below ground and to 100mV above V_S in single supply operation. Exceeding these values does not cause phase reversal; however, if the input voltage exceeds the rails by more than 0.5V, the input ESD devices begin to conduct. The output stays at the rail during this overdrive condition. If the absolute maximum input V_{IN} (700mV beyond either rail) is exceeded, externally limit the input current to $\pm 5\text{mA}$, as shown in Figure 23.

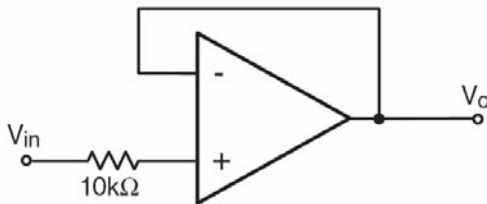

Figure 23. Circuit for Input Current Protection

Power Dissipation

The maximum internal power dissipation allowed is directly related to the maximum junction temperature. If the maximum junction temperature exceeds 150°C , performance degradation occurs. If the maximum junction temperature exceeds 150°C for an extended time, device failure may occur.

Overdrive Recovery

Overdrive of an amplifier occurs when the output and/or input ranges are exceeded. The recovery time varies based on whether the input or output is overdriven and by how much the range is exceeded. The FAN4174 typically recovers in less than 500ns from an overdrive condition. Figure 24 shows the FAN4174 amplifier in an overdriven condition.

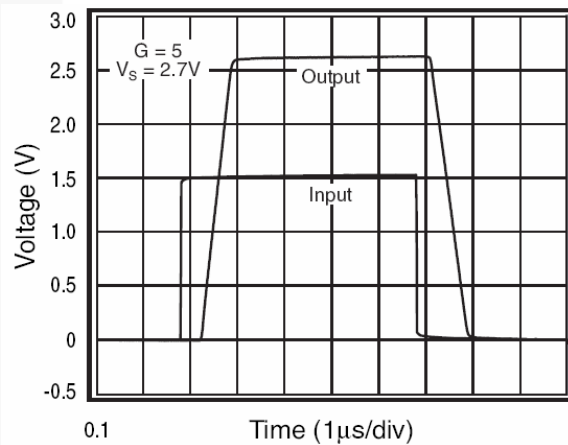

Figure 24. Overdrive Recovery

Driving Capacitive Loads

Figure 10 illustrates the response of the FAN4174 amplifier family. A small series resistance (R_S) at the output of the amplifier, illustrated in Figure 25, improves stability and settling performance. R_S values in Figure 10 were chosen to achieve maximum bandwidth with less than 2dB of peaking. For maximum flatness, use a larger R_S . Capacitive loads larger than 500pF require the use of R_S .

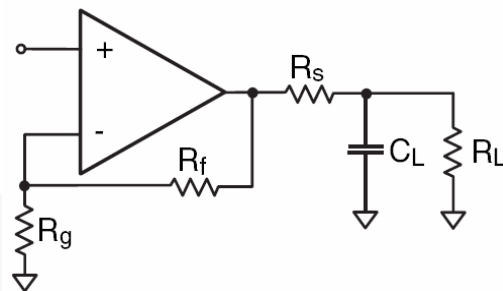

Figure 25. Typical Topology for Driving a Capacitive Load

Driving a capacitive load introduces phase-lag into the output signal, which reduces phase margin in the amplifier. The unity gain follower is the most sensitive configuration. In a unity gain follower configuration, the FAN4174 amplifier family requires a 300Ω series resistor to drive a 100pF load.

Layout Considerations

General layout and supply bypassing play major roles in high-frequency performance. Fairchild evaluation boards help guide high-frequency layout and aid in device testing and characterization. Follow the steps below as a basis for high-frequency layout:

1. Include 6.8 μ F and 0.01 μ F ceramic capacitors.
2. Place the 6.8 μ F capacitor within 0.75 inches of the power pin.
3. Place the 0.01 μ F capacitor within 0.1 inches of the power pin.
4. Remove the ground plane under and around the part, especially near the input and output pins, to reduce parasitic capacitance.

Minimize all trace lengths to reduce series inductances.

Refer to the evaluation board layouts shown in Figures 28-31 for more information.

When evaluating only one channel, complete the following on the unused channel:

1. Ground the non-inverting input.
2. Short the output to the inverting input.

Evaluation Board Information

The following evaluation boards are available to aid in the testing and layout of this device:

Evaluation Board	Description	Products
KEB002	Single Channel, Dual Supply, 5 and 6-Lead SOT23	FAN4174IS5X
KEB010	Dual Channel, Dual Supply 8-Lead MSOP	FAN4274IMU8X
KEB011	Single Channel, Dual Supply, 5 and 6-Lead SC70	FAN4174IP5X

Evaluation board schematics are shown in Figure 26 and Figure 27; layouts are shown in Figures 28-31.

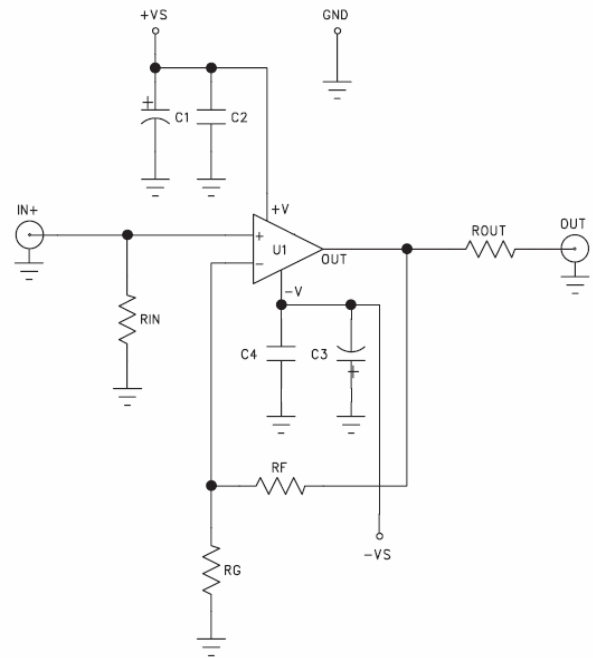

Figure 26. FAN4174 Evaluation Board Schematic (KEV002/KEB011)

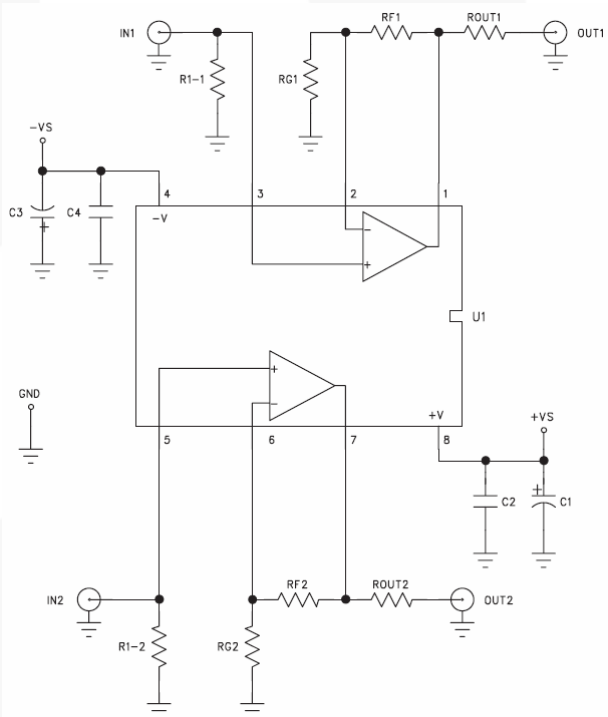

Figure 27. FAN4274 Evaluation Board Schematic (KEB010)

Board Layout Information

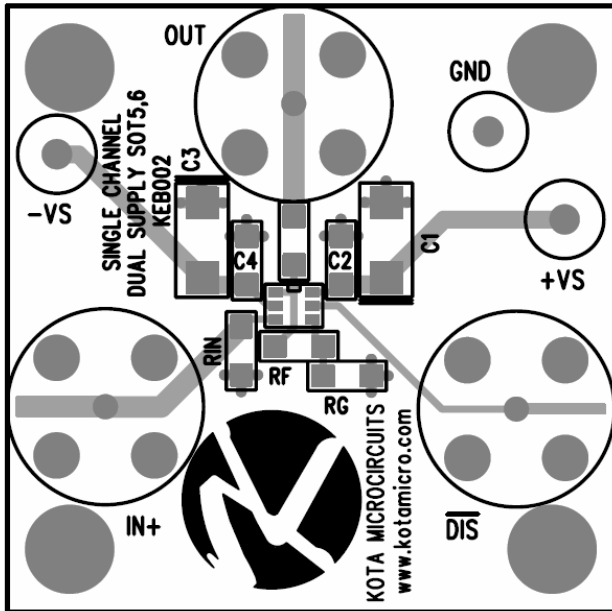

Figure 28. KEB002 (Top Side)

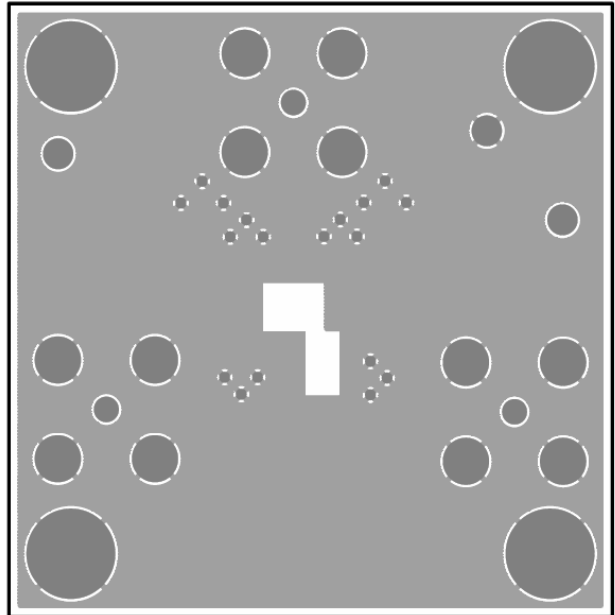

Figure 29. KEB002 (Bottom Side)

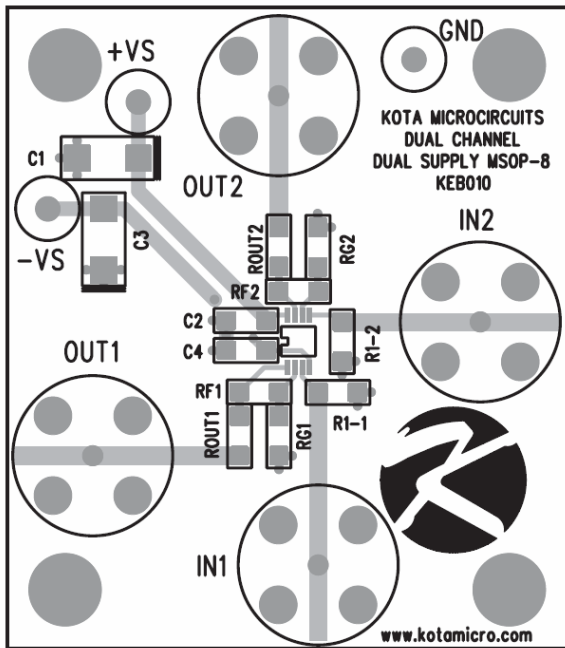

Figure 30. KEB010 (Top Side)

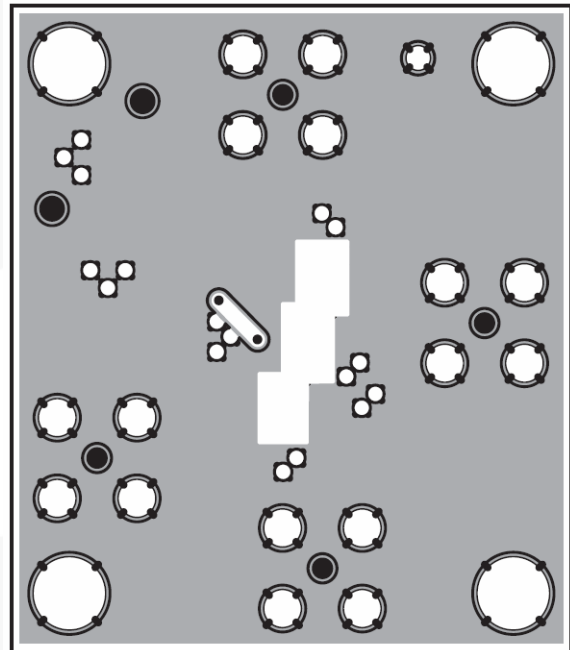

Figure 31. KEB010 (Bottom Side)

Physical Dimensions

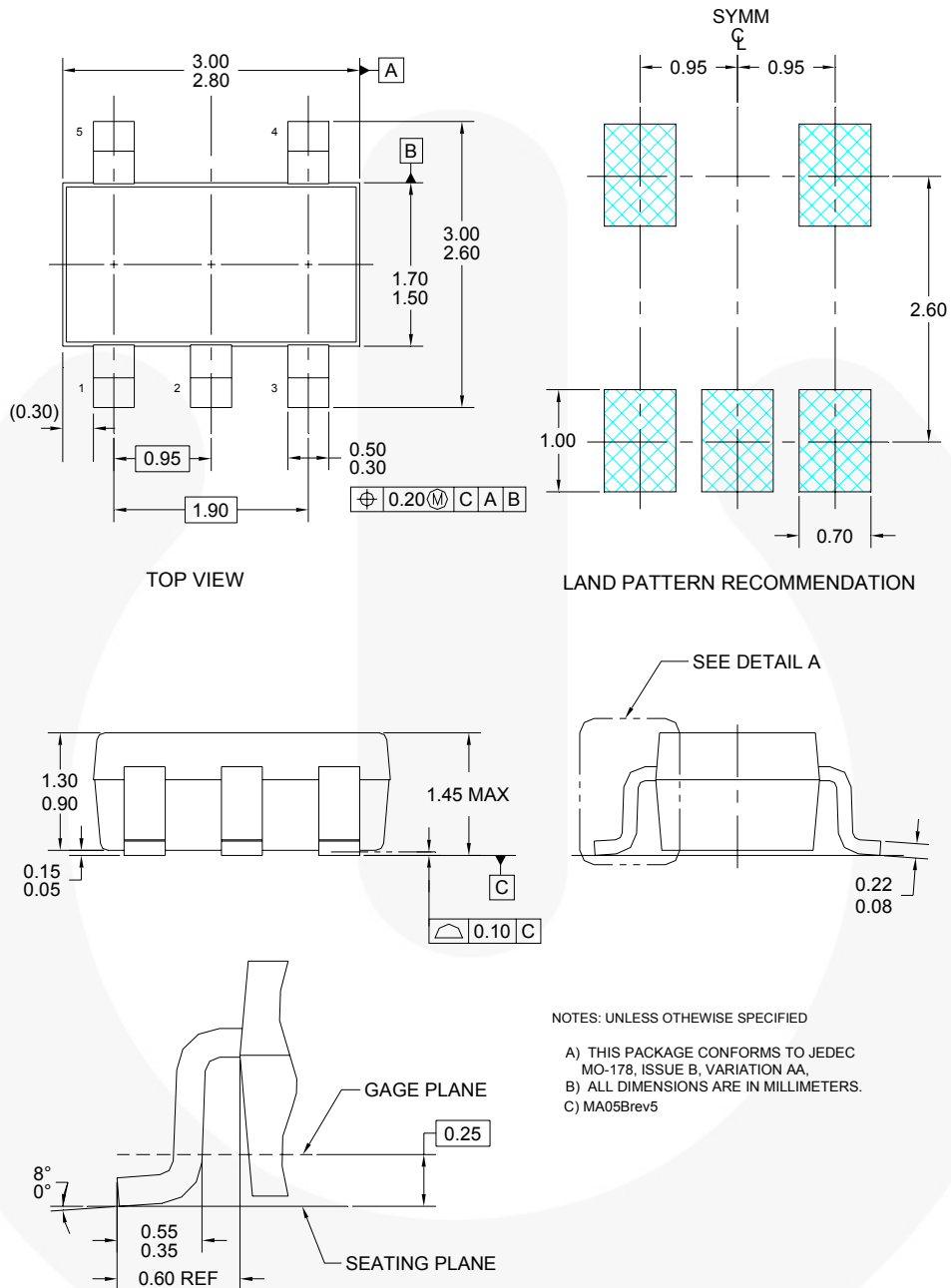
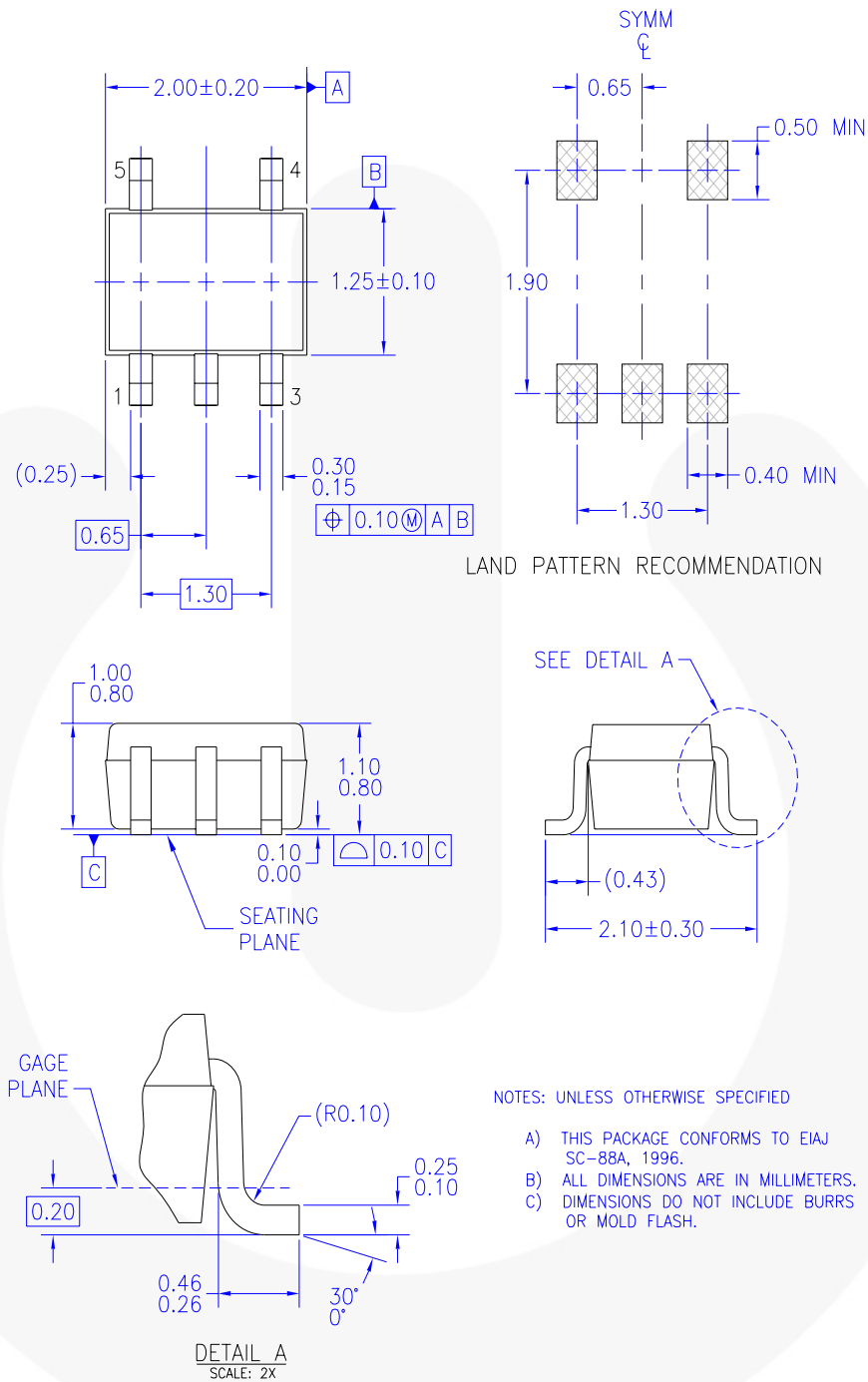

Figure 32. 5-Lead SOT-23 Package

Package drawings are provided as a service to customers considering Fairchild components. Drawings may change in any manner without notice. Please note the revision and/or date on the drawing and contact a Fairchild Semiconductor representative to verify or obtain the most recent revision. Package specifications do not expand the terms of Fairchild's worldwide terms and conditions, specifically the warranty therein, which covers Fairchild products.

Always visit Fairchild Semiconductor's online packaging area for the most recent package drawings:
<http://www.fairchildsemi.com/packaging/>

Physical Dimensions



MAA05AREV5

Figure 33. 5-Lead SC70 Package

Package drawings are provided as a service to customers considering Fairchild components. Drawings may change in any manner without notice. Please note the revision and/or date on the drawing and contact a Fairchild Semiconductor representative to verify or obtain the most recent revision. Package specifications do not expand the terms of Fairchild's worldwide terms and conditions, specifically the warranty therein, which covers Fairchild products.

Always visit Fairchild Semiconductor's online packaging area for the most recent package drawings:
<http://www.fairchildsemi.com/packaging/>

Physical Dimensions

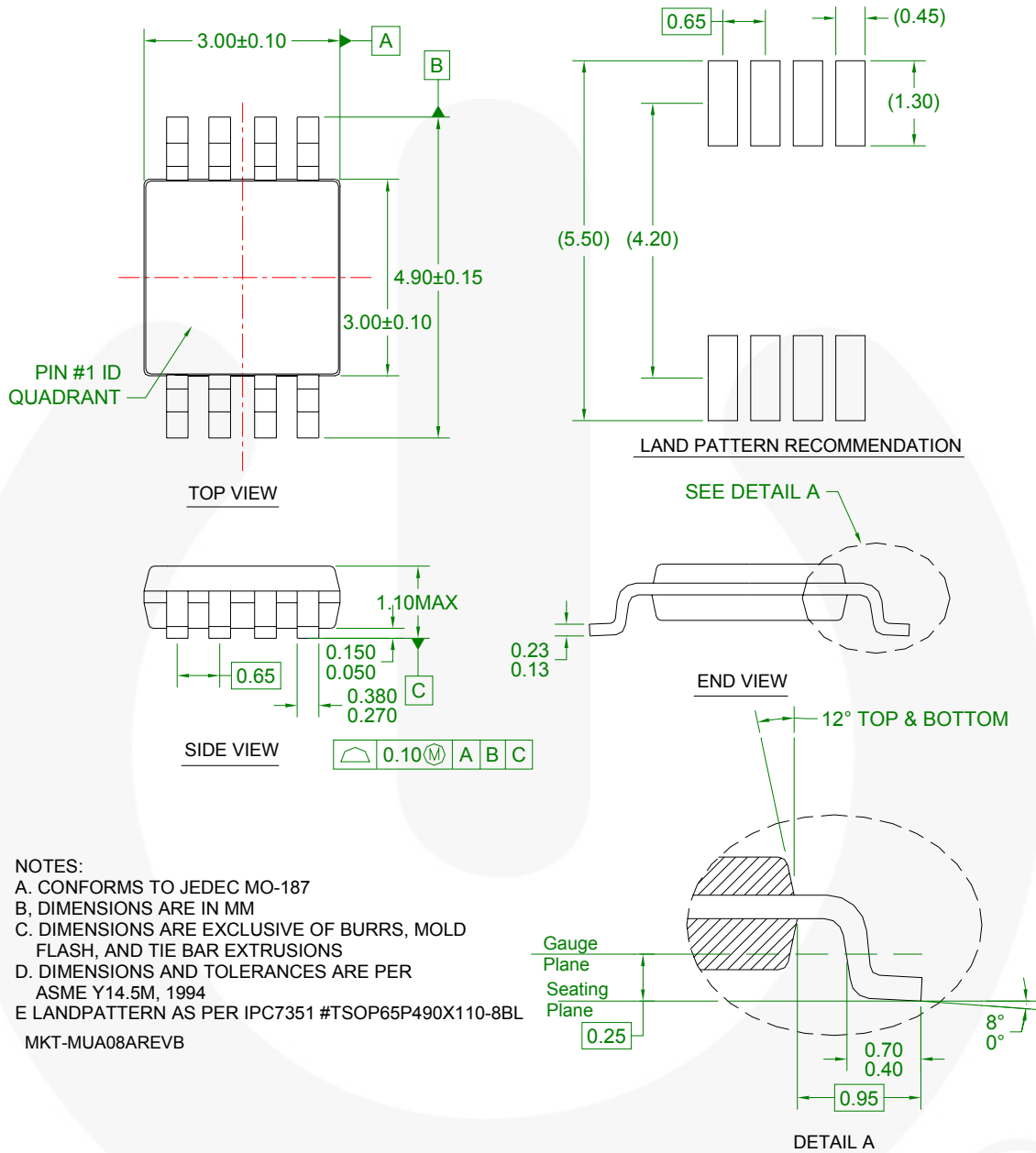

Figure 34. 8-Lead Molded Small Outline Package (MSOP)

Package drawings are provided as a service to customers considering Fairchild components. Drawings may change in any manner without notice. Please note the revision and/or date on the drawing and contact a Fairchild Semiconductor representative to verify or obtain the most recent revision. Package specifications do not expand the terms of Fairchild's worldwide terms and conditions, specifically the warranty therein, which covers Fairchild products.

Always visit Fairchild Semiconductor's online packaging area for the most recent package drawings:
<http://www.fairchildsemi.com/packaging/>



TRADEMARKS

The following includes registered and unregistered trademarks and service marks, owned by Fairchild Semiconductor and/or its global subsidiaries, and is not intended to be an exhaustive list of all such trademarks.

- | | | | |
|---|---|---|---|
| ACEx [®] | FPST [™] | PDP SPM [™] | The Power Franchise [®] |
| Build it Now [™] | F-PFS [™] | Power-SPM [™] |  |
| CorePLUS [™] | FRFET [®] | PowerTrench [®] | TinyBoost [™] |
| CorePOWER [™] | Global Power Resource SM | Programmable Active Droop [™] | TinyBuck [™] |
| CROSSVOLT [™] | Green FPST [™] | QFET [®] | TinyLogic [®] |
| CTL [™] | Green FPST [™] e-Series [™] | QS [™] | TINYOPTO [™] |
| Current Transfer Logic [™] | GTO [™] | Quiet Series [™] | TinyPower [™] |
| EcoSPARK [®] | IntelliMAX [™] | RapidConfigure [™] | TinyPWM [™] |
| EfficientMax [™] | ISOPLANAR [™] | Saving our world, 1mW at a time [™] | TinyWire [™] |
| EZSWITCH [™] * | MegaBuck [™] | SmartMax [™] | μSerDes [™] |
|  | MICROCOUPLER [™] | SMART START [™] |  |
|  | MicroFET [™] | SPM [®] | UHC [®] |
| Fairchild [®] | MicroPak [™] | STEALTH [™] | Ultra FRFET [™] |
| Fairchild Semiconductor [®] | MillerDrive [™] | SuperFET [™] | UniFET [™] |
| FACT Quiet Series [™] | MotionMax [™] | SuperSOT [™] -3 | VCX [™] |
| FACT [®] | Motion-SPM [™] | SuperSOT [™] -6 | VisualMax [™] |
| FAST [®] | OPTOLOGIC [®] | SuperSOT [™] -8 | |
| FastvCore [™] | OPTOPLANAR [®] | SupreMOS [™] | |
| FlashWriter [®] * |  | SyncFET [™] | |
| | |  | |

* EZSWITCH[™] and FlashWriter[®] are trademarks of System General Corporation, used under license by Fairchild Semiconductor.

DISCLAIMER

FAIRCHILD SEMICONDUCTOR RESERVES THE RIGHT TO MAKE CHANGES WITHOUT FURTHER NOTICE TO ANY PRODUCTS HEREIN TO IMPROVE RELIABILITY, FUNCTION, OR DESIGN. FAIRCHILD DOES NOT ASSUME ANY LIABILITY ARISING OUT OF THE APPLICATION OR USE OF ANY PRODUCT OR CIRCUIT DESCRIBED HEREIN; NEITHER DOES IT CONVEY ANY LICENSE UNDER ITS PATENT RIGHTS, NOR THE RIGHTS OF OTHERS. THESE SPECIFICATIONS DO NOT EXPAND THE TERMS OF FAIRCHILD'S WORLDWIDE TERMS AND CONDITIONS, SPECIFICALLY THE WARRANTY THEREIN, WHICH COVERS THESE PRODUCTS.

LIFE SUPPORT POLICY

FAIRCHILD'S PRODUCTS ARE NOT AUTHORIZED FOR USE AS CRITICAL COMPONENTS IN LIFE SUPPORT DEVICES OR SYSTEMS WITHOUT THE EXPRESS WRITTEN APPROVAL OF FAIRCHILD SEMICONDUCTOR CORPORATION.

As used herein:

1. Life support devices or systems are devices or systems which, (a) are intended for surgical implant into the body or (b) support or sustain life, and (c) whose failure to perform when properly used in accordance with instructions for use provided in the labeling, can be reasonably expected to result in a significant injury of the user.
2. A critical component in any component of a life support, device, or system whose failure to perform can be reasonably expected to cause the failure of the life support device or system, or to affect its safety or effectiveness.

PRODUCT STATUS DEFINITIONS

Definition of Terms

Datasheet Identification	Product Status	Definition
Advance Information	Formative / In Design	This datasheet contains the design specifications for product development. Specifications may change in any manner without notice.
Preliminary	First Production	This datasheet contains preliminary data; supplementary data will be published at a later date. Fairchild Semiconductor reserves the right to make changes at any time without notice to improve design.
No Identification Needed	Full Production	This datasheet contains final specifications. Fairchild Semiconductor reserves the right to make changes at any time without notice to improve the design.
Obsolete	Not In Production	This datasheet contains specifications on a product that is discontinued by Fairchild Semiconductor. The datasheet is for reference information only.

Rev. 134