

LED Drivers for LCD Backlights

Multifunction Backlight LED Driver for Small LCD Panels (Charge Pump Type)



BD6088GUL

No.11040EAT29

●Description

BD6088GUL is "Intelligent LED Driver" that is the most suitable for the cellular phone.

It has 6LED driver for LCD Backlight and GPO 4 port.

It has ALC function, that is "Low Power Consumption System" realized.

It can be developed widely from the model high End to the model Low End.

As it has charge pump circuit for DCDC, it is no need to use coils, and it contributes to small space.

VCSP50L3(3.50mm×3.50mm 0.5mm space)

It adopts the very thin CSP package that is the most suitable for the slim phone.

●Functions

- 1) Total 6LEDs driver for LCD Backlight
 It have 4LEDs (it can select 4LED or 3LED) for exclusive use of Main and 2LEDs which can chose independent control or a main allotment by resister setting.
 "Main Group" can be controlled by Auto Luminous Control (ALC) system.
 "Main Group" can be controlled by external PWM signal.
 ON/ off and a setup of electric current are possible at the time of the independent control by the independence.
- 2) Ambient Light sensor interface
 Main backlight can be controlled by ambient brightness.
 Photo Diode, Photo Transistor, Photo IC(Linear/Logarithm) can be connected.
 Bias source for ambient light sensor, gain and offset adjustment are built in.
 LED driver current as ambient level can be customized.
- 3) Charge Pump DC/DC for LED driver
 It has x1/x1.5/ x2 mode that will be selected automatically.
 The most suitable voltage up magnification is controlled automatically by LED port voltage.
 Output voltage fixed mode function loading (3.9V/4.2V/4.5V/4.8V)
 Soft start functions, Over voltage protection (Auto-return type), Over current protection (Auto-return type) Loading
- 4) GPO 4 Port
 Open Drain output and slope control loading
- 5) Thermal shutdown
- 6) I²C BUS FS mode(max 400kHz)

*This chip is not designed to protect itself against radioactive rays.

*This material may be changed on its way to designing.

*This material is not the official specification.

●Absolute Maximum Ratings (Ta=25 °C)

Parameter	Symbol	Ratings	Unit
Maximum voltage	VMAX	7	V
Power Dissipation	Pd	1380 ^(note)	mW
Operating Temperature Range	Topr	-30 ~ +85	°C
Storage Temperature Range	Tstg	-55 ~ +150	°C

note) Power dissipation deleting is 11.04mW/°C, when it's used in over 25°C.

(It's deleting is on the board that is ROHM's standard)

●Operating conditions (VBAT≥VIO, Ta=-35~85 °C)

Parameter	Symbol	Ratings	Unit
VBAT input voltage	VBAT	2.7 ~ 5.5	V
VIO pin voltage	VIO	1.65 ~ 3.3	V

●Electrical Characteristics (Unless otherwise specified, Ta=25°C, VBAT=3.6V, VIO=2.6V)

Parameter	Symbol	Limits			Unit	Condition
		Min.	Typ.	Max.		
【Circuit Current】						
VBAT Circuit current 1	IBAT1	-	0.1	3.0	μA	RESETB=0V, VIO= 0V
VBAT Circuit current 2	IBAT2	-	0.5	3.0	μA	RESETB=0V, VIO=2.6V
VBAT Circuit current 3	IBAT3	-	61	65	mA	DC/DC x1 mode, Io=60mA VBAT=4.0V
VBAT Circuit current 4	IBAT4	-	92	102	mA	DC/DC x1.5 mode, Io=60mA VBAT=3.6V
VBAT Circuit current 5	IBAT5	-	123	140	mA	DC/DC x2 mode, Io=60mA VBAT=2.7V
VBAT Circuit current 6	IBAT6	-	0.25	1.0	mA	ALC Operating ALCEN=1, AD cycle=0.5s setting Except sensor current
【LED Driver】						
LED current Step (Setup)	ILEDSTP1	128			Step	LED1~6
LED current Step (At slope)	ILEDSTP2	256			Step	LED1~6
LED Maximum setup current	IMAXWLED	-	25.6	-	mA	LED1~6
LED current accuracy	IWLED	-7%	15	+7%	mA	I _{LED} =15mA setting, VLED=1.0V
LED current Matching	ILEDMT	-	-	4	%	Between LED1~6 at VLED=1.0V, ILED=15mA
LED OFF Leak current	ILKLED	-	-	1.0	μA	VLED=4.5V
【DC/DC(Charge Pump)】						
Output Voltage 1	VoCP1	-	Vf+0.2	Vf+0.25	V	Vf is forward direction of LED
Output Voltage 2	VoCP2	3.705	3.9	4.095	V	Fixation Voltage Output Modelo=60mA VBAT ≥ 3.2V
		3.99	4.2	4.41	V	
		4.275	4.5	4.725	V	
		4.56	4.8	5.04	V	
Drive ability	IOUT	-	-	150	mA	VBAT ≥ 3.2V, VOUT=3.9V
Switching frequency	fosc	0.8	1.0	1.2	MHz	
Over Voltage Protection detect voltage	OVP	-	6.0	6.5	V	
Over Current Protection detect Current	OCP	-	250	375	mA	VOUT=0V
【Sensor Interface】						
SBIAS Output Voltage	VoS	2.85	3.0	3.15	V	Io=200μA
		2.47	2.6	2.73	V	Io=200μA
SBIAS Maximum Output current	IomaxS	30	-	-	mA	Vo=2.6V setting
SBIAS Discharge resister at OFF	ROFFS	-	1.0	1.5	kΩ	
SSENS Input range	VISS	0	-	VoS × 255/256	V	
ADC resolution	ADRES	8			bit	
ADC integral calculus non-linearity	ADINL	-3	-	+3	LSB	
ADC differential calculus non-linearity	ADDNL	-1	-	+1	LSB	

●Electrical Characteristics (Unless otherwise specified, Ta=25°C, VBAT=3.6V, VIO=2.6V)

Parameter	Symbol	Limits			Unit	Condition
		Min.	Typ.	Max.		
【SDA, SCL】 (I²C Interface)						
L level input voltage	VILI	-0.3	-	0.25 × VIO	V	
H level input voltage	VIHI	0.75 × VIO	-	VBAT +0.3	V	
Hysteresis of Schmitt trigger input	Vhysl	0.05 × VIO	-	-	V	
L level output voltage	VOLI	0	-	0.3	V	SDA Pin, IOL=3 mA
Input current	linl	-	-	1	μA	Input Voltage = 0.1×VIO~0.9×VIO
【RESETB】 (CMOS Input Pin)						
L level input voltage	VILR	-0.3	-	0.25 × VIO	V	
H level input voltage	VIHR	0.75 × VIO	-	VBAT +0.3	V	
Input current	linR	-	-	1	μA	Input Voltage = 0.1×VIO~0.9×VIO
【WPWMIN】 (NMOS Input Pin)						
L level input voltage	VILA	-0.3	-	0.3	V	
H level input voltage	VIHA	1.4	-	VBAT +0.3	V	
Input Current	linA	-	-	1	μA	Input Voltage = 0.1×VBAT~0.9×VBAT
PWM input minimum High pulse width	PWmin	80	-	-	μs	WPWMIN Pin
【OUTCNT】 (Pull-down resistance NMOS Input Pin)						
L level input voltage	VILA	-0.3	-	0.3	V	
H level input voltage	VIHA	1.4	-	VBAT +0.3	V	
Input Current	linA	-	3.6	10	μA	Vin=1.8V
【OUT1~4】 (NMOS Open Drain Output Pin)						
L level output voltage	VOLG	-	-	0.3	V	IOL=10mA
Output Leak current	ILKG	-	-	1.0	μA	Vout=3.6V
【GC1, GC2】 (Sensor Gain Control CMOS Output Pin)						
L level output voltage	VOLS	-	-	0.2	V	IOL=1mA
H level output voltage	VOHS	VoS -0.2	-	-	V	IOH=1mA
【KBLT】 (Key Back Light Control CMOS Output Pin)						
L level output voltage	VOLK	-	-	0.2	V	IOL=1mA
H level output voltage	VOHK	VIO -0.2	-	-	V	IOH=1mA
Pull-downresistance	RPUDK	-	1.0	2.0	MΩ	Vin=3.3V

●Block Diagram / Application Circuit example 1

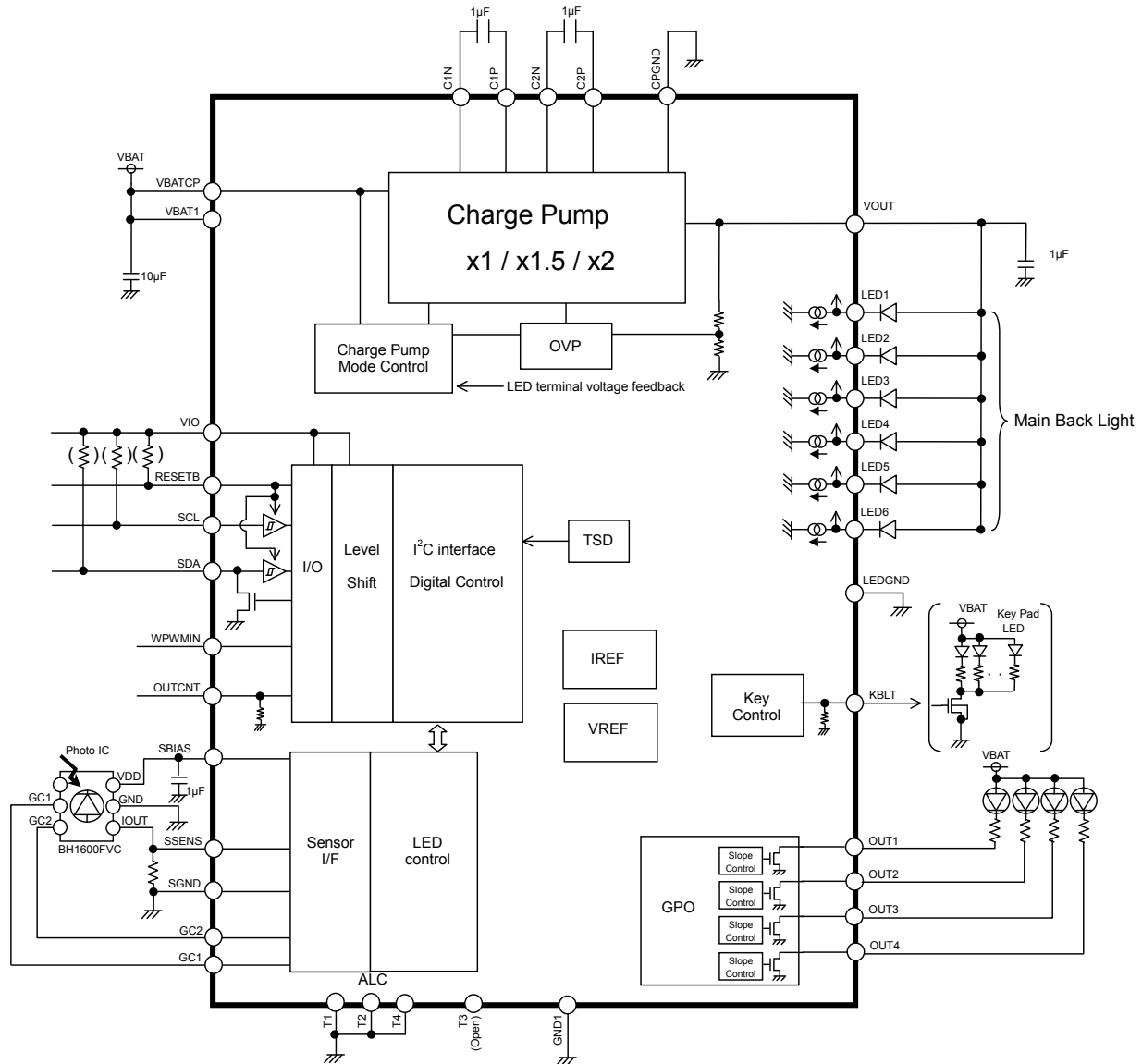

Fig.1 Block Diagram / Application Circuit example 1

●Block Diagram / Application Circuit example 2

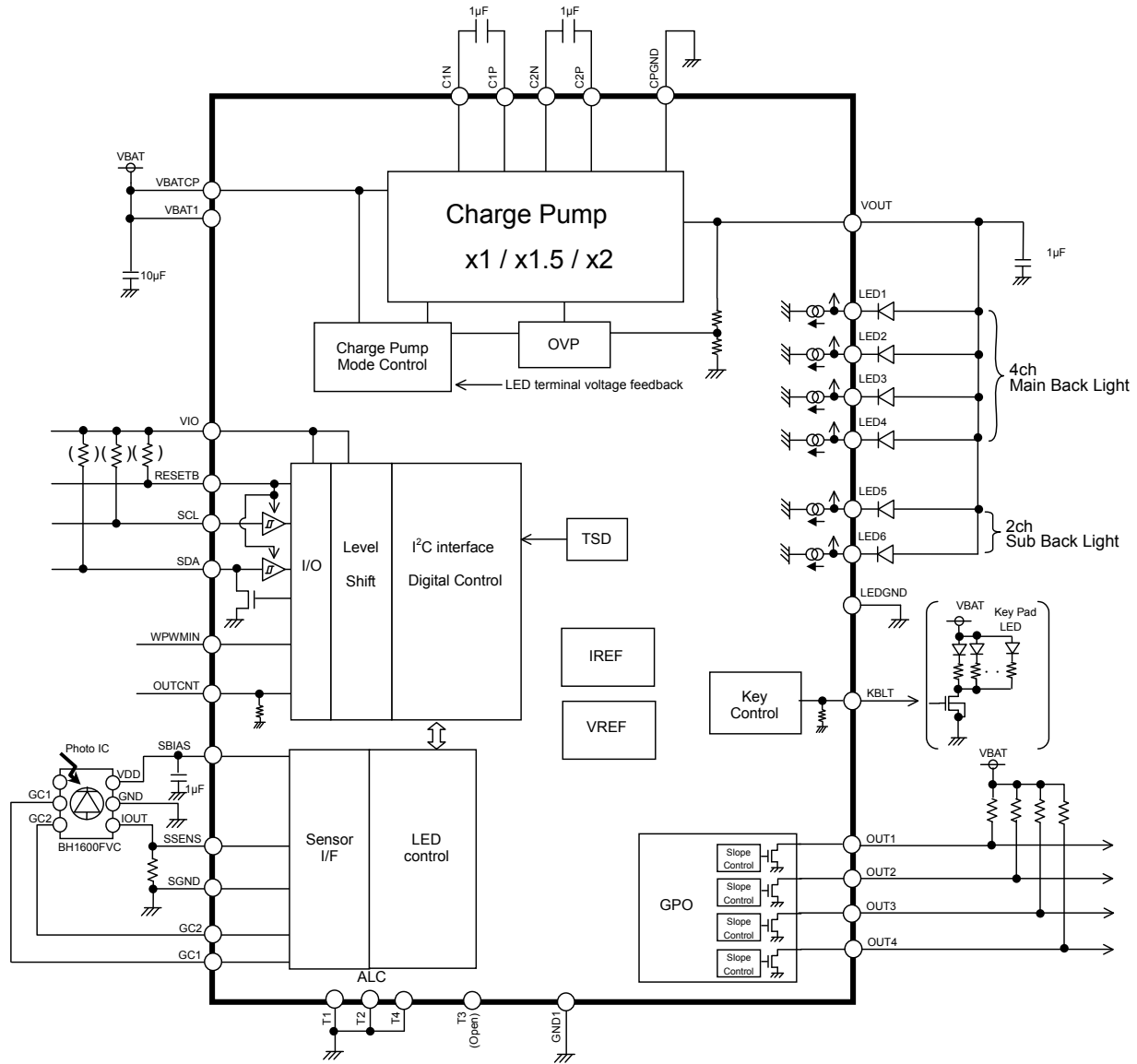
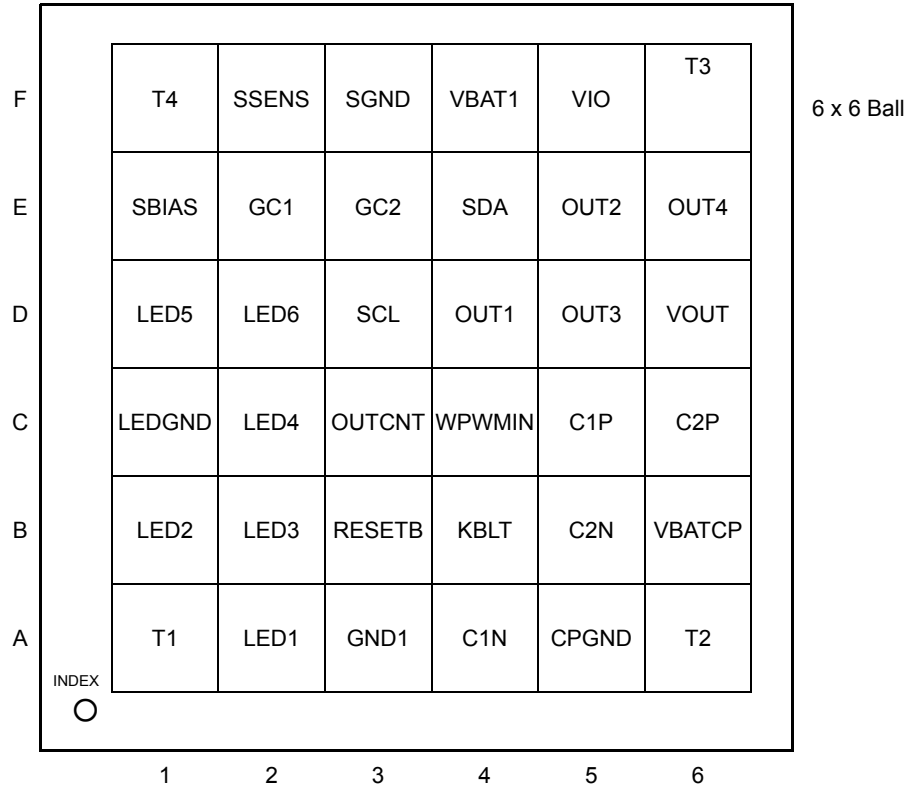

Fig.2 Block Diagram / Application Circuit example 2

●Pin Arrangement [Bottom View]



●Package

VCSP50L3 CSP small package

SIZE : 3.50mm×3.50mm(A difference in public : X,Y Both ±0.05mm) Height : 0.55mm max
 A ball pitch : 0.5 mm²

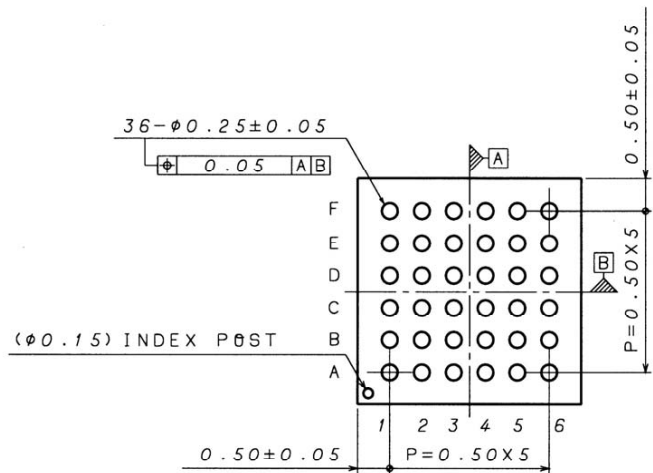
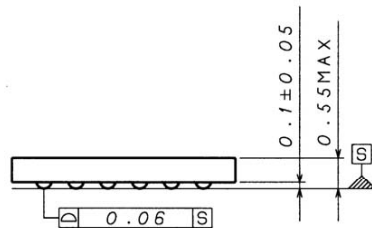
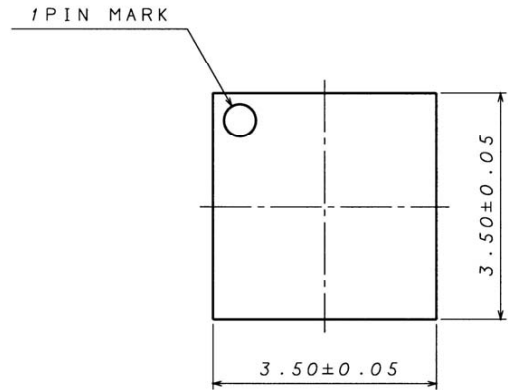

(UNIT : mm)

● Pin Functions

No	Ball No.	Pin Name	I/O	ESD Diode		Functions	Equivalent Circuit
				For Power	For Ground		
1	B6	VBATCP	-	-	GND	Battery is connected	A
2	F4	VBAT1	-	-	GND	Battery is connected	A
3	A1	T1	I	VBAT	-	Test Ground Pin(short to Ground)	B
4	A6	T2	I	VBAT	GND	Test Input Pin (short to Ground)	S
5	F6	T3	O	VBAT	GND	Test Output Pin(Open)	M
6	F1	T4	I	VBAT	GND	Test Input Pin (short to Ground)	S
7	F5	VIO	-	VBAT	GND	I/O Power supply is connected	C
8	B3	RESETB	I	VBAT	GND	Reset input (L: reset, H: reset cancel)	H
9	E4	SDA	I/O	VBAT	GND	I ² C data input / output	I
10	D3	SCL	I	VBAT	GND	I ² C clock input	H
11	A5	CPGND	-	VBAT	-	Ground	B
12	A3	GND1	-	VBAT	-	Ground	B
13	C1	LEDGND	-	VBAT	-	Ground	B
14	A4	C1N	I/O	VBAT	GND	Charge Pump capacitor is connected	F
15	C5	C1P	I/O	-	GND	Charge Pump capacitor is connected	G
16	B5	C2N	I/O	VBAT	GND	Charge Pump capacitor is connected	F
17	C6	C2P	I/O	-	GND	Charge Pump capacitor is connected	G
18	D6	VOUT	O	-	GND	Charge Pump output pin	A
19	A2	LED1	I	-	GND	LED is connected 1 for LCD Back Light	E
20	B1	LED2	I	-	GND	LED is connected 2 for LCD Back Light	E
21	B2	LED3	I	-	GND	LED is connected 3 for LCD Back Light	E
22	C2	LED4	I	-	GND	LED is connected 4 for LCD Back Light	E
23	D1	LED5	I	-	GND	LED is connected 5 for LCD Back Light	E
24	D2	LED6	I	-	GND	LED is connected 6 for LCD Back Light	E
25	E1	SBIAS	O	VBAT	GND	Bias output for the Ambient Light Sensor	Q
26	F2	SSENS	I	VBAT	GND	Ambient Light Sensor input	N
27	E2	GC1	O	VBAT	GND	Ambient Light Sensor gain control output 1	X
28	E3	GC2	O	VBAT	GND	Ambient Light Sensor gain control output 2	X
29	F3	SGND	-	VBAT	-	Ground	B
30	D4	OUT1	O	-	GND	General Output Port 1	U
31	E5	OUT2	O	-	GND	General Output Port 1	U
32	D5	OUT3	O	-	GND	General Output Port 1	U
33	E6	OUT4	O	-	GND	General Output Port 1	U
34	C4	WPWMIN	I	VBAT	GND	External PWM input for Back Light *	V
35	C3	OUTCNT	I	VBAT	GND	OUT1,2,3,4 Output Control (L:OFF) *	L
36	B4	KBLT	O	VBAT	GND	Key Back Light Control Output	W

* A setup of a register is separately necessary to make it effective.

●Equivalent Circuit

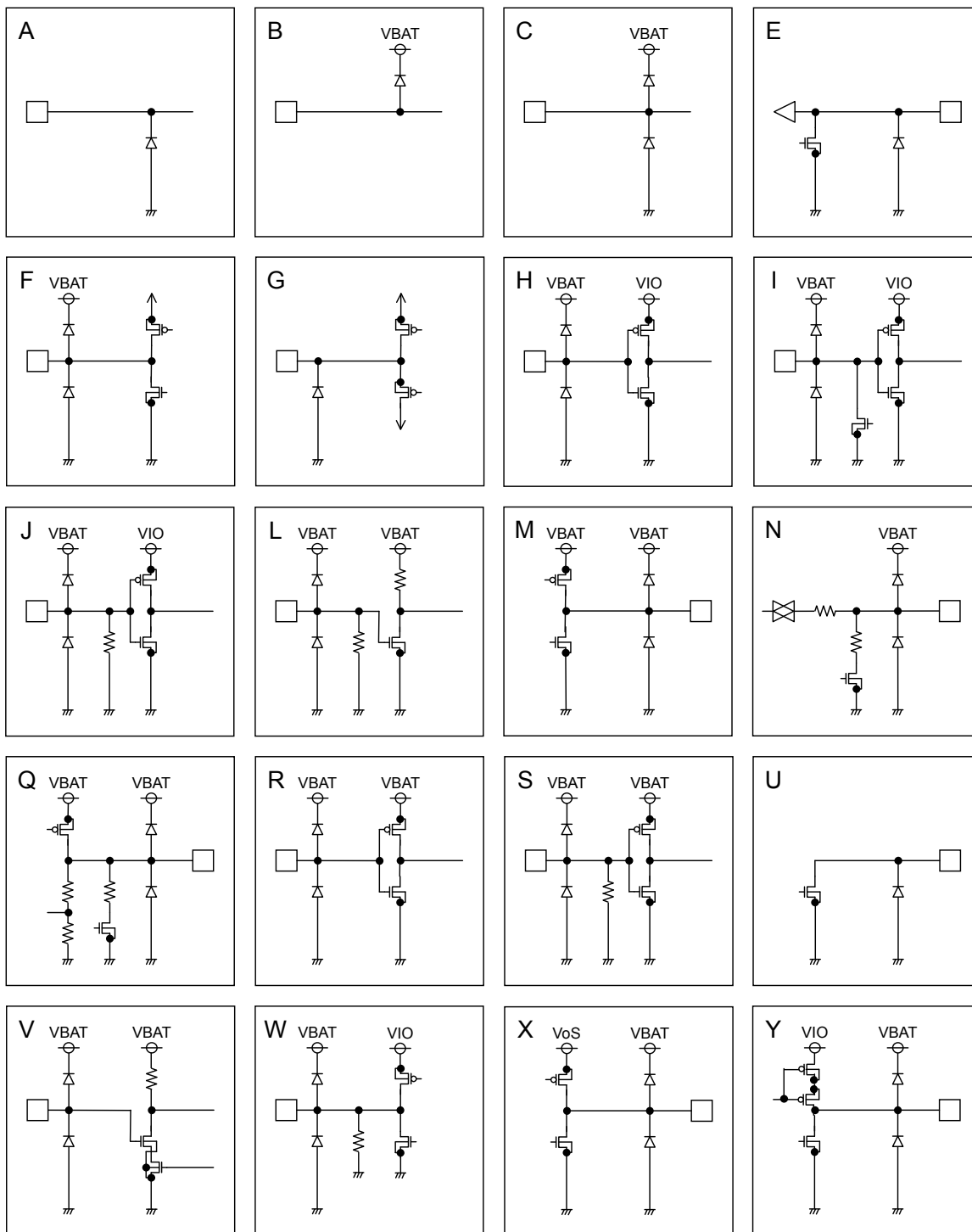

● I²C BUS format

The writing/reading operation is based on the I²C slave standard.

• Slave address

A7	A6	A5	A4	A3	A2	A1	R/W
1	1	1	0	1	1	0	1/0

• Bit Transfer

SCL transfers 1-bit data during H. SCL cannot change signal of SDA during H at the time of bit transfer. If SDA changes while SCL is H, START conditions or STOP conditions will occur and it will be interpreted as a control signal.

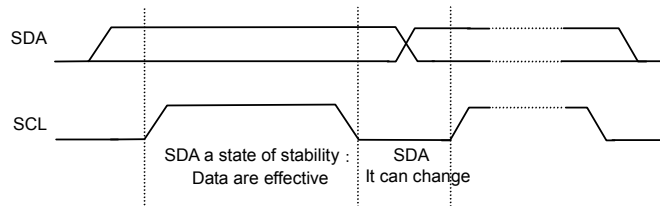

• START and STOP condition

When SDA and SCL are H, data is not transferred on the I²C- bus. This condition indicates, if SDA changes from H to L while SCL has been H, it will become START (S) conditions, and an access start, if SDA changes from L to H while SCL has been H, it will become STOP (P) conditions and an access end.

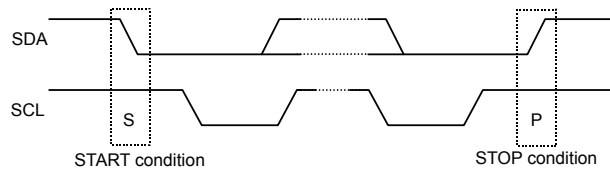

• Acknowledge

It transfers data 8 bits each after the occurrence of START condition. A transmitter opens SDA after transfer 8bits data, and a receiver returns the acknowledge signal by setting SDA to L.

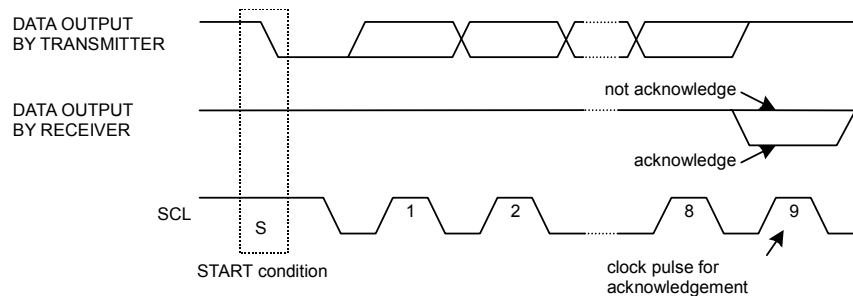

• Writing protocol

A register address is transferred by the next 1 byte that transferred the slave address and the write-in command. The 3rd byte writes data in the internal register written in by the 2nd byte, and after 4th byte or, the increment of register address is carried out automatically. However, when a register address turns into the last address, it is set to 00h by the next transmission. After the transmission end, the increment of the address is carried out.

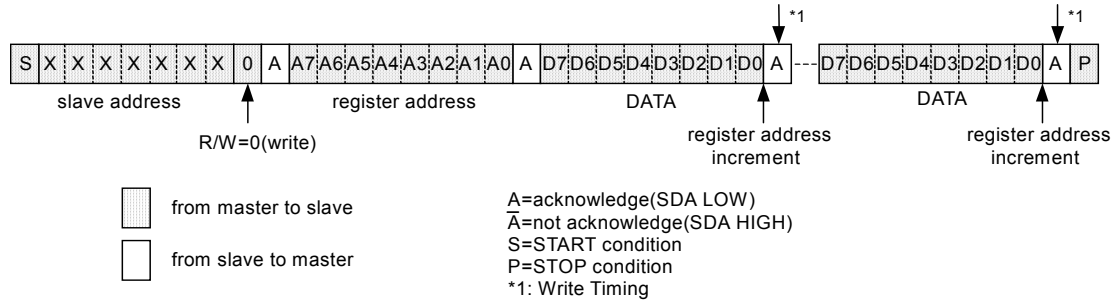

• Reading protocol

It reads from the next byte after writing a slave address and R/W bit. The register to read considers as the following address accessed at the end, and the data of the address that carried out the increment is read after it. If an address turns into the last address, the next byte will read out 00h. After the transmission end, the increment of the address is carried out.

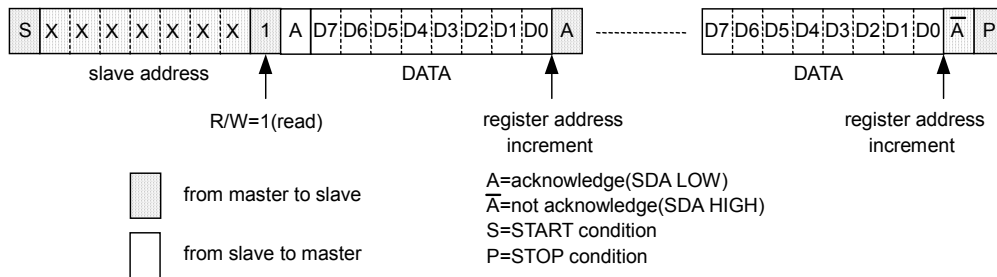

• Multiple reading protocols

After specifying an internal address, it reads by repeated START condition and changing the data transfer direction. The data of the address that carried out the increment is read after it. If an address turns into the last address, the next byte will read out 00h. After the transmission end, the increment of the address is carried out.

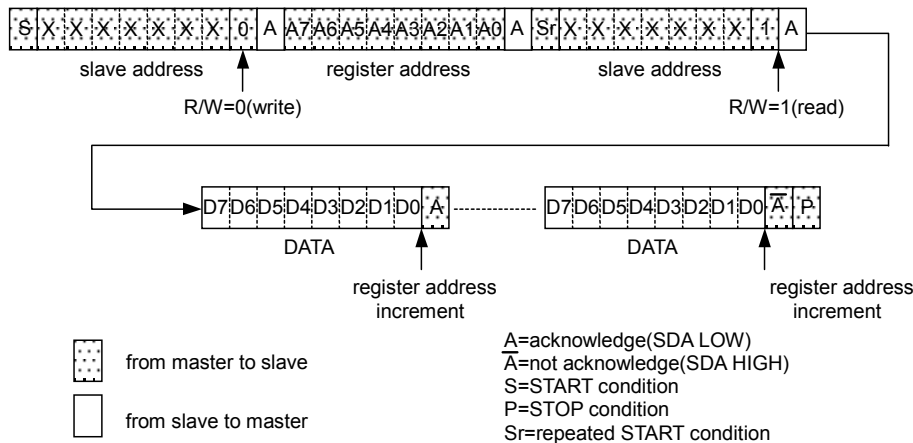

As for reading protocol and multiple reading protocols, please do \bar{A} (not acknowledge) after doing the final reading operation. It stops with read when ending by A(acknowledge), and SDA stops in the state of Low when the reading data of that time is 0. However, this state returns usually when SCL is moved, data is read, and A(not acknowledge) is done.

● Timing diagram

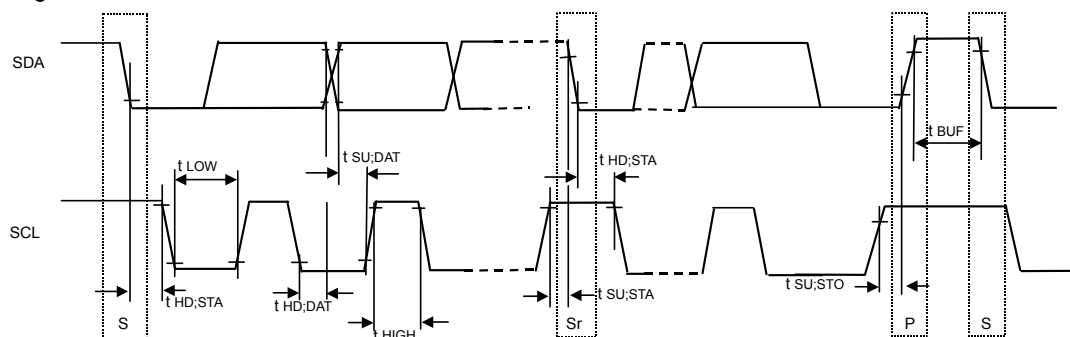

● Electrical Characteristics (Unless otherwise specified, Ta=25 °C, VBAT=3.6V, VIO=2.6V)

Parameter	Symbol	Standard-mode			Fast-mode			Unit
		Min.	Typ.	Max.	Min.	Typ.	Max.	
【I²C BUS format】								
SCL clock frequency	fSCL	0	-	100	0	-	400	kHz
LOW period of the SCL clock	t _{LOW}	4.7	-	-	1.3	-	-	μs
HIGH period of the SCL clock	t _{HIGH}	4.0	-	-	0.6	-	-	μs
Hold time (repeated) START condition After this period, the first clock is generated	t _{HD;STA}	4.0	-	-	0.6	-	-	μs
Set-up time for a repeated START condition	t _{SU;STA}	4.7	-	-	0.6	-	-	μs
Data hold time	t _{HD;DAT}	0	-	3.45	0	-	0.9	μs
Data set-up time	t _{SU;DAT}	250	-	-	100	-	-	ns
Set-up time for STOP condition	t _{SU;STO}	4.0	-	-	0.6	-	-	μs
Bus free time between a STOP and START condition	t _{BUF}	4.7	-	-	1.3	-	-	μs

● Register List

Address	W/R	Register data								Function
		D7	D6	D5	D4	D3	D2	D1	D0	
00h	W	VOUT(1)	VOUT(0)	DCDCMD	DCDCFON	-	-	-	SFTRST	Software Reset DC/DC function setting
01h	W	WPWMEN	WPWMPOL	-	-	W6MD	W5MD	W4MD	MLEDMD	LED Pin function setting
02h	W/R	-	-	-	-	ALCEN	W6EN	W5EN	MLEDEN	Power Control
03h	W	-	IMLED(6)	IMLED(5)	IMLED(4)	IMLED(3)	IMLED(2)	IMLED(1)	IMLED(0)	Main group current setting
04h	W	-	IW5(6)	IW5(5)	IW5(4)	IW5(3)	IW5(2)	IW5(1)	IW5(0)	LED5 current setting
05h	W	-	IW6(6)	IW6(5)	IW6(4)	IW6(3)	IW6(2)	IW6(1)	IW6(0)	LED6 current setting
06h	W	THL (3)	THL (2)	THL (1)	THL (0)	TLH (3)	TLH (2)	TLH (1)	TLH (0)	Main Current transition
07h	W	ADCYC (1)	ADCYC (0)	GAIN (1)	GAIN(0)	STYPE	VSB	MDCIR	SBIASON	Measurement mode setting
08h	W	SOFS (3)	SOFS (2)	SOFS (1)	SOFS (0)	SGAIN (3)	SGAIN (2)	SGAIN (1)	SGAIN (0)	Measurement data adjustment
09h	R	-	-	-	-	AMB (3)	AMB (2)	AMB (1)	AMB (0)	Ambient level
0Ah	W	-	IU0 (6)	IU0 (5)	IU0 (4)	IU0 (3)	IU0 (2)	IU0 (1)	IU0 (0)	LED Current at Ambient level 0h
0Bh	W	-	IU1 (6)	IU1 (5)	IU1 (4)	IU1 (3)	IU1 (2)	IU1 (1)	IU1 (0)	LED Current at Ambient level 1h
0Ch	W	-	IU2 (6)	IU2 (5)	IU2 (4)	IU2 (3)	IU2 (2)	IU2 (1)	IU2 (0)	LED Current at Ambient level 2h
0Dh	W	-	IU3 (6)	IU3 (5)	IU3 (4)	IU3 (3)	IU3 (2)	IU3 (1)	IU3 (0)	LED Current at Ambient level 3h
0Eh	W	-	IU4 (6)	IU4 (5)	IU4 (4)	IU4 (3)	IU4 (2)	IU4 (1)	IU4 (0)	LED Current at Ambient level 4h
0Fh	W	-	IU5 (6)	IU5 (5)	IU5 (4)	IU5 (3)	IU5 (2)	IU5 (1)	IU5 (0)	LED Current at Ambient level 5h
10h	W	-	IU6 (6)	IU6 (5)	IU6 (4)	IU6 (3)	IU6 (2)	IU6 (1)	IU6 (0)	LED Current at Ambient level 6h
11h	W	-	IU7 (6)	IU7 (5)	IU7 (4)	IU7 (3)	IU7 (2)	IU7 (1)	IU7 (0)	LED Current at Ambient level 7h
12h	W	-	IU8 (6)	IU8 (5)	IU8 (4)	IU8 (3)	IU8 (2)	IU8 (1)	IU8 (0)	LED Current at Ambient level 8h
13h	W	-	IU9 (6)	IU9 (5)	IU9 (4)	IU9 (3)	IU9 (2)	IU9 (1)	IU9 (0)	LED Current at Ambient level 9h
14h	W	-	IUA (6)	IUA (5)	IUA (4)	IUA (3)	IUA (2)	IUA (1)	IUA (0)	LED Current at Ambient level Ah
15h	W	-	IUB (6)	IUB (5)	IUB (4)	IUB (3)	IUB (2)	IUB (1)	IUB (0)	LED Current at Ambient level Bh
16h	W	-	IUC (6)	IUC (5)	IUC (4)	IUC (3)	IUC (2)	IUC (1)	IUC (0)	LED Current at Ambient level Ch
17h	W	-	IUD (6)	IUD (5)	IUD (4)	IUD (3)	IUD (2)	IUD (1)	IUD (0)	LED Current at Ambient level Dh
18h	W	-	IUE (6)	IUE (5)	IUE (4)	IUE (3)	IUE (2)	IUE (1)	IUE (0)	LED Current at Ambient level Eh
19h	W	-	IUF (6)	IUF (5)	IUF (4)	IUF (3)	IUF (2)	IUF (1)	IUF (0)	LED Current at Ambient level Fh
1Ah	W	-	-	CHYS (1)	CHYS (0)	CTH (3)	CTH (2)	CTH (1)	CTH (0)	Key driver 2 Value judging control setup
1Bh	W	-	-	-	KBMD	OUT4MD	OUT3MD	OUT2MD	OUT1MD	OUT, KBLT Output Mode setting
1Ch	W/R	-	-	-	KBEN	OUT4EN	OUT3EN	OUT2EN	OUT1EN	OUT, KBLT Output Control
1Dh	W	FPWM	-	-	-	KBSLP(1)	KBSLP(0)	OUTSLP(1)	OUTSLP(0)	OUT, KBLT Slope setting

Input "0" for "-".

A free address has the possibility to assign it to the register for the test.

Access to the register for the test and the undefined register is prohibited.

●Register Map

Address 00h < Software Reset , DC/DC function setting >

Address	R/W	Bit7	Bit6	Bit5	Bit4	Bit3	Bit2	Bit1	Bit0
00h	W	VOUT(1)	VOUT(0)	DCDCMD	DCDCFON	-	-	-	SFTRST
Initial Value	00h	0	0	0	0	-	-	-	0

Bit [7:6] : **VOUT (1:0)** VOUT Output Voltage setting

“00” : VOUT Output Voltage 3.9V

“01” : VOUT Output Voltage 4.2V

“10” : VOUT Output Voltage 4.5V

“11” : VOUT Output Voltage 4.8V

Bit [5:4] : **DCDCMD, DCDCFON** DC/DC setting

<DC/DC Return Mode>

“00” : LED Pin Return

“01” : LEDPin Return

“10” : Output Voltage Fixation

“11” : Output Voltage Fixation

<DC/DC ON/OFF Control>

Depend on LED ON/OFF

Depend on LED ON/OFF

Depend on LED ON/OFF

Compulsion ON

Bit [3:1] : (Not used)

Bit0 : **SFTRST** Software Reset

“0” : Reset cancel

“1” : Reset(All register initializing)

Refer to “The explanation of Reset” for detail.

Address 01h < LED Pin function setting >

Address	R/W	Bit7	Bit6	Bit5	Bit4	Bit3	Bit2	Bit1	Bit0
01h	W	WPWMEN	WPWMPOL	-	-	W6MD	W5MD	W4MD	MLEDMD
Initial Value	42h	0	1	-	-	0	0	1	0

Bit7 : **WPWMEN** External PWM Input "WPWMIN" terminal Enable Control (Valid/Invalid)

"0" : External PWM input invalid

"1" : External PWM input valid

Refer to "(11) Current Adjustment" of "The explanation of ALC" for detail.

Bit6 : **WPWMPOL** Polarity setting of External PWM input "WPWMIN" terminal

"0" : External PWM 'L' drive

"1" : External PWM 'H' drive

Refer to "(11) Current Adjustment" of "The explanation of ALC" for detail.

Bit [5:4] : (Not used)

Bit3 : **W6MD** LED6 control setting (individual / Main group)

"0" : LED6 individual control

"1" : LED6 Main group control

Refer to "LED Driver" for detail.

Bit2 : **W5MD** LED5 control setting (individual / Main group)

"0" : LED5 individual control

"1" : LED5 Use (Main group)

Refer to "LED Driver" for detail.

Bit1 : **W4MD** LED4 movement setting (unuse / use)

"0" : LED4 unuse

"1" : LED4 use (Main group Control)

Refer to "LED Driver" for detail.

Bit0 : **MLEDMD** Main group setting (Normal / ALC)

"0" : Main group Normal Mode(ALCNon-reflection)

"1" : Main group ALC Mode

Refer to "(1) Auto Luminous Control ON/OFF" of "The explanation of ALC" for detail.

Set up a fixation in every design because it isn't presumed W*PW that it is changed dynamically.
And, do the setup of W*PW when each LED is Off.

Address 02h < Power Control >

Address	R/W	Bit7	Bit6	Bit5	Bit4	Bit3	Bit2	Bit1	Bit0
02h	W/R	-	-	-	-	ALCEN	W6EN	W5EN	MLEDEN
Initial Value	00h	-	-	-	-	0	0	0	0

Bit [7:4] : (Not used)

Bit3 : **ALCEN** ALC function Control (ON/OFF)
 "0" : ALC block OFF
 "1" : ALC block ON (Ambient Measurement)

Bit2 : **W6EN** LED6 Control (ON/OFF)
 "0" : LED6 OFF
 "1" : LED6 ON(individual control)

Bit1 : **W5EN** LED5 Control (ON/OFF)
 "0" : LED5 OFF
 "1" : LED5 ON(individual control)

Bit0 : **MLEDEN** Main group LED Control (ON/OFF)
 "0" : Main group OFF
 "1" : Main group ON

Address 03h < Main group LED Current setting(Normal Mode) >

Address	R/W	Bit7	Bit6	Bit5	Bit4	Bit3	Bit2	Bit1	Bit0
03h	W	-	IMLED(6)	IMLED(5)	IMLED(4)	IMLED(3)	IMLED(2)	IMLED(1)	IMLED(0)
Initial Value	00h	-	0	0	0	0	0	0	0

Bit7 : (Not used)

Bit [6:0] : **IMLED (6:0)** Main Group LED Current Setting at non-ALC mode

"000000" : 0.2 mA	"100000" : 13.0 mA
"000001" : 0.4 mA	"100001" : 13.2 mA
"000010" : 0.6 mA	"100010" : 13.4 mA
"000011" : 0.8 mA	"100011" : 13.6 mA
"000100" : 1.0 mA	"100100" : 13.8 mA
"000101" : 1.2 mA	"100101" : 14.0 mA
"000110" : 1.4 mA	"100110" : 14.2 mA
"000111" : 1.6 mA	"100111" : 14.4 mA
"001000" : 1.8 mA	"100100" : 14.6 mA
"001001" : 2.0 mA	"100101" : 14.8 mA
"001010" : 2.2 mA	"100110" : 15.0 mA
"001011" : 2.4 mA	"100111" : 15.2 mA
"001100" : 2.6 mA	"100100" : 15.4 mA
"001101" : 2.8 mA	"100101" : 15.6 mA
"001110" : 3.0 mA	"100110" : 15.8 mA
"001111" : 3.2 mA	"100111" : 16.0 mA
"010000" : 3.4 mA	"101000" : 16.2 mA
"010001" : 3.6 mA	"101001" : 16.4 mA
"010010" : 3.8 mA	"101010" : 16.6 mA
"010011" : 4.0 mA	"101011" : 16.8 mA
"010100" : 4.2 mA	"101000" : 17.0 mA
"010101" : 4.4 mA	"101001" : 17.2 mA
"010110" : 4.6 mA	"101010" : 17.4 mA
"010111" : 4.8 mA	"101011" : 17.6 mA
"011000" : 5.0 mA	"101000" : 17.8 mA
"011001" : 5.2 mA	"101001" : 18.0 mA
"011010" : 5.4 mA	"101010" : 18.2 mA
"011011" : 5.6 mA	"101011" : 18.4 mA
"011100" : 5.8 mA	"101100" : 18.6 mA
"011101" : 6.0 mA	"101101" : 18.8 mA
"011110" : 6.2 mA	"101110" : 19.0 mA
"011111" : 6.4 mA	"101111" : 19.2 mA
"100000" : 6.6 mA	"110000" : 19.4 mA
"100001" : 6.8 mA	"110001" : 19.6 mA
"100010" : 7.0 mA	"110010" : 19.8 mA
"100011" : 7.2 mA	"110011" : 20.0 mA
"100100" : 7.4 mA	"110000" : 20.2 mA
"100101" : 7.6 mA	"110001" : 20.4 mA
"100110" : 7.8 mA	"110010" : 20.6 mA
"100111" : 8.0 mA	"110011" : 20.8 mA
"101000" : 8.2 mA	"110000" : 21.0 mA
"101001" : 8.4 mA	"110001" : 21.2 mA
"101010" : 8.6 mA	"110010" : 21.4 mA
"101011" : 8.8 mA	"110011" : 21.6 mA
"101100" : 9.0 mA	"110000" : 21.8 mA
"101101" : 9.2 mA	"110001" : 22.0 mA
"101110" : 9.4 mA	"110010" : 22.2 mA
"101111" : 9.6 mA	"110011" : 22.4 mA
"110000" : 9.8 mA	"110000" : 22.6 mA
"110001" : 10.0 mA	"110001" : 22.8 mA
"110010" : 10.2 mA	"110010" : 23.0 mA
"110011" : 10.4 mA	"110011" : 23.2 mA
"110100" : 10.6 mA	"110000" : 23.4 mA
"110101" : 10.8 mA	"110001" : 23.6 mA
"110110" : 11.0 mA	"110010" : 23.8 mA
"110111" : 11.2 mA	"110011" : 24.0 mA
"111000" : 11.4 mA	"110000" : 24.2 mA
"111001" : 11.6 mA	"110001" : 24.4 mA
"111010" : 11.8 mA	"110010" : 24.6 mA
"111011" : 12.0 mA	"110011" : 24.8 mA
"111100" : 12.2 mA	"110000" : 25.0 mA
"111101" : 12.4 mA	"110001" : 25.2 mA
"111110" : 12.6 mA	"110010" : 25.4 mA
"111111" : 12.8 mA	"110011" : 25.6 mA

Address 04h < LED5 Current setting(Independence control) >

Address	R/W	Bit7	Bit6	Bit5	Bit4	Bit3	Bit2	Bit1	Bit0
04h	W	-	IW5(6)	IW5(5)	IW5(4)	IW5(3)	IW5(2)	IW5(1)	IW5(0)
Initial Value	00h	-	0	0	0	0	0	0	0

Bit7 : (Not used)

Bit [6:0] : **IW5 (6:0)** LED5 Current setting

"000000" : 0.2 mA	"1000000" : 13.0 mA
"0000001" : 0.4 mA	"1000001" : 13.2 mA
"0000010" : 0.6 mA	"1000010" : 13.4 mA
"0000011" : 0.8 mA	"1000011" : 13.6 mA
"0000100" : 1.0 mA	"1000100" : 13.8 mA
"0000101" : 1.2 mA	"1000101" : 14.0 mA
"0000110" : 1.4 mA	"1000110" : 14.2 mA
"0000111" : 1.6 mA	"1000111" : 14.4 mA
"0001000" : 1.8 mA	"1001000" : 14.6 mA
"0001001" : 2.0 mA	"1001001" : 14.8 mA
"0001010" : 2.2 mA	"1001010" : 15.0 mA
"0001011" : 2.4 mA	"1001011" : 15.2 mA
"0001100" : 2.6 mA	"1001100" : 15.4 mA
"0001101" : 2.8 mA	"1001101" : 15.6 mA
"0001110" : 3.0 mA	"1001110" : 15.8 mA
"0001111" : 3.2 mA	"1001111" : 16.0 mA
"0010000" : 3.4 mA	"1010000" : 16.2 mA
"0010001" : 3.6 mA	"1010001" : 16.4 mA
"0010010" : 3.8 mA	"1010010" : 16.6 mA
"0010011" : 4.0 mA	"1010011" : 16.8 mA
"0010100" : 4.2 mA	"1010100" : 17.0 mA
"0010101" : 4.4 mA	"1010101" : 17.2 mA
"0010110" : 4.6 mA	"1010110" : 17.4 mA
"0010111" : 4.8 mA	"1010111" : 17.6 mA
"0011000" : 5.0 mA	"1011000" : 17.8 mA
"0011001" : 5.2 mA	"1011001" : 18.0 mA
"0011010" : 5.4 mA	"1011010" : 18.2 mA
"0011011" : 5.6 mA	"1011011" : 18.4 mA
"0011100" : 5.8 mA	"1011100" : 18.6 mA
"0011101" : 6.0 mA	"1011101" : 18.8 mA
"0011110" : 6.2 mA	"1011110" : 19.0 mA
"0011111" : 6.4 mA	"1011111" : 19.2 mA
"0100000" : 6.6 mA	"1100000" : 19.4 mA
"0100001" : 6.8 mA	"1100001" : 19.6 mA
"0100010" : 7.0 mA	"1100010" : 19.8 mA
"0100011" : 7.2 mA	"1100011" : 20.0 mA
"0100100" : 7.4 mA	"1100100" : 20.2 mA
"0100101" : 7.6 mA	"1100101" : 20.4 mA
"0100110" : 7.8 mA	"1100110" : 20.6 mA
"0100111" : 8.0 mA	"1100111" : 20.8 mA
"0101000" : 8.2 mA	"1101000" : 21.0 mA
"0101001" : 8.4 mA	"1101001" : 21.2 mA
"0101010" : 8.6 mA	"1101010" : 21.4 mA
"0101011" : 8.8 mA	"1101011" : 21.6 mA
"0101100" : 9.0 mA	"1101100" : 21.8 mA
"0101101" : 9.2 mA	"1101101" : 22.0 mA
"0101110" : 9.4 mA	"1101110" : 22.2 mA
"0101111" : 9.6 mA	"1101111" : 22.4 mA
"0110000" : 9.8 mA	"1110000" : 22.6 mA
"0110001" : 10.0 mA	"1110001" : 22.8 mA
"0110010" : 10.2 mA	"1110010" : 23.0 mA
"0110011" : 10.4 mA	"1110011" : 23.2 mA
"0110100" : 10.6 mA	"1110100" : 23.4 mA
"0110101" : 10.8 mA	"1110101" : 23.6 mA
"0110110" : 11.0 mA	"1110110" : 23.8 mA
"0110111" : 11.2 mA	"1110111" : 24.0 mA
"0111000" : 11.4 mA	"1111000" : 24.2 mA
"0111001" : 11.6 mA	"1111001" : 24.4 mA
"0111010" : 11.8 mA	"1111010" : 24.6 mA
"0111011" : 12.0 mA	"1111011" : 24.8 mA
"0111100" : 12.2 mA	"1111100" : 25.0 mA
"0111101" : 12.4 mA	"1111101" : 25.2 mA
"0111110" : 12.6 mA	"1111110" : 25.4 mA
"0111111" : 12.8 mA	"1111111" : 25.6 mA

Address 05h < LED6 Current setting(Independence control) >

Address	R/W	Bit7	Bit6	Bit5	Bit4	Bit3	Bit2	Bit1	Bit0
05h	W	-	IW6(6)	IW6(5)	IW6(4)	IW6(3)	IW6(2)	IW6(1)	IW6(0)
Initial Value	00h	-	0	0	0	0	0	0	0

Bit7 : (Not used)

Bit [6:0] : IW6 (6:0) LED6 Current setting

"000000" : 0.2 mA	"1000000" : 13.0 mA
"0000001" : 0.4 mA	"1000001" : 13.2 mA
"0000010" : 0.6 mA	"1000010" : 13.4 mA
"0000011" : 0.8 mA	"1000011" : 13.6 mA
"0000100" : 1.0 mA	"1000100" : 13.8 mA
"0000101" : 1.2 mA	"1000101" : 14.0 mA
"0000110" : 1.4 mA	"1000110" : 14.2 mA
"0000111" : 1.6 mA	"1000111" : 14.4 mA
"0001000" : 1.8 mA	"1001000" : 14.6 mA
"0001001" : 2.0 mA	"1001001" : 14.8 mA
"0001010" : 2.2 mA	"1001010" : 15.0 mA
"0001011" : 2.4 mA	"1001011" : 15.2 mA
"0001100" : 2.6 mA	"1001100" : 15.4 mA
"0001101" : 2.8 mA	"1001101" : 15.6 mA
"0001110" : 3.0 mA	"1001110" : 15.8 mA
"0001111" : 3.2 mA	"1001111" : 16.0 mA
"0010000" : 3.4 mA	"1010000" : 16.2 mA
"0010001" : 3.6 mA	"1010001" : 16.4 mA
"0010010" : 3.8 mA	"1010010" : 16.6 mA
"0010011" : 4.0 mA	"1010011" : 16.8 mA
"0010100" : 4.2 mA	"1010100" : 17.0 mA
"0010101" : 4.4 mA	"1010101" : 17.2 mA
"0010110" : 4.6 mA	"1010110" : 17.4 mA
"0010111" : 4.8 mA	"1010111" : 17.6 mA
"0011000" : 5.0 mA	"1011000" : 17.8 mA
"0011001" : 5.2 mA	"1011001" : 18.0 mA
"0011010" : 5.4 mA	"1011010" : 18.2 mA
"0011011" : 5.6 mA	"1011011" : 18.4 mA
"0011100" : 5.8 mA	"1011100" : 18.6 mA
"0011101" : 6.0 mA	"1011101" : 18.8 mA
"0011110" : 6.2 mA	"1011110" : 19.0 mA
"0011111" : 6.4 mA	"1011111" : 19.2 mA
"0100000" : 6.6 mA	"1100000" : 19.4 mA
"0100001" : 6.8 mA	"1100001" : 19.6 mA
"0100010" : 7.0 mA	"1100010" : 19.8 mA
"0100011" : 7.2 mA	"1100011" : 20.0 mA
"0100100" : 7.4 mA	"1100100" : 20.2 mA
"0100101" : 7.6 mA	"1100101" : 20.4 mA
"0100110" : 7.8 mA	"1100110" : 20.6 mA
"0100111" : 8.0 mA	"1100111" : 20.8 mA
"0101000" : 8.2 mA	"1101000" : 21.0 mA
"0101001" : 8.4 mA	"1101001" : 21.2 mA
"0101010" : 8.6 mA	"1101010" : 21.4 mA
"0101011" : 8.8 mA	"1101011" : 21.6 mA
"0101100" : 9.0 mA	"1101100" : 21.8 mA
"0101101" : 9.2 mA	"1101101" : 22.0 mA
"0101110" : 9.4 mA	"1101110" : 22.2 mA
"0101111" : 9.6 mA	"1101111" : 22.4 mA
"0110000" : 9.8 mA	"1110000" : 22.6 mA
"0110001" : 10.0 mA	"1110001" : 22.8 mA
"0110010" : 10.2 mA	"1110010" : 23.0 mA
"0110011" : 10.4 mA	"1110011" : 23.2 mA
"0110100" : 10.6 mA	"1110100" : 23.4 mA
"0110101" : 10.8 mA	"1110101" : 23.6 mA
"0110110" : 11.0 mA	"1110110" : 23.8 mA
"0110111" : 11.2 mA	"1110111" : 24.0 mA
"0111000" : 11.4 mA	"1111000" : 24.2 mA
"0111001" : 11.6 mA	"1111001" : 24.4 mA
"0111010" : 11.8 mA	"1111010" : 24.6 mA
"0111011" : 12.0 mA	"1111011" : 24.8 mA
"0111100" : 12.2 mA	"1111100" : 25.0 mA
"0111101" : 12.4 mA	"1111101" : 25.2 mA
"0111110" : 12.6 mA	"1111110" : 25.4 mA
"0111111" : 12.8 mA	"1111111" : 25.6 mA

Address 06h < Main Current slope time setting >

Address	R/W	Bit7	Bit6	Bit5	Bit4	Bit3	Bit2	Bit1	Bit0
06h	W	THL(3)	THL(2)	THL(1)	THL(0)	TLH(3)	TLH(2)	TLH(1)	TLH(0)
Initial Value	C7h	1	1	0	0	0	1	1	1

Bit [7:4] : **THL (3:0)** Main LED current Down transition per 0.2mA step

"0000" :	0.256 ms
"0001" :	0.512 ms
"0010" :	1.024 ms
"0011" :	2.048 ms
"0100" :	4.096 ms
"0101" :	8.192 ms
"0110" :	16.38 ms
"0111" :	32.77 ms
"1000" :	65.54 ms
"1001" :	131.1 ms
"1010" :	196.6 ms
"1011" :	262.1 ms
"1100" :	327.7 ms
"1101" :	393.2 ms
"1110" :	458.8 ms
"1111" :	524.3 ms

(Initial value)

Setting time is counted based on the switching frequency of Charge Pump.

The above value becomes the value of the Typ (1MHz) time.

Refer to "(9) Slope Process" of "The explanation of ALC" for detail.

Bit [3:0] : **TLH (3:0)** Main LED current Up transition per 0.2mA step

"0000" :	0.256 ms
"0001" :	0.512 ms
"0010" :	1.024 ms
"0011" :	2.048 ms
"0100" :	4.096 ms
"0101" :	8.192 ms
"0110" :	16.38 ms
"0111" :	32.77 ms
"1000" :	65.54 ms
"1001" :	131.1 ms
"1010" :	196.6 ms
"1011" :	262.1 ms
"1100" :	327.7 ms
"1101" :	393.2 ms
"1110" :	458.8 ms
"1111" :	524.3 ms

(Initial value)

Setting time is counted based on the switching frequency of Charge Pump.

The above value becomes the value of the Typ (1MHz) time.

Refer to "(9) Slope Process" of "The explanation of ALC" for detail.

Address 07h < ALC mode setting >

Address	R/W	Bit7	Bit6	Bit5	Bit4	Bit3	Bit2	Bit1	Bit0
07h	W	ADCYC(1)	ADCYC(0)	GAIN(1)	GAIN(0)	STYPE	VSB	MDCIR	SBIASON
Initial Value	81h	1	0	0	0	0	0	0	1

Bit [7:6] : **ADCYC(1:0)** ADC Measurement Cycle

- "00" : 0.52 s
- "01" : 1.05 s
- "10" : 1.57 s (Initial value)
- "11" : 2.10 s

Refer to "(4) A/D conversion" of "The explanation of ALC" for detail.

Bit [5:4] : **GAIN(1:0)** Sensor Gain Switching Function Control (This is effective only at STYPE="0".)

- "00" : Auto Change (Initial value)
- "01" : High
- "10" : Low
- "11" : Fixed

Refer to "(3) Gain control" of "The explanation of ALC" for detail.

Bit3 : **STYPE** Ambient Light Sensor Type Select (Linear/Logarithm)

- "0" : For Linear sensor (Initial value)
- "1" : For Log sensor

Refer to "(7) Ambient level detection" of "The explanation of ALC" for detail.

Bit2 : **VSB** SBIAS Output Voltage Control

- "0" : SBIAS output voltage 3.0V (Initial value)
- "1" : SBIAS output voltage 2.6V

Refer to "(2) I/V conversion" of "The explanation of ALC" for detail.

Bit1 : **MDCIR** LED Current Reset Select by Mode Change

- "0" : LED current non-reset when mode change (Initial value)
- "1" : LED current reset when mode change

Refer to "(10) LED current reset when mode change" of "The explanation of ALC" for detail.

Bit0 : **SBIASON**

- "0" : Measurement cycle synchronous
- "1" : Usually ON (at ALCEN=1) (Initial value)

Refer to "(4) A/D conversion" of "The explanation of ALC" for detail.

Address 08h < ADC Data adjustment >

Address	R/W	Bit7	Bit6	Bit5	Bit4	Bit3	Bit2	Bit1	Bit0
08h	W	SOFS(3)	SOFS(2)	SOFS(1)	SOFS(0)	SGAIN(3)	SGAIN(2)	SGAIN(1)	SGAIN(0)
Initial Value	00h	0	0	0	0	0	0	0	0

Bit [7:4] : **SOFS (3:0)** ADC Data Offset adjustment

"1000" :	-8 LSB
"1001" :	-7 LSB
"1010" :	-6 LSB
"1011" :	-5 LSB
"1100" :	-4 LSB
"1101" :	-3 LSB
"1110" :	-2 LSB
"1111" :	-1 LSB
"0000" :	no adjustment
"0001" :	+1 LSB
"0010" :	+2 LSB
"0011" :	+3 LSB
"0100" :	+4 LSB
"0101" :	+5 LSB
"0110" :	+6 LSB
"0111" :	+7 LSB

Offset adjust is performed to ADC data.

Refer to "(5) ADC data Gain/offset adjustment" of "The explanation of ALC" for detail.

Bit [3:0] : **SGAIN (3:0)** ADC Data Inclination adjustment

"1000" :	reserved
"1001" :	reserved
"1010" :	-37.50%
"1011" :	-31.25%
"1100" :	-25.00%
"1101" :	-18.75%
"1110" :	-12.50%
"1111" :	-6.25%
"0000" :	no adjustment
"0001" :	+6.25%
"0010" :	+12.50%
"0011" :	+18.75%
"0100" :	+25.00%
"0101" :	+31.25%
"0110" :	+37.50%
"0111" :	reserved

Gain adjust is performed to ADC data.

The data after adjustment are round off by 8-bit data.

Refer to "(5) ADC data Gain/offset adjustment" of "The explanation of ALC" for detail.

Address 09h < Ambient level (Read Only) >

Address	R/W	Bit7	Bit6	Bit5	Bit4	Bit3	Bit2	Bit1	Bit0
09h	R	-	-	-	-	AMB(3)	AMB(2)	AMB(1)	AMB(0)
Initial Value	(00h)	-	-	-	-	(0)	(0)	(0)	(0)

Bit [7:4] : (Not used)

Bit [3:0] : **AMB (3:0)** Ambient Level

"0000" : 0h
 "0001" : 1h
 "0010" : 2h
 "0011" : 3h
 "0100" : 4h
 "0101" : 5h
 "0110" : 6h
 "0111" : 7h
 "1000" : 8h
 "1001" : 9h
 "1010" : Ah
 "1011" : Bh
 "1100" : Ch
 "1101" : Dh
 "1110" : Eh
 "1111" : Fh

It begins to read Ambient data through I2C, and possible.

To the first AD measurement completion, it is AMB(3:0)=0000.

Refer to "(7) Ambient level detection" of "The explanation of ALC" for detail.

Address 0Ah~19h < Ambient LED Current setting >

Address	R/W	Bit7	Bit6	Bit5	Bit4	Bit3	Bit2	Bit1	Bit0
0Ah~19h	W	IU*(7)	IU*(6)	IU*(5)	IU*(4)	IU*(3)	IU*(2)	IU*(1)	IU*(0)
Initial Value	-	Refer to after page for initial table.							

“**” means 0~F.

Bit7 : (Not used)

Bit [6:0] : IU* (6:0) Main Current at Ambient Level for 0h~Fh

“000000” : 0.2 mA	“100000” : 13.0 mA
“000001” : 0.4 mA	“100001” : 13.2 mA
“000010” : 0.6 mA	“100010” : 13.4 mA
“000011” : 0.8 mA	“100011” : 13.6 mA
“000100” : 1.0 mA	“100100” : 13.8 mA
“000101” : 1.2 mA	“100101” : 14.0 mA
“000110” : 1.4 mA	“100110” : 14.2 mA
“000111” : 1.6 mA	“100111” : 14.4 mA
“001000” : 1.8 mA	“100100” : 14.6 mA
“001001” : 2.0 mA	“100101” : 14.8 mA
“001010” : 2.2 mA	“100110” : 15.0 mA
“001011” : 2.4 mA	“100111” : 15.2 mA
“001100” : 2.6 mA	“100100” : 15.4 mA
“001101” : 2.8 mA	“100110” : 15.6 mA
“001110” : 3.0 mA	“100111” : 15.8 mA
“001111” : 3.2 mA	“100100” : 16.0 mA
“001000” : 3.4 mA	“101000” : 16.2 mA
“001001” : 3.6 mA	“101001” : 16.4 mA
“001010” : 3.8 mA	“101010” : 16.6 mA
“001011” : 4.0 mA	“101011” : 16.8 mA
“001100” : 4.2 mA	“101000” : 17.0 mA
“001101” : 4.4 mA	“101010” : 17.2 mA
“001110” : 4.6 mA	“101011” : 17.4 mA
“001111” : 4.8 mA	“101000” : 17.6 mA
“001000” : 5.0 mA	“101100” : 17.8 mA
“001001” : 5.2 mA	“101101” : 18.0 mA
“001010” : 5.4 mA	“101110” : 18.2 mA
“001011” : 5.6 mA	“101111” : 18.4 mA
“001100” : 5.8 mA	“101100” : 18.6 mA
“001101” : 6.0 mA	“101110” : 18.8 mA
“001110” : 6.2 mA	“101111” : 19.0 mA
“001111” : 6.4 mA	“110000” : 19.2 mA
“010000” : 6.6 mA	“110001” : 19.4 mA
“010001” : 6.8 mA	“110010” : 19.6 mA
“010010” : 7.0 mA	“110011” : 19.8 mA
“010011” : 7.2 mA	“110000” : 20.0 mA
“010100” : 7.4 mA	“110010” : 20.2 mA
“010101” : 7.6 mA	“110011” : 20.4 mA
“010110” : 7.8 mA	“110000” : 20.6 mA
“010111” : 8.0 mA	“110010” : 20.8 mA
“010100” : 8.2 mA	“110011” : 21.0 mA
“010101” : 8.4 mA	“110100” : 21.2 mA
“010110” : 8.6 mA	“110101” : 21.4 mA
“010111” : 8.8 mA	“110110” : 21.6 mA
“011000” : 9.0 mA	“110111” : 21.8 mA
“011001” : 9.2 mA	“110100” : 22.0 mA
“011010” : 9.4 mA	“110110” : 22.2 mA
“011011” : 9.6 mA	“110111” : 22.4 mA
“011000” : 9.8 mA	“111000” : 22.6 mA
“011001” : 10.0 mA	“111001” : 22.8 mA
“011010” : 10.2 mA	“111010” : 23.0 mA
“011011” : 10.4 mA	“111011” : 23.2 mA
“011100” : 10.6 mA	“111000” : 23.4 mA
“011101” : 10.8 mA	“111010” : 23.6 mA
“011110” : 11.0 mA	“111011” : 23.8 mA
“011111” : 11.2 mA	“111000” : 24.0 mA
“011100” : 11.4 mA	“111100” : 24.2 mA
“011101” : 11.6 mA	“111101” : 24.4 mA
“011110” : 11.8 mA	“111110” : 24.6 mA
“011111” : 12.0 mA	“111111” : 24.8 mA
“011100” : 12.2 mA	“111100” : 25.0 mA
“011101” : 12.4 mA	“111110” : 25.2 mA
“011110” : 12.6 mA	“111111” : 25.4 mA
“011111” : 12.8 mA	“111100” : 25.6 mA

Address 1Ah < Key Driver 2 value decision control setting >

Address	R/W	Bit7	Bit6	Bit5	Bit4	Bit3	Bit2	Bit1	Bit0
1Ah	W	-	-	CHYS(1)	CHYS(0)	CTH(3)	CTH(2)	CTH(1)	CTH(0)
Initial Value	2Ah	-	-	1	0	1	0	1	0

Bit [7:6] : (Not used)

Bit [5:4] : **CHYS(1:0)** Key DriverON Brightness hysteresis

- "00" : Ambient 1h Width
- "01" : Ambient 2h Width
- "10" : Ambient 3h Width (initial)
- "11" : Ambient 4h Width

Refer to "(12) Key back light value decision" of "The explanation of ALC" for detail.

Bit [3:0] : **CTH (3:0)** Key DriverOFF Brightness threshold

- "0000" : Ambient level 0h OFF
- "0001" : Ambient level 1h OFF
- "0010" : Ambient level 2h OFF
- "0011" : Ambient level 3h OFF
- "0100" : Ambient level 4h OFF
- "0101" : Ambient level 5h OFF
- "0110" : Ambient level 6h OFF
- "0111" : Ambient level 7h OFF
- "1000" : Ambient level 8h OFF
- "1001" : Ambient level 9h OFF
- "1010" : Ambient level Ah OFF (initial)
- "1011" : Ambient level Bh OFF
- "1100" : Ambient level Ch OFF
- "1101" : Ambient level Dh OFF
- "1110" : Ambient level Eh OFF
- "1111" : Ambient level Fh OFF

Refer to "(12) Key back light value decision" of "The explanation of ALC" for detail.

Address 1Bh < OUT KEY Output Mode setting >

Address	R/W	Bit7	Bit6	Bit5	Bit4	Bit3	Bit2	Bit1	Bit0
1Bh	W	-	-	-	KBMD	OUT4MD	OUT3MD	OUT2MD	OUT1MD
Initial Value	00h	-	-	-	0	0	0	0	0

Bit [7:5] : (Not used)

Bit4 : **KBMD** Key back light mode choice (ALC/ Individual)

“0” : KBLT ALC Control

“1” : KBLT Individual Control

Refer to “(13) Key back light PWM control” of “The explanation of “ALC” for detail.

Bit3 : **OUT4MD** OUTCNT External Control setting

“0” : OUTCNT invalid, OUT4 output depends on output control by OUT4EN.

“1” : OUT4 output depends on output control by OUT4EN with OUTCNT=H.
With OUTCNT=L, OUT4=Hi-z (compulsory off).

Refer to “The explanation of OUTPWM control” for detail.

Bit2 : **OUT3MD** OUTCNT External Control setting

“0” : OUTCNT invalid, OUT3 output depends on output control by OUT3EN.

“1” : OUT3 output depends on output control by OUT3EN with OUTCNT=H.
With OUTCNT=L, OUT3=Hi-z (compulsory off).

Refer to “The explanation of OUTPWM control” for detail.

Bit1 : **OUT2MD** OUTCNT External Control setting

“0” : OUTCNT invalid, OUT2 output depends on output control by OUT2EN.

“1” : OUT2 output depends on output control by OUT2EN with OUTCNT=H.
With OUTCNT=L, OUT2=Hi-z (compulsory off).

Refer to “The explanation of OUTPWM control” for detail.

Bit0 : **OUT1MD** OUTCNT External Control setting

“0” : OUTCNT invalid, OUT1 output depends on output control by OUT1EN.

“1” : OUT1 output depends on output control by OUT1EN with OUTCNT=H.
With OUTCNT=L, OUT1=Hi-z (compulsory off).

Refer to “The explanation of OUTPWM control” for detail.

Address 1Ch < OUT KEY Output level setting >

Address	R/W	Bit7	Bit6	Bit5	Bit4	Bit3	Bit2	Bit1	Bit0
1Ch	W/R	-	-	-	KBEN	OUT4EN	OUT3EN	OUT2EN	OUT1EN
Initial Value	00h	-	-	-	0	0	0	0	0

Bit [7:5] : (Not used)

Bit4 : **KBEN** KBLT output level setting (non-ALC mode)

“0” : KBLT L 出力

“1” : KBLT H 出力

Refer to “(13) Key back light PWM control” of “The explanation of ALC” for detail.

Bit3 : **OUT4EN** OUT4 Output level setting

“0” : OUT4 Hi-Z Output

“1” : OUT4 L Output

Refer to “The explanation of OUTPWM control” for detail.

Bit2 : **OUT3EN** OUT3 Output level setting

“0” : OUT3 Hi-Z Output

“1” : OUT3 L Output

Refer to “The explanation of OUTPWM control” for detail.

Bit1 : **OUT2EN** OUT2 Output level setting

“0” : OUT2 Hi-Z Output

“1” : OUT2 L Output

Refer to “The explanation of OUTPWM control” for detail..

Bit0 : **OUT1EN** OUT1Output level setting

“0” : OUT1 Hi-Z Output

“1” : OUT1 L Output

Refer to “The explanation of OUTPWM control” for detail.

Address 1Dh < OUT KEY Output Mode setting >

Address	R/W	Bit7	Bit6	Bit5	Bit4	Bit3	Bit2	Bit1	Bit0
1Dh	W	FPWM	-	-	-	KBSLP (1)	KBSLP (0)	OUTSLP(1)	OUTSLP(0)
Initial Value	00h	0	-	-	-	0	0	0	0

Bit7 : **FPWM** Key Driver, OUT1~4 PWM cycle setting

“0” : 2.048 ms

“1” : 4.096 ms

Refer to “(13) Key back light PWM control” of “The explanation of ALC” and “The explanation of OUTPWM control” for detail.

Bit [6:4] : (未使用)

Bit [3:2] : **KBSLP(1:0)** The slope time of around 1step for Key Driver PWM

FPWM=0 FPWM=1

“00” : 0.00 ms 0.00 ms

“01” : 16.38 ms 32.77 ms

“10” : 32.77 ms 65.54 ms

“11” : 65.54 ms 131.08 ms

Refer to “(13) Key back light PWM control” of “The explanation of ALC” for detail.

Bit [1:0] : **OUTSLP(1:0)** The slope time of around 1step for OUT1~4 PWM

FPWM=0 FPWM=1

“00” : 0.00 ms 0.00 ms

“01” : 16.38 ms 32.77 ms

“10” : 32.77 ms 65.54 ms

“11” : 65.54 ms 131.08 ms

Refer to “The explanation of OUTPWM control” for detail.

●Reset

There are two kinds of reset, software reset and hardware reset

- (1) Software reset
 - All the registers are initialized by SFTRST="1".
 - SFTRST is an automatically returned to "0". (Auto Return 0).
- (2) Hardware reset
 - It shifts to hardware reset by changing RESETB pin "H" → "L".
 - The condition of all the registers under hardware reset pin is returned to the initial value, and it stops accepting all address.
 - It's possible to release from a state of hardware reset by changing RESETB pin "L" → "H".
 - RESETB pin has delay circuit. It doesn't recognize as hardware reset in "L" period under 5 μ s.
- (3) Reset Sequence
 - When hardware reset was done during software reset, software reset is canceled when hardware reset is canceled. (Because the initial value of software reset is "0")

●VIODET

The decline of the VIO voltage is detected, and faulty operation inside the LSI is prevented by giving resetting to Levelsift block
Image Block Diagram

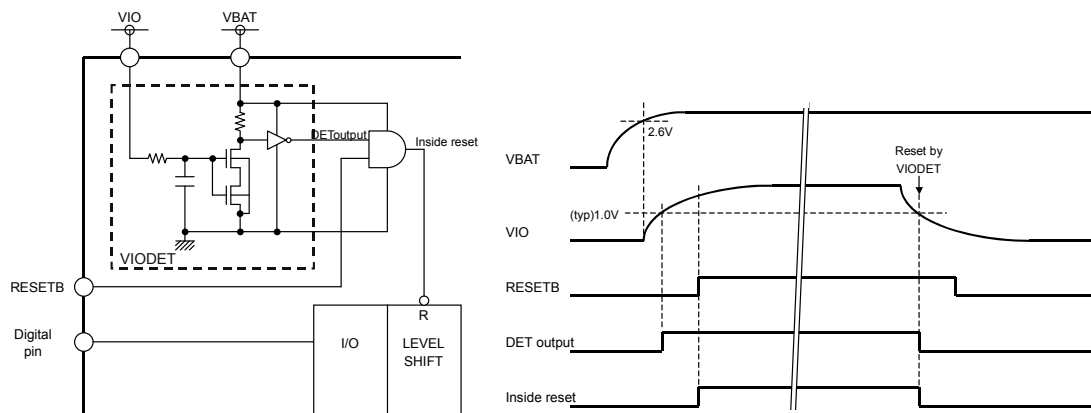

When the VIO voltage becomes more than typ1.0V(V_{th} of NMOS in the IC), VIODET is removed.
On the contrary, when VIO is as follows 1.0V, it takes reset.(The VBAT voltage being a prescribed movement range)

●thermal shutdown

A thermal shutdown function is effective in the following block.

- DC/DC (Charge Pump)
- LED Driver
- SBIAS

The thermal shutdown function is detection temperature that it works is about 195°C.
Detection temperature has a hysteresis, and detection release temperature is about 175 °C.
(Design reference value)

●DC/DC Explanation for operate

Start

DC/DC circuit operates when any LED turns ON. (DCDCFON=0)

When the start of the DC/DC circuit is done, it has the soft start function to prevent a rush current.

Force of VBAT and VIO is to go as follows.

DCDCMD=1 must be set in the fixed voltage mode and DCDCMD=DCDCFON=1 must be set when DCDC output takes place regardless of LEDs.

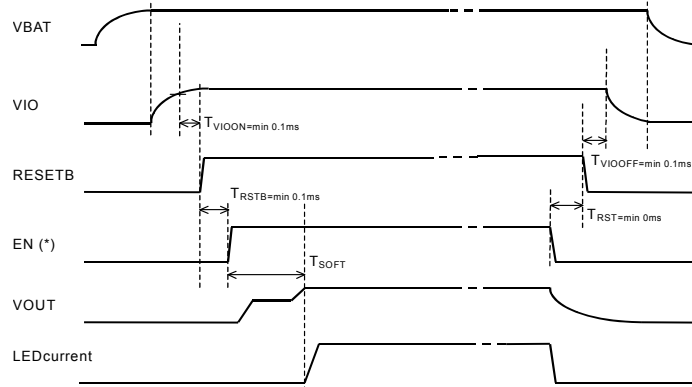

(*) An EN signal means the following in the upper figure.

EN = "MLEDEN" or "W * EN"

(= LED The LED lighting control of a setup of connection VOUT)

But, as for $T_a > T_{TSD}$ (typ : 195° C), a protection function functions, and an EN signal doesn't become effective.

T_{SOFT} changes by the capacitor connected to VOUT and inside OSC.

T_{SOFT} is Typ 200 μ s (when the output capacitor of VOUT =1.0 μ F).

Over Voltage protection / Over Current protection

DC/DC circuit output (VOUT) is equipped with the over-voltage protection and the over current protection function.

A VOUT over-voltage detection voltage is about 6.0V(typ). (VOUT at the time of rise in a voltage)

A detection voltage has a hysteresis, and a detection release voltage is about 5.1V(typ).

And, when VOUT output short to ground, input current of the battery terminal is limited by an over current protection function.

Mode transition

The transition of boosts multiple transits automatically by VBAT Voltage and the VOUT Pin Voltage.

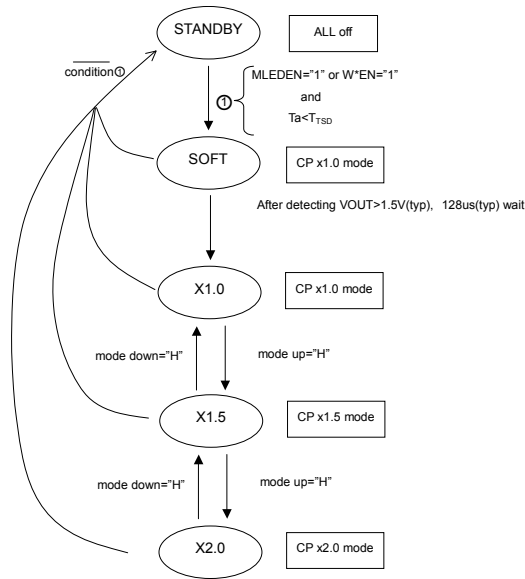

The mode transition of the charge pump works as follows.

<x1.0→x1.5→x2.0 Mode transition>

The transition of the mode is done when VOUT was compared with VBAT and the next condition was satisfied.

x1.0→x1.5 Mode transition $V_{BAT} \leq V_{OUT} + (R_{on10} \times I_{out})$ (LED Pin feedback : $V_{OUT} = V_f + 0.2(Typ)$) x1.5→x2.0 Mode transition $V_{BAT} \times 1.5 \leq V_{OUT} + (R_{on15} \times I_{out})$ (LED Pin feedback : $V_{OUT} = V_f + 0.2(Typ)$)

Ron10: x1 Charge pump on resistance 1.2Ω(Typ)

Ron15: x1.5 Charge pump on resistance 7.1Ω(Typ)

<x2.0→x1.5→x1.0 Mode transition>

The transition of the mode is done when the ratio of VOUT and VBAT is detected and it exceeds a fixed voltage ratio.

x1.5→x1.0 Mode transition $V_{BAT} / V_{OUT} = 1.16(\text{Design value})$ x2.0→x1.5 Mode transition $V_{BAT} / V_{OUT} = 1.12(\text{Design value})$
--

●LED Driver

The LED driver of 6ch is constructed as the ground plan.

Equivalence control is possible with LED1 - 4(LED4 can choose use/un-use with a register W4MD.).

LED5, LED6 is controllable individually.

As for LED5, LED6, grouping setting to the main control is possible, and main control becomes effective for the main group in the allotment. LED5 and LED6 are setups of grouping to the main control.

When LED5 and LED6 are used by the individual control, a slope time setup (register THL and TLH) doesn't become effective.

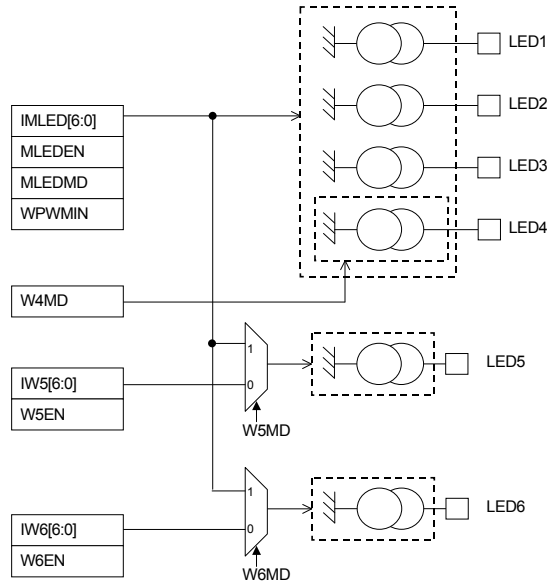

●General-purpose Output Ports

General-purpose Output Ports 4ch is constructed as the ground plan.

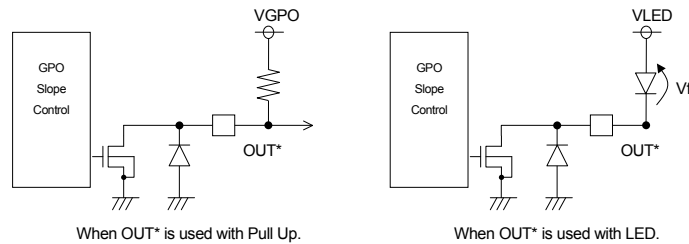

●The explanation of ALC (Auto Luminous Control)

LCD backlight current adjustment is possible in the basis of the data detected by external ambient light sensor.

- Extensive selection of the ambient light sensors (Photo Diode, Photo Transistor, Photo IC(linear/logarithm)) is possible by building adjustment feature of Sensor bias, gain adjustment and offset adjustment.
- Ambient data is changed into ambient level by digital data processing, and it can be read through I²C I/F.
- Register setting can customize a conversion to LED current. (Initial value is pre-set.)
- Natural dimming of LED driver is possible with the adjustment of the current transition speed.
- ON/ off of the key back light can be controlled automatically by the brightness.

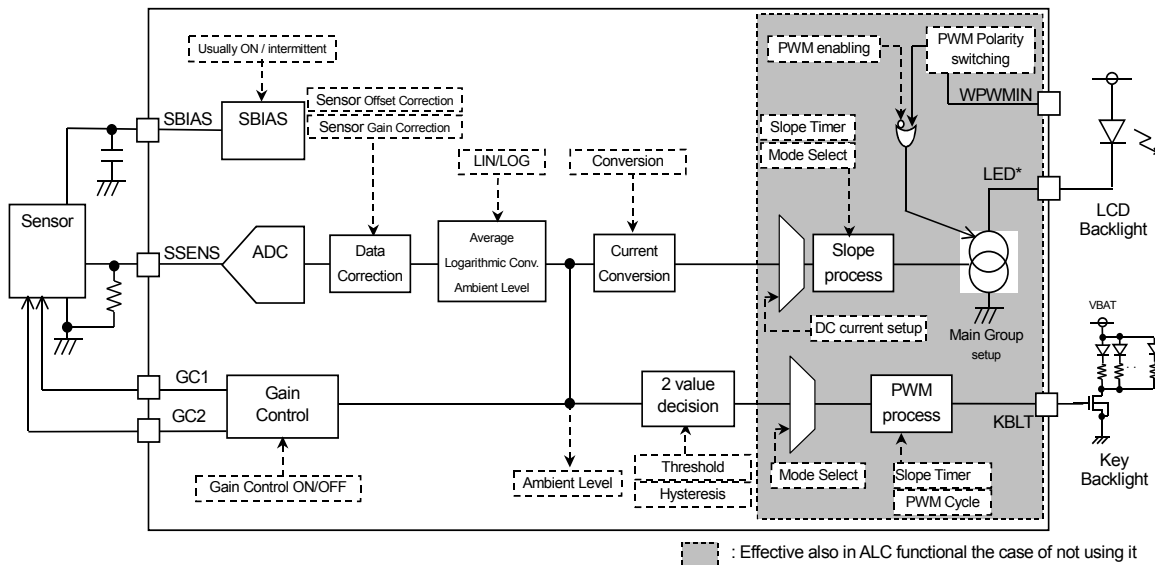

(1) Auto Luminous Control ON/OFF

- ALC block can be independent setting ON/OFF.
- It can use only to measure the Ambient level.
Register : ALCEN
Register : MLEDEN
Register : MLEDMD
- Refer to under about the associate ALC mode and Main LED current.

ALCEN	MLEDEN	MLEDMD	Sensor I/F	LED control	Mode	Main LED current	
0	0	x	OFF (AMB(3:0)=0h)	OFF	OFF	-	
0	1	0		ON	Non ALC mode	IMLED(6:0)	
0	1	1		ON		IU0(6:0) (*1)	
1	0	x	ON	OFF	ALC mode	-	
1	1	0		ON		ON	IMLED(6:0)
1	1	1				ON	ALC mode (*2)

(*1) At this mode, because Sensor I/F is OFF, AMB(3:0)=0h.
So, Main LED current is selected IU0(6:0).

(*2) At this mode, Main LED current is selected IU0(6:0)~IUF(6:0)
It becomes current value corresponding to each brightness.

(2) I/V conversion

- The bias voltage and external resistance for the I-V conversion (Rs) are adjusted with adaptation of sensor characteristic
- The bias voltage is selectable by register setup.

Register : VSB

“0” : SBIAS output voltage 3.0V

“1” : SBIAS output voltage 2.6V

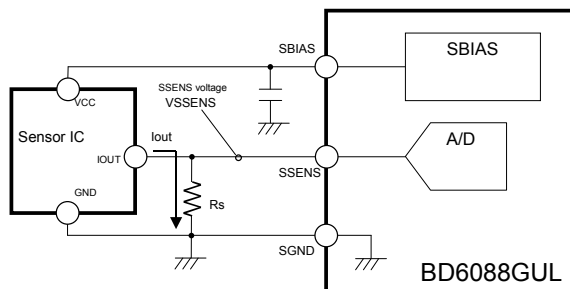

Rs : Sense resistance (A sensor output current is changed into the voltage value.)
 SBIAS : Bias power supply terminal for the sensor (3.0V / 2.6V by register setting)
 SSENS : Sense voltage input terminal

$$\text{SSENS Voltage} = I_{out} \times R_s$$

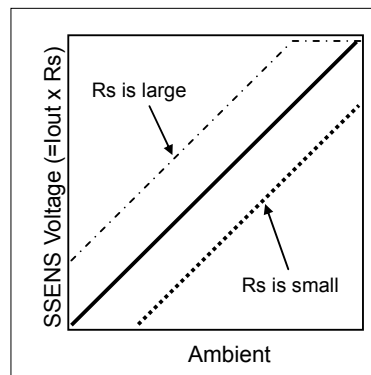
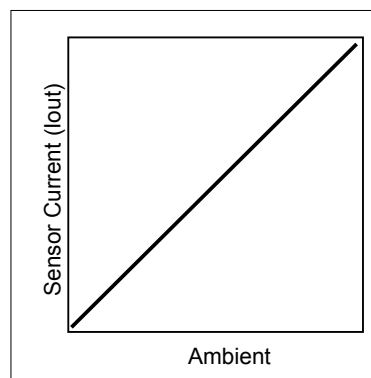

(3) Gain control

- Sensor gain switching function is built in to extend the dynamic range.
- It is controlled by register setup.
- When automatic gain control is off, the gain status can be set up the manual.
Register : GAIN(1:0)
- GC1 and GC2 are outputted corresponding to each gain status.

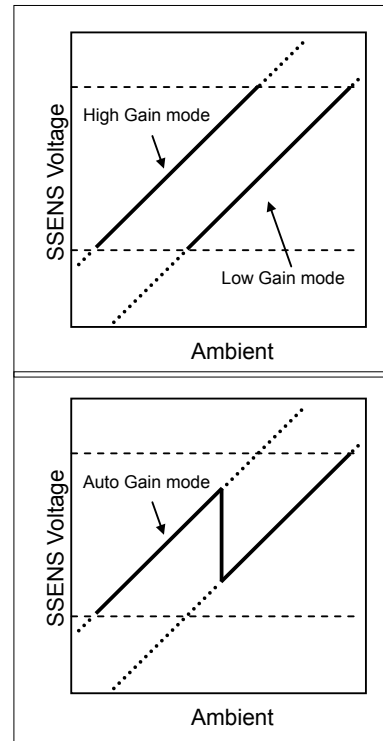

	Example 1 (Use BH1600FVC)			Example 2			Example 3	
Applicationexample				<p>Resister values are relative</p>				
Operating mode	Auto	Manual		Auto	Manual		Fixed	
		High	Low		High	Low		
GAIN(1:0) setting	00	01	10	00	01	10	11	
Gain status	High Low	High	Low	High Low	High	Low	-	
GC1 output		L		L		L		
GC2 output	L		L		L		L	

: This means that it becomes High with A/D measurement cycle synchronously.

(*1) : Set up the relative ratio of the resistance in the difference in the brightness change of the High Gain mode and the Low Gain mode carefully.

(4) A/D conversion

- The detection of ambient data is done periodically for the low power.
- SBIAS and ADC are turned off except for the ambient measurement.
- The sensor current may be shut in this function, it can possible to decrease the current consumption.
- SBIAS pin and SSENS pin are pull-down in internal when there are OFF.
- SBIAS circuit has the two modes. (Usually ON mode or intermittent mode)

Register : ADCYC(1:0)

Register : SBIASON

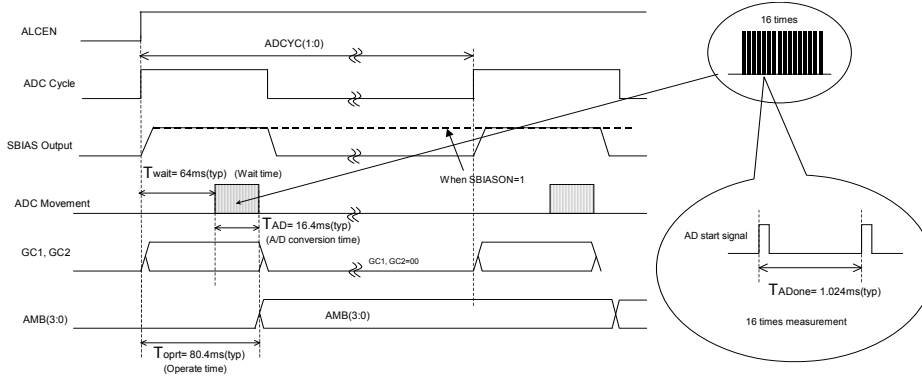

(5) ADC data Gain / offset adjustment

- To correct the characteristic dispersion of the sensor, Gain and offset adjustment to ADC output data is possible.
- They are controlled by register setup.

Register : SGAIN(3:0)

Register : SOFS(3:0)

< Gain Adjustment >

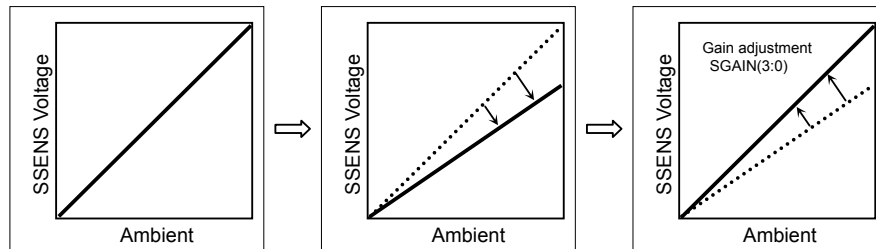

< Offset Adjustment >

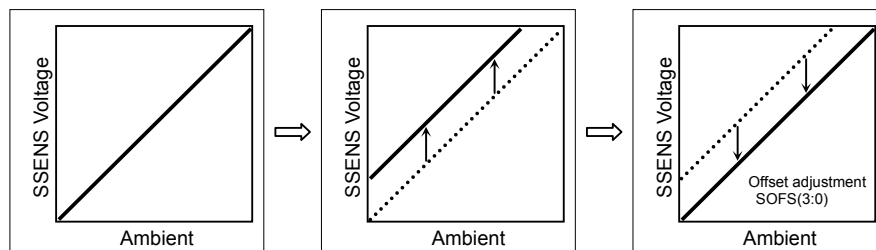

(6) Average filter

- Average filter is built in to rid noise or flicker.
- Average is 16 times

(7) Ambient level detection

- Averaged A/D value is converted to Ambient level corresponding to Gain control and sensor type.
- Ambient level is judged to rank of 16 steps by ambient data.
- The type of ambient light sensor can be chosen by register.
(Linear type sensor / Logarithm type sensor)

Register : STYPE

“0” : For Linear sensor

“1” : For Log sensor

- Ambient level is output through I²C.

Register : AMB(3:0)

STYPE	0					1
GAIN(1:0)	00		10	01	11	xx
GAIN	Low	High	Low	High	-	-
Ambient Level	SSENS Voltage					
0h	/	VoS×0/256	/	VoS×0/256	VoS×0/256	VoS×0/256 VoS×17/256
1h		VoS×1/256		VoS×1/256	VoS×1/256	VoS×18/256 VoS×26/256
2h		VoS×2/256		VoS×2/256	VoS×2/256	VoS×27/256 VoS×36/256
3h		VoS×3/256 VoS×4/256		VoS×3/256 VoS×4/256	VoS×3/256 VoS×4/256	VoS×37/256 VoS×47/256
4h		VoS×5/256 VoS×7/256		VoS×5/256 VoS×7/256	VoS×5/256 VoS×7/256	VoS×48/256 VoS×59/256
5h	VoS×0/256	VoS×8/256 VoS×12/256	VoS×0/256	VoS×8/256 VoS×12/256	VoS×7/256 VoS×9/256	VoS×60/256 VoS×71/256
6h	VoS×1/256	VoS×13/256 VoS×21/256	VoS×1/256	VoS×13/256 VoS×21/256	VoS×10/256 VoS×13/256	VoS×72/256 VoS×83/256
7h	VoS×2/256 VoS×3/256	VoS×22/256 VoS×37/256	VoS×2/256 VoS×3/256	VoS×22/256 VoS×37/256	VoS×14/256 VoS×19/256	VoS×84/256 VoS×95/256
8h	VoS×4/256 VoS×6/256	VoS×38/256 VoS×65/256	VoS×4/256 VoS×6/256	VoS×38/256 VoS×65/256	VoS×20/256 VoS×27/256	VoS×96/256 VoS×107/256
9h	VoS×7/256 VoS×11/256	VoS×66/256 VoS×113/256	VoS×7/256 VoS×11/256	VoS×66/256 VoS×113/256	VoS×28/256 VoS×38/256	VoS×108/256 VoS×119/256
Ah	VoS×12/256 VoS×20/256	VoS×114/256 VoS×199/256	VoS×12/256 VoS×20/256	VoS×114/256 VoS×199/256	VoS×39/256 VoS×53/256	VoS×120/256 VoS×131/256
Bh	VoS×21/256 VoS×36/256	VoS×200/256 VoS×255/256	VoS×21/256 VoS×36/256	VoS×200/256 VoS×255/256	VoS×54/256 VoS×74/256	VoS×132/256 VoS×143/256
Ch	VoS×37/256 VoS×64/256	/	VoS×37/256 VoS×64/256	/	VoS×75/256 VoS×104/256	VoS×144/256 VoS×155/256
Dh	VoS×65/256 VoS×114/256		VoS×65/256 VoS×114/256		VoS×105/256 VoS×144/256	VoS×156/256 VoS×168/256
Eh	VoS×115/256 VoS×199/256		VoS×115/256 VoS×199/256		VoS×145/256 VoS×199/256	VoS×169/256 VoS×181/256
Fh	VoS×200/256 VoS×255/256		VoS×200/256 VoS×255/256		VoS×200/256 VoS×255/256	VoS×182/256 VoS×255/256

- This is in case of not adjustments of the gain/offset control.
- In the Auto Gain control mode, sensor gain changes in gray-colored ambient level.
- “/” : This means that this zone is not outputted in this mode.

(8) LED current assignment

- LED current can be assigned as each of 16 steps of the ambient level.
 - Setting of a user can do by overwriting, though it prepares for the table setup in advance.
- Register : IU*(6:0)

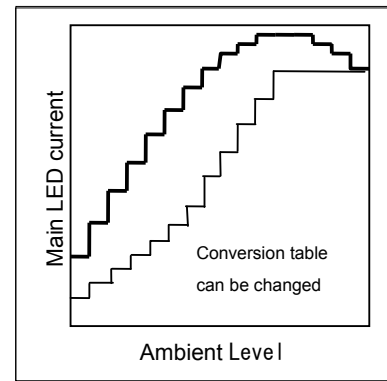

Conversion Table (initial value)

Ambient Level	Setting data	Current value	Ambient Level	Setting data	Current value
0h	11h	3.6mA	8h	48h	14.6mA
1h	13h	4.0mA	9h	56h	17.4mA
2h	15h	4.4mA	Ah	5Fh	19.2mA
3h	18h	5.0mA	Bh	63h	20.0mA
4h	1Eh	6.2mA	Ch	63h	20.0mA
5h	25h	7.6mA	Dh	63h	20.0mA
6h	2Fh	9.6mA	Eh	63h	20.0mA
7h	3Bh	12.0mA	Fh	63h	20.0mA

(9) Slope process

- Slope process is given to LED current to dim naturally.
 - LED current changes in the 256Step gradation in sloping.
 - Up(dark→bright),Down(bright→dark) LED current transition speed are set individually.
- Register : THL(3:0)
Register : TLH(3:0)
- Main LED current changes as follows at the time as the slope. TLH (THL) is setup of time of the current step 2/256.

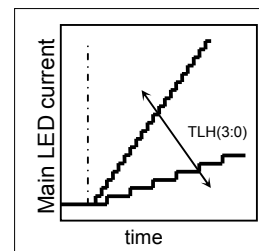
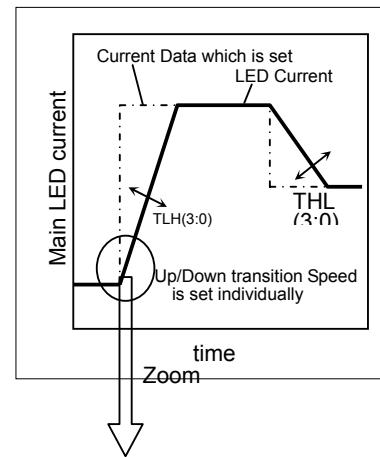
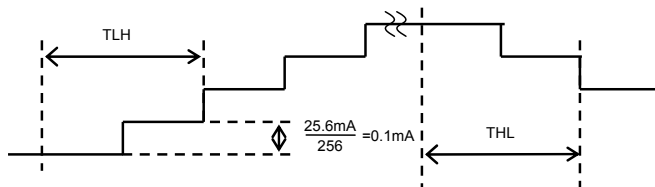

- (10) LED current reset when mode change
- When mode is changed (ALC↔Non ALC), it can select the way to sloping.
- Register : MDCIR
- "0" : LED current non-reset when mode change
 - "1" : LED current reset when mode change

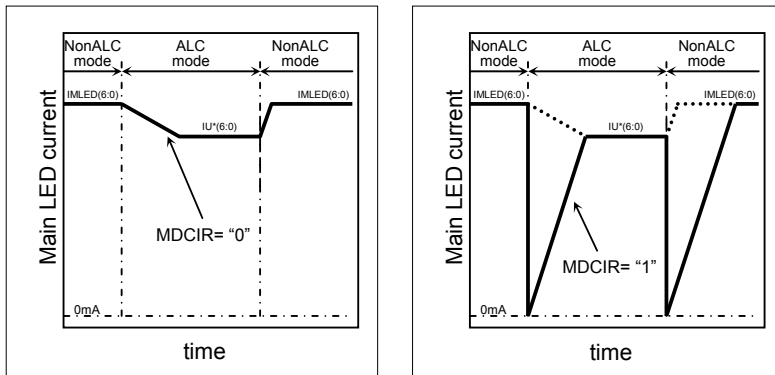

- (11) Current adjustment
- When the register setting permits it, PWM drive by the external terminal (WPWMIN) is possible.
- Bit Name : WPWMEN
- It is suitable for the intensity correction by external control, because PWM based on Main LED current of register setup or ALC control.

WPWMEN (Register)	WPWMIN(External Pin)		Main group LED current
	WPWMPOL=H (Register)	WPWMPOL=L (Register)	
0	L	H	Normal operation
	H	L	Normal operation
1	L	H	Forced OFF
	H	L	Normal operation

" Normal operation " depends on the setup of each register.

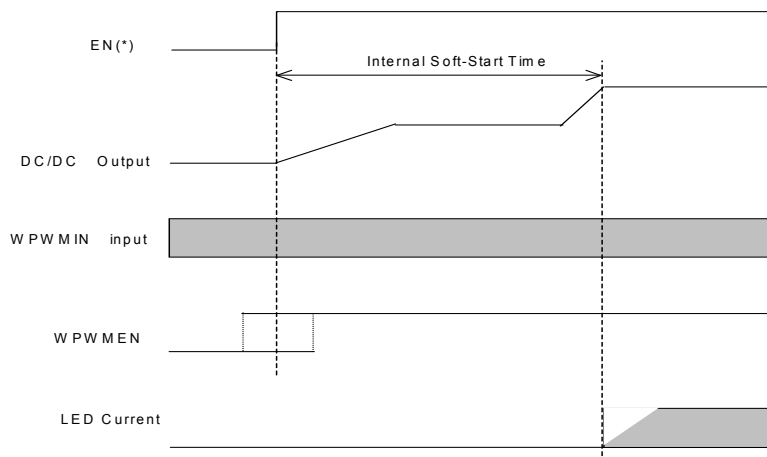

EN(*) : it means "MLEDEN" or "W*EN".

It is possible to make it a WPWMIN input and WPWMEN=1 in front of EN(*). A PWM drive becomes effective after the time of an LED current standup.

When rising during PWM operation, as for the standup time of a DC/DC output, only the rate of PWM Duty becomes late. Appearance may be influenced when extremely late frequency and extremely low Duty are inputted.

Please secure 80 μs or more of H sections at the time of PWM pulse Force.

(12) Key back light 2-value decision

- Capable of comparing luminosity factor data with judgment threshold value with a hysteresis to determine binary judgment for illumination intensity.
- Available for key backlight ON/OFF control based on illumination intensity.
- Sets a threshold value and a hysteresis via the registers.

Bit Name : CTH(3:0)

Bit Name : CHYS(1:0)

The threshold value and hysteresis must meet the following condition:

$$CTH \text{ setting} \geq CHYS \text{ setting}$$

Example: The backlight turns on with an illumination intensity of 7 and turns off with CTH[3:0]=7h CHYS[1:0]=1h

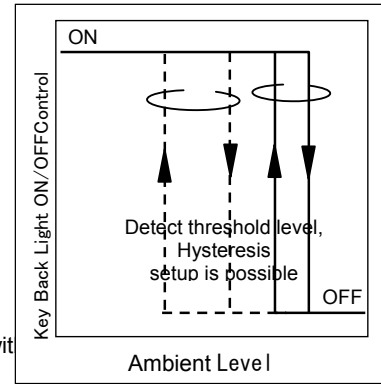

(13) Key back light PWM control

- Outputs ON or OFF for binary judgment via the KBLT terminal after PWM processing.
- Allows a slope time to be set in the register via PWM.
- 32 levels of duties prepared as MAX Duty are sequentially stepped at KBSLP time intervals.

Bit name: KBSLP(1:0)

- A PWM cycle can choose 2 value.

Bit name: FPWM

- It can be changed to the single control by the following setup of a register. The KBSLP(1:0), FPWM setting is effective.

KBMD	KBEN	KBLT output
0	-	Depend on ALC setting
1	0	0
	1	1

- 32 levels Duty ratio (H level section) becomes the following set point.

Step	Duty(%)	Step	Duty(%)
0	0.00	16	25.00
1	1.56	17	28.13
2	3.13	18	31.25
3	4.69	19	34.38
4	6.25	20	37.50
5	7.81	21	40.63
6	9.38	22	45.31
7	10.94	23	50.00
8	12.50	24	56.25
9	14.06	25	62.50
10	15.63	26	68.75
11	17.19	27	75.00
12	18.75	28	81.25
13	20.31	29	87.50
14	21.88	30	93.75
15	23.44	31	100.00

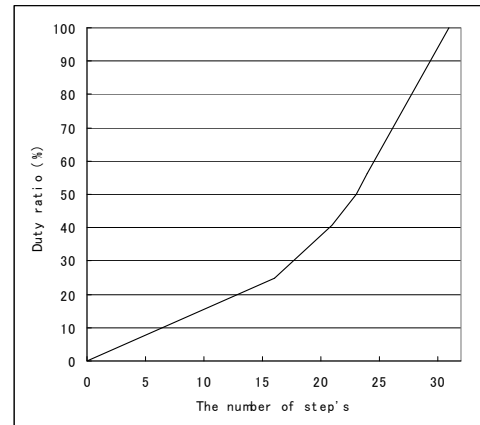

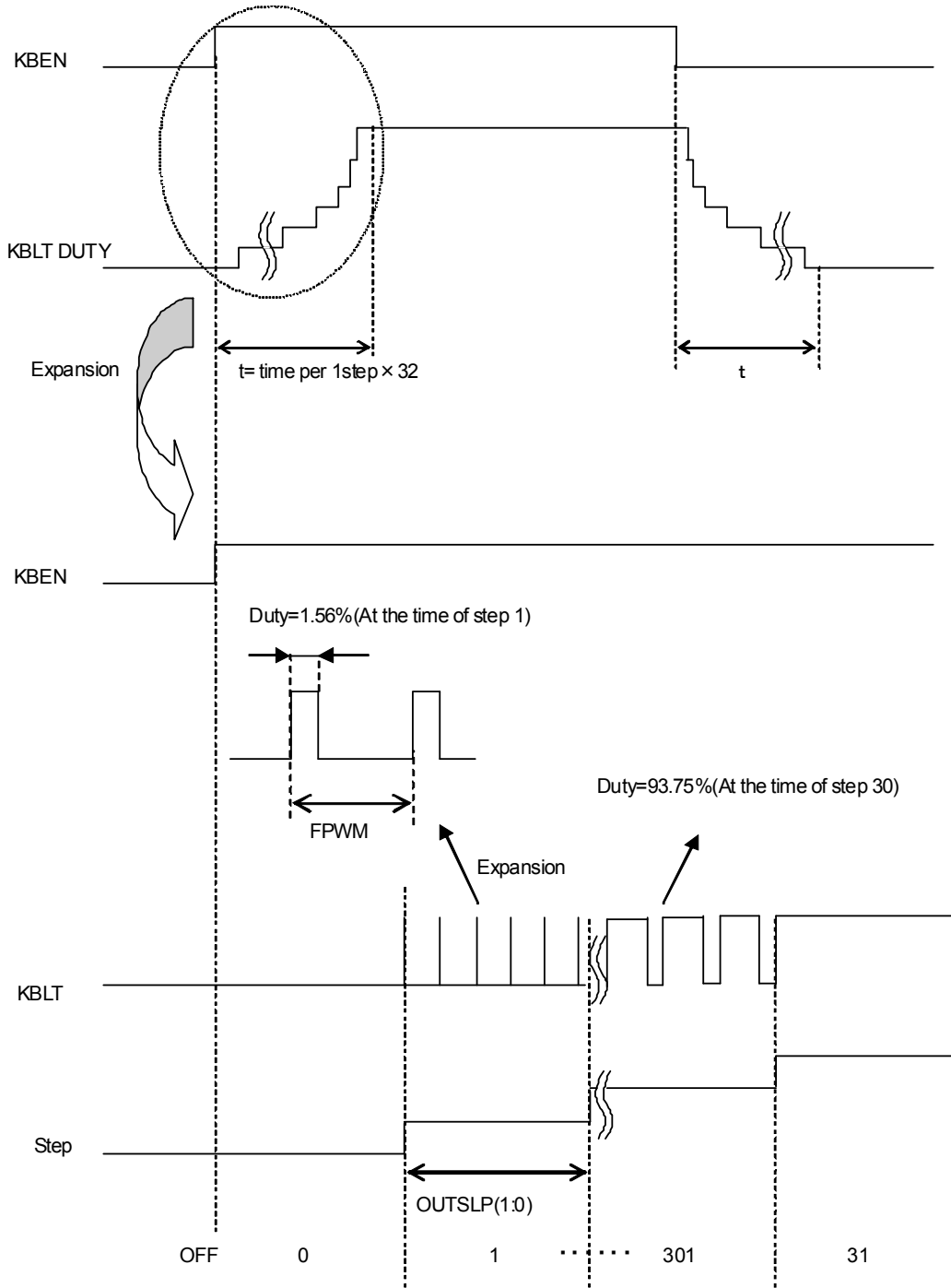

●OUT PWM Control

- PWM A fixed signal is output from OUT1 ~ 4 terminal.
- Allows a slope time to be set in the register via PWM.
32 levels of duties prepared as MAX Duty are sequentially stepped at OUTSLP time intervals.
Bit name: OUTSLP(1:0)
- A PWM cycle can choose 2 value.
Bit name: FPWM
- Forced OFF is made with an OUTCNT terminal.
Bit name: OUT*MD

OUT*MD	OUT*EN	OUTCNT	OUT*出力
0	0	-	After the PWM slope, Hi-z (Duty 0%)
	1	-	After the PWM slope, L (Duty 100%)
1	0	0	Hi-z (LED is compulsory lights off)
		1	Hi-z(Duty0%) *1
	1	0	Hi-z (LED is compulsory lights off)
		1	L (Duty100%) *

*1 But, Duty in the middle of the PWM slope is output at the time as the PWM slope by OUT*EN.

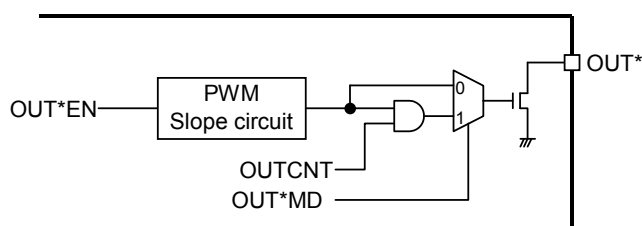

① Setup of a slope (Except for OUTSLP [1:0] =00h)

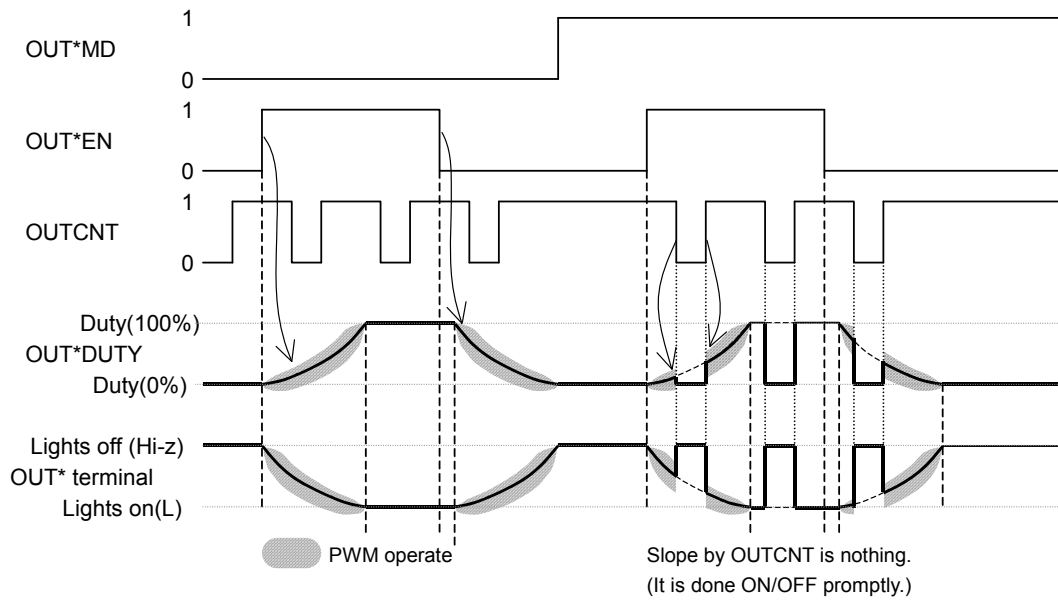

OUT*DUTY show the H section of the output step NMOS gate. (Duty 0%~100 %)

② Slope setup nothing (OUTSLP[1:0]=00h)

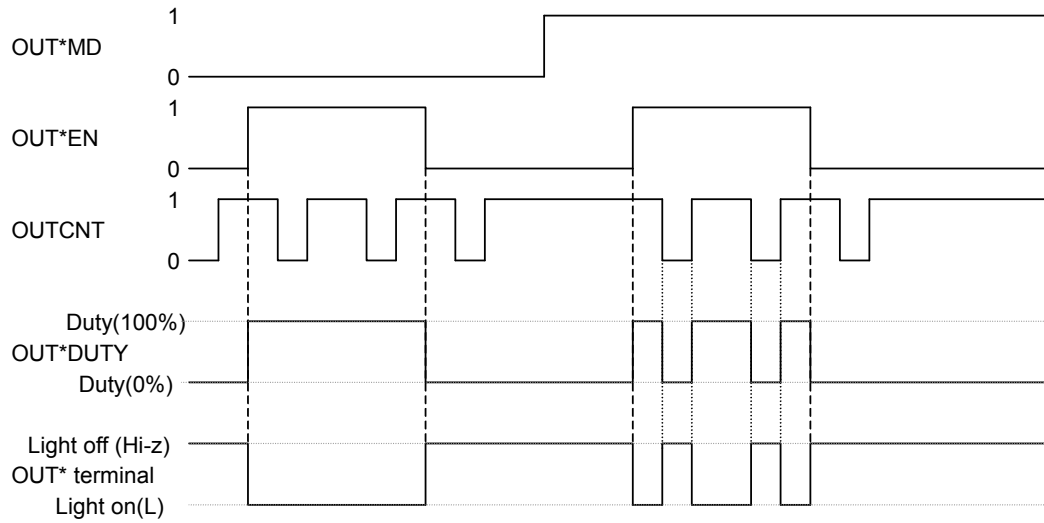

OUT*DUTY shows the H section of the output step NMOS gate. (Duty 0%~100%)

• 32 levels Duty ratio (H level section) becomes the following set point.

Step	Duty(%)	Step	Duty(%)
0	0.00	16	25.00
1	1.56	17	28.13
2	3.13	18	31.25
3	4.69	19	34.38
4	6.25	20	37.50
5	7.81	21	40.63
6	9.38	22	45.31
7	10.94	23	50.00
8	12.50	24	56.25
9	14.06	25	62.50
10	15.63	26	68.75
11	17.19	27	75.00
12	18.75	28	81.25
13	20.31	29	87.50
14	21.88	30	93.75
15	23.44	31	100.00

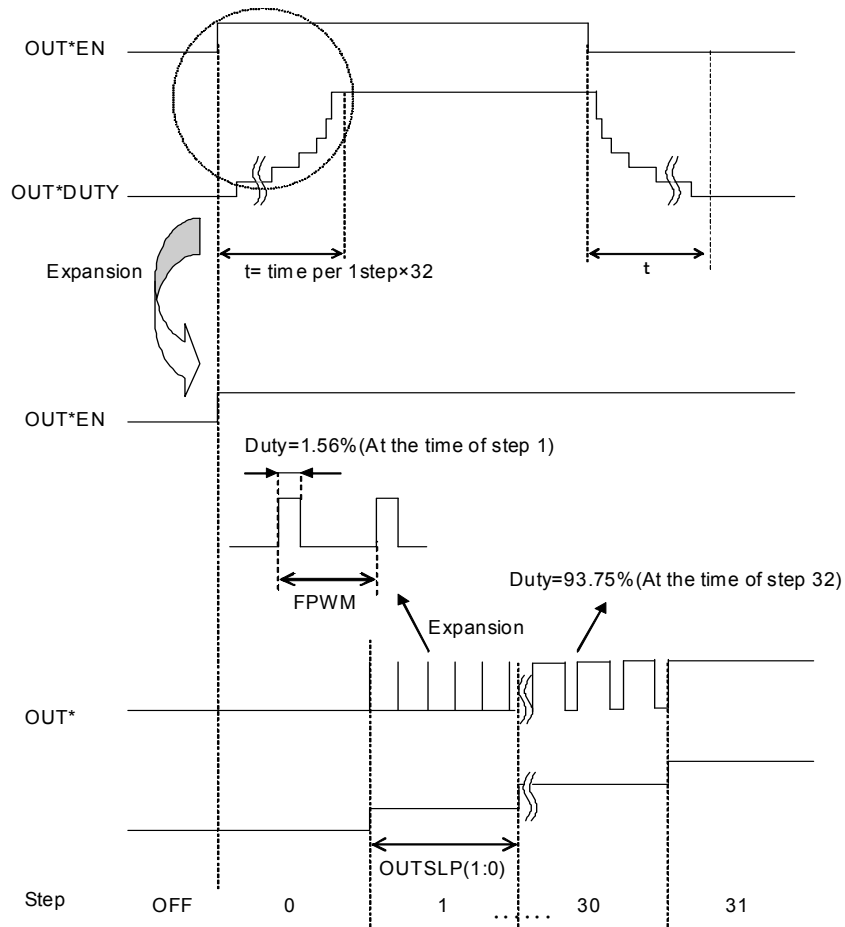
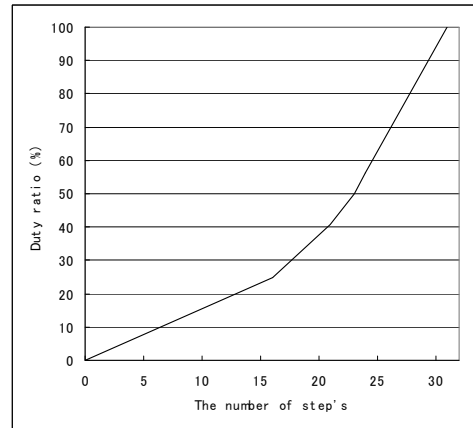

● I/O

When the RESETB pin is Low, the input buffers (SDA and SCL) are disabling for the Low consumption power.

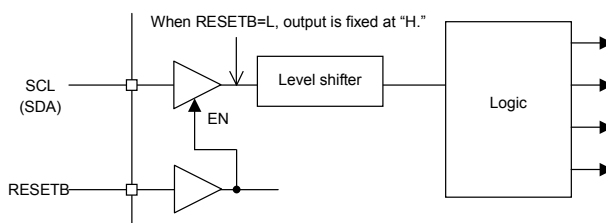

Special care should be taken because a current path may be formed via a terminal protection diode, depending on an I/O power-on sequence or an input level.

● About the pin management of the function that isn't used and test pins

Setting it as follows is recommended with the test pin and the pin which isn't used.

Set up pin referring to the "Equivalent circuit diagram" so that there may not be a problem under the actual use.

T1	Short to GND because pin for test GND
T2, T4	Short to GND because pin for test input
T3	OPEN because pin for test output
Non-used LED Pin	Short to GND (Must) But, the setup of a register concerned with LED that isn't used is prohibited.
WPWMIN, OUTCNT	Short to ground (A Pull-Down resistance built-in terminal is contained, too.)
OUT1~4	It opens for an output
KBLT	Although Pull-Down is built in, it opens for an output.

● Operation Settings (Flow Example)

1. Backlight: Auto luminous Mode

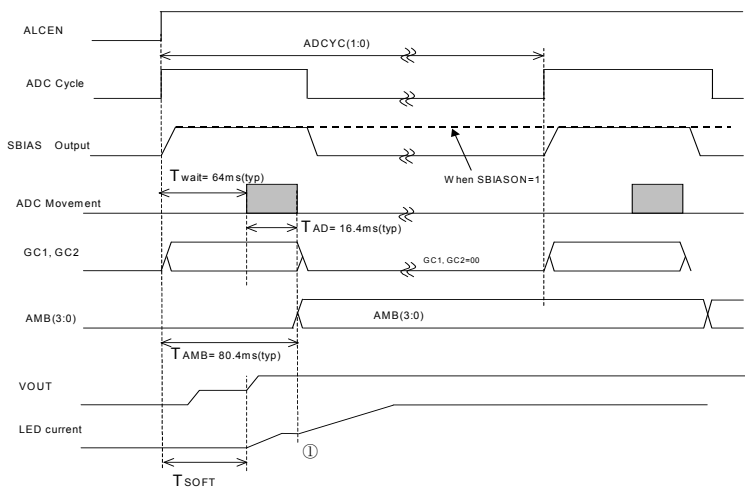
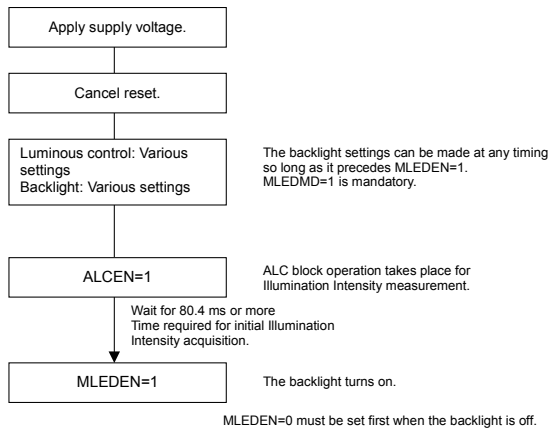

When It cannot wait for the first illumination measurement, backlight lighting is possible with ALCEN. But the extremely short case of slope rise time, a shoulder may be done like ① for an LED electric current. (To the first illumination measurement for AMB(3:0)=00h)

2. Backlight: Fade-in/Fade-out

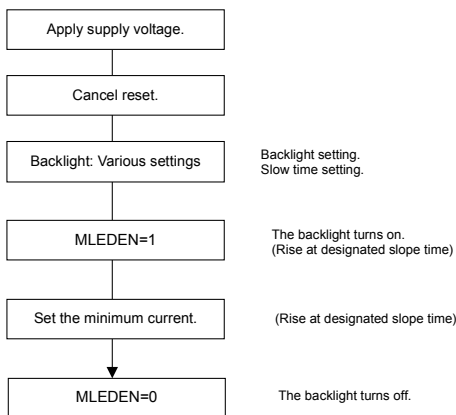

3. Backlight: Un-auto luminous Mode

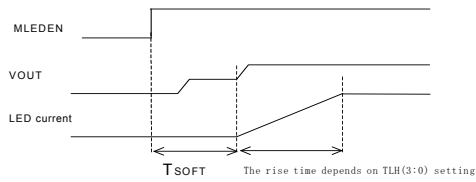
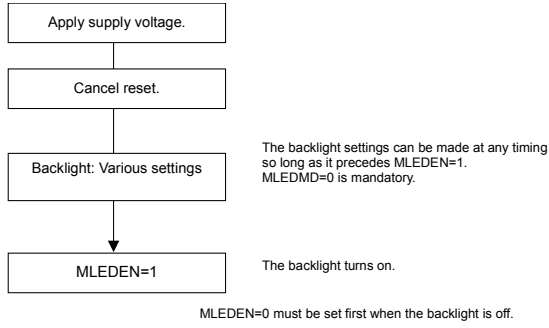

●PCB pattern of the Power dissipation measuring board

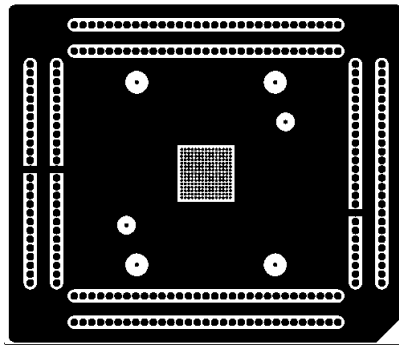

1st layer(component)

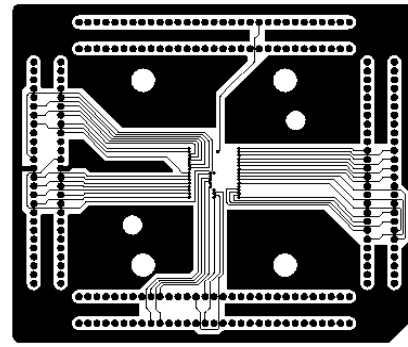

2nd layer

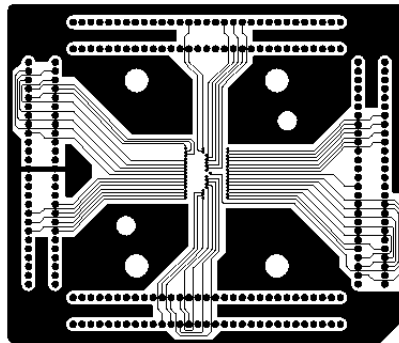

3rd layer

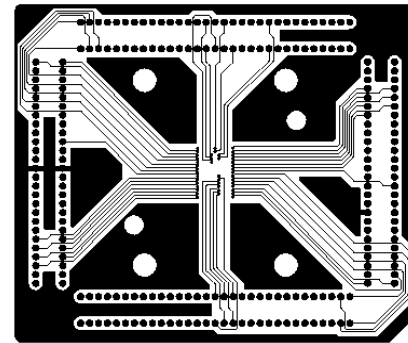

4th layer

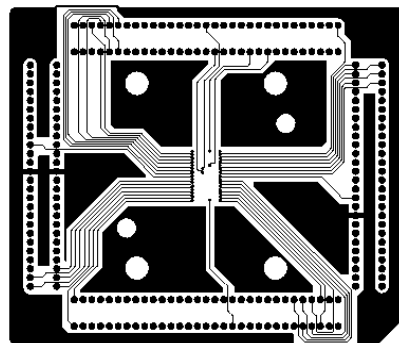

5th layer

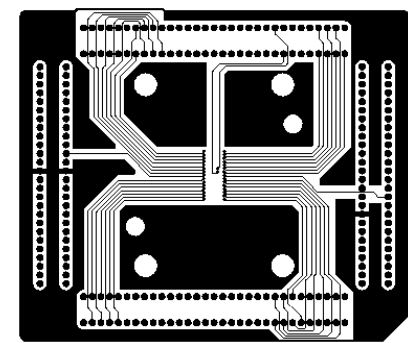

6th layer

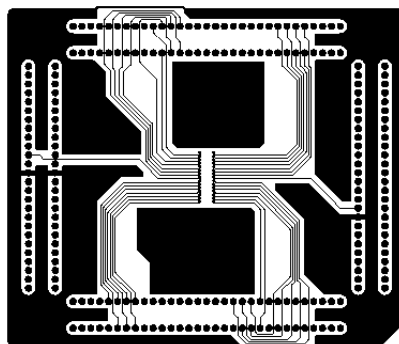

7th layer

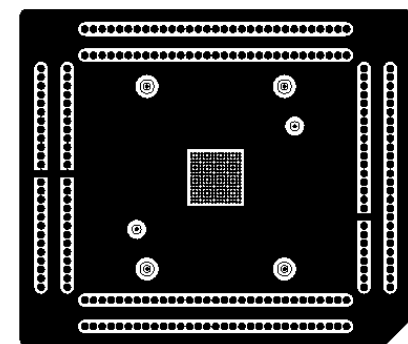

8th layer(solder)

●Notes for use**(1) Absolute Maximum Ratings**

An excess in the absolute maximum ratings, such as supply voltage, temperature range of operating conditions, etc., can break down devices, thus making impossible to identify breaking mode such as a short circuit or an open circuit. If any special mode exceeding the absolute maximum ratings is assumed, consideration should be given to take physical safety measures including the use of fuses, etc.

(2) Power supply and ground line

Design PCB pattern to provide low impedance for the wiring between the power supply and the ground lines. Pay attention to the interference by common impedance of layout pattern when there are plural power supplies and ground lines. Especially, when there are ground pattern for small signal and ground pattern for large current included the external circuits, please separate each ground pattern. Furthermore, for all power supply pins to ICs, mount a capacitor between the power supply and the ground pin. At the same time, in order to use a capacitor, thoroughly check to be sure the characteristics of the capacitor to be used present no problem including the occurrence of capacity dropout at a low temperature, thus determining the constant.

(3) Ground voltage

Make setting of the potential of the ground pin so that it will be maintained at the minimum in any operating state. Furthermore, check to be sure no pins are at a potential lower than the ground voltage including an actual electric transient.

(4) Short circuit between pins and erroneous mounting

In order to mount ICs on a set PCB, pay thorough attention to the direction and offset of the ICs. Erroneous mounting can break down the ICs. Furthermore, if a short circuit occurs due to foreign matters entering between pins or between the pin and the power supply or the ground pin, the ICs can break down.

(5) Operation in strong electromagnetic field

Be noted that using ICs in the strong electromagnetic field can malfunction them.

(6) Input pins

In terms of the construction of IC, parasitic elements are inevitably formed in relation to potential. The operation of the parasitic element can cause interference with circuit operation, thus resulting in a malfunction and then breakdown of the input pin. Therefore, pay thorough attention not to handle the input pins, such as to apply to the input pins a voltage lower than the ground respectively, so that any parasitic element will operate. Furthermore, do not apply a voltage to the input pins when no power supply voltage is applied to the IC. In addition, even if the power supply voltage is applied, apply to the input pins a voltage lower than the power supply voltage or within the guaranteed value of electrical characteristics.

(7) External capacitor

In order to use a ceramic capacitor as the external capacitor, determine the constant with consideration given to a degradation in the nominal capacitance due to DC bias and changes in the capacitance due to temperature, etc.

(8) Thermal shutdown circuit (TSD)

This LSI builds in a thermal shutdown (TSD) circuit. When junction temperatures become detection temperature or higher, the thermal shutdown circuit operates and turns a switch OFF. The thermal shutdown circuit, which is aimed at isolating the LSI from thermal runaway as much as possible, is not aimed at the protection or guarantee of the LSI. Therefore, do not continuously use the LSI with this circuit operating or use the LSI assuming its operation.

(9) Thermal design

Perform thermal design in which there are adequate margins by taking into account the permissible dissipation (Pd) in actual states of use.

(10) LDO

Use each output of LDO by the independence. Don't use under the condition that each output is short-circuited because it has the possibility that an operation becomes unstable.

(11) About the pin for the test, the un-use pin

Prevent a problem from being in the pin for the test and the un-use pin under the state of actual use. Please refer to a function manual and an application notebook. And, as for the pin that doesn't specially have an explanation, ask our company person in charge.

(12) About the rush current

For ICs with more than one power supply, it is possible that rush current may flow instantaneously due to the internal powering sequence and delays. Therefore, give special consideration to power coupling capacitance, power wiring, width of ground wiring, and routing of wiring.

(13) About the function description or application note or more.

The function description and the application notebook are the design materials to design a set. So, the contents of the materials aren't always guaranteed. Please design application by having fully examination and evaluation include the external elements.

●Power dissipation (On the ROHM's standard board)

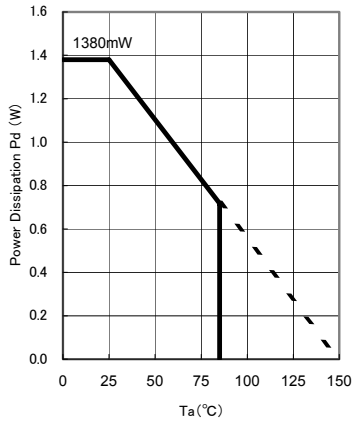

Information of the ROHM's standard board
 Material : glass-epoxy
 Size : 50mm×58mm×1.75mm(8th layer)
 Wiring pattern figure Refer to after page.

● Ordering part number

B	D
---	---

Part No.

6	0	8	8
---	---	---	---

Part No.
6088

G	U	L
---	---	---

Package
GUL : VCSP50L3

E	2
---	---

Packaging and forming specification
E2: Embossed tape and reel

VCSP50L3(BD6088GUL)

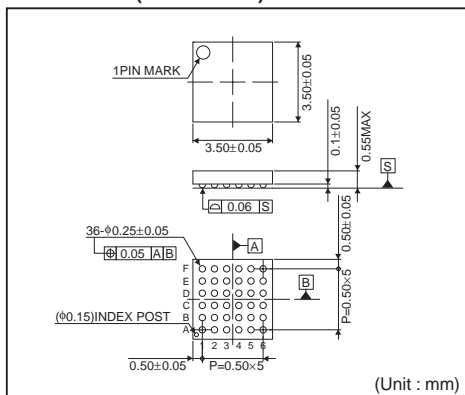

<Tape and Reel information>

Tape	Embossed carrier tape
Quantity	2500pcs
Direction of feed	E2 (The direction is the 1 pin of product is at the upper left when you hold reel on the left hand and you pull out the tape on the right hand)

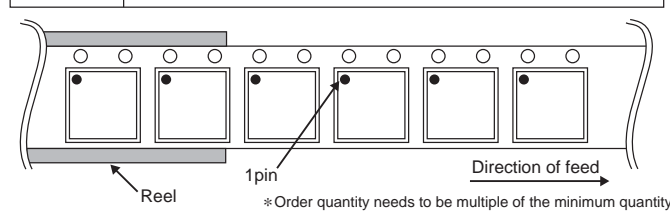

Notes

No copying or reproduction of this document, in part or in whole, is permitted without the consent of ROHM Co.,Ltd.

The content specified herein is subject to change for improvement without notice.

The content specified herein is for the purpose of introducing ROHM's products (hereinafter "Products"). If you wish to use any such Product, please be sure to refer to the specifications, which can be obtained from ROHM upon request.

Examples of application circuits, circuit constants and any other information contained herein illustrate the standard usage and operations of the Products. The peripheral conditions must be taken into account when designing circuits for mass production.

Great care was taken in ensuring the accuracy of the information specified in this document. However, should you incur any damage arising from any inaccuracy or misprint of such information, ROHM shall bear no responsibility for such damage.

The technical information specified herein is intended only to show the typical functions of and examples of application circuits for the Products. ROHM does not grant you, explicitly or implicitly, any license to use or exercise intellectual property or other rights held by ROHM and other parties. ROHM shall bear no responsibility whatsoever for any dispute arising from the use of such technical information.

The Products specified in this document are intended to be used with general-use electronic equipment or devices (such as audio visual equipment, office-automation equipment, communication devices, electronic appliances and amusement devices).

The Products specified in this document are not designed to be radiation tolerant.

While ROHM always makes efforts to enhance the quality and reliability of its Products, a Product may fail or malfunction for a variety of reasons.

Please be sure to implement in your equipment using the Products safety measures to guard against the possibility of physical injury, fire or any other damage caused in the event of the failure of any Product, such as derating, redundancy, fire control and fail-safe designs. ROHM shall bear no responsibility whatsoever for your use of any Product outside of the prescribed scope or not in accordance with the instruction manual.

The Products are not designed or manufactured to be used with any equipment, device or system which requires an extremely high level of reliability the failure or malfunction of which may result in a direct threat to human life or create a risk of human injury (such as a medical instrument, transportation equipment, aerospace machinery, nuclear-reactor controller, fuel-controller or other safety device). ROHM shall bear no responsibility in any way for use of any of the Products for the above special purposes. If a Product is intended to be used for any such special purpose, please contact a ROHM sales representative before purchasing.

If you intend to export or ship overseas any Product or technology specified herein that may be controlled under the Foreign Exchange and the Foreign Trade Law, you will be required to obtain a license or permit under the Law.



Thank you for your accessing to ROHM product informations.
More detail product informations and catalogs are available, please contact us.

ROHM Customer Support System

<http://www.rohm.com/contact/>