

FSBH0F70A _F116, FSBH0170_F116, FSBH0270_F116, FSBH0370_F116 Green Mode Fairchild Power Switch (FPS™)

Features

- Brownout Protection with Hysteresis
- Built-In 5ms Soft-Start Function
- Internal Avalanche-Rugged 700V SenseFET
- Low Acoustic Noise During Light-Load Operation
- High-Voltage Startup
- Linearly Decreasing PWM Frequency to 18KHz
- Peak-Current-Mode Control
- Cycle-by-Cycle Current Limiting
- Leading-Edge Blanking (LEB)
- Synchronized Slope Compensation
- Internal Open-Loop Protection
- V_{DD} Under-Voltage Lockout (UVLO)
- V_{DD} Over-Voltage Protection (OVP)
- Internal Auto-Restart Circuit (OVP, OTP)
- Constant Power Limit (Full AC Input Range)
- Internal OTP Sensor with Hysteresis
- VIN Pin for Pull-HIGH Latch Function and Pull-LOW Auto-Recovery Protection

Applications

General-purpose switched-mode power supplies and flyback power converters, including:

- Auxiliary Power Supply for PC and Server
- SMPS for VCR, SVR, STB, DVD & DVCD Player, Printer, Facsimile, and Scanner
- Adapter for Camcorder

Description

The highly integrated FSBH-series consists of an integrated current-mode Pulse Width Modulator (PWM) and an avalanche-rugged 700V SenseFET. It is specifically designed for high-performance offline Switched-Mode Power Supplies (SMPS) with minimal external components.

The integrated PWM controller features include a proprietary green-mode function that provides off-time modulation to linearly decrease the switching frequency at light-load conditions to minimize standby power consumption. To avoid acoustic-noise problems, the minimum PWM frequency is set above 18kHz. This green-mode function enables the power supply to meet international power conservation requirements. The PWM controller is manufactured using the BiCMOS process to further reduce power consumption. The FSBH-series turns off some internal circuits to improve power saving when V_{FB} is lower than 1.6V, which allows an operating current of only 2.5mA.

The FSBH-series has built-in synchronized slope compensation to achieve stable peak-current-mode control. The proprietary external line compensation ensures constant output power limit over a wide AC input voltage range, from 90V_{AC} to 264V_{AC}.

The FSBH-series provides many protection functions. In addition to cycle-by-cycle current limiting, the internal open-loop protection circuit ensures safety when an open-loop or output short occurs. PWM output is disabled until V_{DD} drops below the V_{TH-OLP}, then the controller starts up again. As long as V_{DD} exceeds 28V, the internal OVP circuit is triggered.

Compared with a discrete MOSFET and controller or RCC switching converter solution, the FSBH-series reduces component count, design size, and weight; while increasing efficiency, productivity, and system reliability. These devices provide a basic platform that is well suited for the design of cost-effective flyback converters, such as in PC auxiliary power supplies.

Ordering Information

| Part Number | SenseFET | VIN Pin (PIN #4) | Operating Temperature Range | Package | Packing Method |
|------------------|-----------|------------------|-----------------------------|-----------------------------------|----------------|
| FSBH0F70ANY_F116 | 0.5A 700V | Not Available | -40°C to +105°C | 8-Pin, Dual In-Line Package (DIP) | Tube |
| FSBH0170NY_F116 | 1.0A 700V | Enabled | | | |
| FSBH0270NY_F116 | 2.0A 700V | | | | |
| FSBH0370NY_F116 | 3.0A 700V | | | | |

Typical Application Diagram

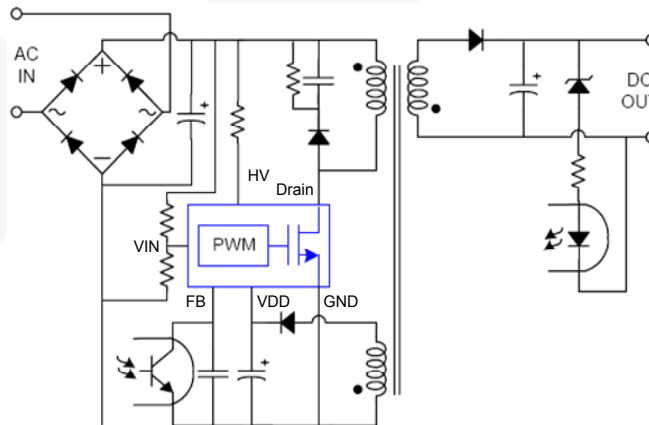

Figure 1. Typical Flyback Application

Output Power Table⁽¹⁾

| Product | 230V _{AC} ± 15% ⁽²⁾ | | 85-265V _{AC} | |
|----------------|---|---------------------------|------------------------|---------------------------|
| | Adapter ⁽³⁾ | Open Frame ⁽⁴⁾ | Adapter ⁽³⁾ | Open Frame ⁽⁴⁾ |
| FSBH0F70A_F116 | 7W | 10W | 6W | 8W |
| FSBH0170_F116 | 10W | 15W | 9W | 13W |
| FSBH0270_F116 | 14W | 20W | 11W | 16W |
| FSBH0370_F116 | 17.5W | 25W | 13W | 19W |

Notes:

1. The maximum output power can be limited by junction temperature.
2. 230 V_{AC} or 100/115 V_{AC} with doublers.
3. Typical continuous power in a non-ventilated enclosed adapter with sufficient drain pattern as a heat sink at 50°C ambient.
4. Maximum practical continuous power in an open-frame design with sufficient drain pattern as a heat sink at 50°C ambient.

Block Diagram

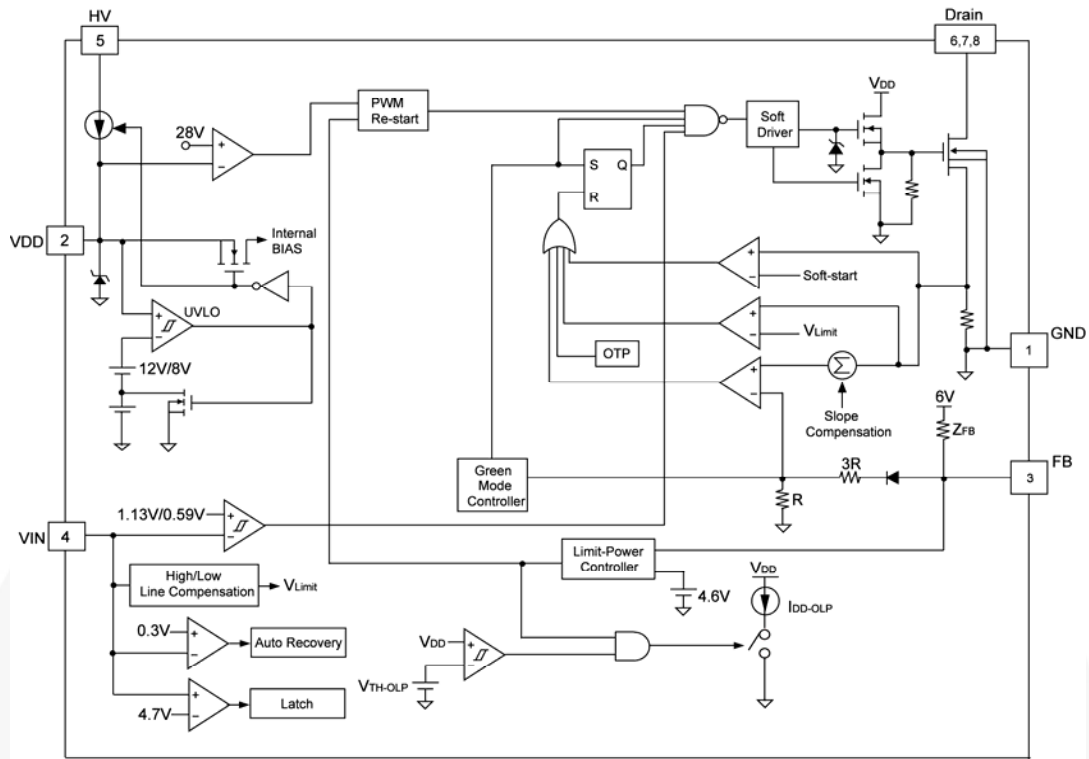

Figure 2. FSBH0170/0270/0370_F116 Internal Block Diagram

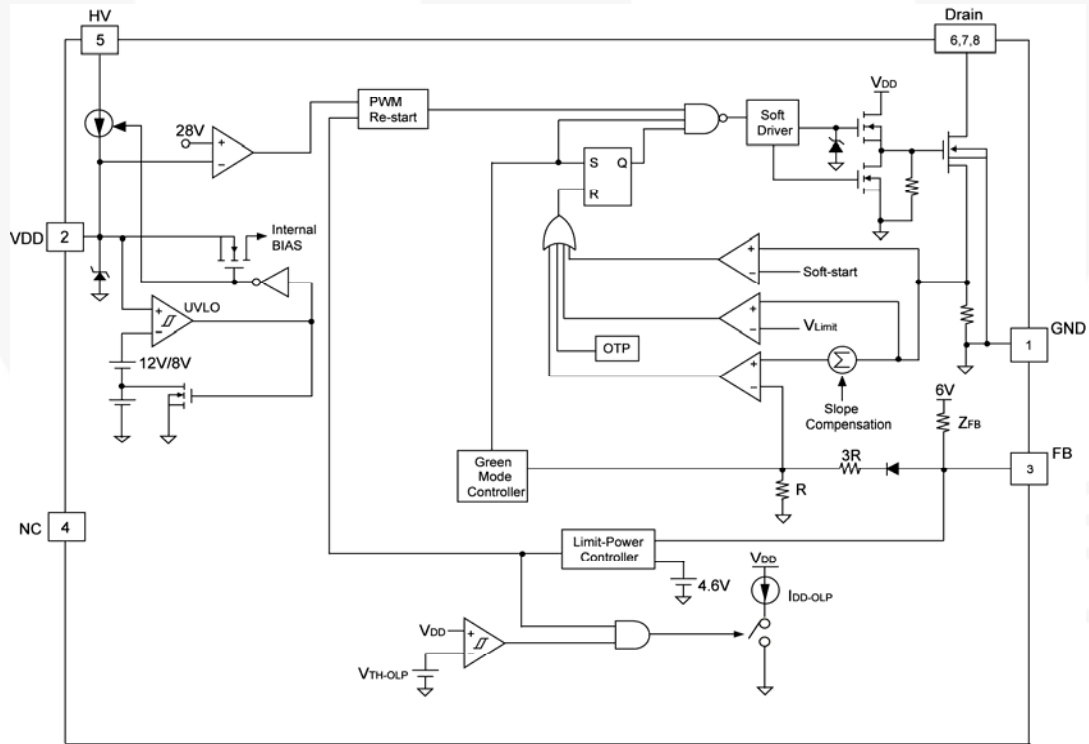

Figure 3. FSBH0F70A_F116 Internal Block Diagram

Pin Configuration

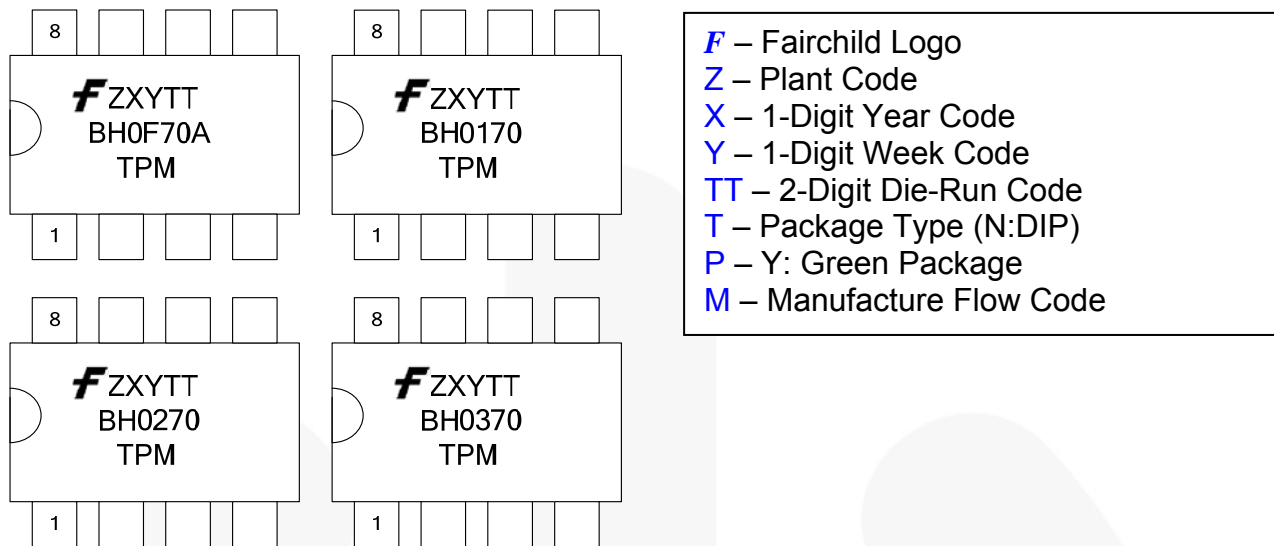

Figure 4. Pin Configuration and Top Mark Information

Pin Definitions

| Pin # | Name | Description |
|-------|-------|---|
| 1 | GND | Ground. SenseFET source terminal on primary side and internal controller ground. |
| 2 | VDD | Power Supply. The internal protection circuit disables PWM output as long as V_{DD} exceeds the OVP trigger point. |
| 3 | FB | Feedback. The signal from the external compensation circuit is fed into this pin. The PWM duty cycle is determined in response to the signal on this pin and the internal current-sense signal. |
| 4 | VIN | Line-Voltage Detection. The line-voltage detection is used for brownout protection with hysteresis and constant output power limit over universal AC input range. This pin has additional protections that are pull-HIGH latch and pull-LOW auto recovery, depending on the application. |
| | NC | No Connection. FSBH0F70A_F116 |
| 5 | HV | Startup. For startup, this pin is pulled HIGH to the line input or bulk capacitor via resistors. |
| 6 | Drain | SenseFET Drain. High-voltage power SenseFET drain connection. |
| 7 | Drain | SenseFET Drain. High-voltage power SenseFET drain connection. |
| 8 | Drain | SenseFET Drain. High-voltage power SenseFET drain connection. |

Absolute Maximum Ratings

Stresses exceeding the absolute maximum ratings may damage the device. The device may not function or be operable above the recommended operating conditions and stressing the parts to these levels is not recommended. In addition, extended exposure to stresses above the recommended operating conditions may affect device reliability. The absolute maximum ratings are stress ratings only.

| Symbol | Parameter | | Min. | Max. | Unit |
|--------------------|---|-----------------|------------------------------------|------|------|
| V _{DRAIN} | Drain Pin Voltage ^(5,6) | FSBH0x70/A_F116 | | 700 | V |
| I _{DM} | Drain Current Pulsed ⁽⁷⁾ | FSBH0F70A_F116 | | 1.5 | A |
| | | FSBH0170_F116 | | 4.0 | |
| | | FSBH0270_F116 | | 8.0 | |
| | | FSBH0370_F116 | | 12.0 | |
| E _{AS} | Single Pulsed Avalanche Energy ⁽⁸⁾ | FSBH0F70A_F116 | | 10 | mJ |
| | | FSBH0170_F116 | | 50 | |
| | | FSBH0270_F116 | | 140 | |
| | | FSBH0370_F116 | | 230 | |
| V _{DD} | DC Supply Voltage | | | 30 | V |
| V _{FB} | FB Pin Input Voltage | | -0.3 | 7.0 | V |
| V _{IN} | VIN Pin Input Voltage | | -0.3 | 7.0 | V |
| V _{HV} | HV Pin Input Voltage | | | 700 | V |
| P _D | Power Dissipation (T _A < 50°C) | | | 1.5 | W |
| Θ _{JA} | Junction-to-Air Thermal Resistance | | | 80 | °C/W |
| ψ _{JT} | Junction-to-Top Thermal Resistance ⁽⁹⁾ | | | 20 | °C/W |
| T _J | Operating Junction Temperature | | Internally limited ⁽¹⁰⁾ | | °C |
| T _{STG} | Storage Temperature Range | | -55 | +150 | °C |
| T _L | Lead Temperature (Wave Soldering or IR, 10 Seconds) | | | +260 | °C |
| ESD | Human Body Model (All Pins Except HV pin): JESD22-A114 | FSBH0F70A_F116 | 5.0 | | kV |
| | | FSBH0170_F116 | 5.0 | | |
| | | FSBH0270_F116 | 5.0 | | |
| | | FSBH0370_F116 | 5.0 | | |
| | Charged Device Model (All Pins Except HV pin): JESD22-C101 | FSBH0F70A_F116 | 2.0 | | |
| | | FSBH0170_F116 | 2.0 | | |
| | | FSBH0270_F116 | 2.0 | | |
| | | FSBH0370_F116 | 1.5 | | |

Notes:

5. All voltage values, except differential voltages, are given with respect to the network ground terminal.
6. Stresses beyond those listed under Absolute Maximum Ratings may cause permanent damage to the device.
7. Non-repetitive rating: pulse width is limited by maximum junction temperature.
8. L = 51mH, starting T_J = 25°C.
9. Measured on the package top surface.
10. Internally Limited of T_J refers to T_{OTP}

Recommended Operating Conditions

The Recommended Operating Conditions table defines the conditions for actual device operation. Recommended operating conditions are specified to ensure optimal performance to the datasheet specifications. Fairchild does not recommend exceeding them or designing to Absolute Maximum Ratings.

| Symbol | Parameter | Min. | Max. | Unit |
|----------------|-------------------------------|------|------|------|
| T _A | Operating Ambient Temperature | -40 | +105 | °C |

Electrical Characteristics

$V_{DD}=15V$ and $T_A=25^\circ C$ unless otherwise specified.

| Symbol | Parameter | Condition | Min. | Typ. | Max. | Unit |
|-------------------------|--|---|----------------|-------|-------|----------|
| SenseFET Section | | | | | | |
| BV_{DSS} | Drain-Source Breakdown Voltage | $V_{DS}=700V, V_{GS}=0V$ | 700 | | | V |
| I_{DSS} | Zero-Gate-Voltage Drain Current | $V_{DS}=700V, V_{GS}=0V$ | | | 50 | μA |
| | | $V_{DS}=560V, V_{GS}=0V, T_C=125^\circ C$ | | | 200 | |
| $R_{DS(ON)}$ | Drain-Source On-State Resistance ⁽¹²⁾ | $V_{GS}=10V, I_D=0.5A$ | FSBH0F70A_F116 | 14.00 | 19.00 | Ω |
| | | | FSBH0170_F116 | 8.80 | 11.00 | |
| | | | FSBH0270_F116 | 6.00 | 7.20 | |
| | | | FSBH0370_F116 | 4.00 | 4.75 | |
| C_{ISS} | Input Capacitance | $V_{GS}=0V, V_{DS}=25V, f=1MHz$ | FSBH0F70A_F116 | 162 | 211 | pF |
| | | | FSBH0170_F116 | 250 | 325 | |
| | | | FSBH0270_F116 | 550 | 715 | |
| | | | FSBH0370_F116 | 315 | 410 | |
| C_{OSS} | Output Capacitance | $V_{GS}=0V, V_{DS}=25V, f=1MHz$ | FSBH0F70A_F116 | 18 | 24 | pF |
| | | | FSBH0170_F116 | 25 | 33 | |
| | | | FSBH0270_F116 | 38 | 50 | |
| | | | FSBH0370_F116 | 47 | 61 | |
| C_{RSS} | Reverse Transfer Capacitance | $V_{GS}=0V, V_{DS}=25V, f=1MHz$ | FSBH0F70A_F116 | 3.8 | 5.7 | pF |
| | | | FSBH0170_F116 | 10.0 | 15.0 | |
| | | | FSBH0270_F116 | 17.0 | 26.0 | |
| | | | FSBH0370_F116 | 9.0 | 24.0 | |
| $t_{D(ON)}$ | Turn-On Delay | $V_{DS}=350V, I_D=1.0A$ | FSBH0F70A_F116 | 9.5 | 29.0 | ns |
| | | | FSBH0170_F116 | 12.0 | 34.0 | |
| | | | FSBH0270_F116 | 20.0 | 50.0 | |
| | | | FSBH0370_F116 | 11.2 | 33.0 | |
| t_R | Rise Time | $V_{DS}=350V, I_D=1.0A$ | FSBH0F70A_F116 | 19 | 48 | ns |
| | | | FSBH0170_F116 | 4 | 18 | |
| | | | FSBH0270_F116 | 15 | 40 | |
| | | | FSBH0370_F116 | 34 | 78 | |
| $t_{D(OFF)}$ | Turn-Off Delay | $V_{DS}=350V, I_D=1.0A$ | FSBH0F70A_F116 | 33.0 | 76.0 | ns |
| | | | FSBH0170_F116 | 30.0 | 70.0 | |
| | | | FSBH0270_F116 | 55.0 | 120.0 | |
| | | | FSBH0370_F116 | 28.2 | 67.0 | |
| t_F | Fall Time | $V_{DS}=350V, I_D=1.0A$ | FSBH0F70A_F116 | 42 | 94 | ns |
| | | | FSBH0170_F116 | 10 | 30 | |
| | | | FSBH0270_F116 | 25 | 60 | |
| | | | FSBH0370_F116 | 32 | 74 | |

Continued on the following page...

Electrical Characteristics (Continued)

 $V_{DD}=15V$ and $T_A=25^{\circ}C$ unless otherwise specified.

| Symbol | Parameter | Condition | Min. | Typ. | Max. | Unit |
|-------------------------------|---|--|---------------------|-------|-------|------------|
| Control Section | | | | | | |
| V_{DD} Section | | | | | | |
| V_{DD-ON} | Start Threshold Voltage | | 11 | 12 | 13 | V |
| V_{DD-OFF} | Minimum Operating Voltage | | 7 | 8 | 9 | V |
| I_{DD-ST} | Startup Current | FSBH0170_F116 | $V_{DD-ON} - 0.16V$ | | | μA |
| | | FSBH0270_F116 | | | | |
| | | FSBH0370_F116 | | | | |
| | | FSBH0F70A_F116 | $V_{DD-ON} - 0.16V$ | 240 | 320 | 400 |
| I_{DD-OP} | Operating Supply Current | $V_{DD}=15V, V_{FB}=3V$ | 3.0 | 3.5 | 4.0 | mA |
| I_{DD-ZDC} | Operating Current for $V_{FB} < V_{FB-ZDC}$ | $V_{DD}=12V, V_{FB}=1.6V$ | 1.5 | 2.5 | 3.5 | mA |
| I_{DD-OLP} | Internal Sink Current | $V_{TH-OLP} + 0.1V$ | 30 | 70 | 90 | μA |
| V_{TH-OLP} | I_{DD-OLP} Off Voltage | | 5 | 6 | 7 | V |
| V_{DD-OVP} | V_{DD} Over-Voltage Protection | | 27 | 28 | 29 | V |
| $t_{D-VDD-OVP}$ | V_{DD} Over-Voltage Protection Debounce Time | | 75 | 130 | 200 | μs |
| HV Section | | | | | | |
| I_{HV} | Maximum Current Drawn from HV Pin | HV 120V _{DC} , $V_{DD}=0V$ with 10 μF | 1.5 | 3.5 | 5.0 | mA |
| I_{HV-LC} | Leakage Current after Startup | HV=700V, $V_{DD}=V_{DD-OFF}+1V$ | | 1 | 20 | μA |
| Oscillator Section | | | | | | |
| f_{OSC} | Frequency in Nominal Mode | Center Frequency | 94 | 100 | 106 | kHz |
| f_{OSC-G} | Green-Mode Frequency | | 14 | 18 | 22 | kHz |
| D_{MAX} | Maximum Duty Cycle | | | 85 | | % |
| f_{DV} | Frequency Variation vs. V_{DD} Deviation | $V_{DD}=11V$ to 22V | | | 5 | % |
| f_{DT} | Frequency Variation vs. Temperature Deviation ⁽¹¹⁾ | $T_A=-25$ to 85 $^{\circ}C$ | | | 5 | % |
| V_{IN} Section | | | | | | |
| V_{IN-ON} | PWM Turn-On Threshold Voltage | | 1.08 | 1.13 | 1.18 | V |
| V_{IN-OFF} | PWM Turn-Off Threshold Voltage | | 0.50 | 0.55 | 0.60 | V |
| t_{IN-OFF} | PWM Turn-Off Debounce Time | | | 500 | | ms |
| V_{IN-H} | Pull-HIGH Latch Trigger Level | | 4.4 | 4.7 | 5.0 | V |
| t_{IN-H} | Pull-HIGH Latch Debounce Time | | | 100 | | μs |
| V_{IN-L} | Pull-LOW Auto-Recovery Trigger Level | | 0.2 | 0.3 | 0.4 | V |
| Feedback Input Section | | | | | | |
| A_V | FB Voltage to Current-Sense Attenuation | | 1/4.5 | 1/4.0 | 1/3.5 | V/V |
| Z_{FB} | Input Impedance | | 4 | | 7 | k Ω |
| $V_{FB-OPEN}$ | Output High Voltage | FB Pin Open | 5.5 | | | V |

Continued on the following page...

Electrical Characteristics (Continued)

V_{DD}=15V and T_A=25°C unless otherwise specified.

| Symbol | Parameter | | Condition | Min. | Typ. | Max. | Unit |
|--|--|----------------|-----------------------|------|----------------------|------|------|
| V _{FB-N} | Green-Mode Entry FB Voltage | | | 2.3 | 2.5 | 2.7 | V |
| V _{FB-G} | Green-Mode Ending FB Voltage | | | 1.9 | 2.0 | 2.1 | V |
| V _{FB-ZDC} | Zero Duty Cycle FB Voltage | | | | 1.6 | | V |
| V _{FB-OLP} | FB Open-Loop Trigger Level | FSBH0F70A_F116 | | 5.2 | 5.4 | 5.6 | V |
| | | FSBH0x70_F116 | | 4.4 | 4.6 | 4.8 | |
| t _{D-OLP} | FB Open-Loop Protection Delay | | | 50 | 56 | 59 | ms |
| Current-Sense Section⁽¹⁵⁾ | | | | | | | |
| I _{LIM} | Peak Current Limit | FSBH0F70A_F116 | V _{IN} Open | 0.63 | 0.73 | 0.83 | A |
| | | FSBH0170_F116 | V _{IN} =1.2V | 0.70 | 0.80 | 0.90 | |
| | | FSBH0270_F116 | V _{IN} =1.2V | 0.90 | 1.00 | 1.10 | |
| | | FSBH0370_F116 | V _{IN} =1.2V | 1.10 | 1.20 | 1.30 | |
| t _{SS} | Period During Soft-Start Time ⁽¹¹⁾ | | | 4.5 | 5.0 | 5.5 | ms |
| Constant Power Limit (FSBH0170, FSBH0270, FSBH0370) | | | | | | | |
| V _{LMT1} | Threshold Voltage 1 for Current Limit | | V _{IN} =1.2V | 0.73 | 0.80 | 0.87 | V |
| V _{LMT2} | Threshold Voltage 2 for Current Limit | | V _{IN} =3.6V | 0.56 | 0.63 | 0.70 | V |
| Constant Power Limit (FSBH0F70A) | | | | | | | |
| V _{LMT} | Threshold Voltage for Current Limit | | | 0.97 | 1.00 | 1.03 | V |
| Over-Temperature Protection Section (OTP) | | | | | | | |
| T _{OTP} | Protection Junction Temperature ^(11,13) | | | +135 | +142 | +150 | °C |
| T _{RESTART} | Restart Junction Temperature ^(11,14) | | | | T _{OTP} -25 | | °C |

Notes:

11. These parameters, although guaranteed, are not 100% tested in production.
12. Pulse test: pulse width ≤ 300µs, duty ≤ 2%.
13. When activated, the output is disabled and the latch is turned off.
14. The threshold temperature for enabling the output again and resetting the latch after over-temperature protection has been activated.
15. These parameters, although guaranteed, are tested in wafer process.

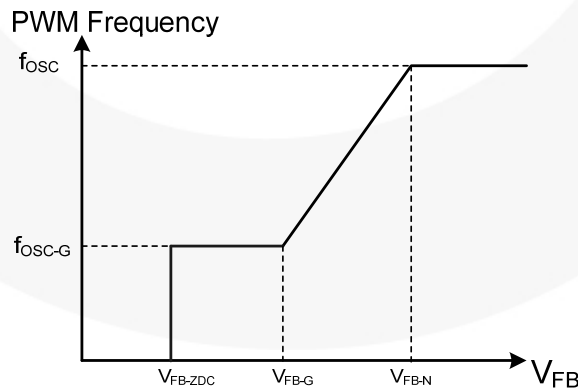

Figure 5. V_{FB} vs. PWM Frequency

Typical Characteristics

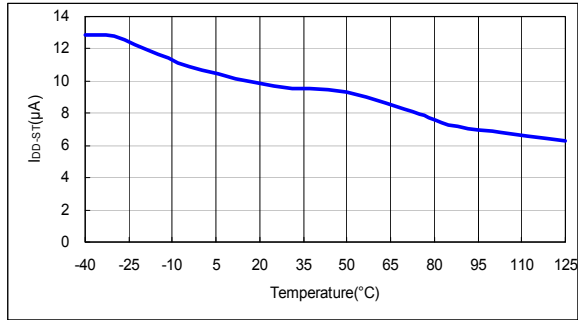

Figure 6. I_{DD-ST} vs. Temperature

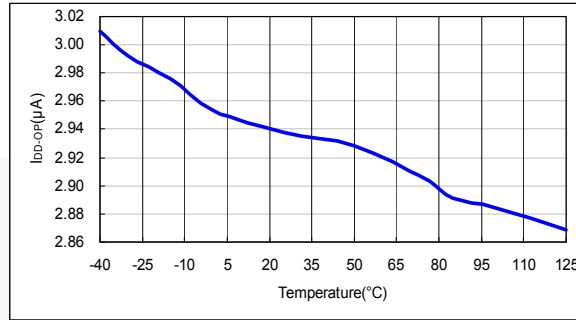

Figure 7. I_{DD-OP} vs. Temperature

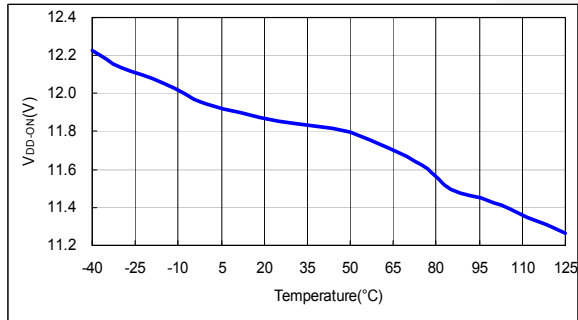

Figure 8. V_{DD-ON} vs. Temperature

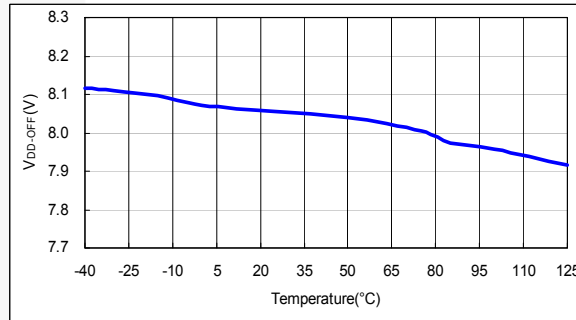

Figure 9. V_{DD-OFF} vs. Temperature

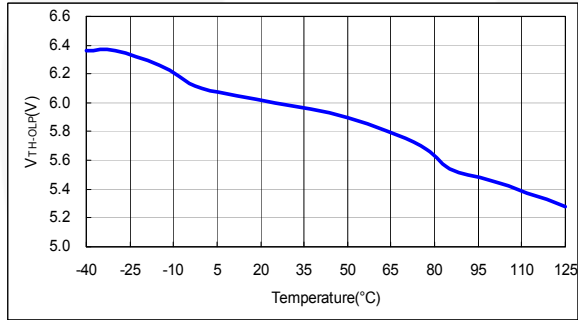

Figure 10. V_{TH-OLP} vs. Temperature

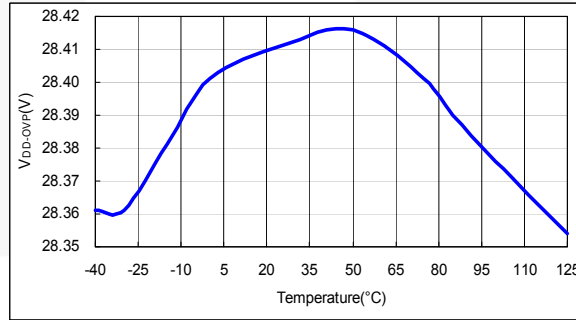

Figure 11. V_{DD-OVP} vs. Temperature

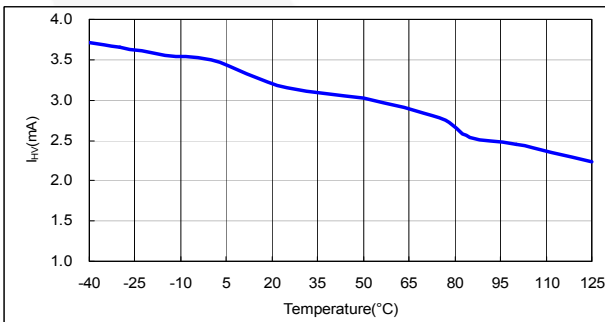

Figure 12. I_{HV} vs. Temperature

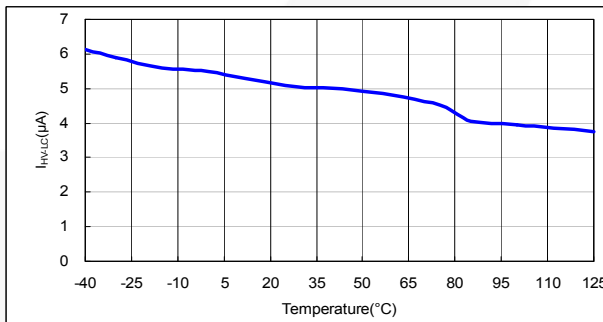

Figure 13. I_{HV-LC} vs. Temperature

Typical Characteristics

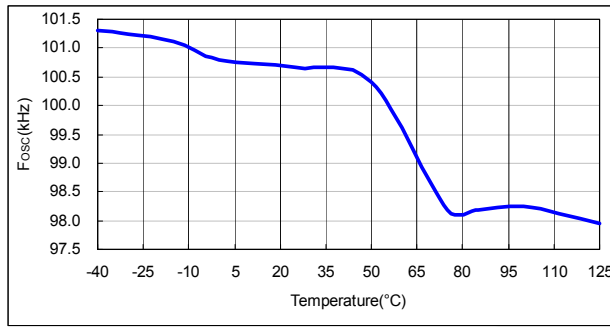

Figure 14. f_{OSC} vs. Temperature

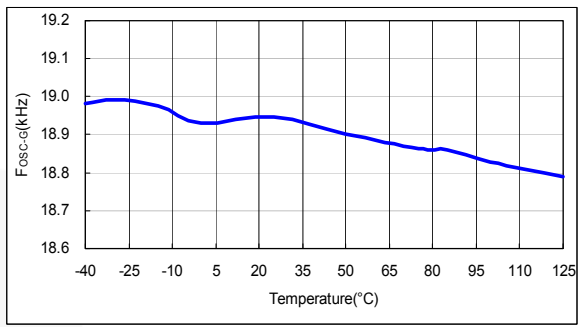

Figure 15. f_{OSC-G} vs. Temperature

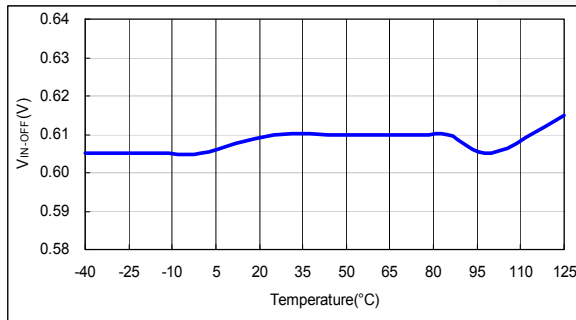

Figure 16. V_{IN-OFF} vs. Temperature

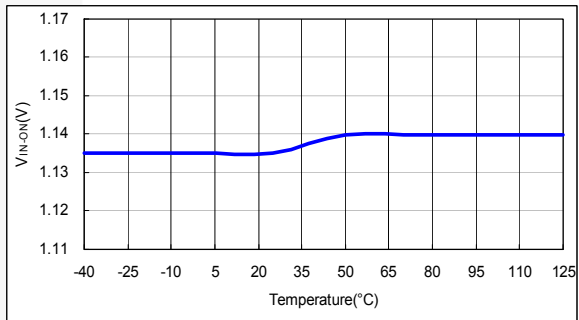

Figure 17. V_{IN-ON} vs. Temperature

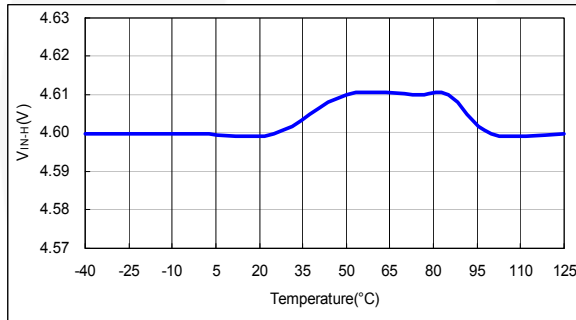

Figure 18. V_{IN-H} vs. Temperature

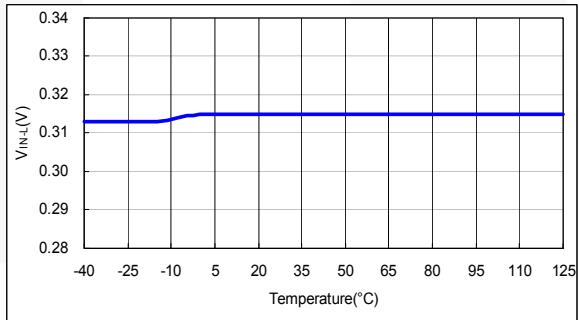

Figure 19. V_{IN-L} vs. Temperature

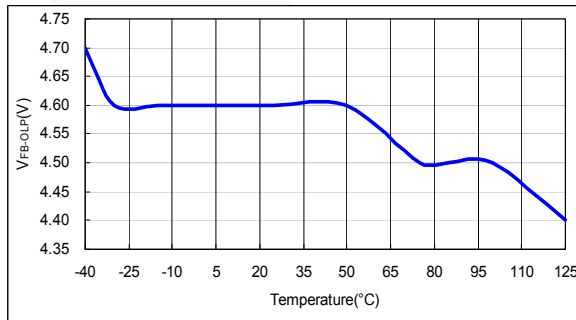

Figure 20. V_{FB-OLP} vs. Temperature

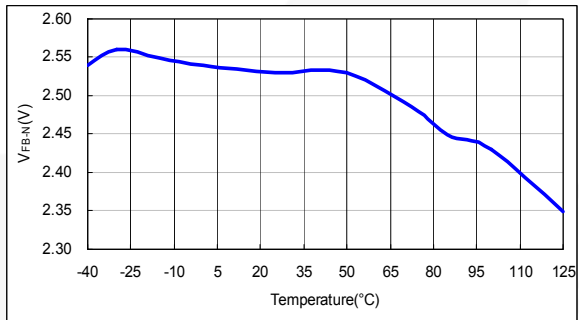

Figure 21. V_{FB-N} vs. Temperature

Typical Characteristics

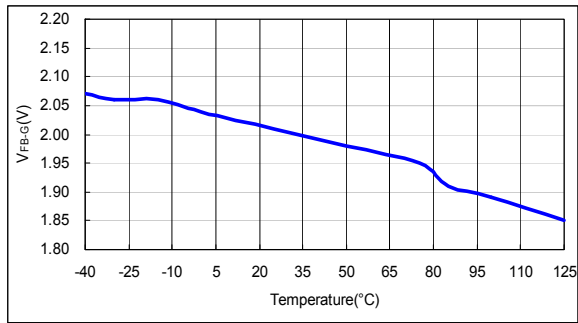

Figure 22. V_{FB-G} vs. Temperature

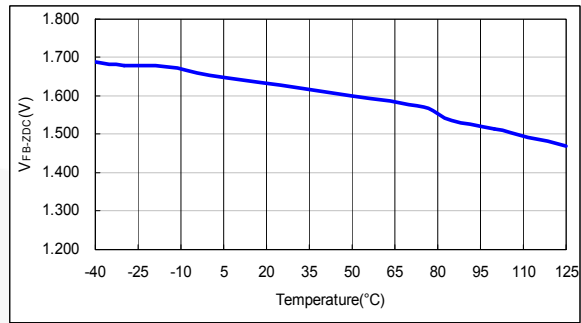

Figure 23. V_{FB-ZDC} vs. Temperature

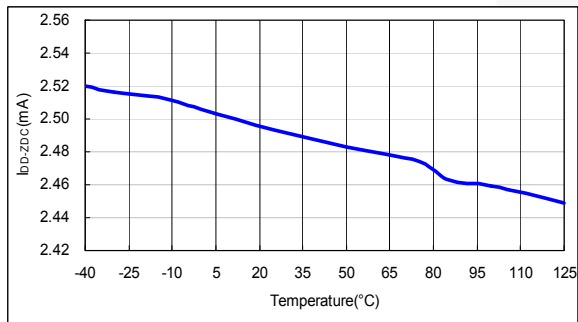

Figure 24. I_{DD-ZDC} vs. Temperature

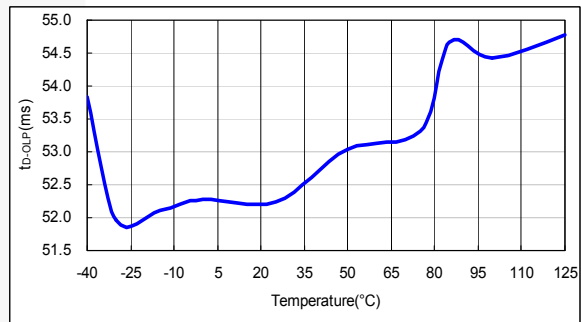

Figure 25. t_{D-OLP} vs. Temperature

Functional Description

Startup Operation

The HV pin is connected to bulk voltage through an external resistor, R_{HV} , as shown in Figure 26. When AC voltage is applied to the power system, an internal HV startup circuit provides a high current (around 3.5mA) to charge an external V_{DD} capacitor until V_{DD} voltage exceeds the turn-on threshold voltage (V_{DD-ON}). For lower power consumption, the HV startup circuit shuts down during normal operation. The external V_{DD} capacitor and auxiliary winding maintain the V_{DD} voltage and provide operating current to controller.

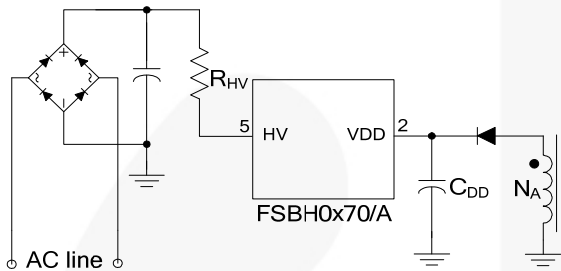

Figure 26. Startup Circuit

Slope Compensation

The FSBH-series is designed for flyback power converters. The peak-current-mode control is used to optimize system performance. Slope compensation is added to reduce current loop gain and improve power system stability. The FSBH-series has a built-in, synchronized, positive slope for each switching cycle.

Soft-Start

The FSBH-series has an internal soft-start circuit that reduces the SenseFET switching current during power system startup. The characteristic curve of soft-start time versus V_{LMT} level is shown in Figure 27. The V_{LMT} level rises in six steps. By doing so, the power system can smoothly build up the rated output voltage and effectively reduce voltage stress on the PWM switch and output diode.

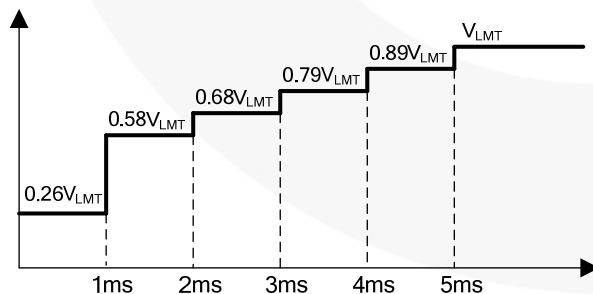

Figure 27. Soft-Start Function

Brown-In/Out Function

FSBH0x70 has a built-in internal brown-in/out protection comparator monitoring voltage of V_{IN} pin. Figure 28 shows a resistive divider with low-pass filtering for line-voltage detection on the V_{IN} pin.

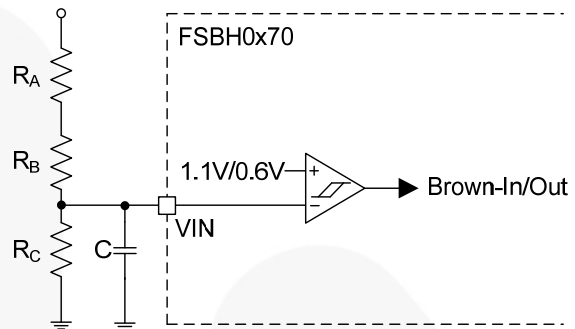

Figure 28. Brown-In/Out Function on V_{IN} Pin

Once the V_{IN} pin voltage is lower than 0.6V and lasts for 500ms, the PWM gate is disabled to protect the system from over current. FSBH0x70 starts up as V_{IN} increases above 1.1V. Because the divider resistors of the V_{IN} pin are connected behind the bridge, the ratio calculations for brownout in PFC and non-PFC system are different, as shown in Figure 29. The formulas are provided in the following equations:

Brownout with PFC:

$$\frac{R_C}{R_A + R_B + R_C} \cdot \sqrt{2} V_{AC_OUT} \cdot \frac{2}{\pi} = 0.6 \quad (1)$$

Brownout with non-PFC:

$$\frac{R_C}{R_A + R_B + R_C} \cdot \sqrt{2} V_{AC_OUT} = 0.6 \quad (2)$$

Brown-in level is determined by:

$$V_{AC_IN} = \frac{1.1}{\sqrt{2}} \cdot \frac{R_A + R_B + R_C}{R_C} \quad (3)$$

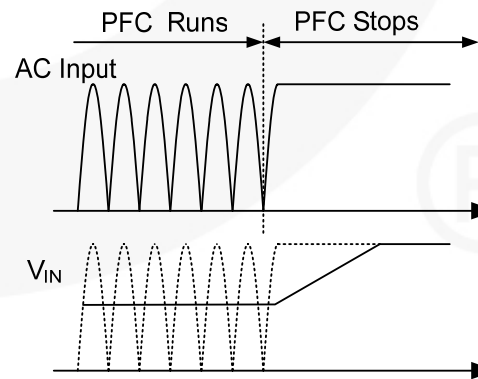

Figure 29. V_{IN} Level According to PFC Operation

Brown-In Function of FSBH0F70A

The VIN pin functions are disabled in FSBH0F70A, but FSBH0F70A has brown-in protection in the VDD pin. There is a discharge current internal from VDD to ground during startup. The HV source current must be larger than I_{DD-ST} to charge the capacitor of VDD. Therefore, the brown-in level can be determined by R_{HV} according to the equation:

$$R_{HV} = \frac{\sqrt{2}V_{AC} - 12}{I_{DD-ST}} \quad (4)$$

Green-Mode Operation

The FSBH-series uses feedback voltage (V_{FB}) as an indicator of the output load and modulates the PWM frequency, as shown in Figure 30, such that the switching frequency decreases as load decreases. In heavy-load conditions, the switching frequency is 100kHz. Once V_{FB} decreases below V_{FB-N} (2.5V), the PWM frequency starts to linearly decrease from 100kHz to 18kHz to reduce switching losses. As V_{FB} decreases below V_{FB-G} (2.0V), the switching frequency is fixed at 18kHz and the FSBH-series enters “deep” green mode to reduce the standby power consumption.

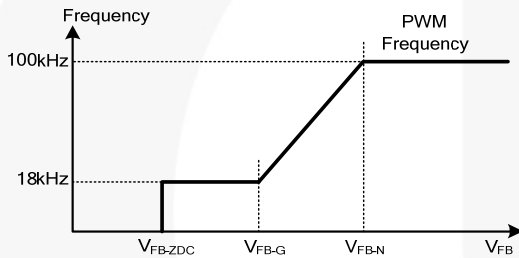

Figure 30. PWM Frequency

As V_{FB} decreases below V_{FB-ZDC} (1.6V), the FSBH-series enters burst-mode operation. When V_{FB} drops below V_{FB-ZDC}, FSBH-series stops switching and the output voltage starts to drop, which causes the feedback voltage to rise. Once V_{FB} rises above V_{FB-ZDC}, switching resumes. Burst mode alternately enables and disables switching, thereby reducing switching loss to improve power saving, as shown in Figure 31.

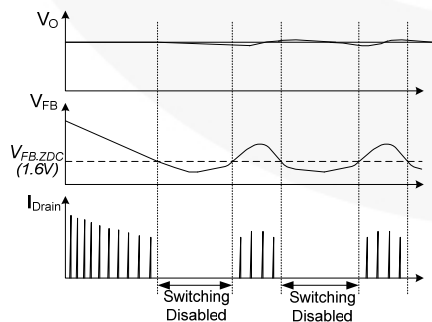

Figure 31. Burst-Mode Operation

H/L Line Over-Power Compensation

To limit the output power of the converter constantly, high/low line over-power compensation is included. Sensing the converter input voltage through the VIN pin, the high/low line compensation function generates a relative peak-current-limit threshold voltage for constant power control, as shown in Figure 32.

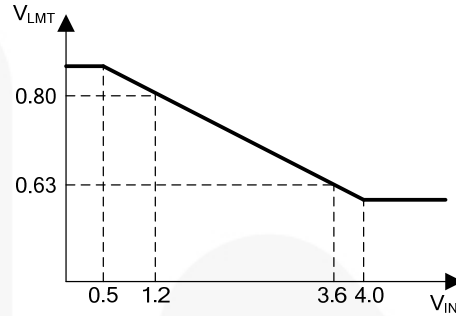

Figure 32. Constant Power Control

Protections

The FSBH-series provides full protection functions to prevent the power supply and the load from being damaged. The protection features include:

Latch/Auto-Recovery Function

Besides the brownout protection and high/low line over-power compensation, the FSBH0X70_F116 has additional protections via the VIN pin, such as pull-HIGH latch and pull-LOW auto-recovery that depends on the application. As shown in Figure 33, when V_{IN} level is higher than 4.7V, FSBH-series is latched until the V_{DD} is discharged. FSBH-series is auto-recovery when the V_{IN} level is lower than 0.3V.

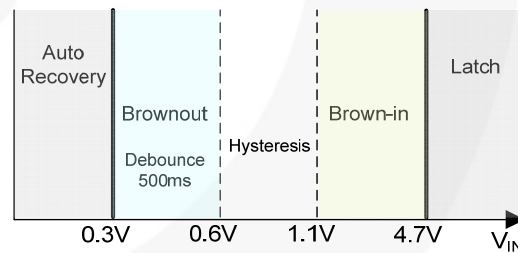
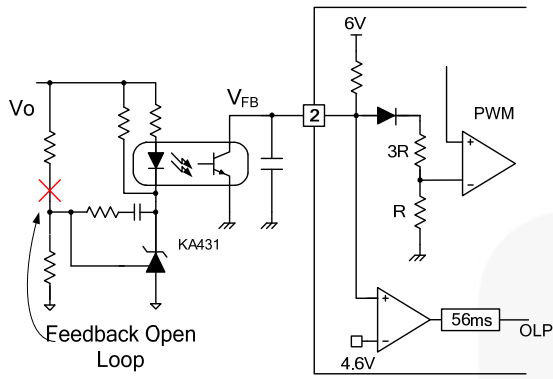

Figure 33. VIN Pin Function

Open-Loop / Overload Protection (OLP)

When the upper branch of the voltage divider for the shunt regulator (KA431 shown) is broken, as shown in Figure 34, or over current or output short occurs, there is no current flowing through the opto-coupler transistor, which pulls the feedback voltage up to 6V.

When feedback voltage is above 4.6V for longer than 56ms, OLP is triggered. This protection is also triggered when the SMPS output drops below the nominal value longer than 56ms due to the overload condition.



V_{DD} Over-voltage Protection (OVP)

V_{DD} over-voltage protection prevents IC damage caused by over voltage on the V_{DD} pin. The OVP is triggered when V_{DD} voltage reaches 28V. Debounce time (typically 130μs) prevents false trigger by switching noise.

Over-Temperature Protection (OTP)

The SenseFET and the control IC are integrated, making it easier to detect the temperature of the SenseFET. As the temperature exceeds approximately 142°C, thermal shutdown is activated.

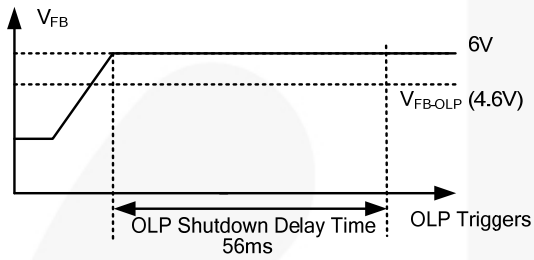
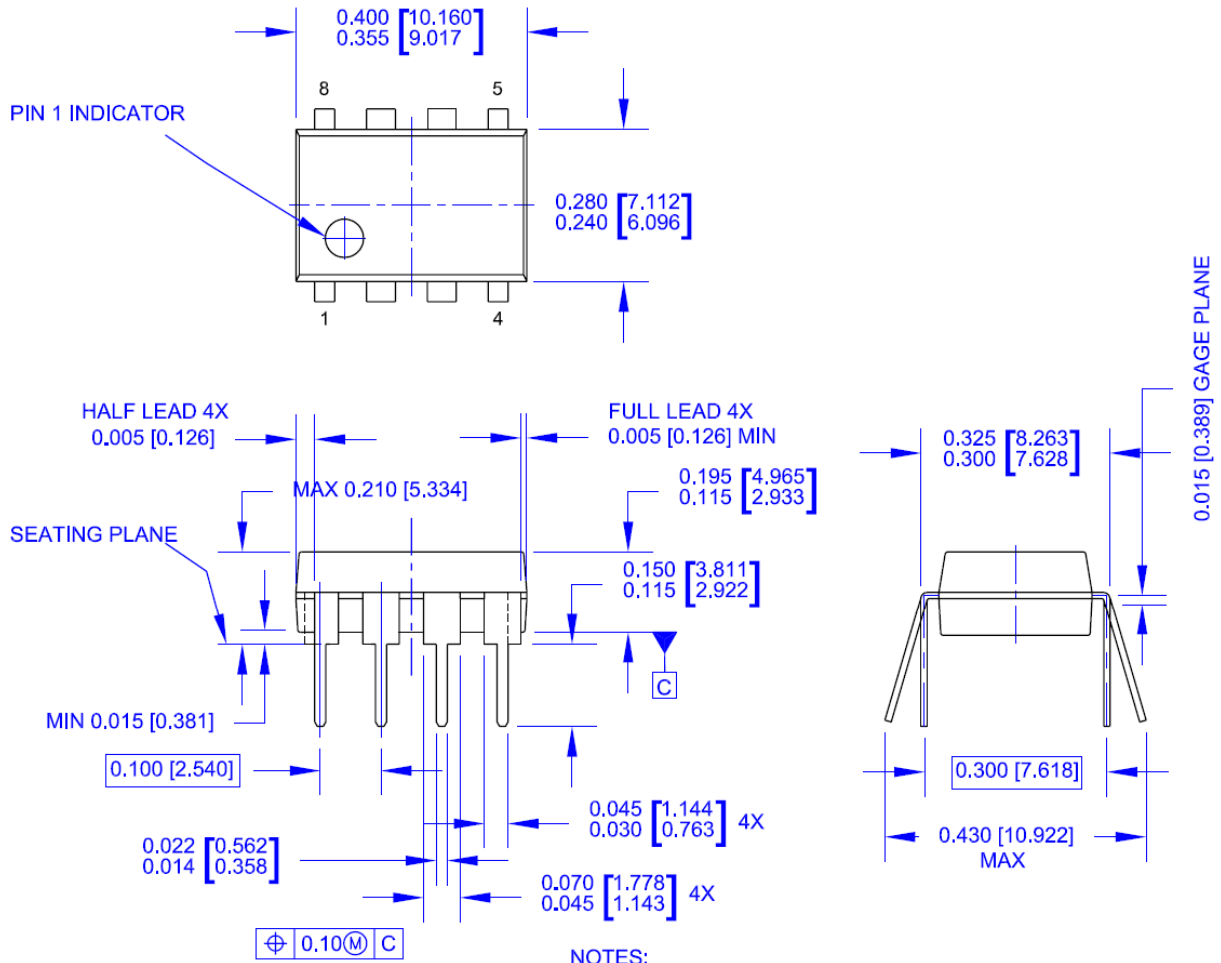

Figure 34. OLP Operation



Physical Dimensions



NOTES:

- A) THIS PACKAGE CONFORMS TO JEDEC MS-001 VARIATION BA
- B) CONTROLLING DIMS ARE IN INCHES
- C) DIMENSIONS ARE EXCLUSIVE OF BURRS, MOLD FLASH, AND TIE BAR EXTRUSIONS.
- D) DIMENSIONS AND TOLERANCES PER ASME Y14.5M-1982
- E) DRAWING FILENAME AND REVISION: MKT-N08MREV1.

Figure 35. 8-Pin Dual In-Line Package (DIP)





Package drawings are provided as a service to customers considering Fairchild components. Drawings may change in any manner without notice. Please note the revision and/or date on the drawing and contact a Fairchild Semiconductor representative to verify or obtain the most recent revision. Package specifications do not expand the terms of Fairchild's worldwide terms and conditions, specifically the warranty therein, which covers Fairchild products.

Always visit Fairchild Semiconductor's online packaging area for the most recent package drawings:
<http://www.fairchildsemi.com/packaging/>



TRADEMARKS

The following includes registered and unregistered trademarks and service marks, owned by Fairchild Semiconductor and/or its global subsidiaries, and is not intended to be an exhaustive list of all such trademarks.

- | | | | |
|--|--|---|---|
| AccuPower™ | F-PFST™ | Power-SPM™ | The Power Franchise® |
| Auto-SPM™ | FRFET® | PowerTrench® | The Right Technology for Your Success™ |
| AX-CAP™ | Global Power Resource™ | PowerXS™ | the power franchise |
| Build it Now™ | Green FPST™ | Programmable Active Droop™ | TinyBoost™ |
| CorePLUSTM | Green FPST™ e-Series™ | QFET® | TinyBuck™ |
| CorePOWER™ | Gmax™ | QST™ | TinyCalc™ |
| CROSSVOLT™ | GTO™ | Quiet Series™ | TinyLogic® |
| CTL™ | IntelliMAX™ | RapidConfigure™ | TINYOPTO™ |
| Current Transfer Logic™ | ISOPLANAR™ |  ™ | TinyPower™ |
| DEUXPEED® | MegaBuck™ | Saving our world, 1mVW/kW at a time™ | TinyPVM™ |
| Dual Cool™ | MICROCOUPLER™ | SignalWise™ | TinyWire™ |
| EcoSPARK® | MicroFET™ | SmartMax™ | TriFault Detect™ |
| EfficientMax™ | MicroPak™ | SMART START™ | TRUECURRENT®* |
| ESBC™ | MicroPak2™ | SPM® | µSerDes™ |
|  Fairchild® | MillerDrive™ | STEALTH™ |  SerDes™ |
| Fairchild Semiconductor® | MotionMax™ | SuperFET® | UHC™ |
| FACT Quiet Series™ | Motion-SPM™ | SuperSOT™-3 | Ultra FRFET™ |
| FACT® | mWSaver™ | SuperSOT™-6 | UniFET™ |
| FAST® | OptoHIT™ | SuperSOT™-8 | Vcx™ |
| FastvCore™ | OPTOLOGIC® | SupreMOS® | VisualMax™ |
| FETBench™ | OPTOPLANAR® | SyncFET™ | XST™ |
| FlashWriter® |  PDP SPM™ | Sync-Lock™ | |
| FPS™ | |  SYSTEM GENERAL® | |

* Trademarks of System General Corporation, used under license by Fairchild Semiconductor.

DISCLAIMER

FAIRCHILD SEMICONDUCTOR RESERVES THE RIGHT TO MAKE CHANGES WITHOUT FURTHER NOTICE TO ANY PRODUCTS HEREIN TO IMPROVE RELIABILITY, FUNCTION, OR DESIGN. FAIRCHILD DOES NOT ASSUME ANY LIABILITY ARISING OUT OF THE APPLICATION OR USE OF ANY PRODUCT OR CIRCUIT DESCRIBED HEREIN; NEITHER DOES IT CONVEY ANY LICENSE UNDER ITS PATENT RIGHTS, NOR THE RIGHTS OF OTHERS. THESE SPECIFICATIONS DO NOT EXPAND THE TERMS OF FAIRCHILD'S WORLDWIDE TERMS AND CONDITIONS, SPECIFICALLY THE WARRANTY THEREIN, WHICH COVERS THESE PRODUCTS.

LIFE SUPPORT POLICY

FAIRCHILD'S PRODUCTS ARE NOT AUTHORIZED FOR USE AS CRITICAL COMPONENTS IN LIFE SUPPORT DEVICES OR SYSTEMS WITHOUT THE EXPRESS WRITTEN APPROVAL OF FAIRCHILD SEMICONDUCTOR CORPORATION.

As used herein:

1. Life support devices or systems are devices or systems which, (a) are intended for surgical implant into the body or (b) support or sustain life, and (c) whose failure to perform when properly used in accordance with instructions for use provided in the labeling, can be reasonably expected to result in a significant injury of the user.
2. A critical component in any component of a life support, device, or system whose failure to perform can be reasonably expected to cause the failure of the life support device or system, or to affect its safety or effectiveness.

ANTI-COUNTERFEITING POLICY

Fairchild Semiconductor Corporation's Anti-Counterfeiting Policy. Fairchild's Anti-Counterfeiting Policy is also stated on our external website, www.fairchildsemi.com, under Sales Support.

Counterfeiting of semiconductor parts is a growing problem in the industry. All manufacturers of semiconductor products are experiencing counterfeiting of their parts. Customers who inadvertently purchase counterfeit parts experience many problems such as loss of brand reputation, substandard performance, failed applications, and increased cost of production and manufacturing delays. Fairchild is taking strong measures to protect ourselves and our customers from the proliferation of counterfeit parts. Fairchild strongly encourages customers to purchase Fairchild parts either directly from Fairchild or from Authorized Fairchild Distributors who are listed by country on our web page cited above. Products customers buy either from Fairchild directly or from Authorized Fairchild Distributors are genuine parts, have full traceability, meet Fairchild's quality standards for handling and storage and provide access to Fairchild's full range of up-to-date technical and product information. Fairchild and our Authorized Distributors will stand behind all warranties and will appropriately address any warranty issues that may arise. Fairchild will not provide any warranty coverage or other assistance for parts bought from Unauthorized Sources. Fairchild is committed to combat this global problem and encourage our customers to do their part in stopping this practice by buying direct or from authorized distributors.

PRODUCT STATUS DEFINITIONS

Definition of Terms

| Datasheet Identification | Product Status | Definition |
|--------------------------|-----------------------|---|
| Advance Information | Formative / In Design | Datasheet contains the design specifications for product development. Specifications may change in any manner without notice. |
| Preliminary | First Production | Datasheet contains preliminary data; supplementary data will be published at a later date. Fairchild Semiconductor reserves the right to make changes at any time without notice to improve design. |
| No Identification Needed | Full Production | Datasheet contains final specifications. Fairchild Semiconductor reserves the right to make changes at any time without notice to improve the design. |
| Obsolete | Not In Production | Datasheet contains specifications on a product that is discontinued by Fairchild Semiconductor. The datasheet is for reference information only. |

Rev. I53