

FAN1539/FAN1540

1A/1.3A, LDO with Low Quiescent Current

Features

- Very Low Ground Current ($I_{GND} = 1\text{mA}$)
- Excellent Line Regulation
- Excellent Load Regulation
- Very Low Transient Overshoot
- Stable with low ESR Output Capacitor ($ESR = 0\text{m}\Omega$)
- Thermal Shutdown
- Current Limit
- Output Options: 3.3V and 1.8V

Applications

- Disk Drive Circuits
- Desktop Computers
- Laptop, Notebook Computers
- General Purpose Three Terminal Regulator

Description

The FAN1539/FAN1540 series of high current LDOs (1.0A and 1.3A) has been developed for portable applications where low quiescent current is an important requirement. The device features excellent line and load transient response which does not exceed 10% of nominal output value for full operating temperature range even during power ON cycle and short circuit removal. Internally trimmed, temperature compensated bandgap reference guarantees 2.5% accuracy for full range of input voltage, output current and temperature. Included on the chip are accurate current limit and thermal shutdown protection. Device stability is achieved with only two external low ESR ceramic capacitors.

The FAN1539/FAN1540 is available in thermally enhanced 3x3mm 6-lead MLP, 5x6mm 8-lead MLP and 3-lead TO-252 packages. The 5x6mm MLP package version features a separate Kelvin sense pin for high precision applications.

Ordering Information

| Product Number | Output Voltage | Package |
|----------------|----------------|-------------------------|
| FAN1540MMPX | 3.3V | 5x6mm 8-Lead MLP in T&R |
| FAN1539MPX | 3.3V | 3x3mm 6-Lead MLP in T&R |
| FAN1540MPX | 3.3V | 3x3mm 6-Lead MLP in T&R |
| FAN1540DX | 3.3V | 3-Lead TO-252 in T&R |
| FAN1540D18X | 1.8V | 3-Lead TO-252 in T&R |

Tape and Reel Information

| Quantity | Reel Size | Width |
|----------|-----------|-------|
| 3000 | 7" | 8mm |

Block Diagram

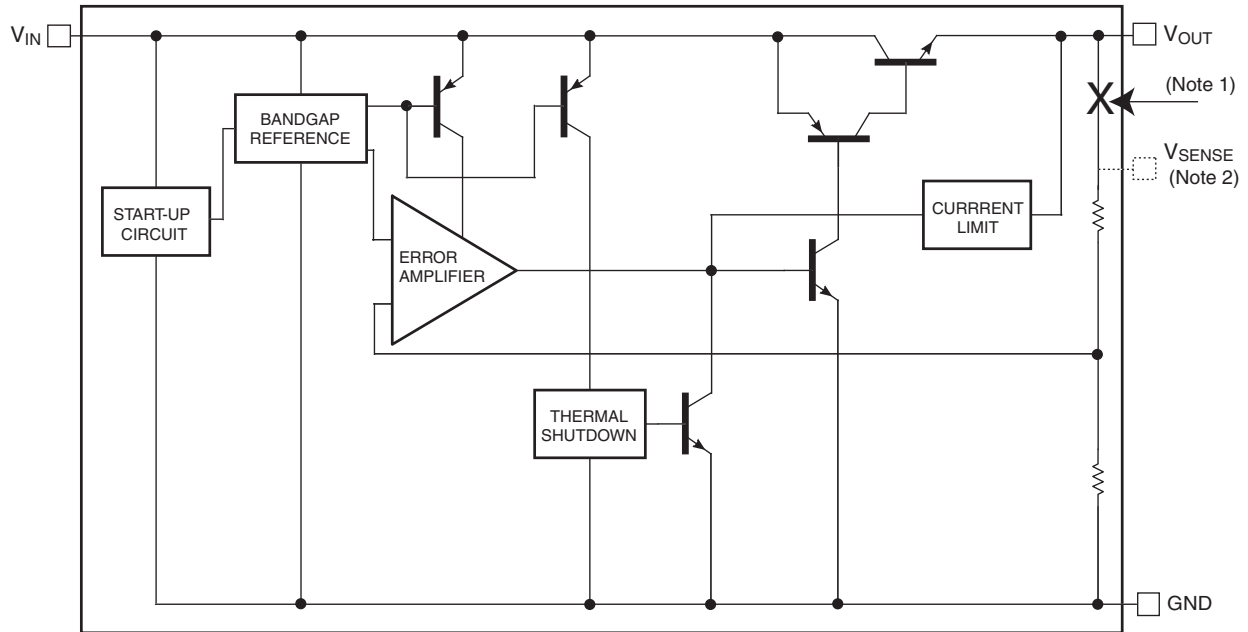

Notes:

1. No connection for FAN1540MMPX.
2. V_{SEN} available for FAN1540MMPX.

Pin Assignments

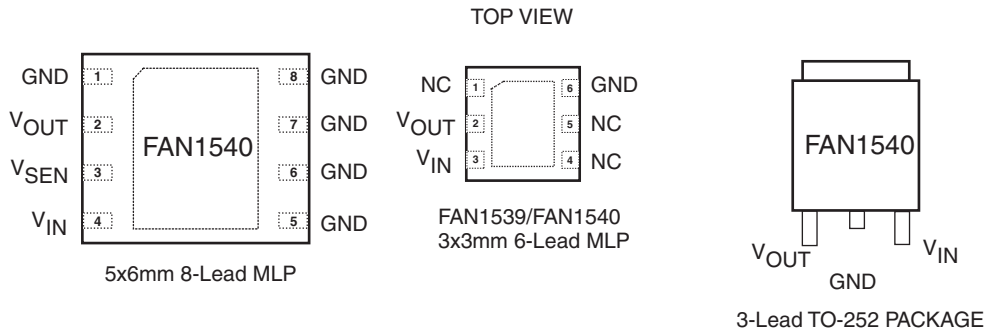

Pin Description

| Symbol | Name and Function |
|-----------|--|
| V_{IN} | Input pin |
| GND | Ground Pin (Tab) |
| V_{OUT} | Output pin: Fixed Output Voltage |
| V_{SEN} | Output sense pin. Connect to V_{OUT} if Kelvin sensing is not required |
| NC | No Connection |

Absolute Maximum Ratings

| Parameter | Symbol | Value | Units |
|---|---------------|--------------------|-------|
| Operating Input Voltage | V_{IN} | 10 | V |
| Power Dissipation | P_D | Internally Limited | W |
| Short Circuit Output Current | I_{OSH} | Internally Limited | A |
| Operating Junction Temperature Range | T_J | 0 to 150 | °C |
| Thermal Resistance–Junction to Tab, TO-252 | θ_{JC} | 3 | °C/W |
| Thermal Resistance–Junction to Tab, 3mmx3mm 6-lead MLP (Note 3) | θ_{JC} | 8 | °C/W |
| Thermal Resistance–Junction to Tab, 5mmx6mm 8-lead MLP (Note 3) | θ_{JC} | 4 | °C/W |
| Storage Temperature Range (Note 3) | T_{STG} | -65 to 150 | °C |
| Lead Temperature (I.R. Reflow) 30 Sec. (Note 4) | T_{LEAD} | 240 | °C |
| Lead Temperature (Soldering) 10 Sec. (Note 4) | T_{LEAD} | 260 | °C |
| Electrostatic Discharge Protection (Note 5) | HBM | ESD | 4 |
| | CDM | | 2 |

Notes:

- Junction to ambient thermal resistance, θ_{JA} , is a strong function of PCB material, board thickness, thickness and number of copper plains, number of via used, diameter of via used, available copper surface, and attached heat sink characteristics. Thermal resistance (θ_{JA}), V_{IN} , I_{OUT} must be chosen not to exceed $T_J = 150^\circ\text{C}$.
- Soldering temperature should be 260°C for 10 second after 240°C for 30 second in I.R. reflow using 60/40 solder. Maximum rate of temperature rise is $3^\circ\text{C}/\text{SEC}$ to within 100°C of the final temperature.
- Using Mil Std. 883E, method 3015.7(Human Body Model) and EIA/JESD22C101-A (Charge Device Model).

Electrical Characteristics—FAN1539MPX, FAN1540MPX, FAN1540MMPX, FAN1540DX

Unless otherwise specified, $V_{IN} = 4.50V$ to $7V$, $T_j = 25^\circ C$, I_{MAX} (FAN1539) = $1.0A$, I_{MAX} (FAN1540) = $1.3A$.

Boldface limits apply over operating junction temperature range of $0^\circ C \leq T_j \leq 125^\circ C$.

| Parameter | Symbol | Test Conditions | | Test Limits | | | Units |
|---|--|---|---|--------------|-------|---|-------------|
| | | V_{IN} | I_{OUT} | Min. | Typ. | Max. | |
| Output Voltage FAN1540 | V_{OUT} | $4.75V \leq V_{IN} \leq 5.25V$ | $5mA \leq I_{OUT} \leq I_{MAX}$ | 3.234 | 3.300 | 3.366 | V |
| | | | | 3.217 | | 3.383 | |
| Line Regulation | $REG_{(LINE)}$ | $3.0V \leq V_{IN} \leq 5.25V$ | $5mA \leq I_{OUT} \leq I_{MAX}$ | | 2 | 15 | mV |
| Load Regulation | $REG_{(LOAD)}$ | 4.75V | $5mA \leq I_{OUT} \leq I_{MAX}$ | FAN1539 | 25 | 35 | mV |
| | | | | FAN1540 | 30 | 40 | |
| Dropout Voltage (Note 6) | V_D | | $I_{OUT} = I_{MAX}$ | | 0.9 | 1.2 | V |
| Current Limit | I_S | 5.5V | | | 3.3 | | A |
| Min. Output Current for regulation ($\Delta V_{OUT} \leq 3\%$) | I_{OMIN} | | | | | 0 | mA |
| Temperature Stability | T_S | | $I_{OUT} = 5mA$ | | 0.3 | | % |
| RMS Output Noise (Note 7) | V_N | | $I_{OUT} = I_{MAX}$ | | 0.003 | | % V_{OUT} |
| Ripple Rejection Ratio (Note 8) | R_A | 5V | $I_{OUT} = 10mA$ | 65 | 75 | | dB |
| | | | $I_{OUT} = 100mA$ | 63 | 73 | | |
| | | | $I_{OUT} = I_{MAX}$ | 45 | 57 | | |
| Transient Response Change of V_{OUT} with step load change (Note 9) | $\frac{\Delta V_{OUT}}{\Delta I_{OUT}}$ | 5V | $1mA$ to I_{MAX} $t_f \geq 1\mu S$ | | 2.0 | 10 (under- shoot or overshoot of V_{OUT}) | % |
| | | | I_{MAX} to $1mA$ $t_f \geq 1\mu S$ | | | | |
| Transient Response Change of V_{OUT} with application of V_{IN} (Note 9) | $\frac{\Delta V_{OUT}}{\Delta V_{IN}}$ | 0 to 5V Step Input $t_f \geq 1\mu S$ 10% to 90% | $1mA \leq I_{OUT} \leq I_{MAX}$ | | 5.0 | 10 (under- shoot or overshoot of V_{OUT}) | % |
| Transient Response Short circuit Removal Response (Note 9) | $\frac{\Delta V_{OUT}}{\Delta V_{IN}}$ $@ I_{OUT} =$ short | 5V | $I_{OUT} =$ short to $I_{OUT} = 10mA$ | | 5.0 | 10 (over- shoot or under- shoot of V_O) | % |
| Quiescent Current | I_{GND} | $V_{IN} \leq 7V$ | $I_{OUT} = 0mA$ | | 1.0 | 2.0 | mA |

Electrical Characteristics—FAN1539MPX, FAN1540MPX, FAN1540MMPX, FAN1540DX (Continued)

Unless otherwise specified, $V_{IN} = 4.50V$ to $7V$, $T_j = 25^\circ C$, I_{MAX} (FAN1539) = $1.0A$, I_{MAX} (FAN1540) = $1.3A$. **Boldface limits** apply over operating junction temperature range of $0^\circ C \leq T_j \leq 125^\circ C$.

| Parameter | Symbol | Test Conditions | | Test Limits | | | Units |
|--------------------|------------|-------------------------------|---------------------------------|-------------|------|------------|------------|
| | | V_{IN} | I_{OUT} | Min. | Typ. | Max. | |
| Quiescent Current | I_{GND} | $V_{IN} \leq 7V$ | $2mA \leq I_{OUT} \leq I_{MAX}$ | | 1.0 | 2.0 | mA |
| Quiescent Current | I_{GND} | $V_{IN} = 5V$ | $0mA \leq I_{OUT} \leq 50mA$ | | 1.0 | 2.0 | mA |
| Thermal Shutdown | T_{jSD} | $3.0V \leq V_{IN} \leq 5.25V$ | | | 160 | | $^\circ C$ |
| Thermal Hysteresis | T_{HYST} | $3.0V \leq V_{IN} \leq 5.25V$ | | | 15 | | $^\circ C$ |

Notes:

6. Dropout voltage is defined as the input to output differential voltage at which the output voltage drops 1% below the nominal value measured at $V_{IN} = 5V$.
7. Measured within 10Hz to 10kHz bandwidth.
8. Measured at DC, specified at 120 Hz.
9. $C_{IN} = 22\mu F$, $C_{OUT} = 10\mu F$. Both capacitors are low ESR X7R type.

Test Circuit

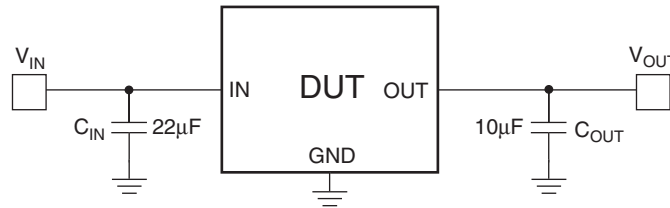

- Notes:
1. Use low ESR capacitors.
 2. C_{IN} should be placed as close to V_{IN} as possible.

Electrical Characteristics—FAN1540D18X

Unless otherwise specified, $V_{IN} = 3.135V$ to $3.465V$, $T_j = 25^\circ C$, $I_{MAX} = 1.3A$. **Boldface limits** apply over operating junction temperature range of $0^\circ C \leq T_j \leq 125^\circ C$.

| Parameter | Symbol | Test Conditions | | Test Limits | | | Units |
|---|--|---|--|--------------|--------------|--|-------------|
| | | V_{IN} | I_{OUT} | Min. | Typ. | Max. | |
| Output Voltage | V_{OUT} | $3.15V \leq V_{IN} \leq 3.465V$ | $5mA \leq I_{OUT} \leq I_{MAX}$ | 1.755 | 1.800 | 1.845 | V |
| Line Regulation | $REG_{(LINE)}$ | $3.135V \leq V_{IN} \leq 3.465V$ | $5mA \leq I_{OUT} \leq I_{MAX}$ | | 3 | 10 | mV |
| Load Regulation | $REG_{(LOAD)}$ | 3.3V | $5mA \leq I_{OUT} \leq I_{MAX}$ | | 20 | 40 | mV |
| Dropout Voltage (Note 6) | V_D | | $I_{OUT} = I_{MAX}$ | | 0.9 | 1.2 | V |
| Current Limit | I_S | 3.3V | | | 2.5 | | A |
| Min. Output Current for regulation ($\Delta V_{OUT} \leq 3\%$) | I_{OMIN} | | | | | 0 | mA |
| Temperature Stability | T_S | | $I_{OUT} = 5mA$ | | 0.3 | | % |
| RMS Output Noise (Note 7) | V_N | | $I_{OUT} = I_{MAX}$ | | 0.003 | | % V_{OUT} |
| Ripple Rejection Ratio (Note 8) | R_A | 3.3V | $I_{OUT} = 500mA$ | 40 | | | dB |
| Transient Response Change of V_{OUT} with step load change (Note 9) | $\frac{\Delta V_{OUT}}{\Delta I_{OUT}}$ | 3.3V | $1mA$ to I_{MAX} $t_r \geq 1\mu S$ I_{MAX} to $1mA$ $t_r \geq 1\mu S$ | | 2.0 | 10 (undershoot or overshoot of V_{OUT}) | % |
| Transient Response Change of V_{OUT} with application of V_{IN} (Note 9) | $\frac{\Delta V_{OUT}}{\Delta V_{IN}}$ | 0 to 1.8V Step Input $t_r \geq 1\mu S$ 10% to 90% | $1mA \leq I_{OUT} \leq I_{MAX}$ | | 3.0 | 10 (undershoot or overshoot of V_{OUT}) | % |
| Transient Response Short circuit Removal Response (Note 9) | $\frac{\Delta V_{OUT}}{\Delta V_{IN}}$ @ $I_{OUT} = \text{short}$ | 3.3V | $I_{OUT} = \text{short}$ to $I_{OUT} = 10mA$ | | 3.0 | 10 (overshoot or under-shoot of V_O) | % |
| Quiescent Current | I_{GND} | 3.3V | $I_{OUT} = 0mA$ | | 1.0 | 2.0 | mA |
| Quiescent Current | I_{GND} | 3.3V | $2mA \leq I_{OUT} \leq I_{MAX}$ | | 1.0 | 2.0 | mA |
| Thermal Shutdown | T_{JSD} | | | | 160 | | $^\circ C$ |
| Thermal Hysteresis | T_{HYST} | | | | 10 | | $^\circ C$ |

Notes:

- Dropout voltage is defined as the input to output differential voltage at which the output voltage drops 1% below the nominal value measured at $V_{IN} = 3.3V$.
- Measured within 10Hz to 10kHz bandwidth.
- Measured at DC, specified at 120 Hz.
- $C_{IN} = 22\mu F$, $C_{OUT} = 10\mu F$. Both capacitors are low ESR X7R type.

Test Circuit

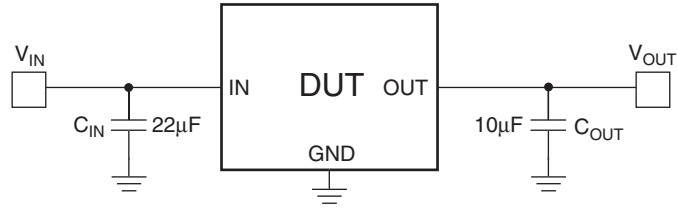

- Notes:
1. Use low ESR capacitors.
 2. C_{IN} should be placed as close to V_{IN} as possible.

Typical Performance Characteristics—FAN1539MPX, FAN1540MPX, FAN1540MMPX, FAN1540DX

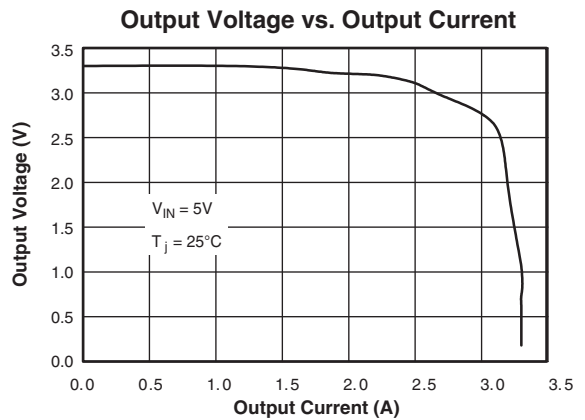
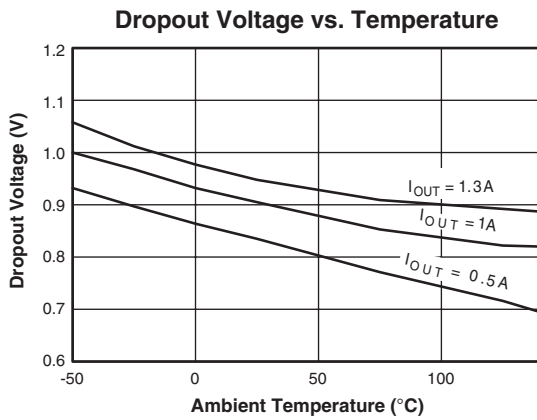
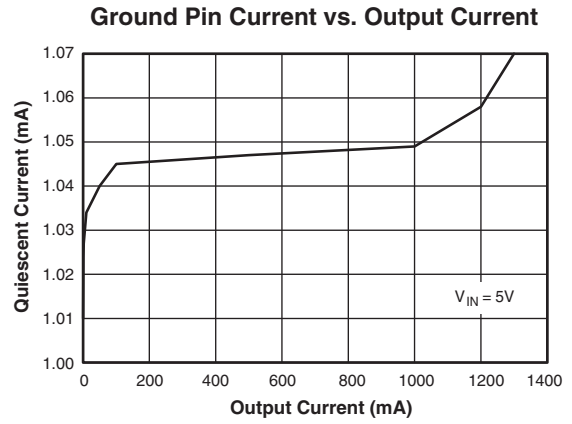
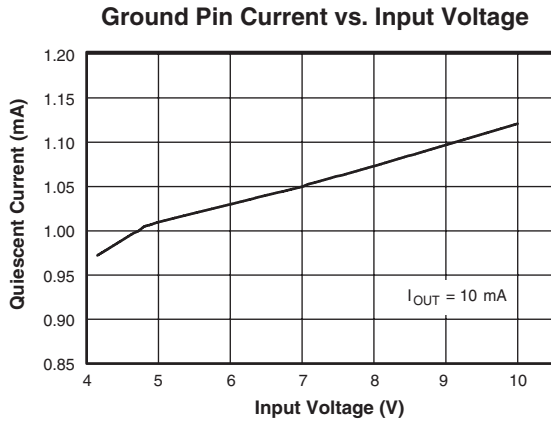
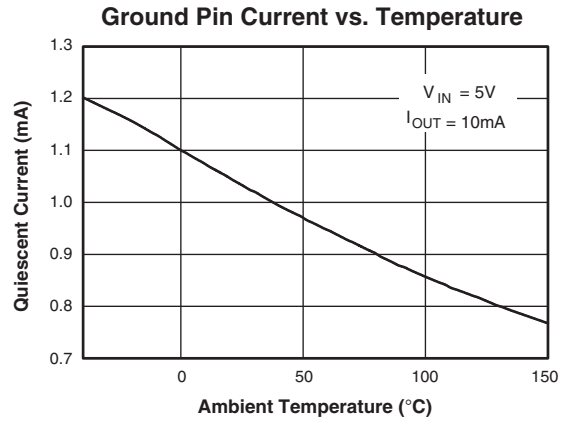
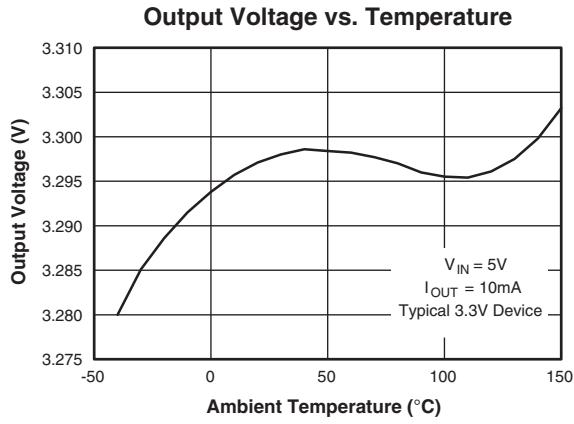

Typical Performance Characteristics—FAN1539MPX, FAN1540MPX, FAN1540MMPX, FAN1540DX (Continued)

Line Transient Response

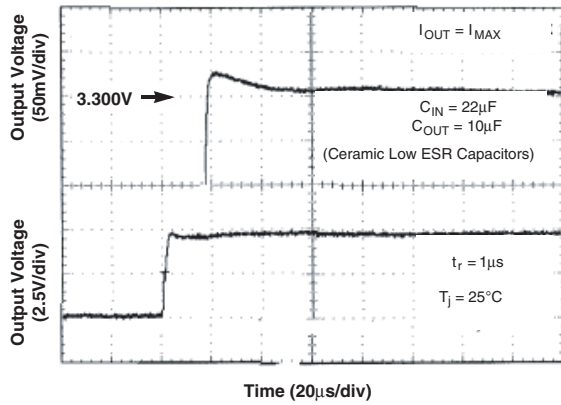

Load Transient Response

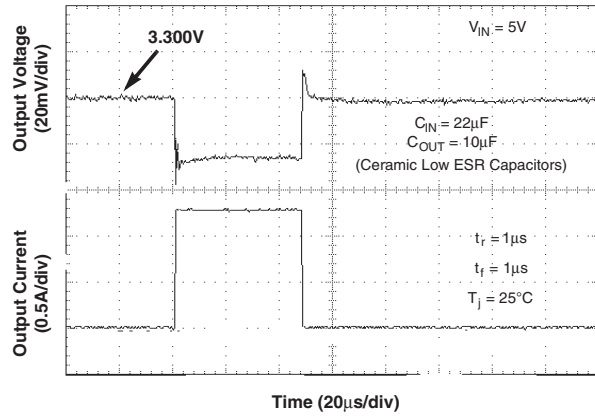

Short Circuit Removal Response

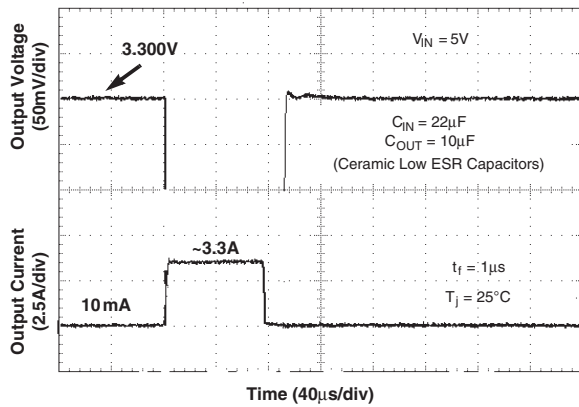

Ripple Rejection vs. Frequency

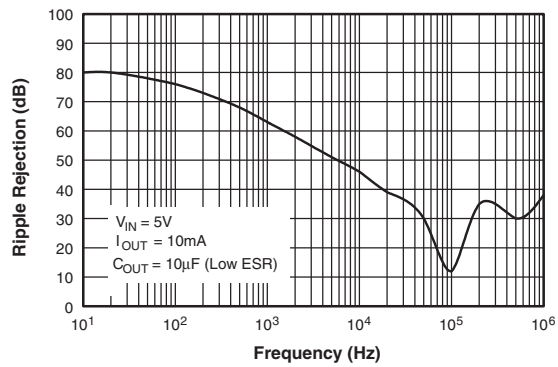

Output Spectral Noise Density vs. Frequency

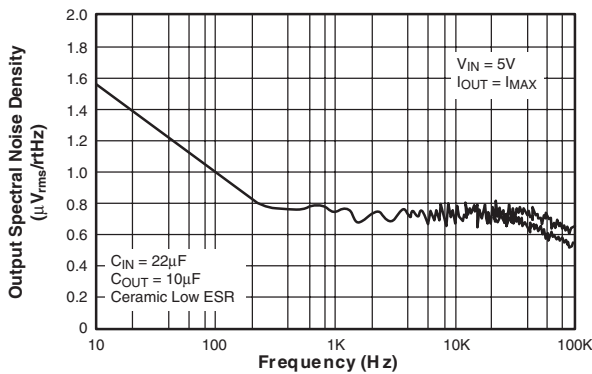

Typical Region of Stability ESR vs. Output Current*

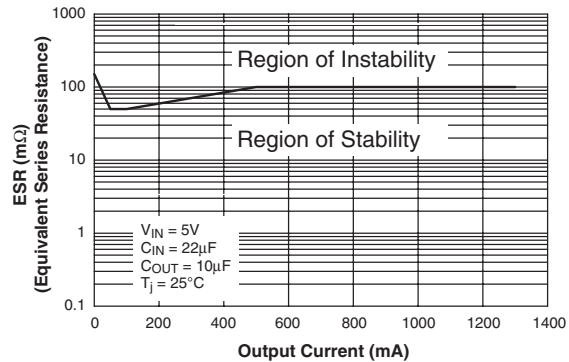

*Note: ESR Values measured at $f = 10kHz$

Note:

Transient response tests require short lead lengths and low resistance connections at source and load.

Typical Performance Characteristics—FAN1540D18X

Output Voltage vs. Temperature

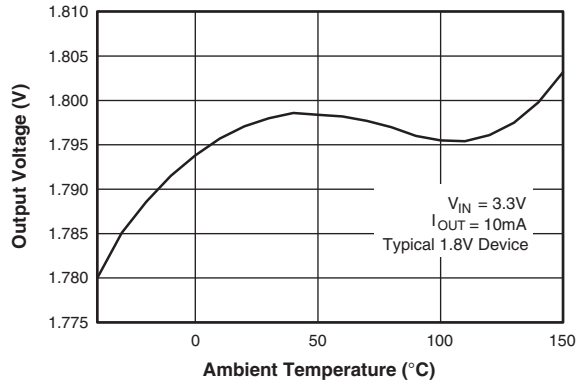

Ground Pin Current vs. Temperature

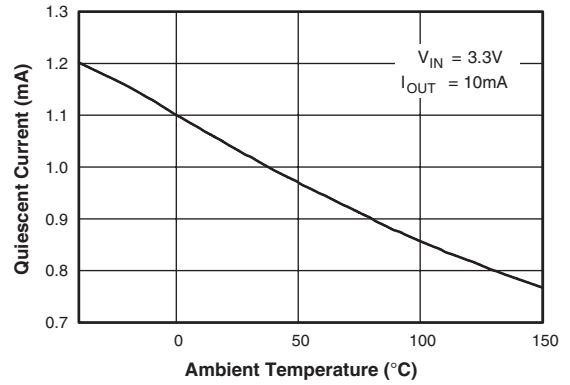

Ground Pin Current vs. Input Voltage

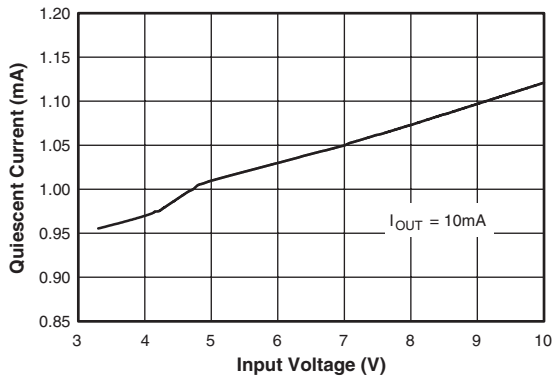

Ground Pin Current vs. Output Current

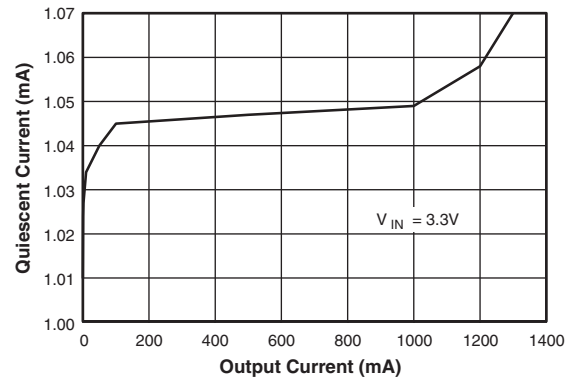

Dropout Voltage vs. Temperature

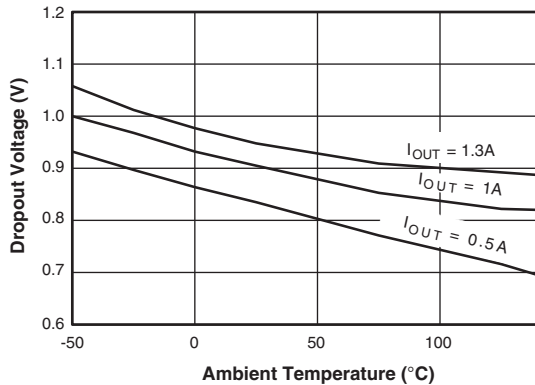

Output Voltage vs. Output Current

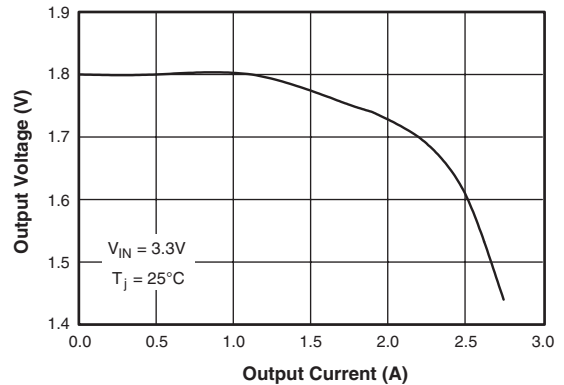

Applications Information

General Circuit Description

The FAN1539/FAN1540 is an advanced low dropout voltage regulator, specially designed for applications in portable computers, where high performance and low quiescent current are required. The device has an internal trimmed bandgap voltage reference and an internal output voltage sense divider. These two signals form the input to the error amplifier which regulates the output voltage.

The FAN1539/FAN1540 has a complete set of internal protection circuitry including thermal shutdown, short circuit current limit and electrostatic discharge protection. Low ESR ceramic capacitors are needed for input as well as output pins to maintain the circuit stability.

Short Circuit Current Limit

The device has internal over-current limit and short circuit protection. Under over-current conditions the device current is determined by the current limit threshold. Once the device is released from short circuit conditions, the normal level of current limit is gradually re-established as the device output voltage reaches normal levels. Special circuitry has been added to ensure that recovery from short circuit current conditions does not lead to excessive overshoot of the output voltage — a phenomenon often encountered in conventional regulators.

Thermal Protection

The FAN1539/FAN1540 is designed to supply at least 1A/1.3A output currents. Excessive output load at high input-output voltage difference will cause the device temperature to increase and exceed maximum ratings due to power dissipation. During output overload conditions, when the die temperature exceeds the shutdown limit temperature of 160°C, an onboard thermal protection will disable the output until the temperature drops approximately 15°C below the limit, at which point the output is re-enabled.

Thermal Characteristics

The FAN1539/FAN1540 is designed to supply at least 1A/1.3A at the specified output voltage with an operating die (junction) temperature of up to 125°C. Once the power dissipation and thermal resistance is known, the maximum junction temperature of the device can be calculated. While the power dissipation is calculated from known electrical parameters, the actual thermal resistance depends on the thermal characteristics of the chosen package and the surrounding PC board copper to which it is mounted.

The power dissipation is equal to the product of the input-to-output voltage differential and the output current plus the ground current multiplied by the input voltage, or:

$$P_D = (V_{IN} - V_{OUT})I_{OUT} + V_{IN}I_{GND}$$

The ground pin current, I_{GND} can be found in the charts provided in the “Electrical Characteristics” section.

The relationship describing the thermal behavior of the package is:

$$P_{D(max)} = \left\{ \frac{T_{J(max)} - T_A}{\theta_{JA}} \right\}$$

where $T_{J(max)}$ is the maximum allowable junction temperature of the die, which is 150°C, and T_A is the ambient operating temperature. θ_{JA} is dependent on the surrounding PC board layout and can be empirically obtained. While the θ_{JC} (junction-to-case) of the 6-lead MLP package is specified at 8°C/W, the θ_{JA} for a minimum PWB footprint will be in substantially higher. This can be improved upon by providing a heat sink of surrounding copper ground on the PWB. Depending on the size of the copper area, and the thickness of the copper layer, the resulting θ_{JA} can vary over a wide range. The addition of backside copper with through-holes, stiffeners, and other enhancements can also aid in reducing thermal resistance. ***Thermal simulations performed on a thermally optimized board layout indicate that θ_{JA} as low as 20°C/W can be achieved.*** For example, the heat contributed by the dissipation of other devices located nearby must be included in the design considerations.

Overload conditions also need to be considered. It is possible for the device to enter a thermal cycling loop, in which the circuit enters a shutdown condition, cools, re-enables, and then again overheats and shuts down repeatedly due to a persistent fault condition.

Capacitor ESR and Printed Circuit Board Layout

The FAN1539/FAN1540 has been optimized to accommodate low ESR bypass capacitors down to 0 mΩ. For best results it is important to place *both* input and output bypass capacitors as near to the input and output pins as possible. Use of X7R types such as Murata's GRM31CR70J106KA01B (10μF) and GRM43ER71A226KE01B (22μF) or similar component from TDK. The capacitors should connect directly to the ground plane. Use of ground plane on the top and the bottom side of the PCB is recommended. As many vias as possible should be used to minimize ground plane resistance.

Mechanical Dimensions

3-Lead TO-252

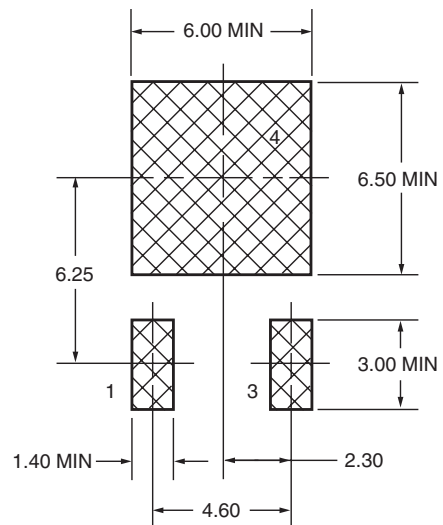
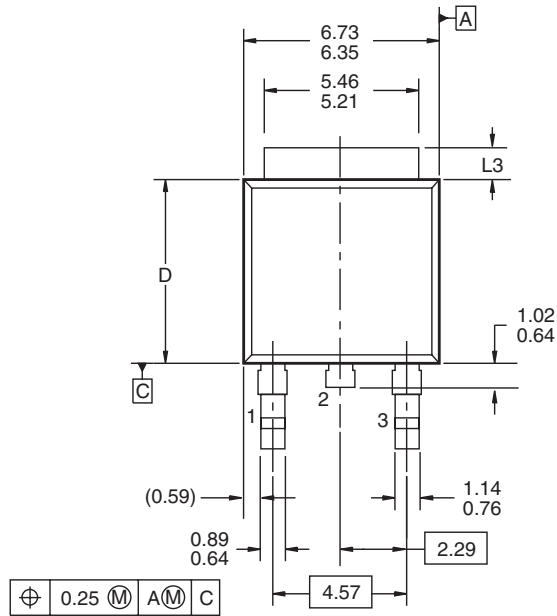

LAND PATTERN RECOMMENDATION

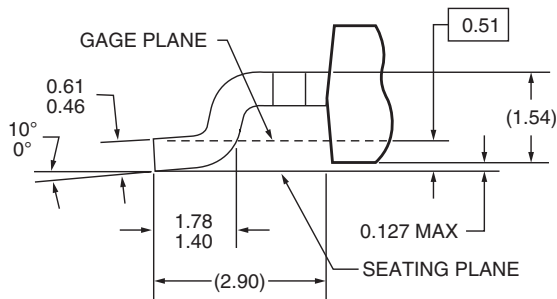
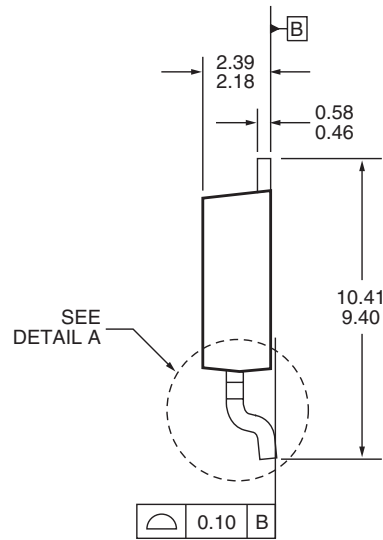
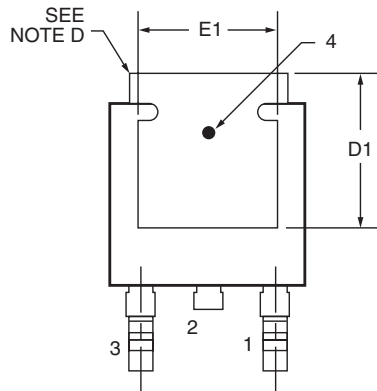

DETAIL A
(ROTATED -90°)
SCALE 12X

NOTES: UNLESS OTHERWISE SPECIFIED

- A) ALL DIMENSIONS ARE IN MILLIMETERS.
- B) THIS PACKAGE CONFORMS TO JEDEC, TO-252, ISSUE C. VARIATION AA & AB, DATED NOV. 1999.
- C) DIMENSIONING AND TOLERANCING PER ASME Y14.5-1994.
- D) HEAT SINK TOP EDGE COULD BE IN CHAMFERED CORNERS OR EDGE PROTRUSION.
- E) DIMENSIONS L3, D, E1 & D1 TABLE:

| | OPTION AA | OPTION AB |
|----|-------------|-------------|
| L3 | 0.89 – 1.27 | 1.52 – 2.03 |
| D | 5.97 – 6.22 | 5.33 – 5.59 |
| E1 | 4.32 MIN | 3.81 MIN |
| D1 | 5.21 MIN | 4.57 MIN |

TRADEMARKS

The following are registered and unregistered trademarks Fairchild Semiconductor owns or is authorized to use and is not intended to be an exhaustive list of all such trademarks.

| | | | | |
|--------------------------------------|---------------------|---------------|---------------------|-----------------|
| ACEx™ | FAST® | ISOPLANAR™ | PowerSaver™ | SuperSOT™-6 |
| ActiveArray™ | FASTr™ | LittleFET™ | PowerTrench® | SuperSOT™-8 |
| Bottomless™ | FPS™ | MICROCOUPLER™ | QFET® | SyncFET™ |
| Build it Now™ | FRFET™ | MicroFET™ | QS™ | TinyLogic® |
| CoolFET™ | GlobalOptoisolator™ | MicroPak™ | QT Optoelectronics™ | TINYOPTO™ |
| CROSSVOLT™ | GTO™ | MICROWIRE™ | Quiet Series™ | TruTranslation™ |
| DOME™ | HiSeC™ | MSX™ | RapidConfigure™ | UHC™ |
| EcoSPARK™ | I ² C™ | MSXPro™ | RapidConnect™ | UltraFET® |
| E ² CMOS™ | <i>i-Lo</i> ™ | OCX™ | μSerDes™ | UniFET™ |
| EnSigna™ | ImpliedDisconnect™ | OCXPro™ | ScalarPump™ | VCX™ |
| FACT™ | IntelliMAX™ | OPTOLOGIC® | SILENT SWITCHER® | Wire™ |
| FACT Quiet Series™ | | OPTOPLANAR™ | SMART START™ | |
| Across the board. Around the world.™ | | PACMAN™ | SPM™ | |
| The Power Franchise® | | POP™ | Stealth™ | |
| Programmable Active Droop™ | | Power247™ | SuperFET™ | |
| | | PowerEdge™ | SuperSOT™-3 | |

DISCLAIMER

FAIRCHILD SEMICONDUCTOR RESERVES THE RIGHT TO MAKE CHANGES WITHOUT FURTHER NOTICE TO ANY PRODUCTS HEREIN TO IMPROVE RELIABILITY, FUNCTION OR DESIGN. FAIRCHILD DOES NOT ASSUME ANY LIABILITY ARISING OUT OF THE APPLICATION OR USE OF ANY PRODUCT OR CIRCUIT DESCRIBED HEREIN; NEITHER DOES IT CONVEY ANY LICENSE UNDER ITS PATENT RIGHTS, NOR THE RIGHTS OF OTHERS.

LIFE SUPPORT POLICY

FAIRCHILD'S PRODUCTS ARE NOT AUTHORIZED FOR USE AS CRITICAL COMPONENTS IN LIFE SUPPORT DEVICES OR SYSTEMS WITHOUT THE EXPRESS WRITTEN APPROVAL OF FAIRCHILD SEMICONDUCTOR CORPORATION. As used herein:

1. Life support devices or systems are devices or systems which, (a) are intended for surgical implant into the body, or (b) support or sustain life, or (c) whose failure to perform when properly used in accordance with instructions for use provided in the labeling, can be reasonably expected to result in significant injury to the user.
2. A critical component is any component of a life support device or system whose failure to perform can be reasonably expected to cause the failure of the life support device or system, or to affect its safety or effectiveness.

PRODUCT STATUS DEFINITIONS

Definition of Terms

| Datasheet Identification | Product Status | Definition |
|--------------------------|------------------------|---|
| Advance Information | Formative or In Design | This datasheet contains the design specifications for product development. Specifications may change in any manner without notice. |
| Preliminary | First Production | This datasheet contains preliminary data, and supplementary data will be published at a later date. Fairchild Semiconductor reserves the right to make changes at any time without notice in order to improve design. |
| No Identification Needed | Full Production | This datasheet contains final specifications. Fairchild Semiconductor reserves the right to make changes at any time without notice in order to improve design. |
| Obsolete | Not In Production | This datasheet contains specifications on a product that has been discontinued by Fairchild semiconductor. The datasheet is printed for reference information only. |

Rev. 117