



Light-Curtain Device with 2-Wire Bus Interface

General Description

The epc10x chip set is a general purpose CMOS integrated circuit for light-curtain applications. epc100 is used on the receiver side (Rx) whereas epc 101 is on the emitter side (Tx). Up to 1023 devices may be connected to two respectively four wires in parallel. Each device can be individually addressed by an epc100 chip which acts as the interface between a microcontroller and the 2-wire bus. It manages the bus traffic between the microcontroller and the individual Rx and Tx elements. Programmable fuses i.e. for the address, sensitivity, LED light pulse width, etc. allow the device to be parametrized in the final system (OTP memory).

Each chip can be put into 'standby mode' or 'operating mode' to reduce power consumption. During 'standby mode', power consumption is reduced and the photo diode is shorted.

Refer to the separate Data Sheet of the epc101 transmitter chip and to the Reference Manual epc10x for implementation, usage and configuration information.

Feature

- Light pulse receiver
- Bus transceiver
- Advantageous wiring by communication over the power-supply lines
- High sensitive input for photo-diode current signals, typ. 60nA
- Scan period down to 30 μ s
- integrated clock generator
- CSP10 package with very small footprint and standard QFN16 package available

Applications

- Light barriers ranging from millimeters to tens of meters
- Light curtains
- Smoke detectors
- Liquid detectors

Functional Block Diagram

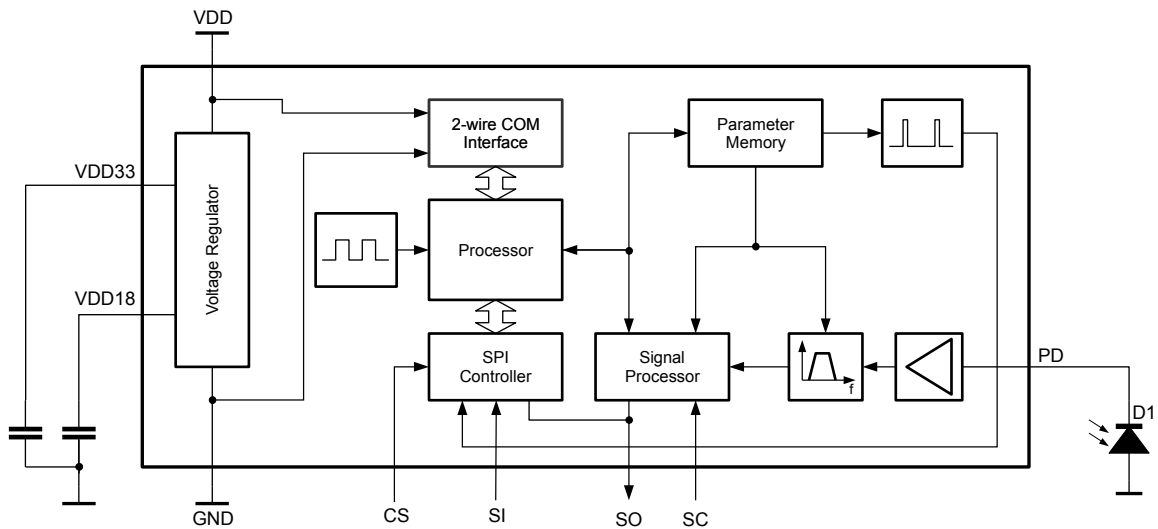

| Absolute Maximum Ratings (Notes 1, 2) | | Recommended Operating Conditions | | | |
|---|---------------------------------|---|-------------|--------------|----|
| Voltage to any pin except V _{DD} | -0.3V to V _{DD} +0.3 V | Min. | Max. | Units | |
| Supply Voltage on 2-wire bus V _{DD} | -0.3V to +8.0V | Operating Voltage on 2-wire bus V _{DD} | 4.5 | 5.5 | V |
| Programming Voltage on 2-wire bus V _{DD} | -0.3V to +8.0V | Programming Voltage on V _{DD} | 7.0 | 8.0 | V |
| Power Supply Voltage V _{DD33} | -0.3V to +5.5V | Operating Supply Voltage V _{DD33} | 3.0 | 3.6 | V |
| Input current at any pin except LED | -6mA to +6 mA | | | | |
| Power consumption with maximum load | 125mW | | | | |
| Storage Temperature Range (T _S) | -55°C to +155°C | Operating Temperature (T _O) | -40° | +85 | °C |
| Lead Temperature solder, 4 sec. (T _L) | +260°C | Relative Humidity (non-condensing) | +5 | +95 | % |

Note 1: Absolute Maximum Ratings indicate limits beyond which damage to the device may occur. Recommended operating conditions indicate conditions for which the device is intended to be functional, but do not guarantee specific performance limits. For guaranteed specifications and test conditions, see Electrical Characteristics.

Note 2: This device is a highly sensitive CMOS ac current amplifier with an ESD rating of JEDEC HBM class 0 (<250V). Handling and assembly of this device should only be done at ESD protected workstations.

Electrical Characteristics

V_{DD} = 5.0 V, -40°C < T_A < +85°C, if not otherwise specified

| Symbol | Parameter | Conditions/Comments | Values | | | Units | |
|----------------------|---|---|---------------------------------|------|------|-----------------------|-------------------|
| | | | Min. | Typ. | Max. | | |
| V _{PP} | Ripple on supply voltage, peak to peak | 2-wire interface V _{det} | | | | | |
| | | --- | Input pulse I _{PD,NST} | | | 70 | mV |
| | | 50mV | 36nA | | | 150 | mV |
| | | 100mV | 48nA | | | 350 | mV |
| | | 200mV | 72nA | | | 600 | mV |
| I _{DD,IDLE} | Current consumption | in idle mode | | | | 1.4 | mA |
| I _{DD,OP} | Current consumption | in operation mode I _{PD} = 0 mA | | | | 2.0 | mA |
| V _{det} | Detection level for 2-wire interface | | 50 | | | 200 | mV |
| I _{MOD} | Modulation current for 2-wire interface | | 6.4 | 8.0 | | 9.8 | mA |
| I _{PDDC} | DC Photo Diode Current | generated by ambient light | | | | 2 | mA |
| I _{PD,NST} | Input Pulse Threshold (Photo Current Sensitivity) | Photodiode current pulse to generate an output signal (only OUT=1), configurable (refer to the Reference Manual epc10x) | 24 | | | 108 | nA |
| I _{PD,RST} | Input Pulse Threshold (Photo Current Sensitivity) | Photodiode current pulse to generate an output signal (OUT=1 & OUTH=1) | | 90 | | | nA |
| I _{Pulse} | Maximum Input Pulse Current | If the input current is above this level, the T _{Relax} is undefined (refer to section 'Other Parameters') | | | | 100 | µA |
| T _{Pulse} | LED pulse length | | 1 | | | 10 | µs |
| T _{Relax} | Relaxation time | After a strong current pulse (I _{Pulse} = 100µA) | | | | 50 | µs |
| I _{N,Imin} | Input related noise | @ I _{PDDC} = 0 | | 7 | | 15 | nA _{RMS} |
| I _{N,Imax} | Input related noise | @ I _{PDDC} = I _{PDDC Max} | | | | 20 | nA _{RMS} |
| f _{clk} | Reference clock | Internal oscillator | | 32 | | | MHz |
| df _{clk} | Temperature drift of the oscillator | | | 7 | | | % |
| V _{PUP} | Power-up Threshold Voltage | The voltage at V _{DD33} when the device starts up | 2.4 | | | 3 | V |
| V _{IH} | High level input voltage | | 0.7 * V _{DD} | | | V _{DD} | V |
| V _{IL} | Low level input voltage | | GND | | | 0.3 * V _{DD} | V |
| I _{LEAKD} | Input leakage current | | | | | 10 | µA |
| V _{OH} | Output high voltage | @ 4mA sink except pin SCK/LED | V _{DD} - 0.5 | | | | V |
| V _{OL} | Output low voltage | @ 4mA source | | | | 0.5 | V |
| I _{SCK/LED} | Source current | @ PIN SCK / LED | 0.7 | | | 1.3 | mA |
| V _{Hist} | Schmitt Trigger Hysteresis | | 0.1 | | | | V |
| R _{PU} | Pull-Up Resistor | | 30 | | | 200 | kΩ |

Connection Diagrams

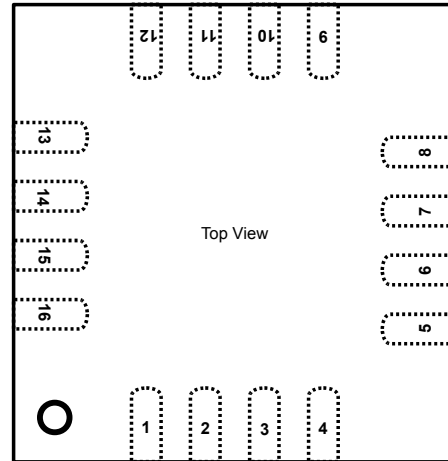
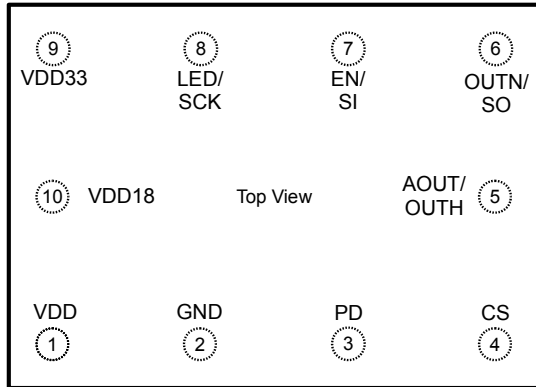

10-Pin Chip Scale Package (CSP)

16-Pin QFN Package

| 10-Pin CSP | 16-Pin QFN | PIN Name | Type | Description |
|------------|------------|-------------------|----------------------------|--|
| 1 | 9 | V _{DD} | Power supply | Positive power supply for regulator and positive terminal of the 2-wire interface. |
| 2 | 7 | GND | Power supply | Negative power supply pin. |
| 3 | 6 | PD | Analog Input | Photo diode input. |
| 4 | 4 | CS | Digital Input | SPI Interface: Chip Select. Active low, with pull up |
| 5 | 2 | AOUT OUTH | Analog Out Digital Out | Amplified and filtered signal of the photo diode (push-pull) or light reserve output (open drain) with 50 % threshold voltage above the threshold of the OUT output. |
| 6 | 1 | SO | Digital Output | SPI Interface: Serial out |
| 7 | 15 | SI | Digital Input | SPI Interface: Serial input |
| 8 | 14 | SCK | Digital Input | SPI Interface: Shift Clock |
| 9 | 12 | V _{DD33} | Power supply Decoupling | Positive power supply for analog and digital. If the the device is supplied by V _{DDR} , a power supply filter capacitor is connected to this pin. |
| 10 | 10 | V _{DD18} | Analog Out | 1.8 V regulator output. Do not use this pin, except for a decoupling capacitor. |
| n/a | 3 | NC | | Not connected. Connect this pin with VSS. |
| n/a | 5 | NC | | Not connected. Connect this pin with VSS. |
| n/a | 8 | NC | | Not connected. Connect this pin with VSS. |
| n/a | 11 | NC | | Not connected. Connect this pin with VSS. |
| n/a | 13 | NC | | Not connected. Connect this pin with VSS. |
| n/a | 16 | NC | | Not connected. Connect this pin with VSS. |

Other Parameters

(typical values, $T_{amb} = 25^{\circ}C$, $V_{DD} = 5.0V$)

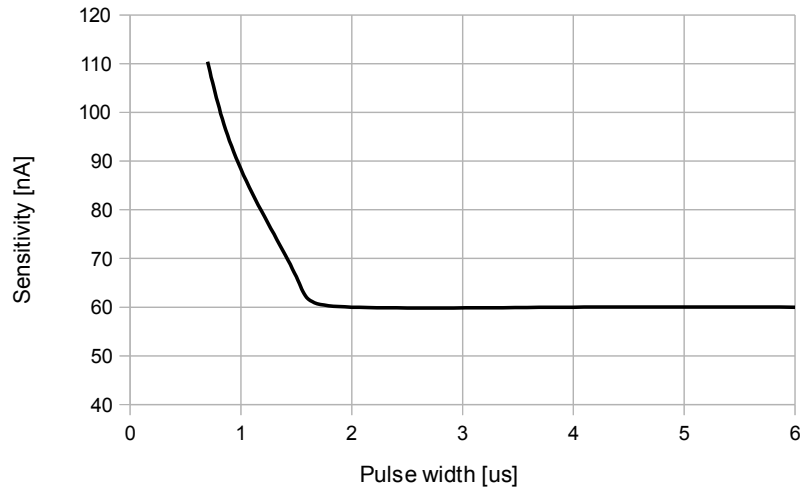

Figure 1: Input Sensitivity vs. LED pulse length

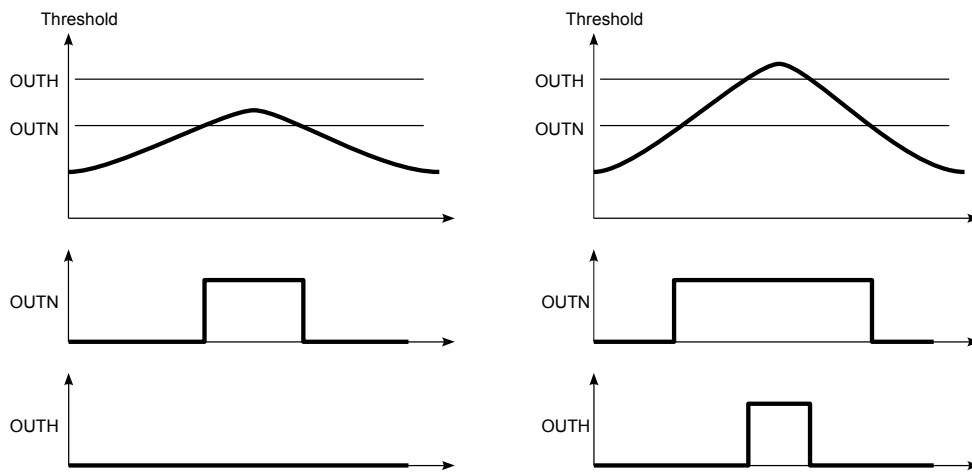

Figure 2: OUTH and OUTN threshold operation

Figure 3: Typical light curtain receiver edge circuit

Overview Functional Description

Light Curtain Receiver in a 2-Wire Configuration

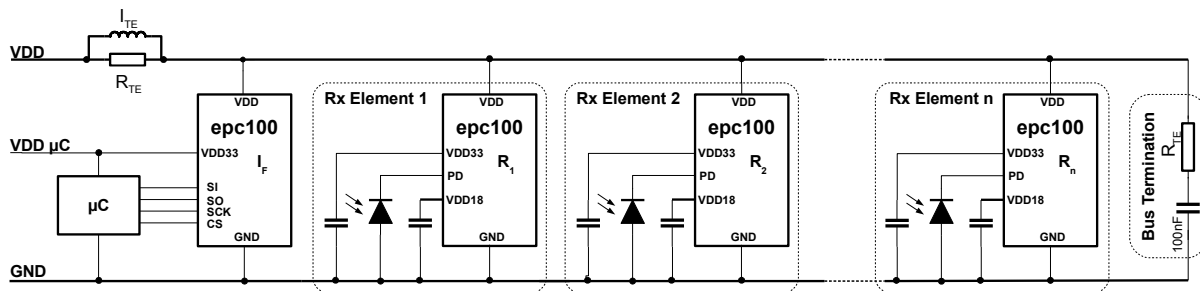

Figure 4: Typical light curtain receiver edge circuit

The epc100 device can be operated in two different modes:

a) Photo Current Receivers

It detects current pulses of the photo diode generated by light pulses and transmits the information using the 2-wire bus to a central controller, i.e. a micro controller. The devices operating as this photo current receivers are designated in the schematic diagram above as R_1 to R_n .

b) 2-Wire Bus Interface of the Central Controller

It manages the 2-wire bus traffic between the micro controller and the individual photo current receivers. The device operating as the interface unit is designated as I_F .

From the point of view of the micro controller, the whole system looks like a single device with several addressable photo diodes. The micro controller activates one photo diode and fetches the results after a predefined time. Each sensor device has two different operation modes: A standby and an operating mode. During the standby mode the power consumption is reduced and the DC current generated in the photo diode is shorted. During the operation mode, the micro controller addresses one device after the other and fetches the result. The result contains the information whether a light pulse has been received in a predefined receive window or not. It also contains the time point when the light pulse has been received in respect to the receive window.

The receiver channel detects current pulses which are generated by light pulses in the photo diodes. The detection circuitry has two trigger levels, hereinafter called thresholds, which form a digital signal from the analog current change. The lower threshold is called OUTH (normal) whereas the upper level is called OUTH (high). Both trigger thresholds can be configured individually per chip. Please refer to Figure 2 and to the Reference Manual epc10x which contains the configuration information.

Application Information

Schematic Circuit of one Node

Figure 5 shows the schematic circuit of one node on a light curtain system. A node consists of four components only: The receiver chip epc100, a photo diode and two supply voltage decoupling capacitors.

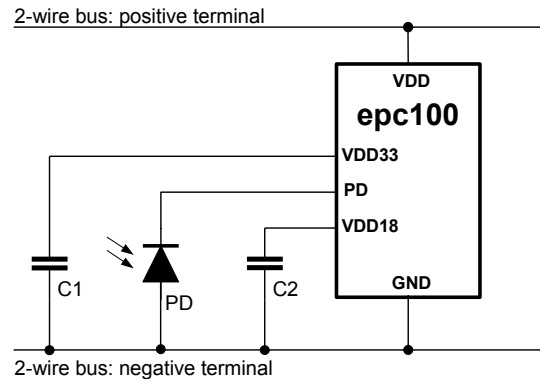

Figure 5: Schematic circuit of one node

Recommended Components Values

PD: PIN photo diode, i.e., epc300, epc310, epc320, epc330 (refer to the separate available data sheet epc3xx), or similar
 C1: 100nF ceramic capacitor
 C2: 4.7nF ceramic capacitor

Design Precautions

The sensitivity at pin PD is very high in order to achieve a long operation range of light curtains even without lenses in front of the IR LED and/or the photo diode. Thus, the pin PD is very sensitive to EMI. Special care should be taken to keep the PCB track at pin PD to the photo diode as short as possible (a few mm only!). This track should be kept away from sources emitting electromagnetic noise which may induce unwanted signals. It is strongly recommended to cover the chip and the photodiode with a metal shield. A recommended part is shown in Figure 6.

The pins at the bottom are to solder the shield to the PCB with electrical connection to GND. The hole in the front is the opening window for the photo diode. The back side of the PCB below the sensitive area (PD, epc100) shall be a polygon connected to GND to shield the circuit from the back side. The capacitors shall be of high mechanical stability (no piezoelectric effect) in order to avoid unwanted voltage modulation by mechanical shock or vibration.

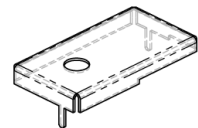



Figure 6: Recommended EMC shield

Ambient Light

Photodiode DC current is generated by ambient light, e.g. sun light. DC currents at pin PD do not generate an output signal. However, if I_{PDDC} is above the stated value, the input is saturated which blocks the detection of AC current pulses.

Photodiode Capacitance

If the photodiode capacitance is below the specified value, the system becomes more sensitive to power supply ripple voltage at higher frequencies (>200kHz). This sensitivity can be reduced by a parallel capacitor to the photodiode. However, this measure reduces the detection sensitivity. If the photo diode capacity is above the specified value, a lower detection sensitivity and a higher sensitivity spread results.

Layout Information (all measures in mm, )

CSP-10 Package

Mechanical Dimensions

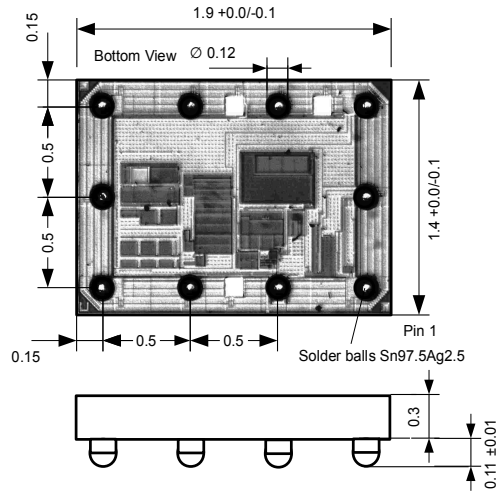

Layout Recommendations

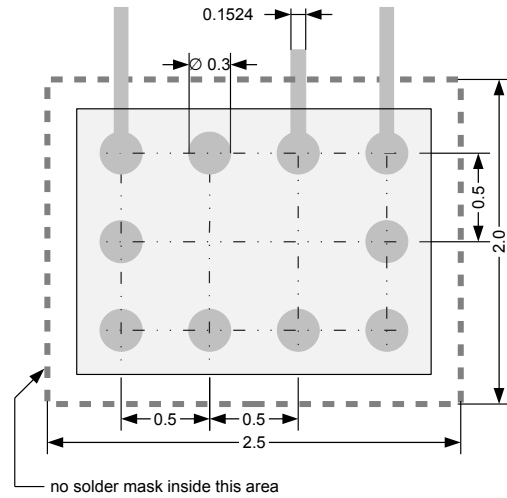

QFN-16 Package

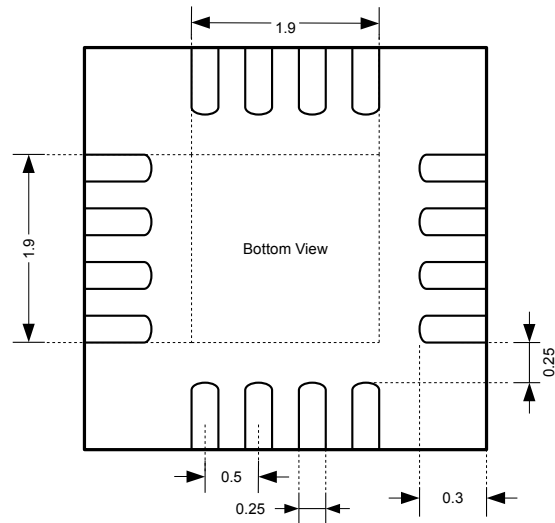
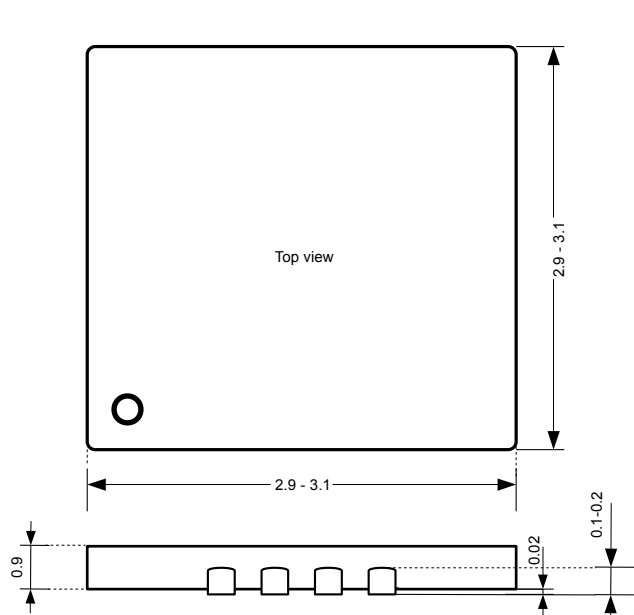

Reflow Solder Profile

For infrared or conventional soldering the solder profile has to follow the recommendations of IPC/JEDEC J-STD-020C (min. revision C) for Pb-free assembly for both types of packages. The peak soldering temperature (T_L) should not exceed +260°C for a maximum of 4 sec.

Packaging Information (all measures in mm)

Tape & Reel Information

The devices are mounted on embossed tape for automatic placement systems. The tape is wound on 178 mm (7 inch) or 330 mm (13 inch) reels and individually packaged for shipment. General tape-and-reel specification data are available in a separate data sheet and indicate the tape sizes for various package types. Further tape-and-reel specifications can be found in the Electronic Industries Association (EIA) standard 481-1, 481-2, 481-3.

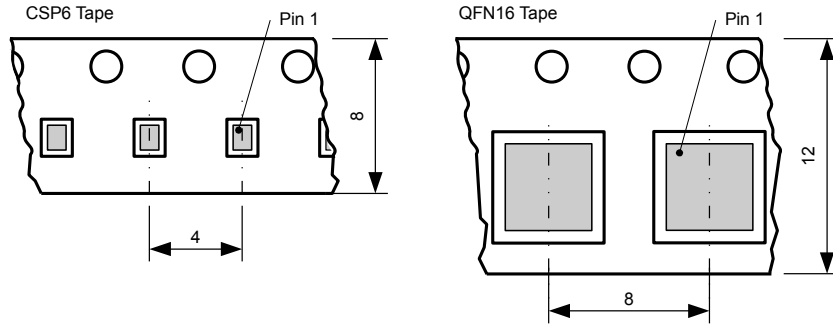

epc does not guarantee that there are no empty cavities. Thus, the pick-and-place machine should do check the presence of a chip during picking.

Ordering Information

| Part Number | Package | RoHS compliance | Packaging Method |
|--------------|---------|-----------------|------------------|
| epc100-CSP10 | CSP10 | Yes | Reel |
| epc100-QFN16 | QFN16 | Yes | Reel |
| epc101-CSP10 | CSP10 | Yes | Reel |
| epc101-QFN16 | QFN16 | Yes | Reel |

IMPORTANT NOTICE

ESPROS Photonics AG and its subsidiaries (epc) reserve the right to make corrections, modifications, enhancements, improvements, and other changes to its products and services at any time and to discontinue any product or service without notice. Customers should obtain the latest relevant information before placing orders and should verify that such information is current and complete. All products are sold subject to epc's terms and conditions of sale supplied at the time of order acknowledgment.

epc warrants performance of its hardware products to the specifications applicable at the time of sale in accordance with epc's standard warranty. Testing and other quality control techniques are used to the extent epc deems necessary to support this warranty. Except where mandated by government requirements, testing of all parameters of each product is not necessarily performed.

epc assumes no liability for applications assistance or customer product design. Customers are responsible for their products and applications using epc components. To minimize the risks associated with customer products and applications, customers should provide adequate design and operating safeguards.

epc does not warrant or represent that any license, either express or implied, is granted under any epc patent right, copyright, mask work right, or other epc intellectual property right relating to any combination, machine, or process in which epc products or services are used. Information published by epc regarding third-party products or services does not constitute a license from epc to use such products or services or a warranty or endorsement thereof. Use of such information may require a license from a third party under the patents or other intellectual property of the third party, or a license from epc under the patents or other intellectual property of epc.

Resale of epc products or services with statements different from or beyond the parameters stated by epc for that product or service voids all express and any implied warranties for the associated epc product or service. epc is not responsible or liable for any such statements.

epc products are not authorized for use in safety-critical applications (such as life support) where a failure of the epc product would reasonably be expected to cause severe personal injury or death, unless officers of the parties have executed an agreement specifically governing such use. Buyers represent that they have all necessary expertise in the safety and regulatory ramifications of their applications, and acknowledge and agree that they are solely responsible for all legal, regulatory and safety-related requirements concerning their products and any use of epc products in such safety-critical applications, notwithstanding any applications-related information or support that may be provided by epc. Further, Buyers must fully indemnify epc and its representatives against any damages arising out of the use of epc products in such safety-critical applications.

epc products are neither designed nor intended for use in military/aerospace applications or environments unless the epc products are specifically designated by epc as military-grade or "enhanced plastic." Only products designated by epc as military-grade meet military specifications. Buyers acknowledge and agree that any such use of epc products which epc has not designated as military-grade is solely at the Buyer's risk, and that they are solely responsible for compliance with all legal and regulatory requirements in connection with such use.

epc products are neither designed nor intended for use in automotive applications or environments unless the specific epc products are designated by epc as compliant with ISO/TS 16949 requirements. Buyers acknowledge and agree that, if they use any non-designated products in automotive applications, epc will not be responsible for any failure to meet such requirements.