

## 32,768-word × 8-bit High Speed CMOS Static RAM

The Hitachi HM62256A is a CMOS static RAM organized 32-kword × 8-bit. It realizes higher performance and low power consumption by employing 0.8 μm Hi-CMOS process technology. The device, packaged in a 8 × 14 mm TSOP with thickness of 1.2 mm, 450-mil SOP (foot print pitch width), 600-mil plastic DIP, or 300-mil plastic DIP, is available for high density mounting. TSOP package is suitable for cards, and reverse type TSOP is also provided. It offers low power standby power dissipation; therefore, it is suitable for battery back up system.

### Features

- High speed: Fast Access time 85/100/120/150 ns (max)
- Low Power  
Standby: 5 μW (typ) (L/L-SL version)  
Operation: 40 mW (typ) (f = 1 MHz)
- Single 5 V supply
- Completely static memory  
No clock or timing strobe required
- Equal access and cycle times
- Common data input and output: Three state output
- Directly TTL compatible: All inputs and outputs
- Capability of battery back up operation

### Ordering Information

Type No.	Access time	Package
HM62256AP-8	85 ns	600-mil
HM62256AP-10	100 ns	28-pin
HM62256AP-12	120 ns	plastic DIP
HM62256AP-15	150 ns	(DP-28)
HM62256ALP-8	85 ns	
HM62256ALP-10	100 ns	
HM62256ALP-12	120 ns	
HM62256ALP-15	150 ns	
HM62256ALP-8SL	85 ns	
HM62256ALP-10SL	100 ns	
HM62256ALP-12SL	120 ns	
HM62256ALP-15SL	150 ns	
HM62256ASP-8	85 ns	300-mil
HM62256ASP-10	100 ns	28-pin
HM62256ASP-12	120 ns	plastic DIP
HM62256ASP-15	150 ns	(DP-28NA)
HM62256ALSP-8	85 ns	
HM62256ALSP-10	100 ns	
HM62256ALSP-12	120 ns	
HM62256ALSP-15	150 ns	
HM62256ALSP-8SL	85 ns	
HM62256ALSP-10SL	100 ns	
HM62256ALSP-12SL	120 ns	
HM62256ALSP-15SL	150 ns	
HM62256AFP-8T	85 ns	450-mil
HM62256AFP-10T	100 ns	28-pin
HM62256AFP-12T	120 ns	plastic SOP
HM62256AFP-15T	150 ns	(FP-28DA)
HM62256ALFP-8T	85 ns	
HM62256ALFP-10T	100 ns	
HM62256ALFP-12T	120 ns	
HM62256ALFP-15T	150 ns	
HM62256ALFP-8SLT	85 ns	
HM62256ALFP-10SLT	100 ns	
HM62256ALFP-12SLT	120 ns	
HM62256ALFP-15SLT	150 ns	

Note: This device is not available for new application.

## TSOP Series

Type No.	Access time	Package	Type No.	Access time	Package
HM62256ALT-8	85 ns	8 mm × 14 mm	HM62256ALR-8	85 ns	8 mm × 14 mm
HM62256ALT-10	100 ns	32-pin TSOP	HM62256ALR-10	100 ns	32-pin TSOP
HM62256ALT-12	120 ns	(normal type)	HM62256ALR-12	120 ns	(reverse type)
HM62256ALT-15	150 ns	(TFP-32DA)	HM62256ALR-15	150 ns	(TFP-32DAR)
HM62256ALT-8SL	85 ns		HM62256ALR-8SL	85 ns	
HM62256ALT-10SL	100 ns		HM62256ALR-10SL	100 ns	
HM62256ALT-12SL	120 ns		HM62256ALR-12SL	120 ns	
HM62256ALT-15SL	150 ns		HM62256ALR-15SL	150 ns	

## Pin Arrangement

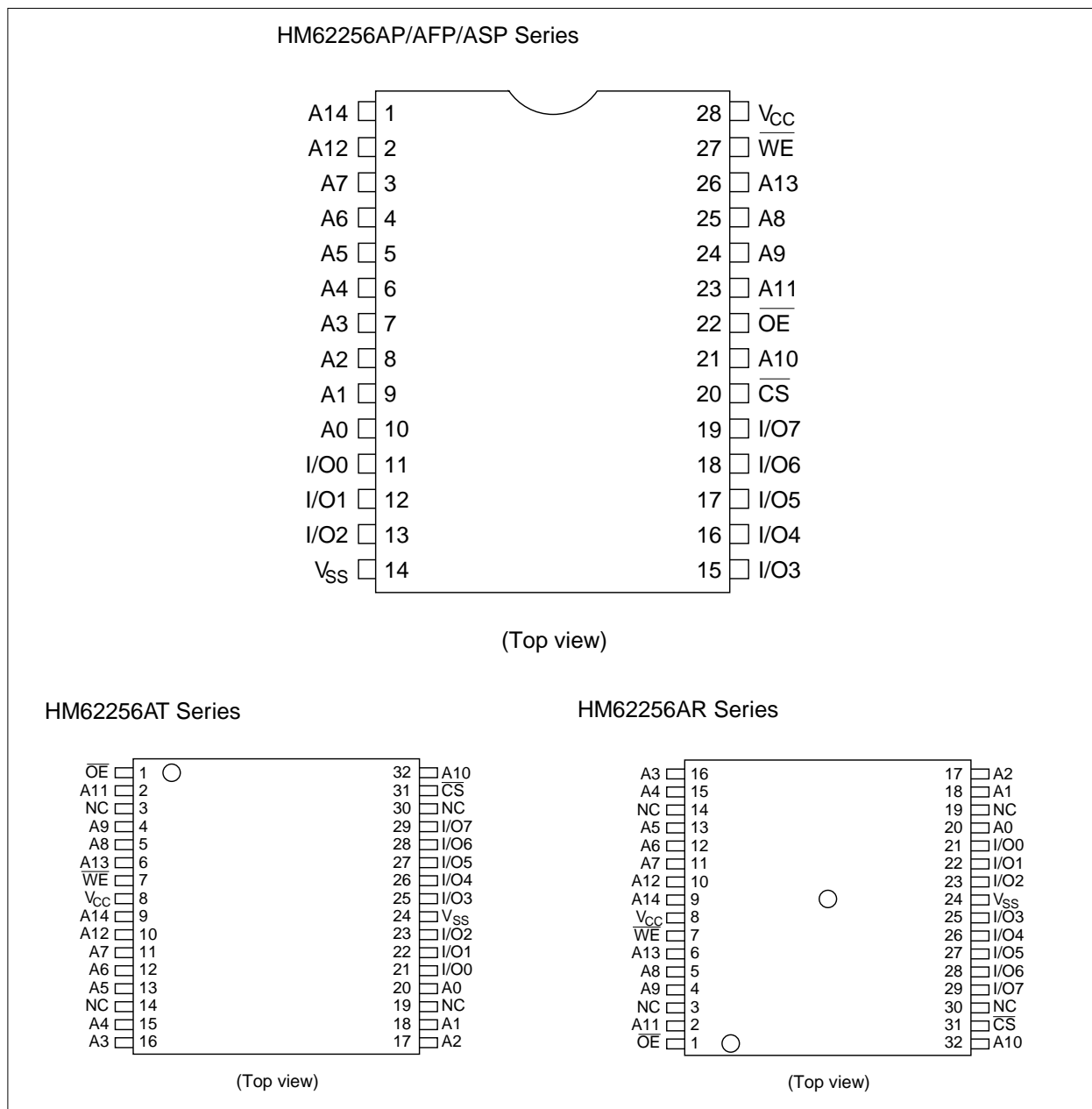

Pin Description

Symbol	Function	Symbol	Function
A0 – A14	Address	$\overline{OE}$	Output enable
I/O0 – I/O7	Input/output	NC	No connection
$\overline{CS}$	Chip select	$V_{CC}$	Power supply
$\overline{WE}$	Write enable	$V_{SS}$	Ground

Block Diagram

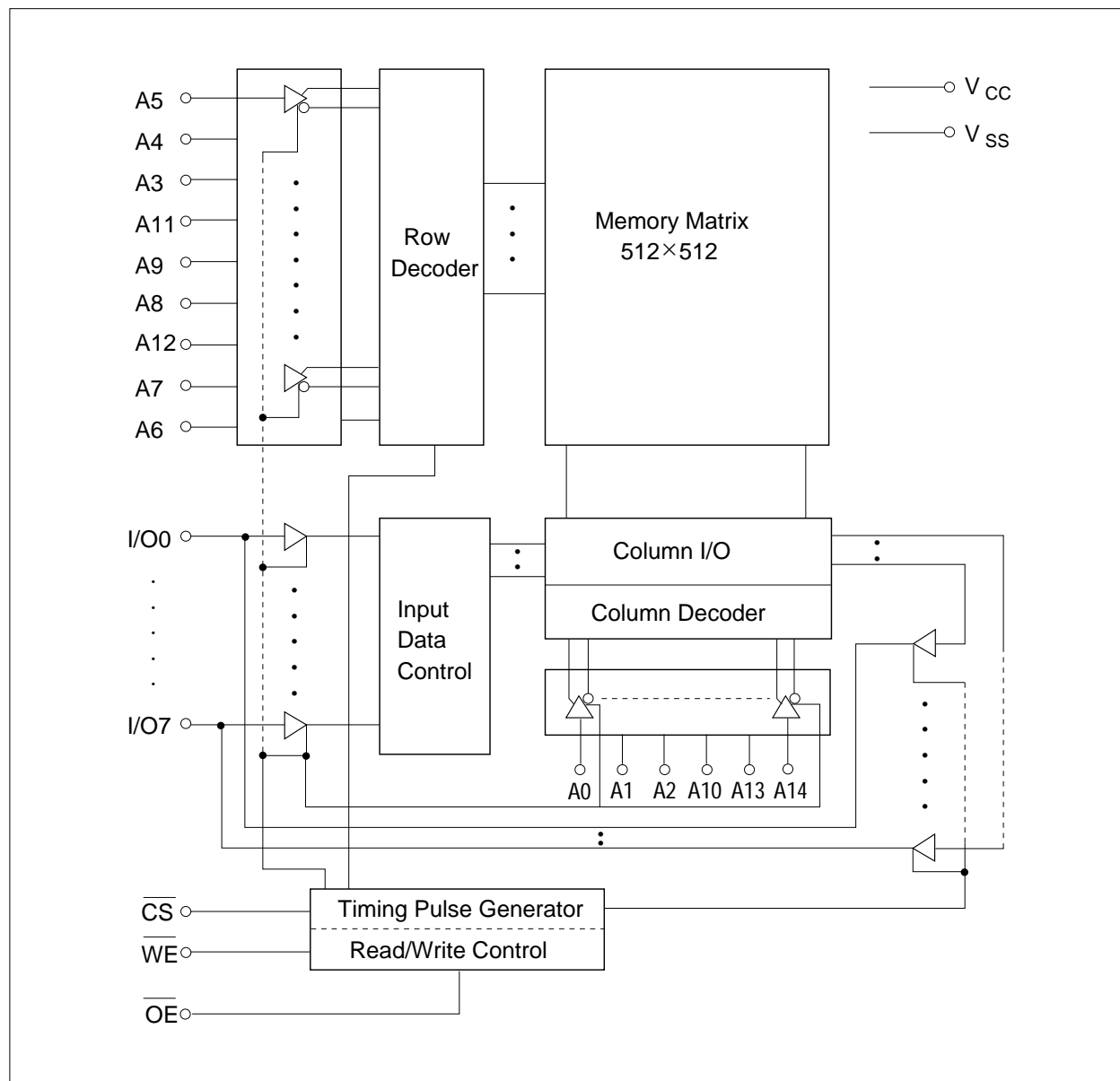

**Function Table**

$\overline{WE}$	$\overline{CS}$	$\overline{OE}$	Mode	$V_{CC}$ current	I/O pin	Ref. cycle
X	H	X	Not selected	$I_{SB}, I_{SB1}$	High-Z	—
H	L	H	Output disable	$I_{CC}$	High-Z	—
H	L	L	Read	$I_{CC}$	Dout	Read cycle (1)–(3)
L	L	H	Write	$I_{CC}$	Din	Write cycle (1)
L	L	L	Write	$I_{CC}$	Din	Write cycle (2)

Note: X: H or L

**Absolute Maximum Ratings**

Parameter	Symbol	Value	Unit
Voltage on any pin relative to $V_{SS}$	$V_T$	$-0.5^{*1}$ to +7.0	V
Power dissipation	$P_T$	1.0	W
Operating temperature	$T_{opr}$	0 to +70	°C
Storage temperature	$T_{stg}$	-55 to +125	°C
Storage temperature under bias	$T_{bias}$	-10 to +85	°C

Note: 1.  $V_T$  min = -3.0 V for pulse half-width  $\leq$  50 ns

**Recommended DC Operating Conditions ( $T_a = 0$  to +70°C)**

Parameter	Symbol	Min	Typ	Max	Unit
Supply voltage	$V_{CC}$	4.5	5.0	5.5	V
	$V_{SS}$	0	0	0	V
Input high (logic 1) voltage	$V_{IH}$	2.2	—	6.0	V
Input low (logic 0) voltage	$V_{IL}$	$-0.5^{*1}$	—	0.8	V

Note: 1.  $V_{IL}$  min = -3.0 V for pulse half-width  $\leq$  50 ns

**DC Characteristics** ( $T_a = 0$  to  $+70^\circ\text{C}$ ,  $V_{CC} = 5\text{ V} \pm 10\%$ ,  $V_{SS} = 0\text{ V}$ )

Parameter	Symbol	Min	Typ* <sup>1</sup>	Max	Unit	Test conditions
Input leakage current	$ I_{LI} $	—	—	1	$\mu\text{A}$	$V_{in} = V_{SS}$ to $V_{CC}$
Output leakage current	$ I_{LO} $	—	—	1	$\mu\text{A}$	$\overline{CS} = V_{IH}$ or $\overline{OE} = V_{IH}$ or $\overline{WE} = V_{IL}$ , $V_{I/O} = V_{SS}$ to $V_{CC}$
Operating $V_{CC}$ current	$I_{CC}$	—	6	15	mA	$\overline{CS} = V_{IL}$ , others = $V_{IH}/V_{IL}$ $I_{out} = 0\text{ mA}$
HM62256A-8	$I_{CC1}$	—	33	50	mA	min cycle, duty = 100%, $I_{I/O} = 0\text{ mA}$
HM62256A-10		—	30	50		$\overline{CS} = V_{IL}$ , others = $V_{IH}/V_{IL}$
HM62256A-12		—	27	45		
HM62256A-15		—	24	40		
	$I_{CC2}$	—	5	15	mA	Cycle time = $1\mu\text{s}$ , $I_{I/O} = 0\text{ mA}$ $\overline{CS} = V_{IL}$ , $V_{IH} = V_{CC}$ , $V_{IL} = 0$
Standby $V_{CC}$ current	$I_{SB}$	—	0.3	2	mA	$\overline{CS} = V_{IH}$
	$I_{SB1}$	—	0.01	1	mA	$V_{in} \geq 0\text{ V}$
		—	$0.3^{*2}$	$100^{*2}$	$\mu\text{A}$	$\overline{CS} \geq V_{CC} - 0.2\text{ V}$
		—	$0.3^{*3}$	$50^{*3}$	$\mu\text{A}$	
Output low voltage	$V_{OL}$	—	—	0.4	V	$I_{OL} = 2.1\text{ mA}$
Output high voltage	$V_{OH}$	2.4	—	—	V	$I_{OH} = -1.0\text{ mA}$

- Notes: 1. Typical values are at  $V_{CC} = 5.0\text{ V}$ ,  $T_a = +25^\circ\text{C}$  and not guaranteed.  
 2. This characteristics is guaranteed only for L-version.  
 3. This characteristics is guaranteed only for L-SL version.

**Capacitance** ( $T_a = 25^\circ\text{C}$ ,  $f = 1\text{ MHz}$ )\*<sup>1</sup>

Parameter	Symbol	Min	Typ	Max	Unit	Test conditions
Input capacitance	$C_{in}$	—	—	6	pF	$V_{in} = 0\text{ V}$
Input/output capacitance	$C_{I/O}$	—	—	8	pF	$V_{I/O} = 0\text{ V}$

- Note: 1. This parameter is sampled and not 100% tested.

**AC Characteristics** ( $T_a = 0$  to  $+70^\circ\text{C}$ ,  $V_{CC} = 5\text{ V} \pm 10\%$ , unless otherwise noted.)**Test Conditions**

- Input pulse levels: 0.8 V to 2.4 V
- Input and output timing reference levels: 1.5 V
- Input rise and fall times: 5 ns
- Output load: 1 TTL Gate +  $C_L$  (100 pF)  
(Including scope & jig)

**Read Cycle**

Parameter	Symbol	HM62256A-8		HM62256A-10		HM62256A-12		HM62256A-15		Unit	Note
		Min	Max	Min	Max	Min	Max	Min	Max		
Read cycle time	$t_{RC}$	85	—	100	—	120	—	150	—	ns	
Address access time	$t_{AA}$	—	85	—	100	—	120	—	150	ns	
Chip select access time	$t_{ACS}$	—	85	—	100	—	120	—	150	ns	
Output enable to output valid	$t_{OE}$	—	45	—	50	—	60	—	70	ns	
Chip selection to output in low-Z	$t_{CLZ}$	10	—	10	—	10	—	10	—	ns	2
Output enable to output in low-Z	$t_{OLZ}$	5	—	5	—	5	—	5	—	ns	2
Chip deselection to output in high-Z	$t_{CHZ}$	0	30	0	35	0	40	0	50	ns	1, 2
Output disable to output in high-Z	$t_{OHZ}$	0	30	0	35	0	40	0	50	ns	1, 2
Output hold from address change	$t_{OH}$	5	—	10	—	10	—	10	—	ns	

Read Timing Waveform (1) \*3

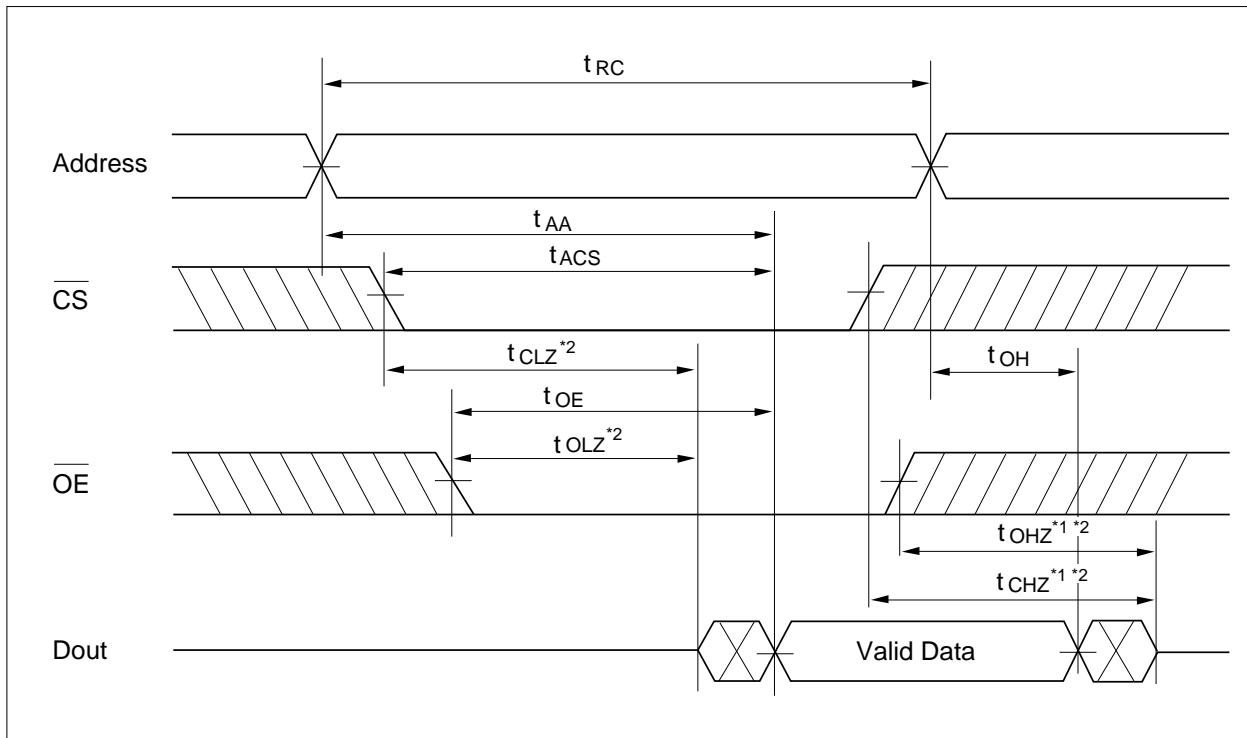

Read Timing Waveform (2) \*3 \*4 \*6

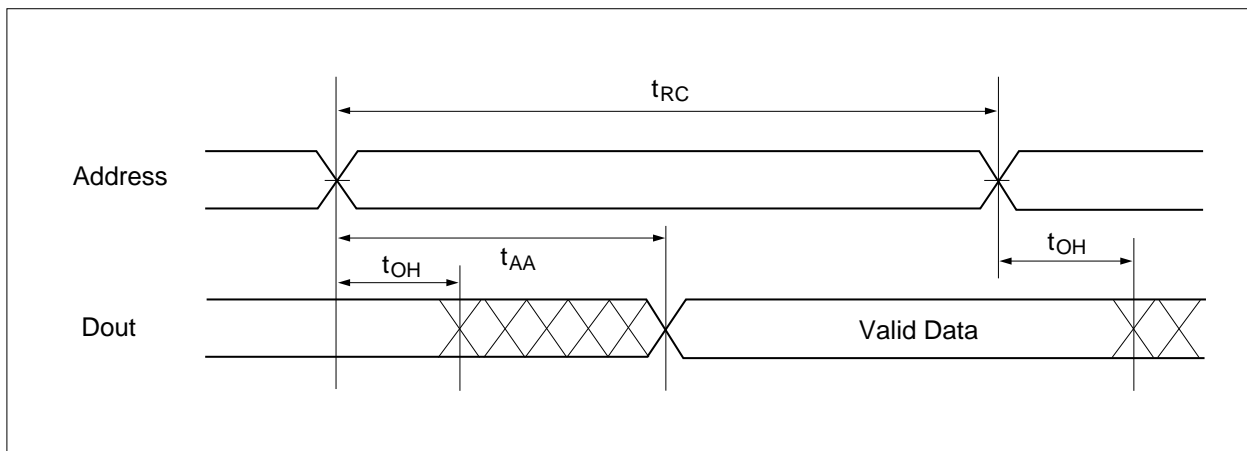

## Read Timing Waveform (3) \*3 \*5 \*6

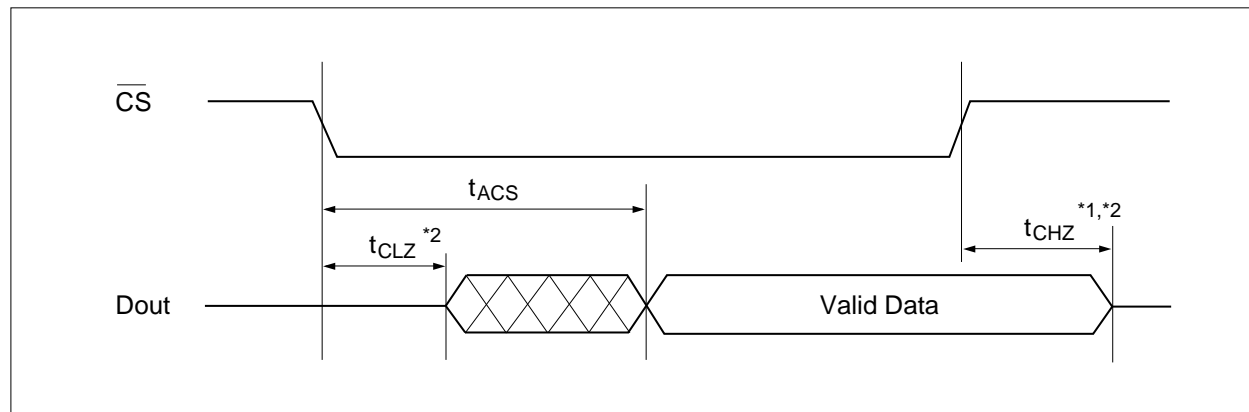

- Notes:
1.  $t_{CHZ}$  and  $t_{OHZ}$  are defined as the time at which the outputs achieve the open circuit conditions and are not referenced to output voltage levels.
  2. This parameter is sampled and not 100% tested.
  3.  $\overline{WE}$  is high for read cycle.
  4. Device is continuously selected,  $\overline{CS} = V_{IL}$ .
  5. Address Valid prior to or coincident with  $\overline{CS}$  transition Low.
  6.  $\overline{OE} = V_{IL}$ .

## Write Cycle

Parameter	Symbol	HM62256A-8		HM62256A-10		HM62256A-12		HM62256A-15		Unit	Note
		Min	Max	Min	Max	Min	Max	Min	Max		
Write cycle time	$t_{WC}$	85	—	100	—	120	—	150	—	ns	
Chip selection to end of write	$t_{CW}$	75	—	80	—	85	—	100	—	ns	2
Address setup time	$t_{AS}$	0	—	0	—	0	—	0	—	ns	3
Address valid to end of write	$t_{AW}$	75	—	80	—	85	—	100	—	ns	
Write pulse width	$t_{WP}$	55	—	60	—	70	—	90	—	ns	1
Write recovery time	$t_{WR}$	0	—	0	—	0	—	0	—	ns	4
$\overline{WE}$ to output in high-Z	$t_{WHZ}$	0	30	0	35	0	40	0	50	ns	10
Data to write time overlap	$t_{DW}$	40	—	40	—	50	—	60	—	ns	
Data hold from write time	$t_{DH}$	0	—	0	—	0	—	0	—	ns	
Output active from end of write	$t_{OW}$	5	—	5	—	5	—	5	—	ns	10
Output disable to output in high-Z	$t_{OHZ}$	0	30	0	35	0	40	0	50	ns	10, 11



Write Timing Waveform (1) ( $\overline{\text{OE}}$  Clock)

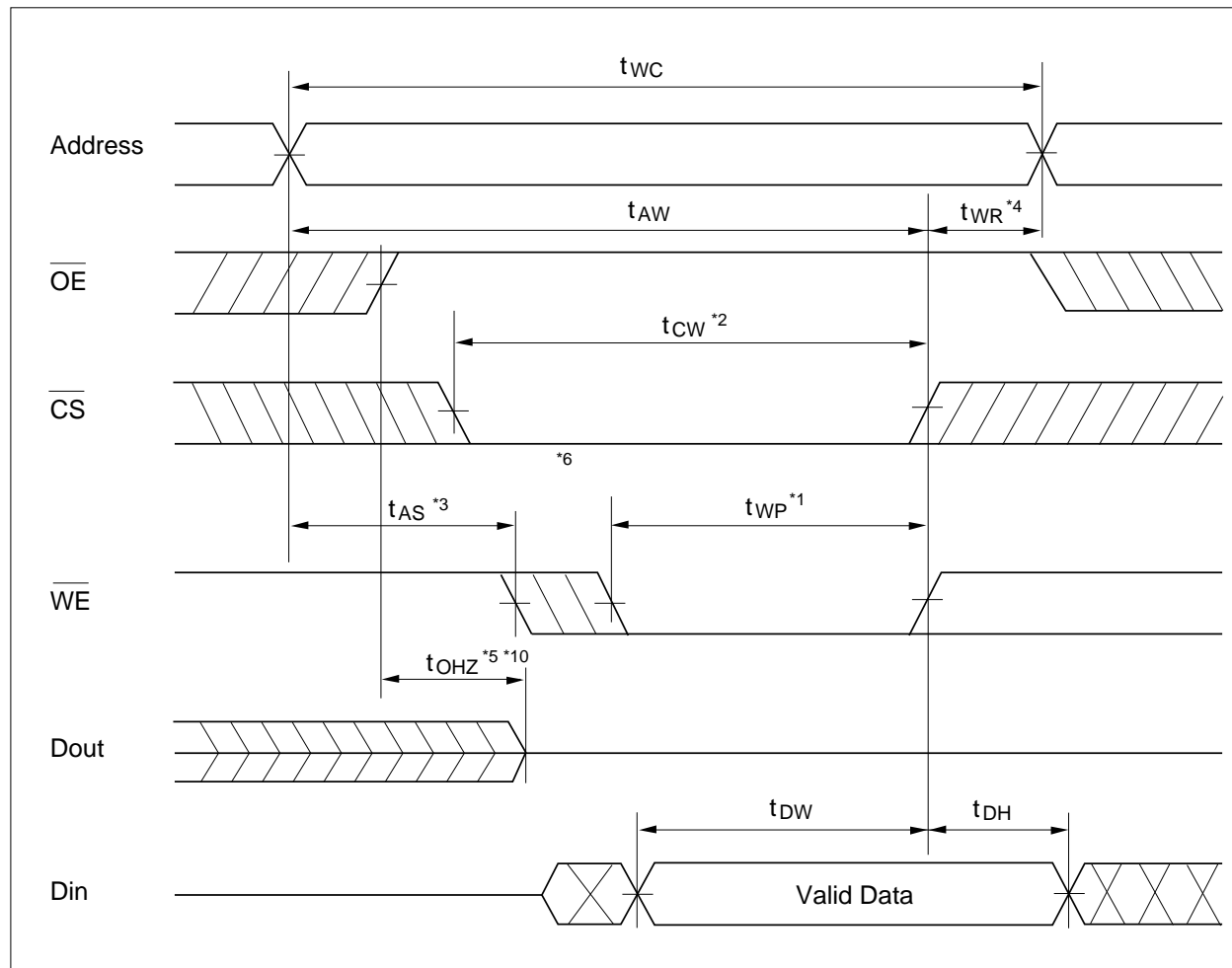

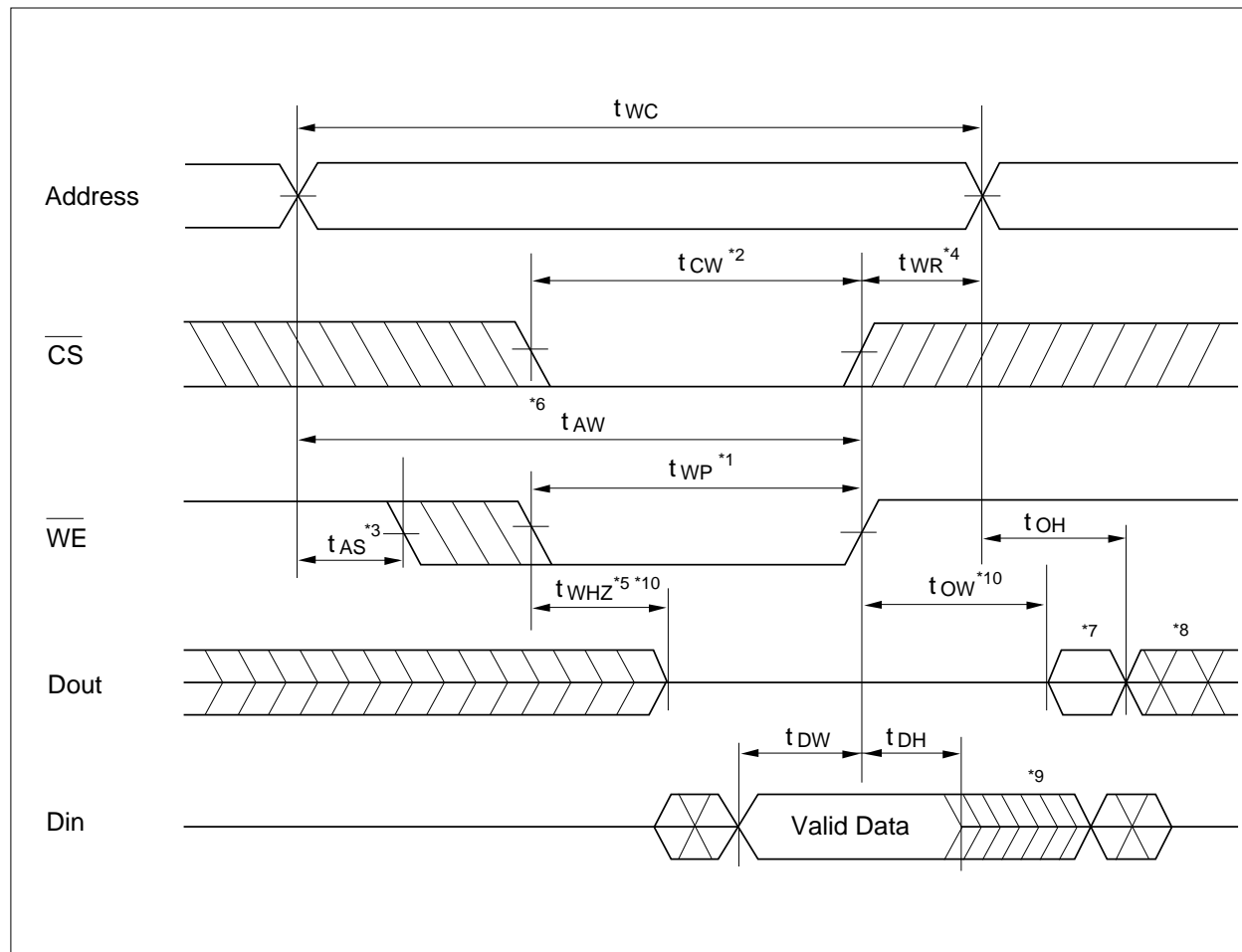
Write Timing Waveform (2) ( $\overline{\text{OE}}$  Low Fixed)

- Notes:
1. A write occurs during the overlap of a low  $\overline{\text{CS}}$  and a low  $\overline{\text{WE}}$ . A write begins at the later transition of  $\overline{\text{CS}}$  going low or  $\overline{\text{WE}}$  going low. A write ends at the earlier transition of  $\overline{\text{CS}}$  going high or  $\overline{\text{WE}}$  going high.  $t_{\text{WP}}$  is measured from the beginning of write to the end of write.
  2.  $t_{\text{CW}}$  is measured from  $\overline{\text{CS}}$  going low to the end of write.
  3.  $t_{\text{AS}}$  is measured from the address valid to the beginning of write.
  4.  $t_{\text{WR}}$  is measured from the earlier of  $\overline{\text{WE}}$  or  $\overline{\text{CS}}$  going high to the end of write cycle.
  5. During this period, I/O pins are in the output state so that the input signals of the opposite phase to the outputs must not be applied.
  6. If the  $\overline{\text{CS}}$  low transition occurs simultaneously with the  $\overline{\text{WE}}$  low transition or after the  $\overline{\text{WE}}$  transition, the output remain in a high impedance state.
  7. Dout is the same phase of the write data of this write cycle.
  8. Dout is the read data of next address.
  9. If  $\overline{\text{CS}}$  is low during this period, I/O pins are in the output state. Therefore, the input signals of the opposite phase to the output must not be applied to them.
  10. This parameter is sampled and not 100% tested.
  11.  $t_{\text{OHZ}}$  and  $t_{\text{WHZ}}$  are defined as the time at which the outputs achieve the open circuit conditions and are not referenced to output voltage levels.

Low  $V_{CC}$  Data Retention Characteristics ( $T_a = 0$  to  $+70^\circ\text{C}$ )

This characteristics is guaranteed only for L/L-SL version.

Parameter	Symbol	Min	Typ <sup>*1</sup>	Max	Unit	Test conditions
$V_{CC}$ for data retention	$V_{DR}$	2	—	—	V	$\overline{CS} \geq V_{CC} - 0.2 \text{ V}$ , $V_{in} \geq 0 \text{ V}$
Data retention current	$I_{CCDR}$	—	0.2	$30^{*2}$	$\mu\text{A}$	$V_{CC} = 3.0 \text{ V}$ , $V_{in} \geq 0 \text{ V}$
		—	0.2	$10^{*3}$	$\mu\text{A}$	$\overline{CS} \geq V_{CC} - 0.2 \text{ V}$
Chip deselect to data retention time	$t_{CDR}$	0	—	—	ns	See retention waveform
Operation recovery time	$t_R$	$t_{RC}^{*4}$	—	—	ns	

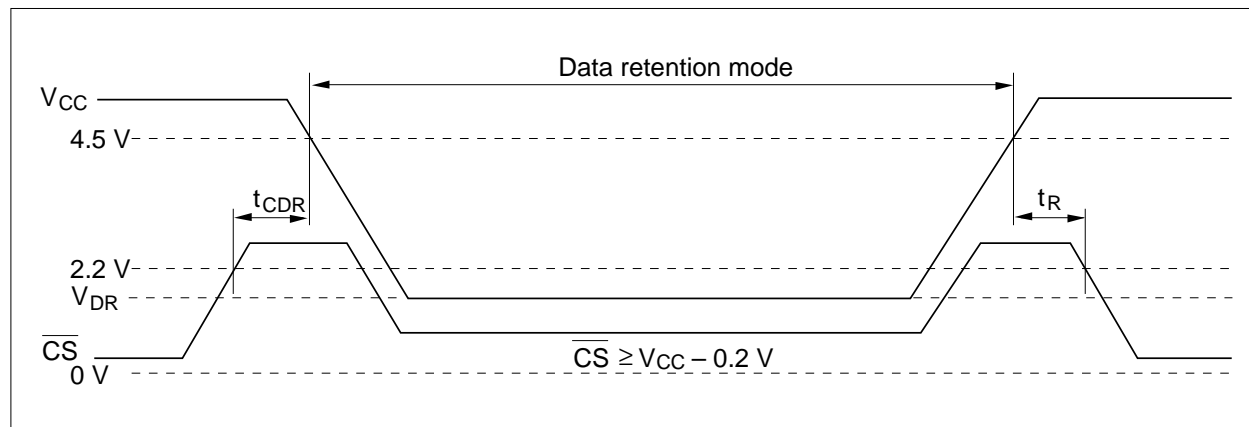
Low  $V_{CC}$  Data Retention Timing Waveform

- Notes:
- 1 Typical values are at  $V_{CC} = 3.0 \text{ V}$ ,  $T_a = +25^\circ\text{C}$  and not guaranteed.
  - 2  $20 \mu\text{A}$  max at  $T_a = 0$  to  $+40^\circ\text{C}$ . (only for L-version)
  - 3  $3 \mu\text{A}$  max at  $T_a = 0$  to  $+40^\circ\text{C}$ . (only for L-SL version)
  - 4  $t_{RC}$  = read cycle time.
  - 5  $\overline{CS}$  controls address buffer,  $\overline{WE}$  buffer,  $\overline{OE}$  buffer, and Din buffer. If  $\overline{CS}$  controls data retention mode,  $V_{in}$  levels (address,  $\overline{WE}$ ,  $\overline{OE}$ , I/O) can be in the high impedance state.