



M24M01

1 Mbit Serial I²C Bus EEPROM

FEATURES SUMMARY

- 400 kHz High Speed Two Wire I²C Serial Interface
- Single Supply Voltage:
 - 2.7V to 3.6V for M24M01-V
 - 1.8V to 3.6V for M24M01-S
- Write Control Input
- BYTE and PAGE WRITE (up to 128 Bytes)
- RANDOM and SEQUENTIAL READ Modes
- Self-Timed Programming Cycle
- Automatic Address Incrementing
- Enhanced ESD/Latch-Up Behavior
- More than 100000 Erase/Write Cycles
- More than 40 Year Data Retention

Figure 1. Packages

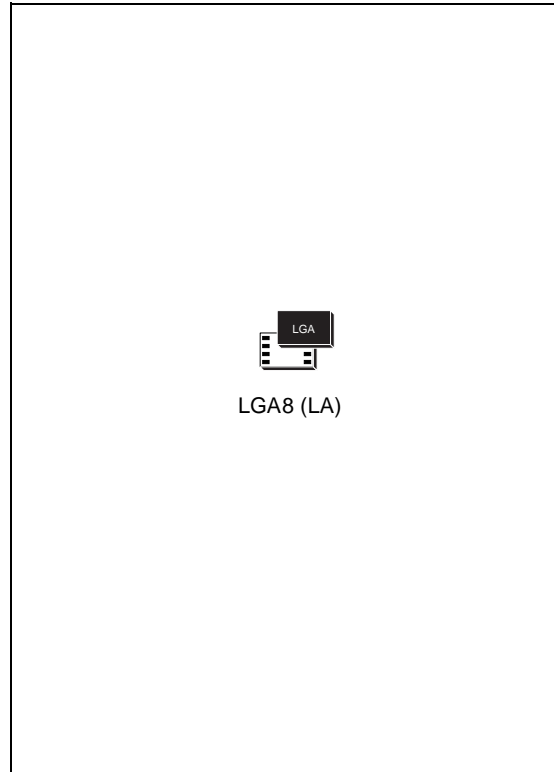

M24M01

SUMMARY DESCRIPTION

The M24M01 is a 1 Mbit (131,072 x 8) electrically erasable programmable memory (EEPROM) accessed by an I²C-compatible bus.

Figure 2. Logic Diagram

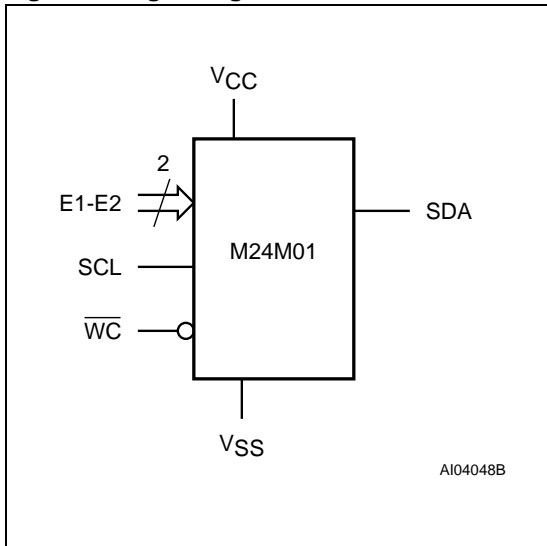

Table 1. Signal Names

E1, E2	Chip Enable
SDA	Serial Data
SCL	Serial Clock
\overline{WC}	Write Control
VCC	Supply Voltage
VSS	Ground

These devices are compatible with the I²C memory protocol. This is a two wire serial interface that uses a bi-directional data bus and serial clock. The devices carry a built-in 4-bit Device Type Identifier code (1010) in accordance with the I²C bus definition.

The device behaves as a slave in the I²C protocol, with all memory operations synchronized by the serial clock. Read and Write operations are initiated by a Start condition, generated by the bus master. The Start condition is followed by a Device Select Code and \overline{RW} bit (as described in Table 2), terminated by an acknowledge bit.

When writing data to the memory, the device inserts an acknowledge bit during the 9th bit time, following the bus master's 8-bit transmission. When data is read by the bus master, the bus master acknowledges the receipt of the data byte in the same way. Data transfers are terminated by a Stop condition after an Ack for Write, and after a NoAck for Read.

Figure 3. LGA Connections

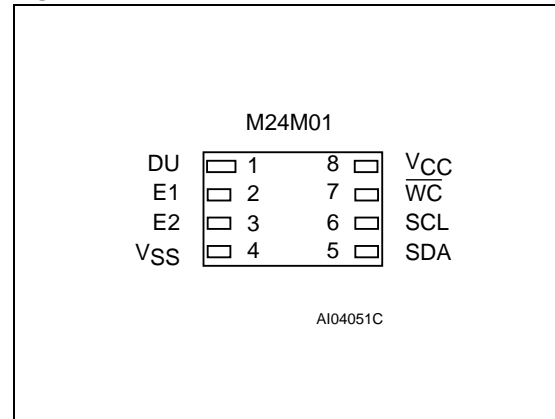

Note: 1. DU = Don't Use (should be left unconnected, or tied to V_{SS})

Power On Reset: VCC Lock-Out Write Protect

In order to prevent data corruption and inadvertent Write operations during Power-up, a Power On Reset (POR) circuit is included. The internal reset is held active until V_{CC} has reached the POR threshold value, and all operations are disabled – the device will not respond to any command. In the same way, when V_{CC} drops from the operating voltage, below the POR threshold value, all operations are disabled and the device will not respond to any command. A stable and valid V_{CC} must be applied before applying any logic signal.

When the power supply is turned on, V_{CC} rises from V_{SS} to V_{CC}(min), passing through a value V_{th} in between. The device ignores all instructions until a time delay of t_{PU} has elapsed after the moment that V_{CC} rises above the V_{th} threshold. However, the correct operation of the device is not guaranteed if, by this time, V_{CC} is still below V_{CC}(min). No instructions should be sent until the later of:

- t_{PU} after V_{CC} passed the V_{th} threshold
- V_{CC} passed the V_{CC}(min) level

These values are specified in Table 9.

SIGNAL DESCRIPTION

Serial Clock (SCL)

This input signal is used to strobe all data in and out of the device. In applications where this signal is used by slave devices to synchronize the bus to a slower clock, the bus master must have an open drain output, and a pull-up resistor must be connected from Serial Clock (SCL) to V_{CC} . (Figure 4 indicates how the value of the pull-up resistor can be calculated). In most applications, though, this method of synchronization is not employed, and so the pull-up resistor is not necessary, provided that the bus master has a push-pull (rather than open drain) output.

Serial Data (SDA)

This bi-directional signal is used to transfer data in or out of the device. It is an open drain output that may be wire-OR'ed with other open drain or open collector signals on the bus. A pull up resistor must be connected from Serial Data (SDA) to V_{CC} . (Figure 4 indicates how the value of the pull-up resistor can be calculated).

Chip Enable (E1, E2)

These input signals are used to set the value that is to be looked for on bits b3 and b2 of the 7-bit Device Select Code. These inputs must be tied to V_{CC} or V_{SS} , to establish the Device Select Code. When unconnected, the Chip Enable (E1, E2) signals are internally read as V_{IL} (see Tables 10 and 11).

Write Control (\overline{WC})

This input signal is useful for protecting the entire contents of the memory from inadvertent write operations. Write operations are disabled to the entire memory array when Write Control (\overline{WC}) is driven High. When unconnected, the signal is internally read as V_{IL} , and Write operations are allowed.

When Write Control (\overline{WC}) is driven High, Device Select and Address bytes are acknowledged, Data bytes are not acknowledged.

Figure 4. Maximum R_L Value versus Bus Capacitance (C_{BUS}) for an I²C Bus

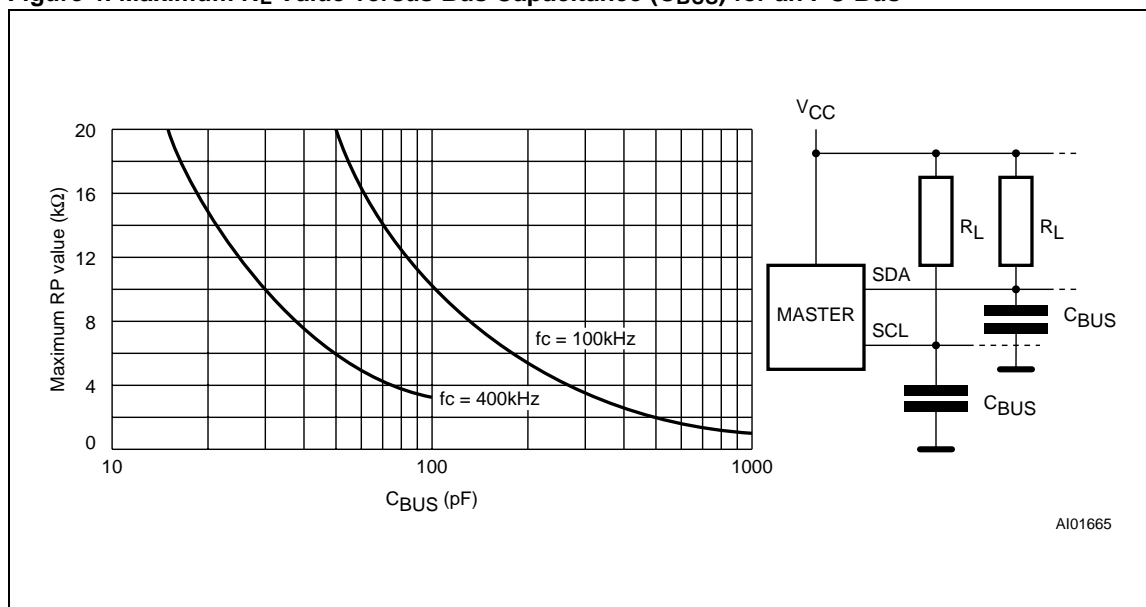

DEVICE OPERATION

The device supports the I²C protocol. This is summarized in Figure 2. Any device that sends data on to the bus is defined to be a transmitter, and any device that reads the data to be a receiver. The device that controls the data transfer is known as the bus master, and the other as the slave device. A data transfer can only be initiated by the bus master, which will also provide the serial clock for synchronization. The M24M01 device is always a slave in all communication.

Start Condition

Start is identified by a falling edge of Serial Data (SDA) while Serial Clock (SCL) is stable in the High state. A Start condition must precede any data transfer command. The device continuously monitors (except during a Write cycle) Serial Data (SDA) and Serial Clock (SCL) for a Start condition, and will not respond unless one is given.

Stop Condition

Stop is identified by a rising edge of Serial Data (SDA) while Serial Clock (SCL) is stable and driven High. A Stop condition terminates communication between the device and the bus master. A Read command that is followed by NoAck can be followed by a Stop condition to force the device into the Stand-by mode. A Stop condition at the end of a Write command triggers the internal EEPROM Write cycle.

Acknowledge Bit (ACK)

The acknowledge bit is used to indicate a successful byte transfer. The bus transmitter, whether it be bus master or slave device, releases Serial Data (SDA) after sending eight bits of data. During the 9th clock pulse period, the receiver pulls Serial Data (SDA) Low to acknowledge the receipt of the eight data bits.

Data Input

During data input, the device samples Serial Data (SDA) on the rising edge of Serial Clock (SCL). For correct device operation, Serial Data (SDA) must be stable during the rising edge of Serial Clock (SCL), and the Serial Data (SDA) signal must change *only* when Serial Clock (SCL) is driven Low.

Memory Addressing

To start communication between the bus master and the slave device, the bus master must initiate a Start condition. Following this, the bus master sends the Device Select Code, shown in Table 2 (on Serial Data (SDA), most significant bit first).

The Device Select Code consists of a 4-bit Device Type Identifier, and a 2-bit Chip Enable "Address" (E1, E2). To address the memory array, the 4-bit Device Type Identifier is 1010b.

Up to four memory devices can be connected on a single I²C bus. Each one is given a unique 2-bit code on the Chip Enable (E1, E2) inputs. When the Device Select Code is received on Serial Data (SDA), the device only responds if the Chip Enable Address is the same as the value on the Chip Enable (E1, E2) inputs.

The 8th bit is the Read/Write bit (\overline{RW}). This bit is set to 1 for Read and 0 for Write operations.

If a match occurs on the Device Select code, the corresponding device gives an acknowledgment on Serial Data (SDA) during the 9th bit time. If the device does not match the Device Select code, it deselects itself from the bus, and goes into Stand-by mode.

Table 2. Device Select Code ¹

	Device Type Identifier				Chip Enable Address			\overline{RW}
	b7	b6	b5	b4	b3	b2	b1	b0
Device Select Code	1	0	1	0	E2	E1	A16	\overline{RW}

Note: 1. The most significant bit, b7, is sent first.

Figure 5. I²C Bus Protocol

Table 3. Operating Modes

Mode	R \bar{W} bit	$\bar{W}C$ ¹	Bytes	Initial Sequence
Current Address Read	1	X	1	START, Device Select, R \bar{W} = 1
Random Address Read	0	X	1	START, Device Select, R \bar{W} = 0, Address
	1	X		reSTART, Device Select, R \bar{W} = 1
Sequential Read	1	X	≥ 1	Similar to Current or Random Address Read
Byte Write	0	V _{IL}	1	START, Device Select, R \bar{W} = 0
Page Write	0	V _{IL}	≤ 128	START, Device Select, R \bar{W} = 0

Note: 1. X = V_{IH} or V_{IL}.

Figure 6. Write Mode Sequences with $\overline{WC}=1$ (data write inhibited)

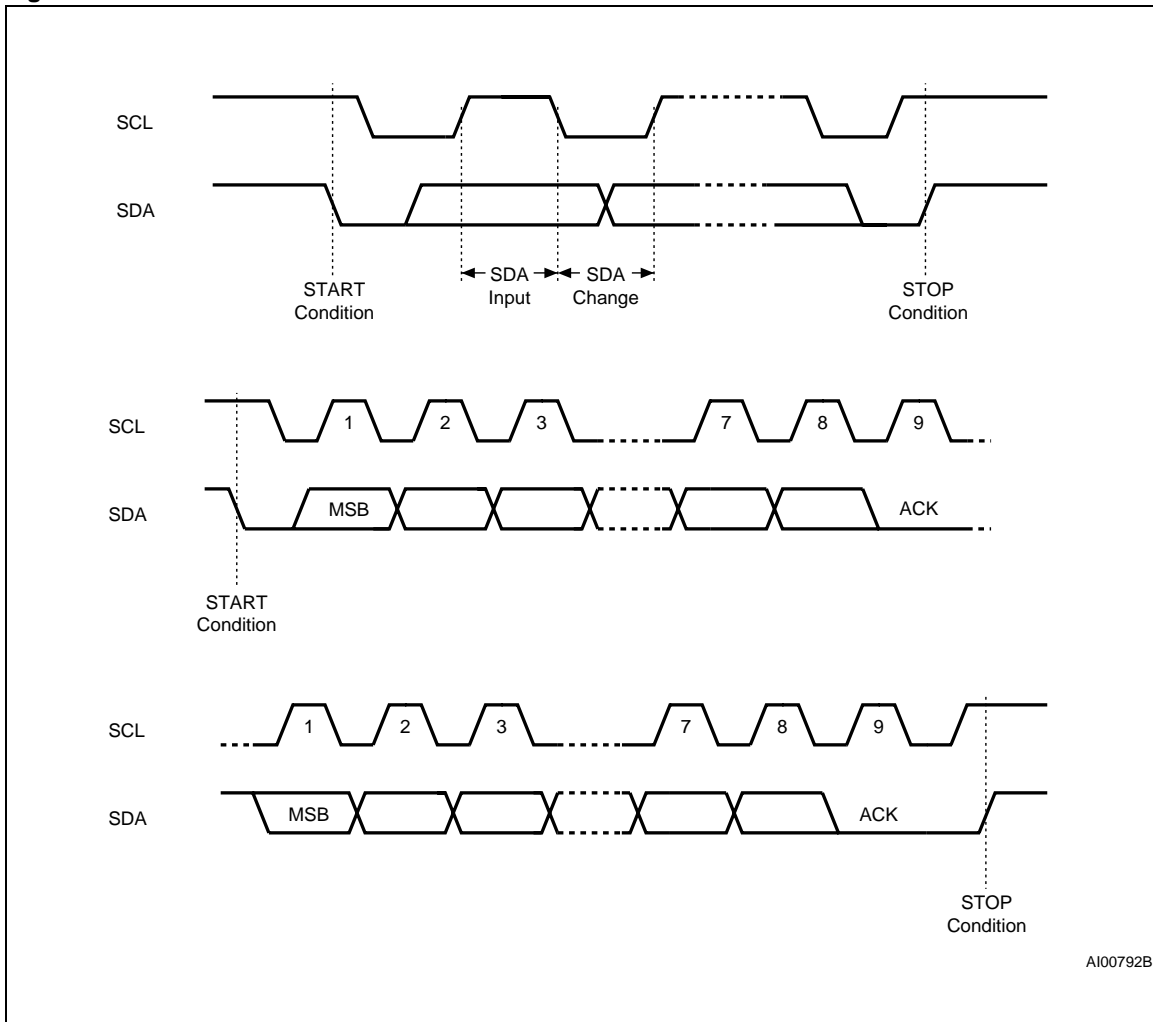
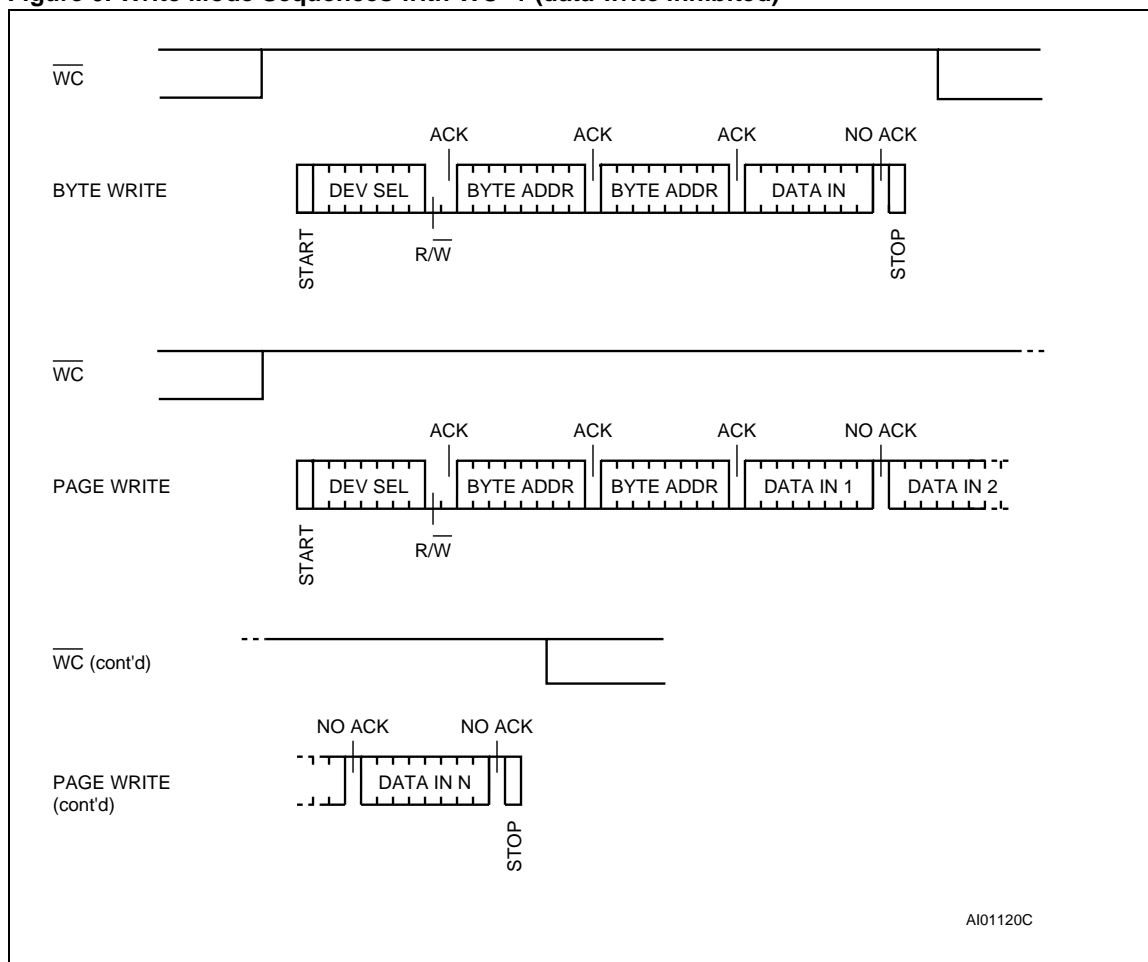
Write Operations

Following a Start condition the bus master sends a Device Select Code with the R/W bit reset to 0. The device acknowledges this, as shown in Figure 7, and waits for two address bytes. The device responds to each address byte with an acknowledge bit, and then waits for the data byte.

Writing to the memory may be inhibited if Write Control (\overline{WC}) is driven High. Any Write instruction with Write Control (\overline{WC}) driven High (during a period of time from the Start condition until the end of the two address bytes) will not modify the memory contents, and the accompanying data bytes are *not* acknowledged, as shown in Figure 6.

Each data byte in the memory has a 17-bit address. The most significant bit, A16, is sent with the Device Select Code, and the remaining bits, A15-A0, in the two address bytes. The Most Significant Byte is sent first, followed by the Least Sig-

nificant Byte. Bits A16 to A0 form the address of the byte in memory.

When the bus master generates a Stop condition immediately after the Ack bit (in the "10th" bit time slot), either at the end of a Byte Write or a Page Write, the internal memory Write cycle is triggered. A Stop condition at any other time slot does not trigger the internal Write cycle.

During the internal Write cycle, Serial Data (SDA) is disabled internally, and the device does not respond to any requests.

Byte Write

After the Device Select code and the address bytes, the bus master sends one data byte. If the addressed location is Write-protected, by Write Control (\overline{WC}) being driven High, the device replies with NoAck, and the location is not modified. If, instead, the addressed location is not Write-protected, the device replies with Ack. The bus master

terminates the transfer by generating a Stop condition, as shown in Figure 7.

Page Write

The Page Write mode allows up to 128 bytes to be written in a single Write cycle, provided that they are all located in the same 'row' in the memory: that is, the most significant memory address bits (b16-b7) are the same. If more bytes are sent than will fit up to the end of the row, a condition known as 'roll-over' occurs. This should be avoided, as data starts to become overwritten in an implementation dependent way.

The bus master sends from 1 to 128 bytes of data, each of which is acknowledged by the device if Write Control (\overline{WC}) is Low. If Write Control (\overline{WC}) is High, the contents of the addressed memory location are not modified, and each data byte is followed by a NoAck. After each byte is transferred, the internal byte address counter (the 7 least significant address bits only) is incremented. The transfer is terminated by the bus master generating a Stop condition.

Figure 7. Write Mode Sequences with $\overline{WC}=0$ (data write enabled)

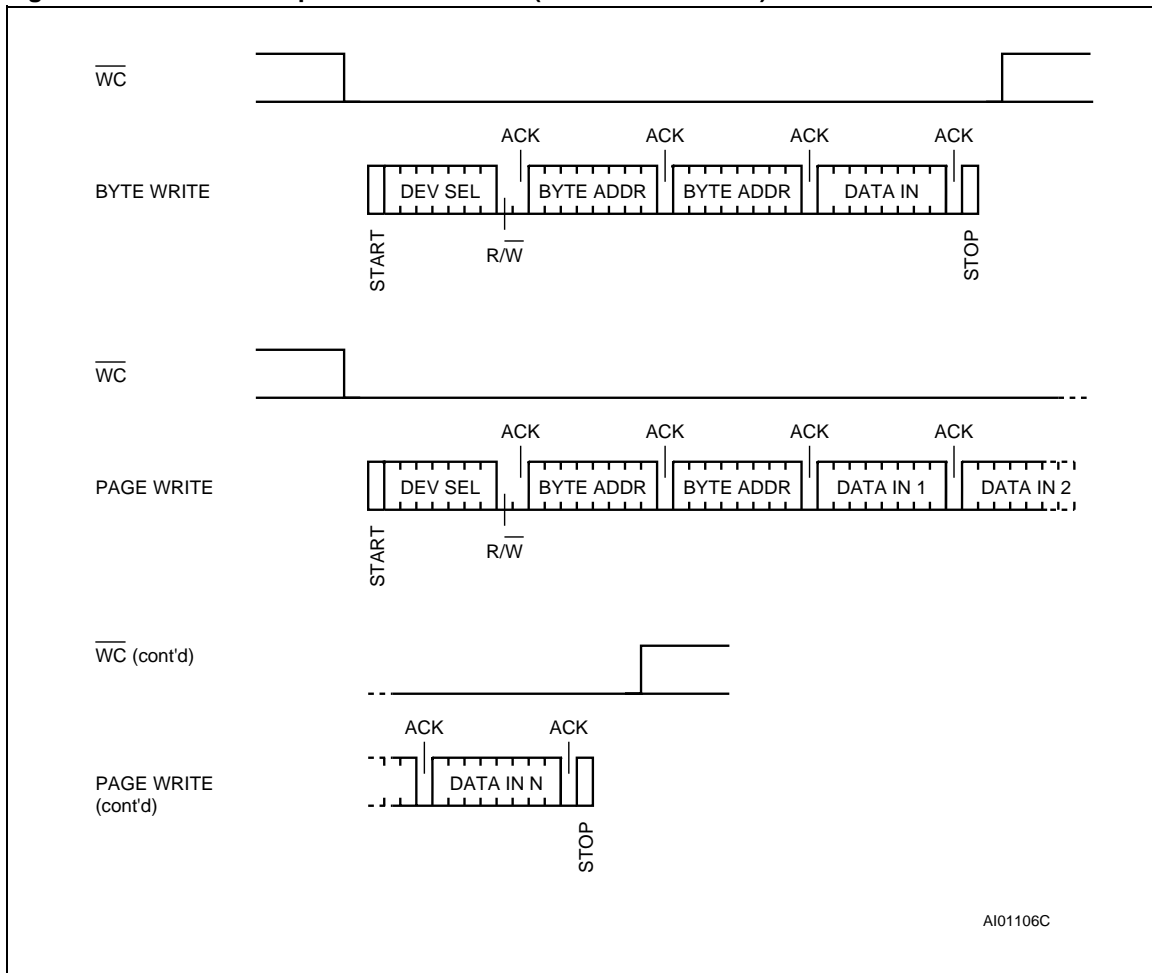
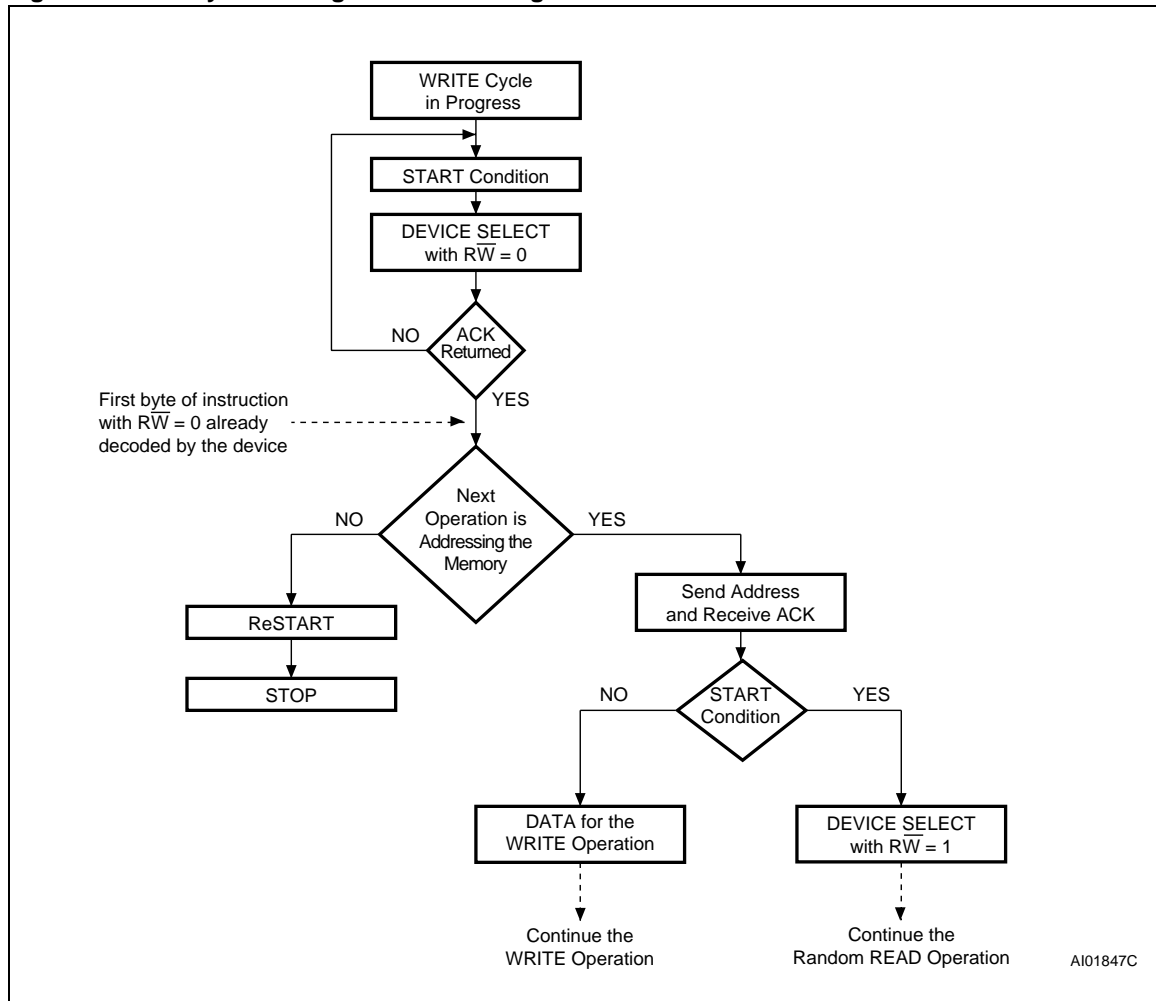

Figure 8. Write Cycle Polling Flowchart using ACK



Minimizing System Delays by Polling On ACK

During the internal Write cycle, the device disconnects itself from the bus, and writes a copy of the data from its internal latches to the memory cells. The maximum Write time (t_w) is shown in Table 12, but the typical time is shorter. To make use of this, a polling sequence can be used by the bus master.

The sequence, as shown in Figure 8, is:

- Initial condition: a Write cycle is in progress.

- Step 1: the bus master issues a Start condition followed by a Device Select Code (the first byte of the new instruction).
- Step 2: if the device is busy with the internal Write cycle, no Ack will be returned and the bus master goes back to Step 1. If the device has terminated the internal Write cycle, it responds with an Ack, indicating that the device is ready to receive the second part of the instruction (the first byte of this instruction having been sent during Step 1).

Figure 9. Read Mode Sequences

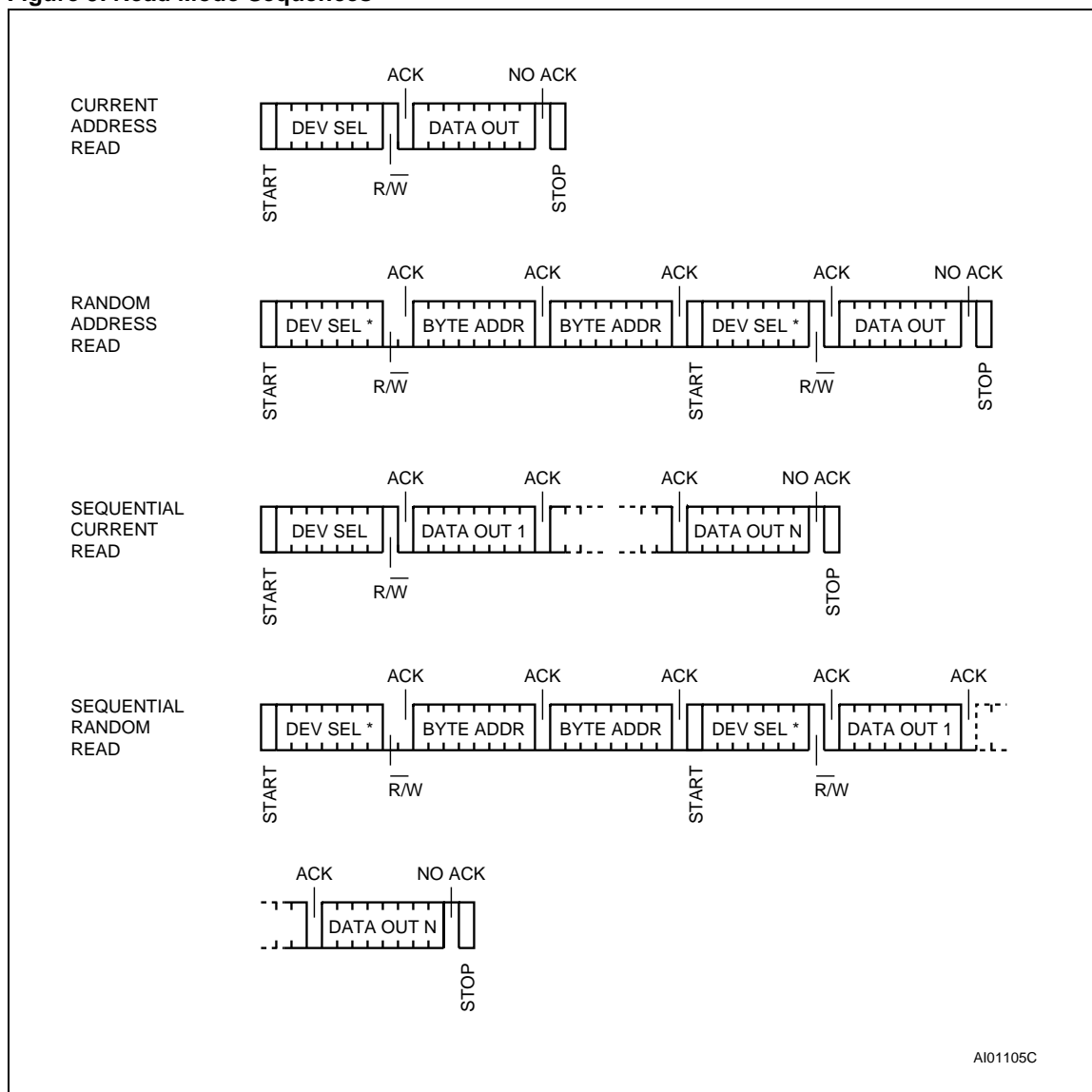

Note: 1. The seven most significant bits of the Device Select Code of a Random Read (in the 1st and 4th bytes) must be identical.

Read Operations

Read operations are performed independently of the state of the Write Control (\overline{WC}) signal.

Random Address Read

A dummy Write is performed to load the address into the address counter (as shown in Figure 9) but *without* sending a Stop condition. Then, the bus master sends another Start condition, and repeats the Device Select Code, with the \overline{RW} bit set to 1. The device acknowledges this, and outputs the contents of the addressed byte. The bus master

must *not* acknowledge the byte, and terminates the transfer with a Stop condition.

Current Address Read

The device has an internal address counter which is incremented each time a byte is read. For the Current Address Read operation, following a Start condition, the bus master only sends a Device Select Code with the \overline{RW} bit set to 1. The device acknowledges this, and outputs the byte addressed by the internal address counter. The counter is then incremented. The bus master terminates the

transfer with a Stop condition, as shown in Figure 9, *without* acknowledging the byte.

Sequential Read

This operation can be used after a Current Address Read or a Random Address Read. The bus master *does* acknowledge the data byte output, and sends additional clock pulses so that the device continues to output the next byte in sequence. To terminate the stream of bytes, the bus master must *not* acknowledge the last byte, and *must* generate a Stop condition, as shown in Figure 9.

The output data comes from consecutive addresses, with the internal address counter automatically

incremented after each byte output. After the last memory address, the address counter 'rolls-over', and the device continues to output data from memory address 00h.

Acknowledge in Read Mode

For all Read commands, the device waits, after each byte read, for an acknowledgment during the 9th bit time. If the bus master does not drive Serial Data (SDA) Low during this time, the device terminates the data transfer and switches to its Stand-by mode.

MAXIMUM RATING

Stressing the device above the rating listed in the Absolute Maximum Ratings" table may cause permanent damage to the device. These are stress ratings only and operation of the device at these or any other conditions above those indicated in the Operating sections of this specification is not im-

plied. Exposure to Absolute Maximum Rating conditions for extended periods may affect device reliability. Refer also to the STMicroelectronics SURE Program and other relevant quality documents.

Table 4. Absolute Maximum Ratings

Symbol	Parameter	Min.	Max.	Unit
T _{STG}	Storage Temperature	-65	150	°C
T _{LEAD}	Lead Temperature during Soldering LGA: 20 seconds (max) ¹		235	°C
V _{IO}	Input or Output range	-0.6	4.2	V
V _{CC}	Supply Voltage	-0.3	4.2	V
V _{ESD}	Electrostatic Discharge Voltage (Human Body model) ²	-3000	3000	V

Note: 1. IPC/JEDEC J-STD-020A

2. JEDEC Std JESD22-A114A (C1=100 pF, R1=1500 Ω, R2=500 Ω)

M24M01

DC AND AC PARAMETERS

This section summarizes the operating and measurement conditions, and the DC and AC characteristics of the device. The parameters in the DC and AC Characteristic tables that follow are derived from tests performed under the Measure-

ment Conditions summarized in the relevant tables. Designers should check that the operating conditions in their circuit match the measurement conditions when relying on the quoted parameters.

Table 5. Operating Conditions (M24M01-V)

Symbol	Parameter	Min.	Max.	Unit
V_{CC}	Supply Voltage	2.7	3.6	V
T_A	Ambient Operating Temperature	-40	85	°C

Table 6. Operating Conditions (M24M01-S)

Symbol	Parameter	Min.	Max.	Unit
V_{CC}	Supply Voltage	1.8	3.6	V
T_A	Ambient Operating Temperature	-40	85	°C

Table 7. AC Measurement Conditions

Symbol	Parameter	Min.	Max.	Unit
C_L	Load Capacitance	30		pF
	Input Rise and Fall Times		50	ns
	Input Pulse Voltages	0.2V _{CC} to 0.8V _{CC}		V
	Input and Output Timing Reference Voltages	0.3V _{CC} to 0.7V _{CC}		V

Note: 1. Output Hi-Z is defined as the point where data out is no longer driven.

Figure 10. AC Measurement I/O Waveform

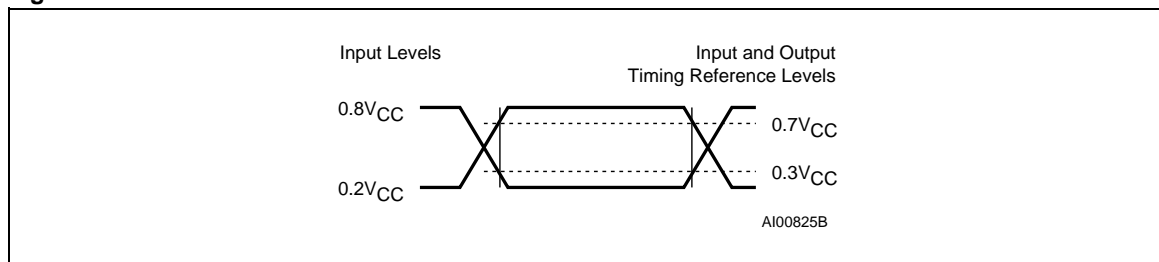

Table 8. Capacitance

Symbol	Parameter	Test Condition	Min.	Max.	Unit
C_{IN}	Input Capacitance (SDA)			8	pF
C_{IN}	Input Capacitance (other pins)			6	pF
t_{NS}	Pulse width ignored (Input Filter on SCL and SDA)			50	ns

Note: 1. $T_A = 25\text{ °C}$, $f = 400\text{ kHz}$
2. Sampled only, not 100% tested.

Table 9. Power-Up Timing and V_{th} Threshold

Symbol	Parameter	Test Condition ¹	Min.	Max.	Unit
t_{PU}	Time delay to Read or Write instruction			200	μs
V_{th}	Threshold Voltage		1.1	1.4	V

Note: 1. These parameters are characterized only.

Table 10. DC Characteristics (M24M01-V)

Symbol	Parameter	Test Condition (in addition to those in Table 5)	Min.	Max.	Unit
I_{LI}	Input Leakage Current (SCL, SDA, E1, E2, \overline{WC})	$V_{IN} = V_{SS}$ or V_{CC}		± 1	μA
I_{LO}	Output Leakage Current	$0 V \leq V_{OUT} \leq V_{CC}$, SDA in Hi-Z		± 2	μA
I_{CC}	Supply Current	$V_{CC} = 3.6V$, $f_c = 400kHz$ (rise/fall time < 30ns)		2	mA
I_{CC1}	Stand-by Supply Current	$V_{IN} = V_{SS}$ or V_{CC} , $2.7 V \leq V_{CC} \leq 3.6 V$		2	μA
V_{IL}	Input Low Voltage (E1, E2, SCL, SDA, \overline{WC})		- 0.3	$0.3V_{CC}$	V
V_{IH}	Input High Voltage (E1, E2, SCL, SDA, \overline{WC})		$0.7V_{CC}$	$V_{CC} + 1$	V
V_{OL}	Output Low Voltage	$I_{OL} = 2.5 mA$, $2.7 V \leq V_{CC} \leq 3.6 V$		0.4	V

Table 11. DC Characteristics (M24M01-S)

Symbol	Parameter	Test Condition (in addition to those in Table 6)	Min.	Max.	Unit
I_{LI}	Input Leakage Current (SCL, SDA, E1, E2, \overline{WC})	$V_{IN} = V_{SS}$ or V_{CC}		± 1	μA
I_{LO}	Output Leakage Current	$0 V \leq V_{OUT} \leq V_{CC}$, SDA in Hi-Z		± 2	μA
I_{CC}	Supply Current	$V_{CC} = 3.6V$, $f_c = 400kHz$ (rise/fall time < 30ns)		2	mA
I_{CC1}	Stand-by Supply Current	$V_{IN} = V_{SS}$ or V_{CC} , $V_{CC} = 3.6 V$		2	μA
V_{IL}	Input Low Voltage (E1, E2, SCL, SDA, \overline{WC})		- 0.3	$0.3V_{CC}$	V
V_{IH}	Input High Voltage (E1, E2, SCL, SDA, \overline{WC})		$0.7V_{CC}$	$V_{CC} + 1$	V
V_{OL}	Output Low Voltage	$I_{OL} = 2.5 mA$, $2.7 V \leq V_{CC} \leq 3.6 V$		0.4	V
		$R_L = 2.2 k\Omega$, $1.8 V \leq V_{CC} \leq 3.6 V$		$0.2V_{CC}$	V

Table 12. AC Characteristics

Test conditions specified in Table 7 and Table 5 or Table 6					
Symbol	Alt.	Parameter	Min.	Max.	Unit
f_C	f_{SCL}	Clock Frequency		400	kHz
t_{CH1CH2}	t_R	Clock Rise Time	20	300	ns
t_{CL1CL2}	t_F	Clock Fall Time	20	300	ns
t_{CHCL}	t_{HIGH}	Clock Pulse Width High	600		ns
t_{CLCH}	t_{LOW}	Clock Pulse Width Low	1300		ns
t_{DH1DH2}^2	t_R	SDA Rise Time	20	300	ns
t_{DL1DL2}^2	t_F	SDA Fall Time	20	300	ns
t_{DXCX}	$t_{SU:DAT}$	Data In Set Up Time	100		ns
t_{CLDX}	$t_{HD:DAT}$	Data In Hold Time	0		ns
t_{CLQX}	t_{DH}	Data Out Hold Time	200		ns
t_{CLQV}^3	t_{AA}	Clock Low to Next Data Valid (Access Time)	205	900	ns
t_{CHDX}^1	$t_{SU:STA}$	Start Condition Set Up Time	600		ns
t_{DLCL}	$t_{HD:STA}$	Start Condition Hold Time	600		ns
t_{CHDH}	$t_{SU:STO}$	Stop Condition Set Up Time	600		ns
t_{DHDL}	t_{BUF}	Time between Stop Condition and Next Start Condition	1300		ns
t_W	t_{WR}	Write Time		10	ms

Note: 1. For a reSTART condition, or following a Write cycle.

2. Sampled only, not 100% tested.

3. To avoid spurious START and STOP conditions, a minimum delay is placed between SCL=1 and the falling or rising edge of SDA.

Figure 11. AC Waveforms

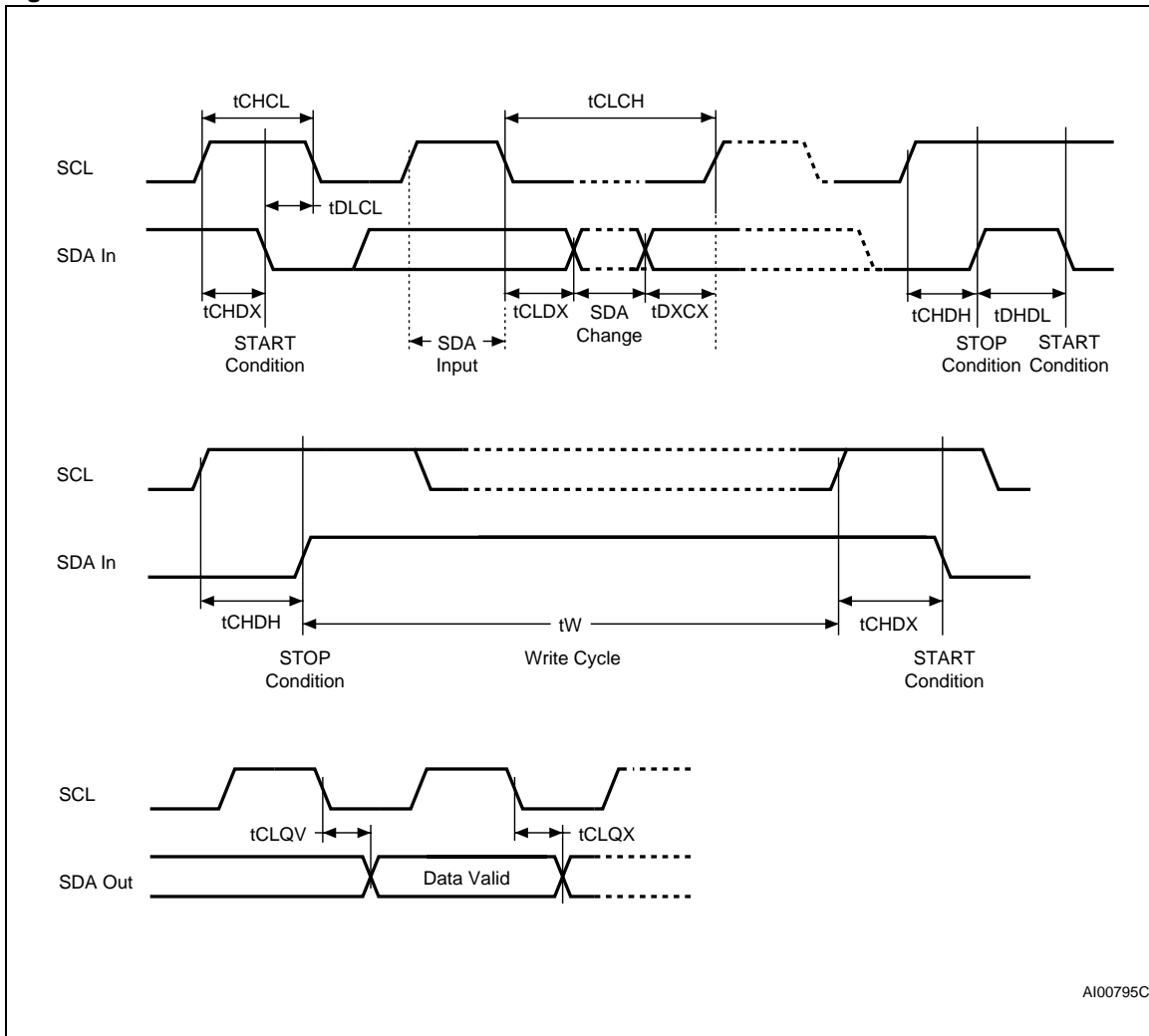

M24M01

PACKAGE MECHANICAL

LGA8 - 8 lead Land Grid Array, Package Outline

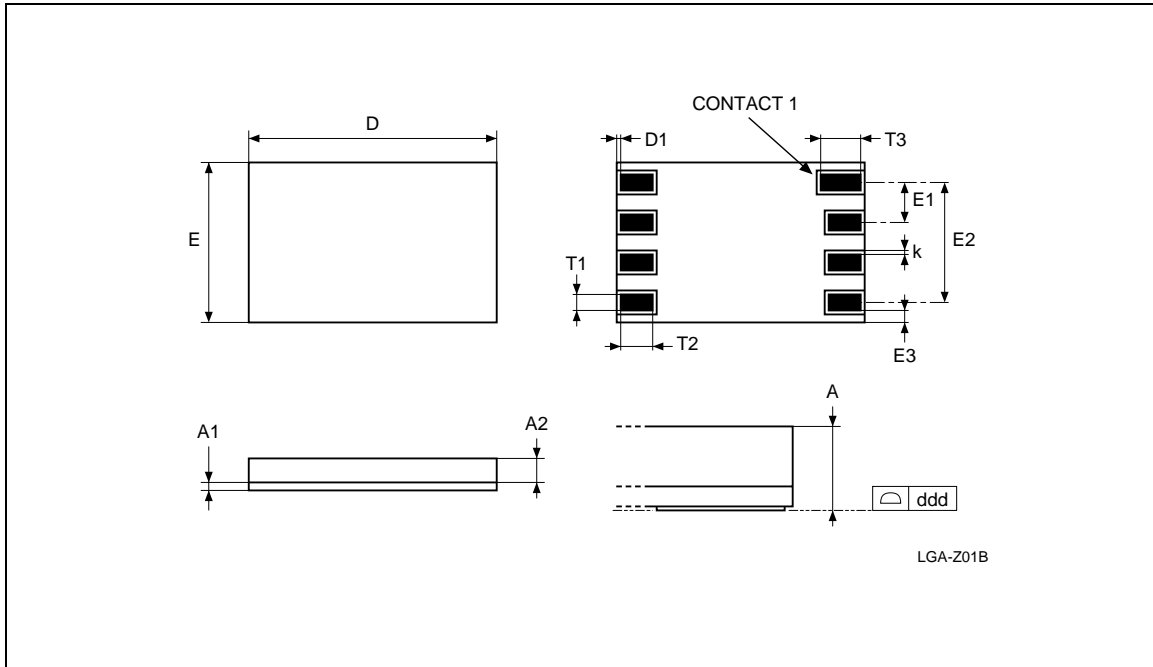

Notes: 1. Drawing is not to scale.

LGA8 - 8 lead Land Grid Array, Package Mechanical Data

Symb.	mm			inches		
	Typ.	Min.	Max.	Typ.	Min.	Max.
A	1.040	0.940	1.140	0.0409	0.0370	0.0449
A1	0.340	0.300	0.380	0.0134	0.0118	0.0150
A2	0.700	0.640	0.760	0.0276	0.0252	0.0299
D	8.000	7.900	8.100	0.3150	0.3110	0.3189
D1	0.100	–	–	0.0039	–	–
E	5.000	4.900	5.100	0.1969	0.1929	0.2008
E1	1.270	–	–	0.0500	–	–
E2	3.810	–	–	0.1500	–	–
E3	0.390	–	–	0.0154	–	–
k	0.100	–	–	0.0039	–	–
T1	0.410	–	–	0.0161	–	–
T2	0.670	–	–	0.0264	–	–
T3	0.970	–	–	0.0382	–	–
ddd	0.100	–	–	0.0039	–	–

PART NUMBERING

Table 13. Ordering Information Scheme

Example:	M24M01	-	V	LA	6	T
Device Type						
M24 = I ² C serial access EEPROM						
Device Function						
M01 = 1 Mbit (131,072 x 8)						
Operating Voltage						
V = V _{CC} = 2.7 to 3.6V						
S = V _{CC} = 1.8 to 3.6V						
Package						
LA = LGA8 (Land Grid Array)						
Temperature Range						
6 = -40 to 85 °C						
Option						
T = Tape & Reel Packing						

For a list of available options (speed, package, etc.) or for further information on any aspect of this

device, please contact your nearest ST Sales Office.

REVISION HISTORY**Table 14. Document Revision History**

Date	Rev.	Description of Revision
02-Oct-2001	1.0	LGA8 Package mechanical data updated Datasheet released as Product Preview
21-Jun-2002	1.1	Table added on Power-up Timing Full Datasheet released
08-Jan-2003	1.2	Added LGA maximum rating for soldering temperature

Information furnished is believed to be accurate and reliable. However, STMicroelectronics assumes no responsibility for the consequences of use of such information nor for any infringement of patents or other rights of third parties which may result from its use. No license is granted by implication or otherwise under any patent or patent rights of STMicroelectronics. Specifications mentioned in this publication are subject to change without notice. This publication supersedes and replaces all information previously supplied. STMicroelectronics products are not authorized for use as critical components in life support devices or systems without express written approval of STMicroelectronics.

The ST logo is registered trademark of STMicroelectronics
All other names are the property of their respective owners

© 2003 STMicroelectronics - All Rights Reserved

STMicroelectronics group of companies

Australia - Brazil - Canada - China - Finland - France - Germany - Hong Kong -
India - Israel - Italy - Japan - Malaysia - Malta - Morocco - Singapore - Spain - Sweden - Switzerland - United Kingdom - United States.

www.st.com

