

# LMP7731

## 2.9 nV/sqrt(Hz) Low Noise, Precision, RRIO Amplifier

### General Description

The LMP7731 is a single, low noise, rail-to-rail input and output, low voltage amplifier. The LMP7731 is part of the LMP® precision amplifier family and is ideal for precision and low noise applications with low voltage requirements.

This operational amplifier offers low voltage noise of 2.9 nV/√Hz with a 1/f corner of only 3 Hz. The LMP7731 has bipolar input stages with a bias current of only 1.5 nA. This low input bias current, complemented by the very low level of voltage noise, makes the LMP7731 an excellent choice for photometry applications.

The LMP7731 provides a wide GBW of 22 MHz while consuming only 2 mA of current. This high gain bandwidth along with the high open loop gain of 130 dB enables accurate signal conditioning in applications with high closed loop gain requirements.

The LMP7731 has a supply voltage range of 1.8V to 5.5V, making it an ideal choice for battery operated portable applications.

The LMP7731 is offered in the space saving 5-Pin SOT-23 and 8-Pin SOIC packages.

### Features

(Typical values,  $T_A = 25^\circ\text{C}$ ,  $V_S = 5\text{V}$ )

■ Input voltage noise	
— $f = 3\text{ Hz}$	3.3 nV/√Hz
— $f = 1\text{ kHz}$	2.9 nV/√Hz
■ CMRR	130 dB
■ Open loop gain	130 dB
■ GBW	22 MHz
■ Slew rate	2.4 V/μs
■ THD @ $f = 10\text{ kHz}$ , $A_V = +1$ , $R_L = 2\text{ k}\Omega$	0.001%
■ Supply current per channel	2.2 mA
■ Supply voltage range	1.8V to 5.5V
■ Operating temperature range	-40°C to 125°C
■ Input bias current	±1.5 nA
■ RRIO	

### Applications

- Gas analysis instruments
- Photometric instrumentation
- Medical instrumentation

### Typical Performance Characteristics

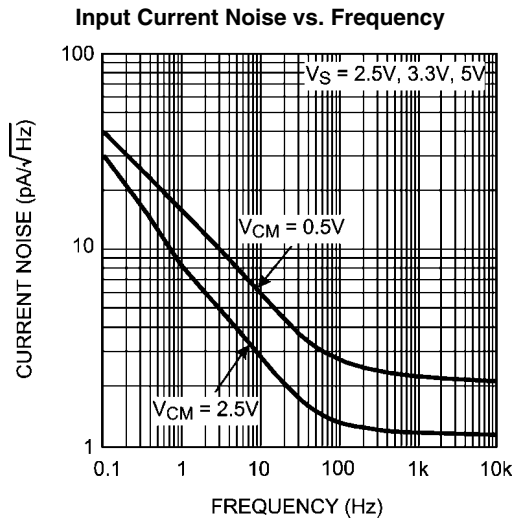
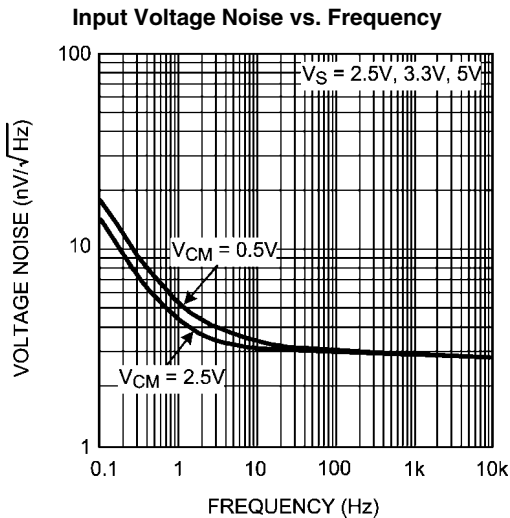

LMP® is a registered trademark of National Semiconductor Corporation.

**Absolute Maximum Ratings** (Note 1)

If Military/Aerospace specified devices are required, please contact the National Semiconductor Sales Office/Distributors for availability and specifications.

ESD Tolerance (Note 2)

Human Body Model

Inputs pins only

2000V

All other pins

2000V

Machine Model

200V

Charge Device Model

1000V

 $V_{IN}$  Differential $\pm 2V$ Supply Voltage ( $V_S = V^+ - V^-$ )

6.0V

Storage Temperature Range

-65°C to 150°C

Junction Temperature (Note 3)

+150°C max

Soldering Information

Infrared or Convection (20 sec)

235°C

Wave Soldering Lead Temp. (10 sec)

260°C

**Operating Ratings** (Note 1)

Temperature Range

-40°C to 125°C

Supply Voltage ( $V_S = V^+ - V^-$ )

1.8V to 5.5V

Package Thermal Resistance ( $\theta_{JA}$ )

5-Pin SOT-23

265°C/W

8-Pin SOIC

190°C/W

**2.5V Electrical Characteristics** (Note 4)

Unless otherwise specified, all limits are guaranteed for  $T_A = 25^\circ\text{C}$ ,  $V^+ = 2.5\text{V}$ ,  $V^- = 0\text{V}$ ,  $V_{CM} = V^+/2$ ,  $R_L > 10\text{ k}\Omega$  to  $V^+/2$ . **Bold-face** limits apply at the temperature extremes.

Symbol	Parameter	Conditions	Min (Note 6)	Typ (Note 5)	Max (Note 6)	Units
$V_{OS}$	Input Offset Voltage (Note 7)	$V_{CM} = 2.0\text{V}$		$\pm 9$	$\pm 500$ <b><math>\pm 600</math></b>	$\mu\text{V}$
		$V_{CM} = 0.5\text{V}$		$\pm 9$	$\pm 500$ <b><math>\pm 600</math></b>	
$TCV_{OS}$	Input Offset Voltage Temperature Drift	$V_{CM} = 2.0\text{V}$		$\pm 0.5$	$\pm 5.5$	$\mu\text{V}/^\circ\text{C}$
		$V_{CM} = 0.5\text{V}$		$\pm 0.2$	$\pm 5.5$	
$I_B$	Input Bias Current	$V_{CM} = 2.0\text{V}$		$\pm 1$	$\pm 30$ <b><math>\pm 45</math></b>	nA
		$V_{CM} = 0.5\text{V}$		$\pm 12$	$\pm 50$ <b><math>\pm 75</math></b>	
$I_{OS}$	Input Offset Current	$V_{CM} = 2.0\text{V}$		$\pm 1$	$\pm 50$ <b><math>\pm 75</math></b>	nA
		$V_{CM} = 0.5\text{V}$		$\pm 11$	$\pm 60$ <b><math>\pm 80</math></b>	
$TCI_{OS}$	Input Offset Current Drift	$V_{CM} = 0.5\text{V}$ and $V_{CM} = 2.0\text{V}$		0.0474		nA/ $^\circ\text{C}$
CMRR	Common Mode Rejection Ratio	$0.15\text{V} \leq V_{CM} \leq 0.7\text{V}$	101	120		dB
		$0.23\text{V} \leq V_{CM} \leq 0.7\text{V}$	<b>89</b>			
		$1.5\text{V} \leq V_{CM} \leq 2.35\text{V}$	105	129		
		$1.5\text{V} \leq V_{CM} \leq 2.27\text{V}$	<b>99</b>			
PSRR	Power Supply Rejection Ratio	$2.5\text{V} \leq V^+ \leq 5\text{V}$	111 <b>105</b>	129		dB
		$1.8\text{V} \leq V^+ \leq 5.5\text{V}$		117		
CMVR	Common Mode Voltage Range	Large Signal CMRR $\geq 80\text{ dB}$	0		2.5	V
$A_{VOL}$	Open Loop Voltage Gain	$R_L = 10\text{ k}\Omega$ to $V^+/2$	112	130		dB
		$V_{OUT} = 0.5\text{V}$ to $2.0\text{V}$	<b>104</b>			
		$R_L = 2\text{ k}\Omega$ to $V^+/2$	109	119		
		$V_{OUT} = 0.5\text{V}$ to $2.0\text{V}$	<b>90</b>			

Symbol	Parameter	Conditions	Min (Note 6)	Typ (Note 5)	Max (Note 6)	Units
$V_{OUT}$	Output Voltage Swing High	$R_L = 10\text{ k}\Omega$ to $V^+/2$		4	50 <b>75</b>	mV from either rail
		$R_L = 2\text{ k}\Omega$ to $V^+/2$		13	50 <b>75</b>	
	Output Voltage Swing Low	$R_L = 10\text{ k}\Omega$ to $V^+/2$		6	50 <b>75</b>	
		$R_L = 2\text{ k}\Omega$ to $V^+/2$		9	50 <b>75</b>	
$I_{OUT}$	Output Current	Sourcing, $V_{OUT} = V^+/2$ $V_{IN}(\text{diff}) = 100\text{ mV}$	22 <b>12</b>	31		mA
		Sinking, $V_{OUT} = V^+/2$ $V_{IN}(\text{diff}) = -100\text{ mV}$	15 <b>10</b>	44		
$I_S$	Supply Current (Per Channel)	$V_{CM} = 2.0\text{V}$		2.0	2.7 <b>3.4</b>	mA
		$V_{CM} = 0.5\text{V}$		2.3	3.1 <b>3.9</b>	
SR	Slew Rate	$A_V = +1$ , $C_L = 10\text{ pF}$ , $R_L = 10\text{ k}\Omega$ to $V^+/2$ , $V_O = 2 V_{PP}$		2.4		V/ $\mu\text{s}$
GBW	Gain Bandwidth	$C_L = 20\text{ pF}$ , $R_L = 10\text{ k}\Omega$ to $V^+/2$		21		MHz
$G_M$	Gain Margin	$C_L = 20\text{ pF}$ , $R_L = 10\text{ k}\Omega$ to $V^+/2$		14		dB
$\Phi_M$	Phase Margin	$C_L = 20\text{ pF}$ , $R_L = 10\text{ k}\Omega$ to $V^+/2$		60		deg
$R_{IN}$	Input Resistance	Differential Mode		38		k $\Omega$
		Common Mode		151		M $\Omega$
THD+N	Total Harmonic Distortion + Noise	$A_V = 1$ , $f = 1\text{ kHz}$ , Amplitude = 1V		0.002		%
$e_n$	Input Referred Voltage Noise Density	$f = 1\text{ kHz}$ , $V_{CM} = 2.0\text{V}$		3		nV/ $\sqrt{\text{Hz}}$
		$f = 1\text{ kHz}$ , $V_{CM} = 0.5\text{V}$		3		
	Input Voltage Noise	0.1 Hz to 10 Hz		75		nV $_{PP}$
$i_n$	Input Referred Current Noise Density	$f = 1\text{ kHz}$ , $V_{CM} = 2.0\text{V}$		1.1		pA/ $\sqrt{\text{Hz}}$
		$f = 1\text{ kHz}$ , $V_{CM} = 0.5\text{V}$		2.3		

### 3.3V Electrical Characteristics (Note 4)

Unless otherwise specified, all limits are guaranteed for  $T_A = 25^\circ\text{C}$ ,  $V^+ = 3.3\text{V}$ ,  $V^- = 0\text{V}$ ,  $V_{CM} = V^+/2$ ,  $R_L > 10\text{ k}\Omega$  to  $V^+/2$ . **Bold-face** limits apply at the temperature extremes.

Symbol	Parameter	Conditions	Min (Note 6)	Typ (Note 5)	Max (Note 6)	Units
$V_{OS}$	Input Offset Voltage (Note 7)	$V_{CM} = 2.5\text{V}$		$\pm 6$	$\pm 500$ <b><math>\pm 600</math></b>	$\mu\text{V}$
		$V_{CM} = 0.5\text{V}$		$\pm 6$	$\pm 500$ <b><math>\pm 600</math></b>	
$TCV_{OS}$	Input Offset Voltage Temperature Drift	$V_{CM} = 2.5\text{V}$		$\pm 0.5$	$\pm 5.5$	$\mu\text{V}/^\circ\text{C}$
		$V_{CM} = 0.5\text{V}$		$\pm 0.2$	$\pm 5.5$	
$I_B$	Input Bias Current	$V_{CM} = 2.5\text{V}$		$\pm 1.5$	$\pm 30$ <b><math>\pm 45</math></b>	nA
		$V_{CM} = 0.5\text{V}$		$\pm 13$	$\pm 50$ <b><math>\pm 77</math></b>	
$I_{OS}$	Input Offset Current	$V_{CM} = 2.5\text{V}$		$\pm 1$	$\pm 50$ <b><math>\pm 70</math></b>	nA
		$V_{CM} = 0.5\text{V}$		$\pm 11$	$\pm 60$ <b><math>\pm 80</math></b>	

Symbol	Parameter	Conditions	Min (Note 6)	Typ (Note 5)	Max (Note 6)	Units
TCI <sub>OS</sub>	Input Offset Current Drift	$V_{CM} = 0.5V$ and $V_{CM} = 2.5V$		0.048		nA/°C
CMRR	Common Mode Rejection Ratio	$0.15V \leq V_{CM} \leq 0.7V$ $0.23V \leq V_{CM} \leq 0.7V$	101 89	120		dB
		$1.5V \leq V_{CM} \leq 3.15V$ $1.5V \leq V_{CM} \leq 3.07V$	105 99	130		
PSRR	Power Supply Rejection Ratio	$2.5V \leq V^+ \leq 5.0V$	111 105	129		dB
		$1.8V \leq V^+ \leq 5.5V$		117		
CMVR	Common Mode Voltage Range	Large Signal CMRR $\geq 80$ dB	0		3.3	V
A <sub>VOL</sub>	Open Loop Voltage Gain	$R_L = 10\text{ k}\Omega$ to $V^+/2$ $V_{OUT} = 0.5V$ to $2.8V$	112 104	130		dB
		$R_L = 2\text{ k}\Omega$ to $V^+/2$ $V_{OUT} = 0.5V$ to $2.8V$	110 92	119		
V <sub>OUT</sub>	Output Voltage Swing High	$R_L = 10\text{ k}\Omega$ to $V^+/2$		5	50 75	mV from either rail
		$R_L = 2\text{ k}\Omega$ to $V^+/2$		14	50 75	
	Output Voltage Swing Low	$R_L = 10\text{ k}\Omega$ to $V^+/2$		9	50 75	
		$R_L = 2\text{ k}\Omega$ to $V^+/2$		13	50 75	
I <sub>OUT</sub>	Output Current	Sourcing, $V_{OUT} = V^+/2$ $V_{IN}$ (diff) = 100 mV	28 22	45		mA
		Sinking, $V_{OUT} = V^+/2$ $V_{IN}$ (diff) = -100 mV	25 20	48		
I <sub>S</sub>	Supply Current (Per Channel)	$V_{CM} = 2.5V$		2.1	2.8 3.5	mA
		$V_{CM} = 0.5V$		2.4	3.2 4.0	
SR	Slew Rate	$A_V = +1$ , $C_L = 10\text{ pF}$ , $R_L = 10\text{ k}\Omega$ to $V^+/2$ , $V_{OUT} = 2 V_{PP}$		2.4		V/ $\mu$ s
GBW	Gain Bandwidth	$C_L = 20\text{ pF}$ , $R_L = 10\text{ k}\Omega$ to $V^+/2$		22		MHz
G <sub>M</sub>	Gain Margin	$C_L = 20\text{ pF}$ , $R_L = 10\text{ k}\Omega$ to $V^+/2$		14		dB
$\Phi_M$	Phase Margin	$C_L = 20\text{ pF}$ , $R_L = 10\text{ k}\Omega$ to $V^+/2$		62		deg
R <sub>IN</sub>	Input Resistance	Differential Mode		38		k $\Omega$
		Common Mode		151		M $\Omega$
THD+N	Total Harmonic Distortion + Noise	$A_V = 1$ , $f = 1\text{ kHz}$ , Amplitude = 1V,		0.002		%
e <sub>n</sub>	Input Referred Voltage Noise Density	$f = 1\text{ kHz}$ , $V_{CM} = 2.5V$		2.9		nV/ $\sqrt{\text{Hz}}$
		$f = 1\text{ kHz}$ , $V_{CM} = 0.5V$		2.9		
	Input Voltage Noise	0.1 Hz to 10 Hz		65		nV <sub>PP</sub>
i <sub>n</sub>	Input Referred Current Noise Density	$f = 1\text{ kHz}$ , $V_{CM} = 2.5V$		1.1		pA/ $\sqrt{\text{Hz}}$
		$f = 1\text{ kHz}$ , $V_{CM} = 0.5V$		2.1		

## 5V Electrical Characteristics (Note 4)

Unless otherwise specified, all limits are guaranteed for  $T_A = 25^\circ\text{C}$ ,  $V^+ = 5\text{V}$ ,  $V^- = 0\text{V}$ ,  $V_{\text{CM}} = V^+/2$ ,  $R_L > 10\text{ k}\Omega$  to  $V^+/2$ . **Boldface** limits apply at the temperature extremes.

Symbol	Parameter	Conditions	Min (Note 6)	Typ (Note 5)	Max (Note 6)	Units
$V_{\text{OS}}$	Input Offset Voltage (Note 7)	$V_{\text{CM}} = 4.5\text{V}$		$\pm 6$	$\pm 500$ <b><math>\pm 600</math></b>	$\mu\text{V}$
		$V_{\text{CM}} = 0.5\text{V}$		$\pm 6$	$\pm 500$ <b><math>\pm 600</math></b>	
$\text{TCV}_{\text{OS}}$	Input Offset Voltage Temperature Drift	$V_{\text{CM}} = 4.5\text{V}$		$\pm 0.5$	$\pm 5.5$	$\mu\text{V}/^\circ\text{C}$
		$V_{\text{CM}} = 0.5\text{V}$		$\pm 0.2$	$\pm 5.5$	
$I_{\text{B}}$	Input Bias Current	$V_{\text{CM}} = 4.5\text{V}$		$\pm 1.5$	$\pm 30$ <b><math>\pm 50</math></b>	nA
		$V_{\text{CM}} = 0.5\text{V}$		$\pm 14$	$\pm 50$ <b><math>\pm 85</math></b>	
$I_{\text{OS}}$	Input Offset Current	$V_{\text{CM}} = 4.5\text{V}$		$\pm 1$	$\pm 50$ <b><math>\pm 70</math></b>	nA
		$V_{\text{CM}} = 0.5\text{V}$		$\pm 11$	$\pm 65$ <b><math>\pm 80</math></b>	
$\text{TCI}_{\text{OS}}$	Input Offset Current Drift	$V_{\text{CM}} = 0.5\text{V}$ and $V_{\text{CM}} = 4.5\text{V}$		0.0482		$\text{nA}/^\circ\text{C}$
CMRR	Common Mode Rejection Ratio	$0.15\text{V} \leq V_{\text{CM}} \leq 0.7\text{V}$	101	120		dB
		$0.23\text{V} \leq V_{\text{CM}} \leq 0.7\text{V}$	<b>89</b>			
		$1.5\text{V} \leq V_{\text{CM}} \leq 4.85\text{V}$	105	130		
		$1.5\text{V} \leq V_{\text{CM}} \leq 4.77\text{V}$	<b>99</b>			
PSRR	Power Supply Rejection Ratio	$2.5\text{V} \leq V^+ \leq 5\text{V}$	111 <b>105</b>	129		dB
		$1.8\text{V} \leq V^+ \leq 5.5\text{V}$		117		
CMVR	Common Mode Voltage Range	Large Signal CMRR $\geq 80\text{ dB}$	0		5	V
$A_{\text{VOL}}$	Open Loop Voltage Gain	$R_L = 10\text{ k}\Omega$ to $V^+/2$ $V_{\text{OUT}} = 0.5\text{V}$ to $4.5\text{V}$	112 <b>104</b>	130		dB
		$R_L = 2\text{ k}\Omega$ to $V^+/2$ $V_{\text{OUT}} = 0.5\text{V}$ to $4.5\text{V}$	110 <b>94</b>	119		
$V_{\text{OUT}}$	Output Voltage Swing High	$R_L = 10\text{ k}\Omega$ to $V^+/2$		8	50 <b>75</b>	mV from either rail
		$R_L = 2\text{ k}\Omega$ to $V^+/2$		24	50 <b>75</b>	
	Output Voltage Swing Low	$R_L = 10\text{ k}\Omega$ to $V^+/2$		9	50 <b>75</b>	
		$R_L = 2\text{ k}\Omega$ to $V^+/2$		23	50 <b>75</b>	
$I_{\text{OUT}}$	Output Current	Sourcing, $V_{\text{OUT}} = V^+/2$ $V_{\text{IN}}(\text{diff}) = 100\text{ mV}$	33 <b>27</b>	47		mA
		Sinking, $V_{\text{OUT}} = V^+/2$ $V_{\text{IN}}(\text{diff}) = -100\text{ mV}$	30 <b>25</b>	49		
$I_{\text{S}}$	Supply Current (Per Channel)	$V_{\text{CM}} = 4.5\text{V}$		2.2	3.0 <b>3.7</b>	mA
		$V_{\text{CM}} = 0.5\text{V}$		2.5	3.4 <b>4.2</b>	
SR	Slew Rate	$A_V = +1$ , $C_L = 10\text{ pF}$ , $R_L = 10\text{ k}\Omega$ to $V^+/2$ , $V_{\text{OUT}} = 2 V_{\text{PP}}$		2.4		$\text{V}/\mu\text{s}$
GBW	Gain Bandwidth	$C_L = 20\text{ pF}$ , $R_L = 10\text{ k}\Omega$ to $V^+/2$		22		MHz

Symbol	Parameter	Conditions	Min (Note 6)	Typ (Note 5)	Max (Note 6)	Units
$G_M$	Gain Margin	$C_L = 20 \text{ pF}, R_L = 10 \text{ k}\Omega$ to $V^+/2$		12		dB
$\Phi_M$	Phase Margin	$C_L = 20 \text{ pF}, R_L = 10 \text{ k}\Omega$ to $V^+/2$		65		deg
$R_{IN}$	Input Resistance	Differential Mode		38		$\text{k}\Omega$
		Common Mode		151		$\text{M}\Omega$
THD+N	Total Harmonic Distortion + Noise	$A_V = 1, f = 1 \text{ kHz}, \text{Amplitude} = 1\text{V}$		0.001		%
$e_n$	Input Referred Voltage Noise Density	$f = 1 \text{ kHz}, V_{CM} = 4.5\text{V}$		2.9		$\text{nV}/\sqrt{\text{Hz}}$
		$f = 1 \text{ kHz}, V_{CM} = 0.5\text{V}$		2.9		
	Input Voltage Noise	0.1 Hz to 10 Hz		78		$\text{nV}_{PP}$
$i_n$	Input Referred Current Noise Density	$f = 1 \text{ kHz}, V_{CM} = 4.5\text{V}$		1.1		$\text{pA}/\sqrt{\text{Hz}}$
		$f = 1 \text{ kHz}, V_{CM} = 0.5\text{V}$		2.2		

**Note 1:** Absolute Maximum Ratings indicate limits beyond which damage to the device may occur. Operating Ratings indicate conditions for which the device is intended to be functional, but specific performance is not guaranteed. For guaranteed specifications and the test conditions, see the Electrical Characteristics Tables.

**Note 2:** Human Body Model, applicable std. MIL-STD-883, Method 3015.7. Machine Model, applicable std. JESD22-A115-A (ESD MM std. of JEDEC) Field-Induced Charge-Device Model, applicable std. JESD22-C101-C (ESD FICDM std. of JEDEC).

**Note 3:** The maximum power dissipation is a function of  $T_{J(MAX)}$ ,  $\theta_{JA}$ . The maximum allowable power dissipation at any ambient temperature is  $P_D = (T_{J(MAX)} - T_A) / \theta_{JA}$ . All numbers apply for packages soldered directly onto a PC Board.

**Note 4:** Electrical Table values apply only for factory testing conditions at the temperature indicated. Factory testing conditions result in very limited self-heating of the device such that  $T_J = T_A$ . No guarantee of parametric performance is indicated in the electrical tables under conditions of internal self-heating where  $T_J > T_A$ . Absolute maximum Ratings indicate junction temperature limits beyond which the device maybe permanently degraded, either mechanically or electrically.

**Note 5:** Typical values represent the most likely parametric norm as determined at the time of characterization. Actual typical values may vary over time and will also depend on the application and configuration. The typical values are not tested and are not guaranteed on shipped production material.

**Note 6:** All limits are guaranteed by testing, statistical analysis or design.

**Note 7:** Ambient production test is performed at 25°C with a variance of  $\pm 3^\circ\text{C}$ .

### Connection Diagrams

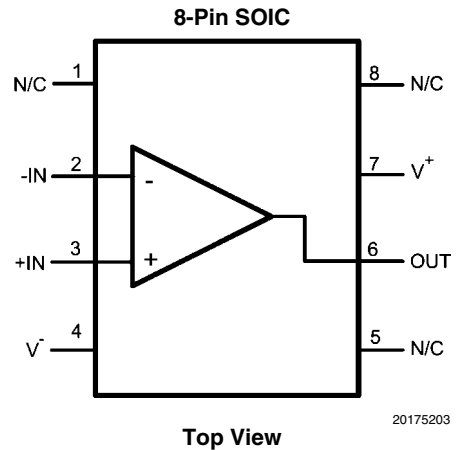
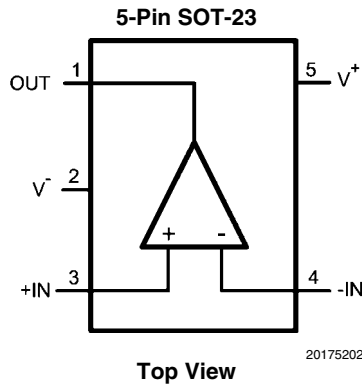

### Ordering Information

Package	Part Number	Package Marking	Transport Media	NSC Drawing
5-Pin SOT-23	LMP7731MF	AY3A	1k Units Tape and Reel	MF05A
	LMP7731MFE		250 Units Tape an Reel	
	LMP7731MFX		3k Units Tape and Reel	
8-Pin SOIC	LMP7731MA	LMP7731MA	95 Units/Rail	M08A
	LMP7731MAX		2.5k Tape and Reel	

# Typical Performance Characteristics

Unless otherwise noted:  $T_A = 25^\circ\text{C}$ ,  $R_L > 10\text{ k}\Omega$ ,  $V_{CM} = V_S/2$ .

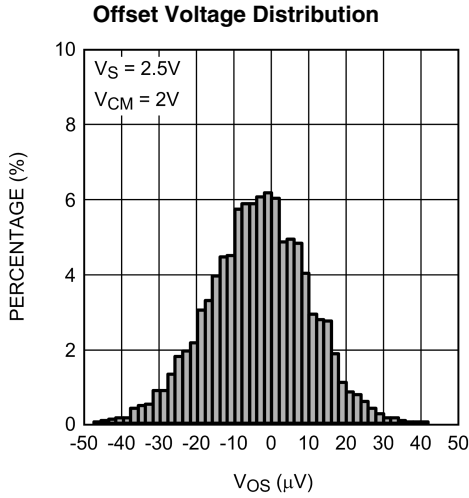

20175238

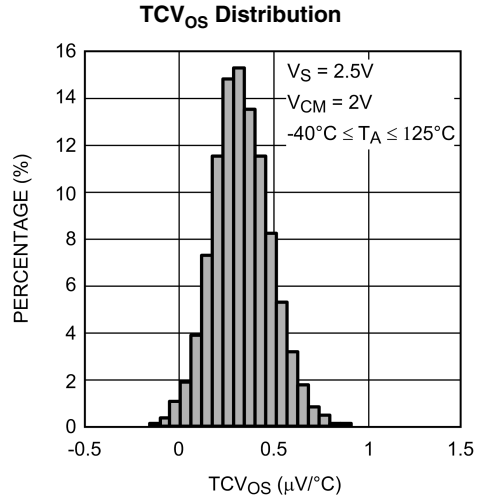

20175234

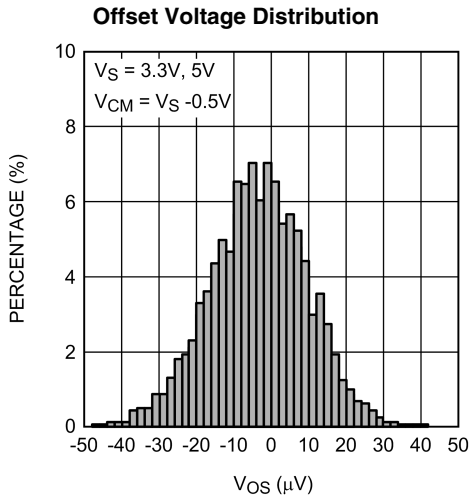

20175239

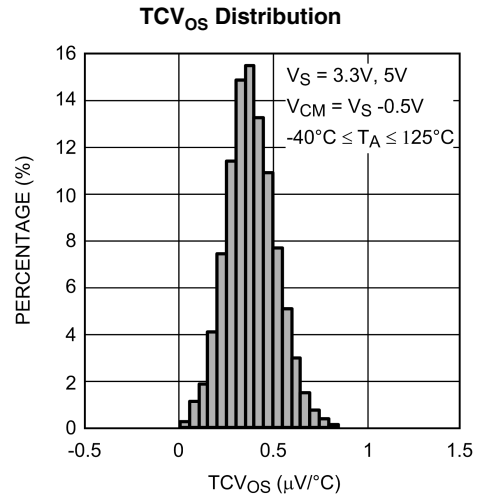

20175236

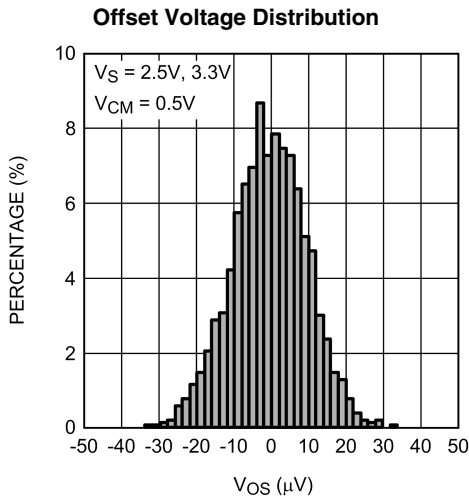

20175240

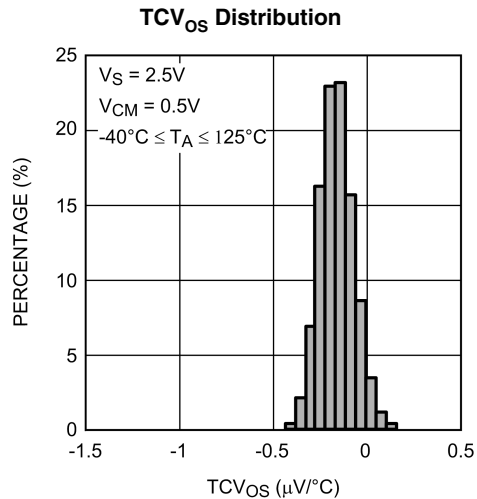

20175235

Offset Voltage Distribution

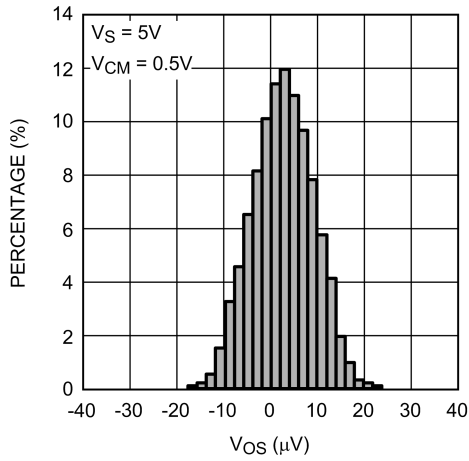

20175241

TCV<sub>OS</sub> Distribution

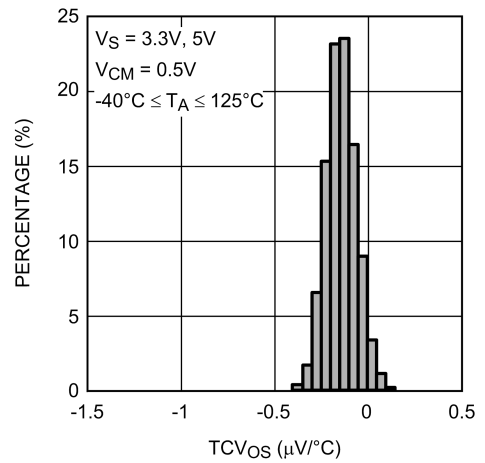

20175237

Offset Voltage vs. Temperature

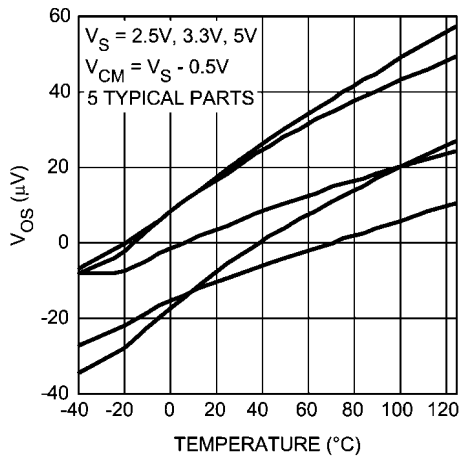

20175251

Offset Voltage vs. Temperature

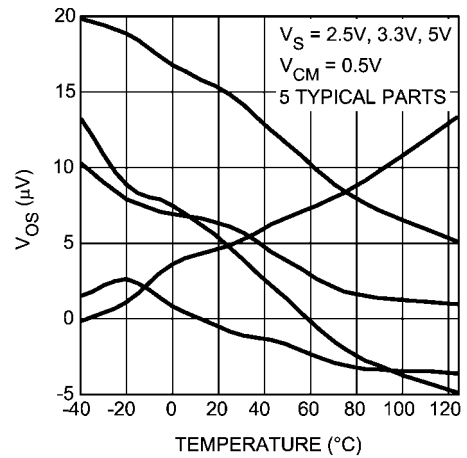

20175252

PSRR vs. Frequency

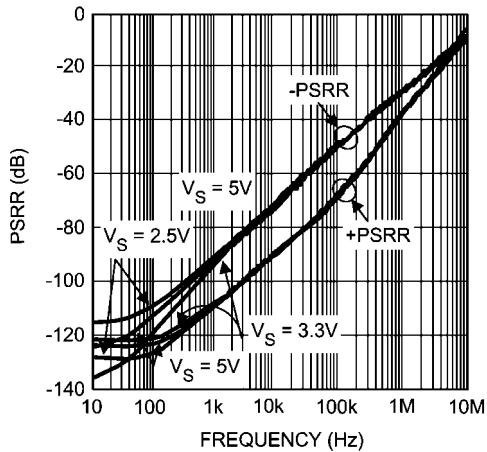

20175229

CMRR vs. Frequency

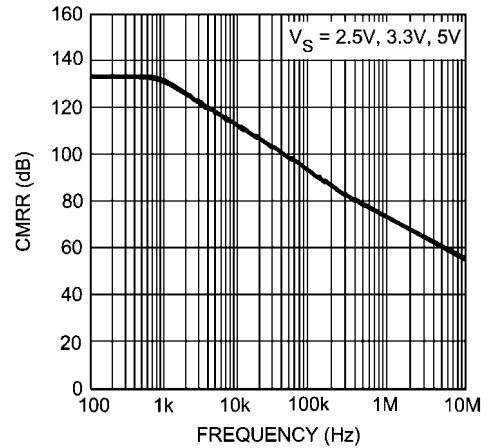

20175256



Offset Voltage vs. Supply Voltage

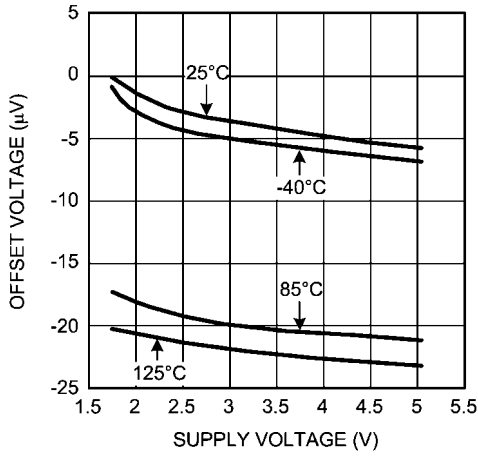

20175242

Offset Voltage vs.  $V_{CM}$

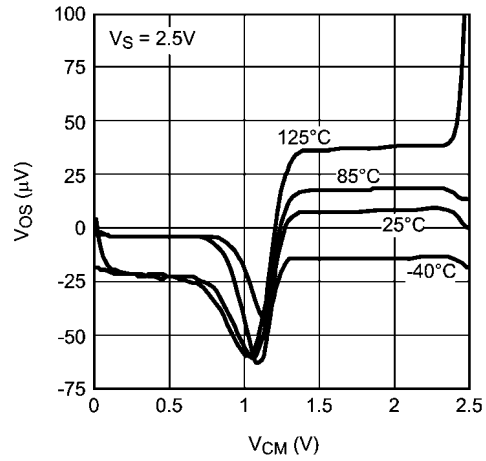

20175243

Offset Voltage vs.  $V_{CM}$

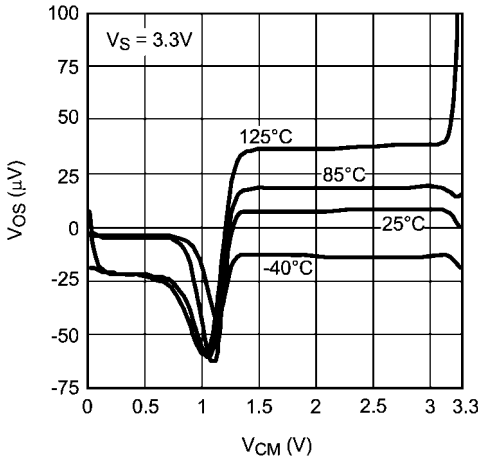

20175244

Offset Voltage vs.  $V_{CM}$

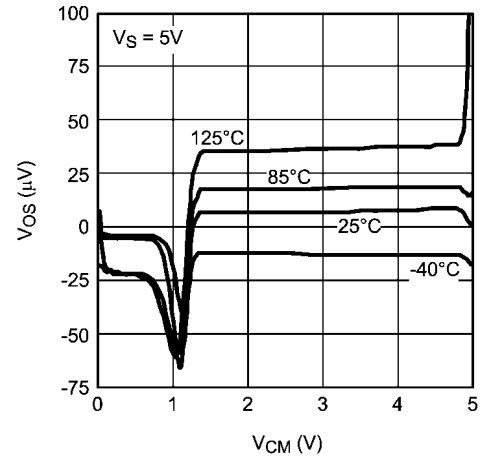

20175245

Input Offset Voltage Time Drift

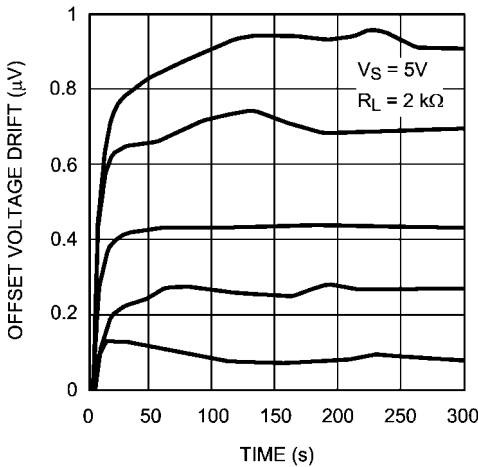

20175230

Slew Rate vs. Supply Voltage

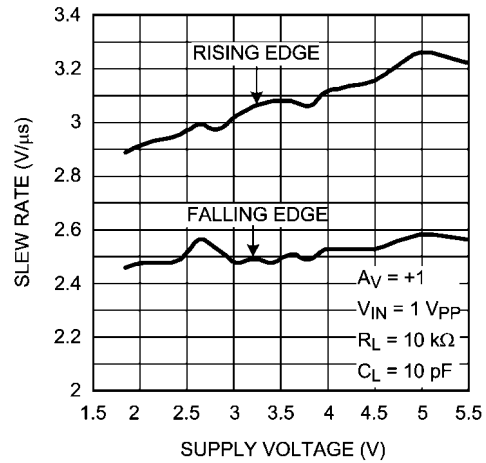

20175220

Time Domain Voltage Noise

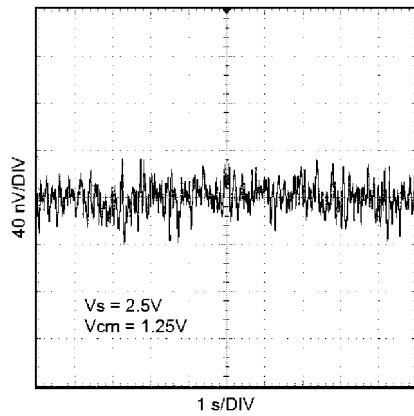

20175269

Time Domain Voltage Noise

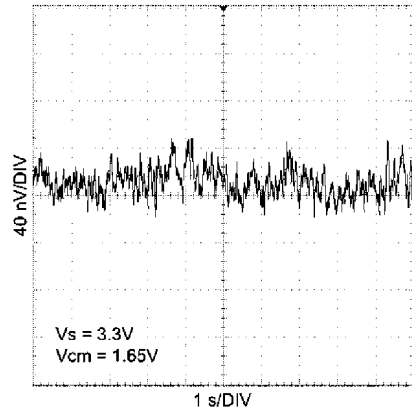

20175267

Time Domain Voltage Noise

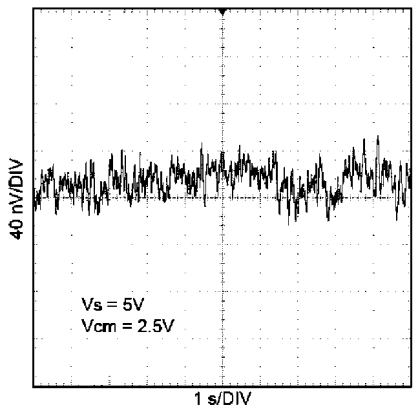

20175268

Output Voltage vs. Output Current

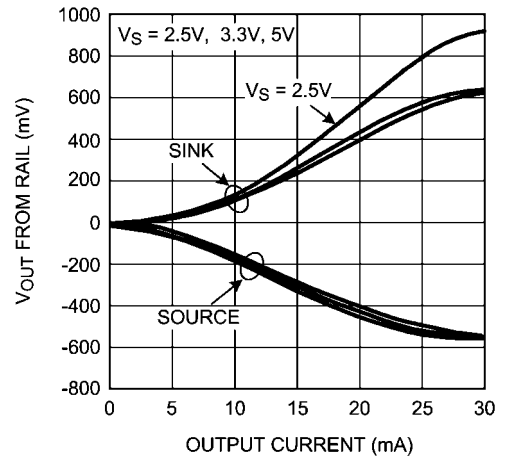

20175259

Input Bias Current vs.  $V_{CM}$

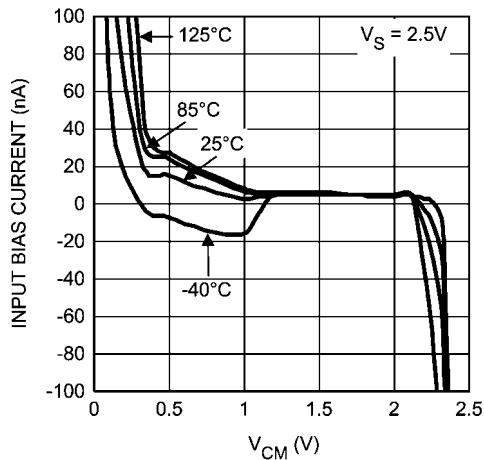

20175225

Input Bias Current vs.  $V_{CM}$

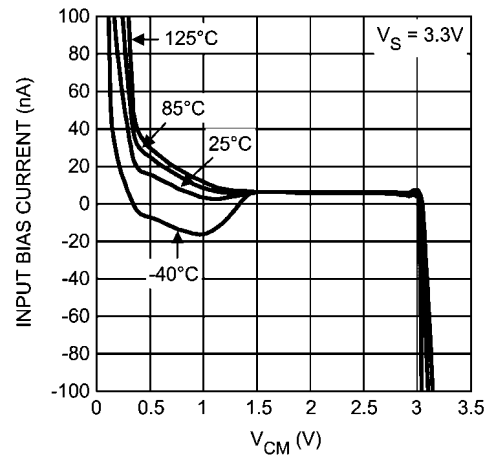

20175226

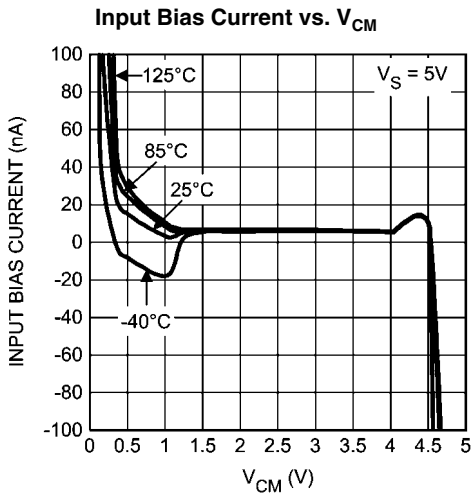

20175227

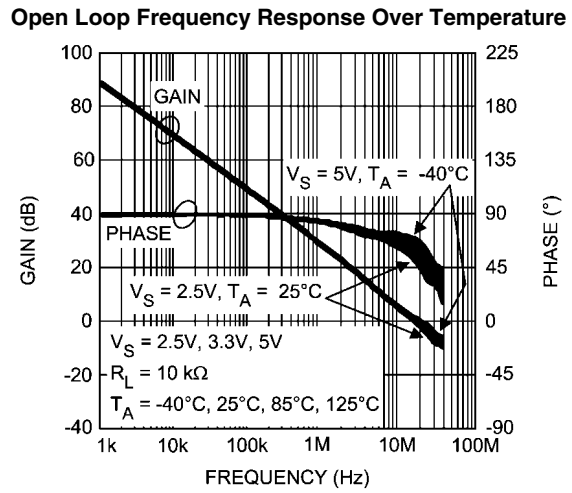

20175218

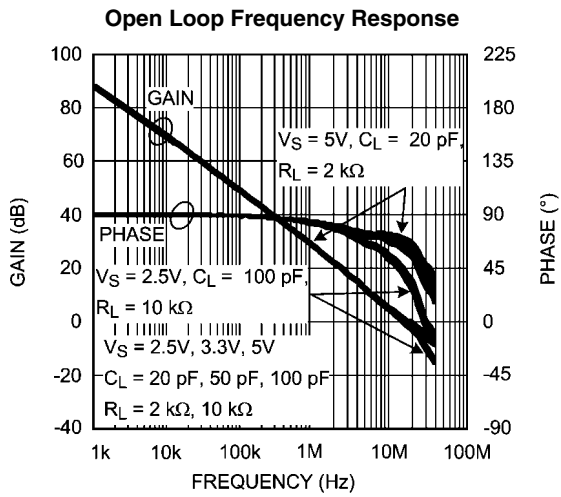

20175219

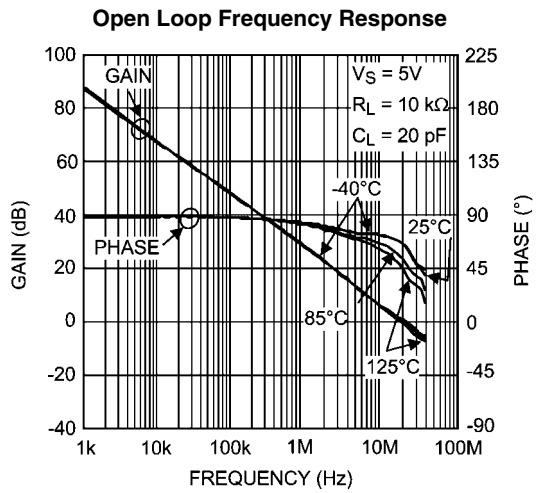

20175228

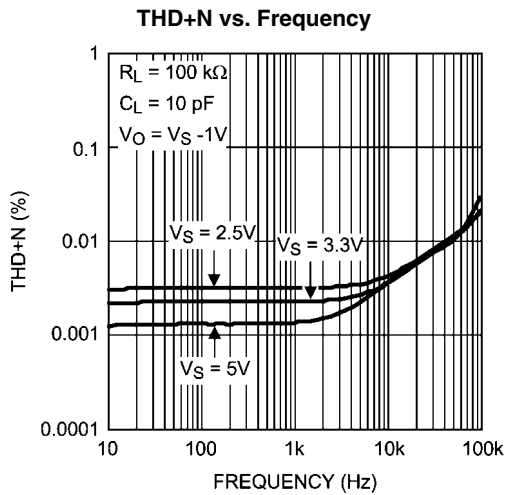

20175257

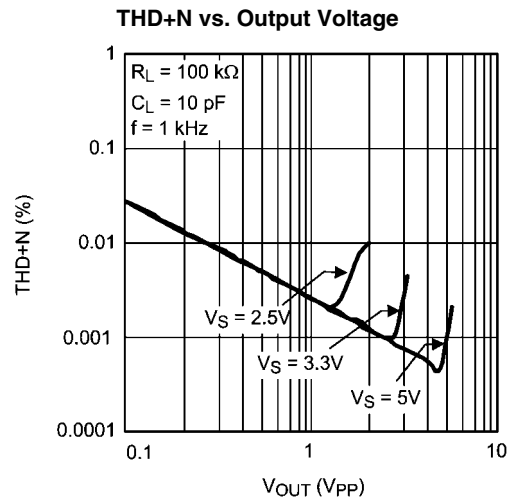

20175258

Large Signal Step Response

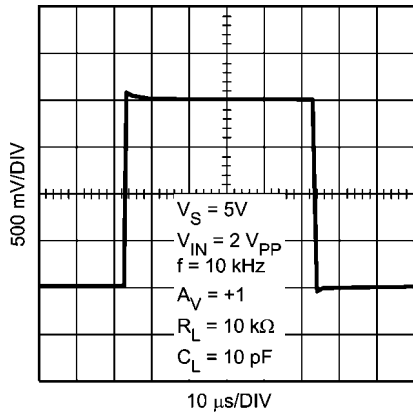

20175222

Small Signal Step Response

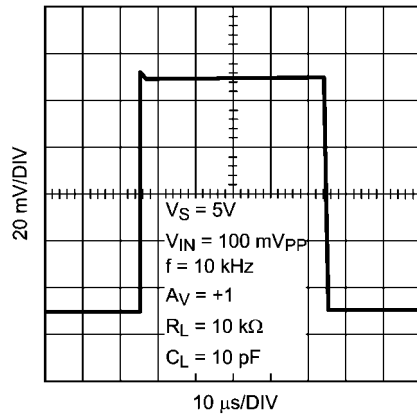

20175221

Large Signal Step Response

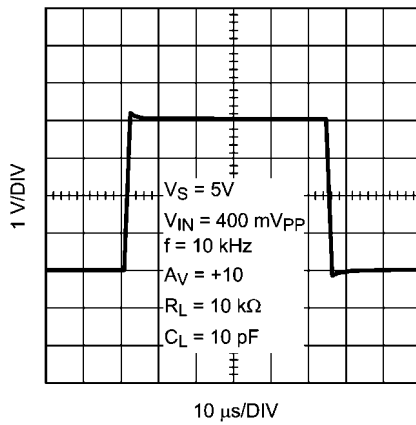

20175224

Small Signal Step Response

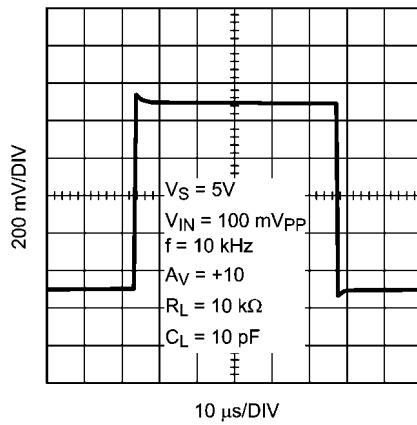

20175223

Supply Current vs. Supply Voltage

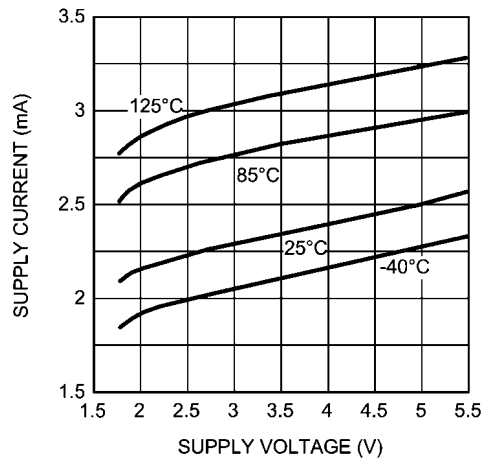

20175246

Output Swing High vs. Supply Voltage

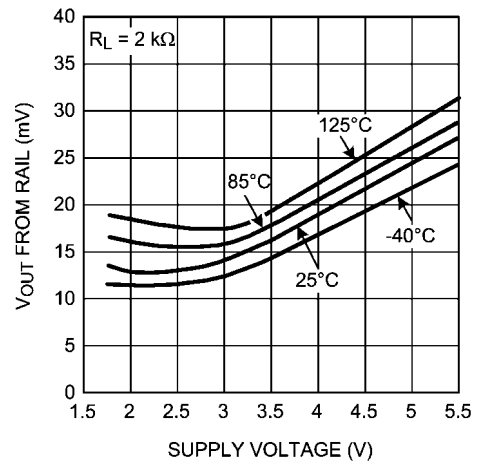

20175250

**Output Swing Low vs. Supply Voltage**

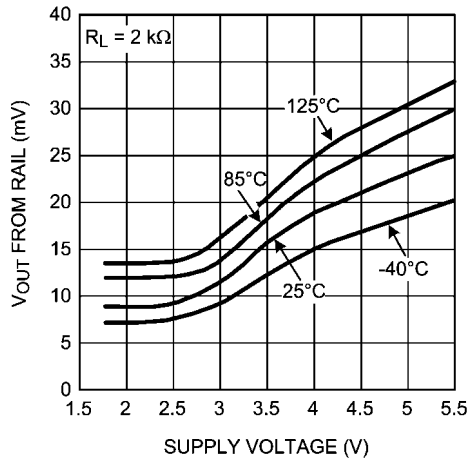

20175249

**Sinking Current vs. Supply Voltage**

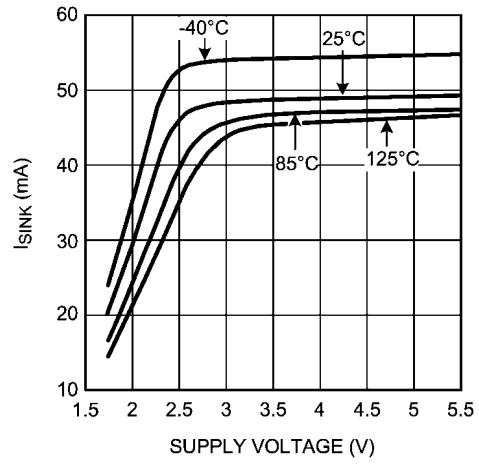

20175247

**Sourcing Current vs. Supply Voltage**

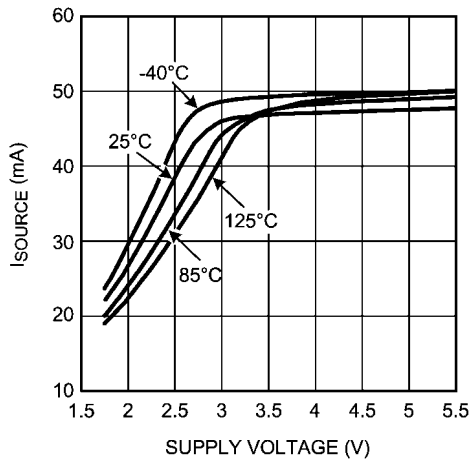

20175248

## Application Information

### LMP7731

The LMP7731 is a single, low noise, rail-to-rail input and output, and low voltage amplifier.

The low input voltage noise of only 2.9 nV/ $\sqrt{\text{Hz}}$  with a 1/f corner at 3 Hz makes the LMP7731 ideal for sensor applications where DC accuracy is of importance.

The LMP7731 has a high gain bandwidth of 22 MHz. This wide bandwidth enables use of the amplifier at higher gain settings while retaining usable bandwidth for the application. This is particularly beneficial when system designers need to use sensors with very limited output voltage range as it allows larger gains in one stage which in turn increases the signal to noise ratio.

The LMP7731 has proprietary input bias cancellation circuitry on the input stages. This allows the LMP7731 to have only about 1.5 nA bias current with a bipolar input stage. This low input bias current, paired with the inherent lower input voltage noise of bipolar input stages makes the LMP7731 an excellent choice for precision applications. The combination of low input bias current, and low input voltage noise enables the user to achieve unprecedented accuracy and higher signal integrity.

National Semiconductor is heavily committed to precision amplifiers and the market segment they serve. Technical support and extensive characterization data are available for sensitive applications or applications with a constrained error budget.

The LMP7731 is offered in the space saving 5-Pin SOT-23 and 8-Pin SOIC packages. These small packages are ideal solutions for area constrained PC boards and portable electronics.

### INPUT BIAS CURRENT CANCELLATION

The LMP7731 has proprietary input bias current cancellation circuitry on their input stages.

The LMP7731 has rail-to-rail input. This is achieved by having two input stages in parallel. *Figure 1* shows only one of the input stages as the circuitry is symmetrical for both stages.

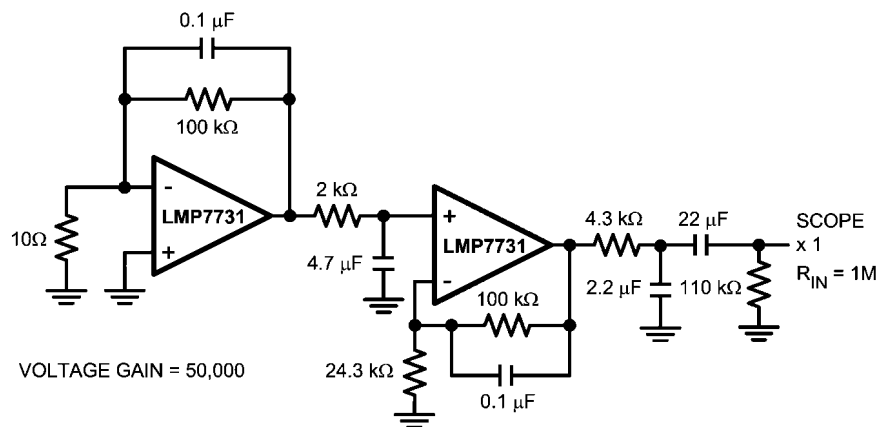
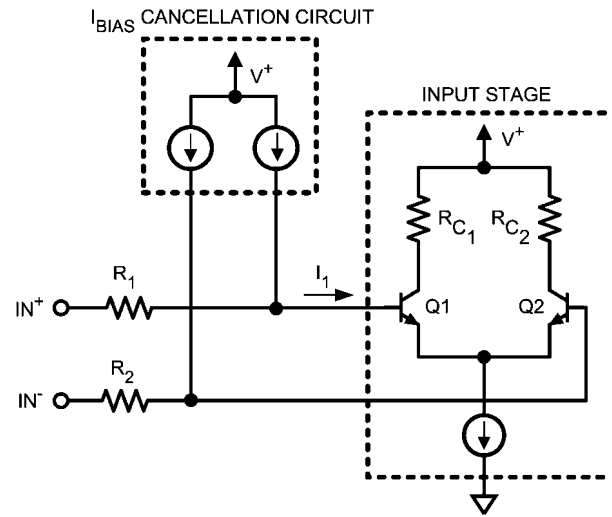

FIGURE 2. 0.1 Hz to 10 Hz Noise Test Circuit

The frequency response of this noise test circuit at the 0.1 Hz corner is defined by only one zero. The test time for the 0.1 Hz to 10 Hz noise measurement using this configuration should not exceed 10 seconds, as this time limit acts as an

*Figure 1* shows that as the common mode voltage gets closer to one of the extreme ends, current  $I_1$  significantly increases. This increased current shows as an increase in voltage drop across resistor  $R_1$  equal to  $I_1 \cdot R_1$  on  $\text{IN}^+$  of the amplifier. This voltage contributes to the offset voltage of the amplifier. When common mode voltage is in the mid-range, the transistors are operating in the linear region and  $I_1$  is significantly small. The voltage drop due to  $I_1$  across  $R_1$  can be ignored as it is orders of magnitude smaller than the amplifier's input offset voltage. As the common mode voltage gets closer to one of the rails, the offset voltage generated due to  $I_1$  increases and becomes comparable to the amplifiers offset voltage.



20175206

FIGURE 1. Input Bias Current Cancellation

### INPUT VOLTAGE NOISE MEASUREMENT

The LMP7731 has very low input voltage noise. The peak-to-peak input voltage noise of the LMP7731 can be measured using the test circuit shown in *Figure 2*

additional zero to reduce or eliminate the noise contributions of noise from frequencies below 0.1 Hz.

*Figure 3* shows typical peak-to-peak noise for the LMP7731 measured with the circuit in *Figure 2* for the LMP7731.

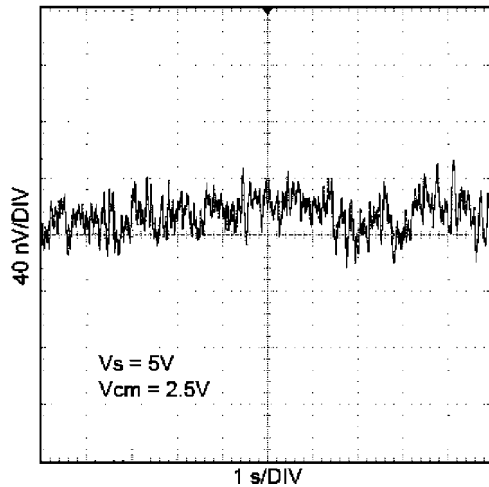

20175268

**FIGURE 3. 0.1 Hz to 10 Hz Input Voltage Noise**

Measuring the very low peak-to-peak noise performance of the LMP7731, requires special testing attention. In order to achieve accurate results, the device should be warmed up for at least five minutes. This is so that the input offset voltage of the op amp settles to a value. During this warm up period, the offset can typically change by a few  $\mu\text{V}$  because the chip temperature increases by about  $30^\circ\text{C}$ . If the 10 seconds of the measurement is selected to include this warm up time, some of this temperature change might show up as the measured noise. *Figure 4* shows the start-up drift of five typical LMP7731 units.

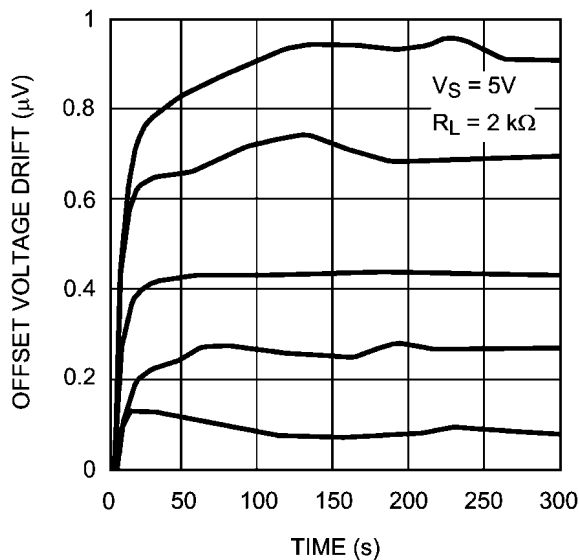

20175230

**FIGURE 4. Start-Up Input Offset Voltage Drift**

During the peak-to-peak noise measurement, the LMP7731 must be shielded. This prevents offset variations due to airflow. Offset can vary by a few nV due to this airflow and that can invalidate measurements of input voltage noise with a magnitude which is in the same range. For similar reasons, sudden motions must also be restricted in the vicinity of the test area. The feed-through which results from this motion could increase the observed noise value which in turn would invalidate the measurement.

#### DIODES BETWEEN THE INPUTS

The LMP7731 has a set of anti-parallel diodes between the input pins as shown in *Figure 5*. These diodes are present to protect the input stage of the amplifier. At the same time, they limit the amount of differential input voltage that is allowed on the input pins. A differential signal larger than the voltage needed to turn on the diodes might cause damage to the diodes. The differential voltage between the input pins should be limited to  $\pm 3$  diode drops or the input current needs to be limited to  $\pm 20$  mA.

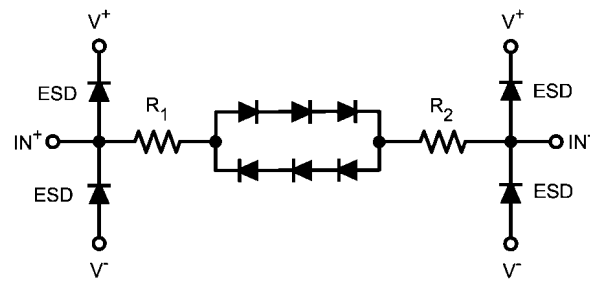

20175204

**FIGURE 5. Anti-Parallel Diodes between Inputs**

### DRIVING AN ADC

Analog to Digital Converters, ADCs, usually have a sampling capacitor on their input. When the ADC's input is directly connected to the output of the amplifier a charging current flows from the amplifier to the ADC. This charging current causes a momentary glitch that can take some time to settle. There are different ways to minimize this effect. One way is to slow down the sampling rate. This method gives the amplifier sufficient time to stabilize its output. Another way to minimize the glitch caused by the switch capacitor is to have an external capacitor connected to the input of the ADC. This capacitor is chosen so that its value is much larger than the internal switching capacitor and it will hence provide the voltage needed to quickly and smoothly charge the ADC's sampling capacitor. Since this large capacitor will be loading the output of the amplifier as well, an isolation resistor is needed between the output of the amplifier and this capacitor. The isolation resistor,  $R_{ISO}$ , separates the additional load capacitance from the output of the amplifier and will also form a low-pass filter and can be designed to provide noise reduction as well as anti-aliasing. The drawback to having  $R_{ISO}$  is that it reduces signal swing since there is some voltage drop across it.

*Figure 6 (a)* shows the ADC directly connected to the amplifier. To minimize the glitch in this setting, a slower sample rate needs to be used. *Figure 6 (b)* shows  $R_{ISO}$  and an external capacitor used to minimize the glitch.

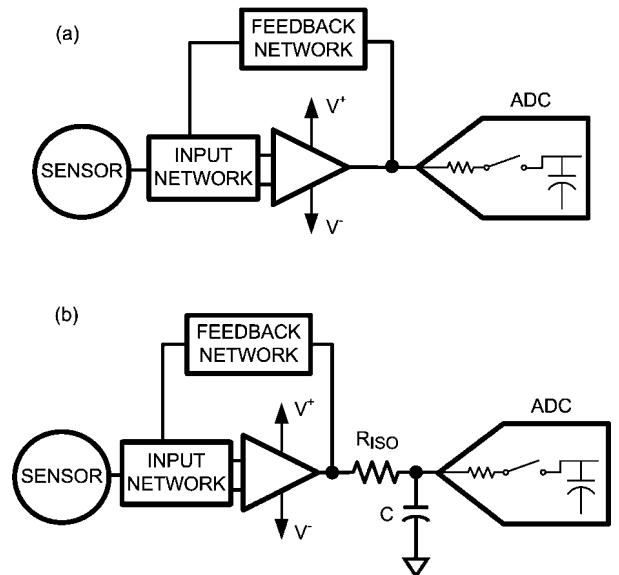

20175205

**FIGURE 6. Driving an ADC**



**Physical Dimensions** inches (millimeters) unless otherwise noted

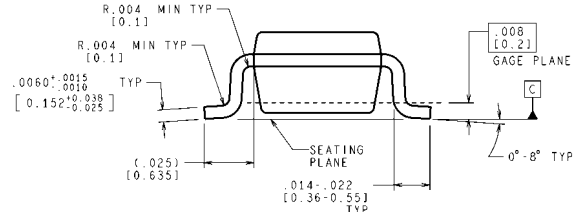
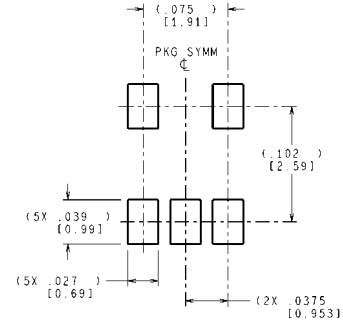
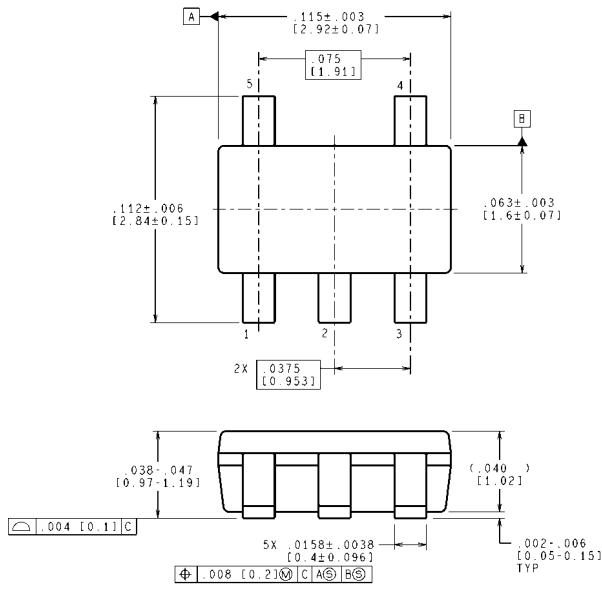

CONTROLLING DIMENSION IS INCH  
VALUES IN [ ] ARE MILLIMETERS  
DIMENSIONS IN ( ) FOR REFERENCE ONLY

MF05A (Rev D)

**5-Pin SOT-23**  
**NS Package Number MF05A**

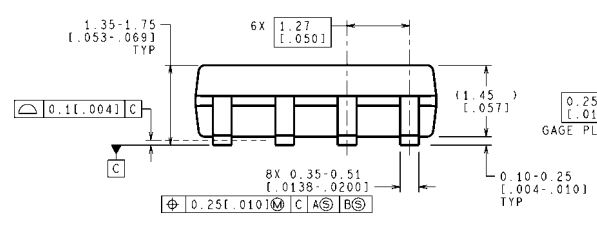
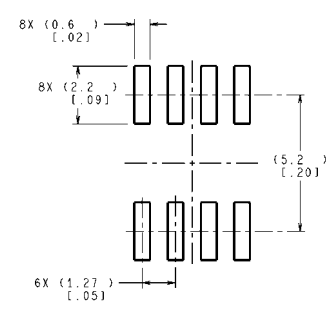
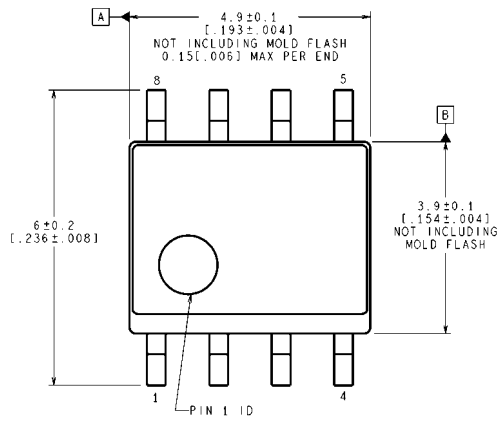

CONTROLLING DIMENSION IS MILLIMETER  
VALUES IN [ ] ARE INCHES  
DIMENSIONS IN ( ) FOR REFERENCE ONLY

M08A (Rev L)

**8-Pin SOIC**  
**NS Package Number M08A**

## Notes

For more National Semiconductor product information and proven design tools, visit the following Web sites at:

Products		Design Support	
Amplifiers	<a href="http://www.national.com/amplifiers">www.national.com/amplifiers</a>	WEBENCH® Tools	<a href="http://www.national.com/webench">www.national.com/webench</a>
Audio	<a href="http://www.national.com/audio">www.national.com/audio</a>	App Notes	<a href="http://www.national.com/appnotes">www.national.com/appnotes</a>
Clock and Timing	<a href="http://www.national.com/timing">www.national.com/timing</a>	Reference Designs	<a href="http://www.national.com/refdesigns">www.national.com/refdesigns</a>
Data Converters	<a href="http://www.national.com/adc">www.national.com/adc</a>	Samples	<a href="http://www.national.com/samples">www.national.com/samples</a>
Interface	<a href="http://www.national.com/interface">www.national.com/interface</a>	Eval Boards	<a href="http://www.national.com/evalboards">www.national.com/evalboards</a>
LVDS	<a href="http://www.national.com/lvds">www.national.com/lvds</a>	Packaging	<a href="http://www.national.com/packaging">www.national.com/packaging</a>
Power Management	<a href="http://www.national.com/power">www.national.com/power</a>	Green Compliance	<a href="http://www.national.com/quality/green">www.national.com/quality/green</a>
Switching Regulators	<a href="http://www.national.com/switchers">www.national.com/switchers</a>	Distributors	<a href="http://www.national.com/contacts">www.national.com/contacts</a>
LDOs	<a href="http://www.national.com/ldo">www.national.com/ldo</a>	Quality and Reliability	<a href="http://www.national.com/quality">www.national.com/quality</a>
LED Lighting	<a href="http://www.national.com/led">www.national.com/led</a>	Feedback/Support	<a href="http://www.national.com/feedback">www.national.com/feedback</a>
Voltage Reference	<a href="http://www.national.com/vref">www.national.com/vref</a>	Design Made Easy	<a href="http://www.national.com/easy">www.national.com/easy</a>
PowerWise® Solutions	<a href="http://www.national.com/powerwise">www.national.com/powerwise</a>	Solutions	<a href="http://www.national.com/solutions">www.national.com/solutions</a>
Serial Digital Interface (SDI)	<a href="http://www.national.com/sdi">www.national.com/sdi</a>	Mil/Aero	<a href="http://www.national.com/milaero">www.national.com/milaero</a>
Temperature Sensors	<a href="http://www.national.com/tempensors">www.national.com/tempensors</a>	SolarMagic™	<a href="http://www.national.com/solarmagic">www.national.com/solarmagic</a>
Wireless (PLL/VCO)	<a href="http://www.national.com/wireless">www.national.com/wireless</a>	PowerWise® Design University	<a href="http://www.national.com/training">www.national.com/training</a>

THE CONTENTS OF THIS DOCUMENT ARE PROVIDED IN CONNECTION WITH NATIONAL SEMICONDUCTOR CORPORATION ("NATIONAL") PRODUCTS. NATIONAL MAKES NO REPRESENTATIONS OR WARRANTIES WITH RESPECT TO THE ACCURACY OR COMPLETENESS OF THE CONTENTS OF THIS PUBLICATION AND RESERVES THE RIGHT TO MAKE CHANGES TO SPECIFICATIONS AND PRODUCT DESCRIPTIONS AT ANY TIME WITHOUT NOTICE. NO LICENSE, WHETHER EXPRESS, IMPLIED, ARISING BY ESTOPPEL OR OTHERWISE, TO ANY INTELLECTUAL PROPERTY RIGHTS IS GRANTED BY THIS DOCUMENT.

TESTING AND OTHER QUALITY CONTROLS ARE USED TO THE EXTENT NATIONAL DEEMS NECESSARY TO SUPPORT NATIONAL'S PRODUCT WARRANTY. EXCEPT WHERE MANDATED BY GOVERNMENT REQUIREMENTS, TESTING OF ALL PARAMETERS OF EACH PRODUCT IS NOT NECESSARILY PERFORMED. NATIONAL ASSUMES NO LIABILITY FOR APPLICATIONS ASSISTANCE OR BUYER PRODUCT DESIGN. BUYERS ARE RESPONSIBLE FOR THEIR PRODUCTS AND APPLICATIONS USING NATIONAL COMPONENTS. PRIOR TO USING OR DISTRIBUTING ANY PRODUCTS THAT INCLUDE NATIONAL COMPONENTS, BUYERS SHOULD PROVIDE ADEQUATE DESIGN, TESTING AND OPERATING SAFEGUARDS.

EXCEPT AS PROVIDED IN NATIONAL'S TERMS AND CONDITIONS OF SALE FOR SUCH PRODUCTS, NATIONAL ASSUMES NO LIABILITY WHATSOEVER, AND NATIONAL DISCLAIMS ANY EXPRESS OR IMPLIED WARRANTY RELATING TO THE SALE AND/OR USE OF NATIONAL PRODUCTS INCLUDING LIABILITY OR WARRANTIES RELATING TO FITNESS FOR A PARTICULAR PURPOSE, MERCHANTABILITY, OR INFRINGEMENT OF ANY PATENT, COPYRIGHT OR OTHER INTELLECTUAL PROPERTY RIGHT.

### LIFE SUPPORT POLICY

**NATIONAL'S PRODUCTS ARE NOT AUTHORIZED FOR USE AS CRITICAL COMPONENTS IN LIFE SUPPORT DEVICES OR SYSTEMS WITHOUT THE EXPRESS PRIOR WRITTEN APPROVAL OF THE CHIEF EXECUTIVE OFFICER AND GENERAL COUNSEL OF NATIONAL SEMICONDUCTOR CORPORATION.** As used herein:

Life support devices or systems are devices which (a) are intended for surgical implant into the body, or (b) support or sustain life and whose failure to perform when properly used in accordance with instructions for use provided in the labeling can be reasonably expected to result in a significant injury to the user. A critical component is any component in a life support device or system whose failure to perform can be reasonably expected to cause the failure of the life support device or system or to affect its safety or effectiveness.

National Semiconductor and the National Semiconductor logo are registered trademarks of National Semiconductor Corporation. All other brand or product names may be trademarks or registered trademarks of their respective holders.

Copyright© 2009 National Semiconductor Corporation

For the most current product information visit us at [www.national.com](http://www.national.com)



**National Semiconductor Americas Technical Support Center**  
 Email: [support@nsc.com](mailto:support@nsc.com)  
 Tel: 1-800-272-9959

**National Semiconductor Europe Technical Support Center**  
 Email: [europe.support@nsc.com](mailto:europe.support@nsc.com)

**National Semiconductor Asia Pacific Technical Support Center**  
 Email: [ap.support@nsc.com](mailto:ap.support@nsc.com)

**National Semiconductor Japan Technical Support Center**  
 Email: [jpn.feedback@nsc.com](mailto:jpn.feedback@nsc.com)