

TOSHIBA CMOS Digital Integrated Circuit Silicon Monolithic

TC7SA34F, TC7SA34FU

Non-Inverter with 3.6 V Tolerant Input and Output

Features

- Low voltage operation : $V_{CC} = 1.8\sim 3.6\text{ V}$
- High speed operation : $t_{pd} = 2.8\text{ ns (max) (}V_{CC} = 3.0\sim 3.6\text{ V)}$
 : $t_{pd} = 3.7\text{ ns (max) (}V_{CC} = 2.3\sim 2.7\text{ V)}$
 : $t_{pd} = 7.4\text{ ns (max) (}V_{CC} = 1.8\text{ V)}$
- High Output current : $I_{OH}/I_{OL} = \pm 24\text{ mA (min) (}V_{CC} = 3.0\text{ V)}$
 : $I_{OH}/I_{OL} = \pm 18\text{ mA (min) (}V_{CC} = 2.3\text{ V)}$
 : $I_{OH}/I_{OL} = \pm 6\text{ mA (min) (}V_{CC} = 1.8\text{ V)}$
- Latch-up performance: $\pm 300\text{ mA}$ or more
- ESD performance : Human body model $> \pm 200\text{ V}$
 : Machine model $> \pm 2000\text{ V}$
- Power down protection is provided on all inputs and outputs.

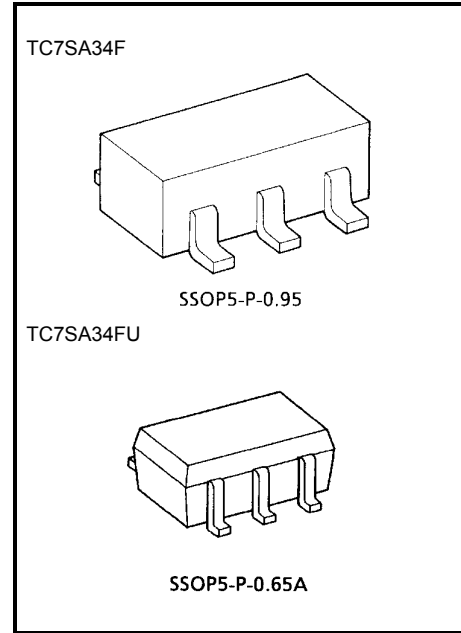

Weight
 SSOP5-P-0.95 : 0.016 g (typ.)
 SSOP5-P-0.65A : 0.006 g (typ.)

Maximum Ratings (Ta = 25°C)

Characteristics	Symbol	Rating	Unit
Power supply voltage	V_{CC}	-0.5~4.6	V
DC input voltage	V_{IN}	-0.5~4.6	V
DC output voltage	V_{OUT}	-0.5~4.6 (Note 1)	V
		-0.5~ $V_{CC} + 0.5$ (Note 2)	
Input diode current	I_{IK}	-50	mA
Output diode current	I_{OK}	± 50 (Note 3)	mA
DC output current	I_{OUT}	± 50	mA
Power dissipation	P_D	200	mW
DC V_{CC} /ground current	I_{CC}	± 100	mA
Storage temperature range	T_{stg}	-65~150	°C

Note 1: $V_{CC} = 0\text{ V}$

Note 2: High or low state. I_{OUT} absolute maximum rating be observed.

Note 3: $V_{OUT} < GND, V_{OUT} > V_{CC}$

Marking

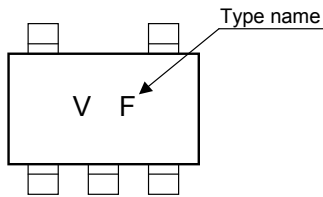

Pin Assignment (top view)

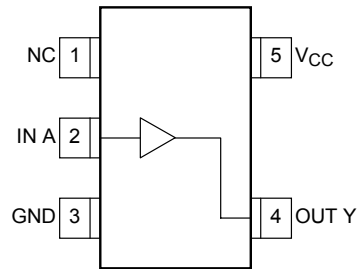

Logic Diagram



Truth Table

A	Y
L	L
H	H

Recommended Operating Range

Characteristics	Symbol	Rating	Unit
Power supply voltage	V_{CC}	1.8~3.6	V
		1.2~3.6 (Note 4)	
Input voltage	V_{IN}	-0.3~3.6	V
Output voltage	V_{OUT}	0~3.6 (Note 5)	V
		0~ V_{CC} (Note 6)	
Output current	I_{OH}/I_{OL}	± 24 (Note 7)	mA
		± 18 (Note 8)	
		± 6 (Note 9)	
Operating temperature range	T_{opr}	-40~85	$^{\circ}C$
Input rise and fall time	dt/dv	0~10 (Note 10)	ns/V

Note 4: Data retention only

Note 5: $V_{CC} = 0$ V

Note 6: High or low state

Note 7: $V_{CC} = 3.0\sim 3.6$ V

Note 8: $V_{CC} = 2.3\sim 2.7$ V

Note 9: $V_{CC} = 1.8$ V

Note 10: $V_{IN} = 0.8\sim 2.0$ V, $V_{CC} = 3.0$ V

Electrical Characteristics

DC Characteristics (Ta = -40~85°C, 2.7 V < V_{CC} ≤ 3.6 V)

Characteristics		Symbol	Test Condition	V _{CC} (V)	Min	Max	Unit
Input voltage	High level	V _{IH}	—	2.7~3.6	2.0	—	V
	Low level	V _{IL}	—	2.7~3.6	—	0.8	
Output voltage	High level	V _{OH}	V _{IN} = V _{IH}	I _{OH} = -100 μA	2.7~3.6	V _{CC} - 0.2	V
				I _{OH} = -12 mA	2.7	2.2	
				I _{OH} = -18 mA	3.0	2.4	
				I _{OH} = -24 mA	3.0	2.2	
	Low level	V _{OL}	V _{IN} = V _{IL}	I _{OL} = 100 μA	2.7~3.6	—	0.2
				I _{OL} = 12 mA	2.7	—	0.4
				I _{OL} = 18 mA	3.0	—	0.4
				I _{OL} = 24 mA	3.0	—	0.55
Input leakage current		I _{IN}	V _{IN} = 0~3.6 V	2.7~3.6	—	±5.0	μA
Power off leakage current		I _{OFF}	V _{IN} , V _{OUT} = 0~3.6 V	0	—	10.0	μA
Quiescent supply current		I _{CC}	V _{IN} = V _{CC} or GND	2.7~3.6	—	20.0	μA
			V _{CC} ≤ (V _{IN} , V _{OUT}) ≤ 3.6 V	2.7~3.6	—	±20.0	
Increase in I _{CC} per input		ΔI _{CC}	V _{IH} = V _{CC} - 0.6 V	2.7~3.6	—	750	

DC Characteristics (Ta = -40~85°C, 2.3 V ≤ V_{CC} ≤ 2.7 V)

Characteristics		Symbol	Test Condition	V _{CC} (V)	Min	Max	Unit
Input voltage	High level	V _{IH}	—	2.3~2.7	1.6	—	V
	Low level	V _{IL}	—	2.3~2.7	—	0.7	
Output voltage	High level	V _{OH}	V _{IN} = V _{IH}	I _{OH} = -100 μA	2.3~2.7	V _{CC} - 0.2	V
				I _{OH} = -6 mA	2.3	2.0	
				I _{OH} = -12 mA	2.3	1.8	
				I _{OH} = -18 mA	2.3	1.7	
	Low level	V _{OL}	V _{IN} = V _{IL}	I _{OL} = 100 μA	2.3~2.7	—	0.2
				I _{OL} = 12 mA	2.3	—	0.4
				I _{OL} = 18 mA	2.3	—	0.6
Input leakage current		I _{IN}	V _{IN} = 0~3.6 V	2.3~2.7	—	±5.0	μA
Power off leakage current		I _{OFF}	V _{IN} , V _{OUT} = 0~3.6 V	0	—	10.0	μA
Quiescent supply current		I _{CC}	V _{IN} = V _{CC} or GND	2.3~2.7	—	20.0	μA
			V _{CC} ≤ (V _{IN} , V _{OUT}) ≤ 3.6 V	2.3~2.7	—	±20.0	

DC Characteristics (Ta = -40~85°C, 1.8 V ≤ VCC < 2.3 V)

Characteristics		Symbol	Test Condition		VCC (V)	Min	Max	Unit
Input voltage	High level	V _{IH}	—		1.8~2.3	0.7 × V _{CC}	—	V
	Low level	V _{IL}	—		1.8~2.3	—	0.2 × V _{CC}	
Output voltage	High level	V _{OH}	V _{IN} = V _{IH}	I _{OH} = -100 μA	1.8	V _{CC} - 0.2	—	V
				I _{OH} = -6 mA	1.8	1.4	—	
	Low level	V _{OL}	V _{IN} = V _{IL}	I _{OL} = 100 μA	1.8	—	0.2	
				I _{OL} = 6 mA	1.8	—	0.3	
Input leakage current		I _{IN}	V _{IN} = 0~3.6 V		1.8	—	±5.0	μA
Power off leakage current		I _{OFF}	V _{IN} , V _{OUT} = 0~3.6 V		0	—	10.0	μA
Quiescent supply current		I _{CC}	V _{IN} = V _{CC} or GND		1.8	—	20.0	μA
			V _{CC} ≤ (V _{IN} , V _{OUT}) ≤ 3.6 V		1.8	—	±20.0	

AC Characteristics (Ta = -40~85°C, input: t_r = t_f = 2.0 ns, C_L = 30 pF, R_L = 500 Ω)

Characteristics		Symbol	Test Condition		VCC (V)	Min	Max	Unit
Propagation delay time	t _{pLH} t _{pHL}	Figure 1, Figure 2			1.8	1.0	7.4	ns
					2.5 ± 0.2	0.8	3.7	
					3.3 ± 0.3	0.6	2.8	

For C_L = 50 pF, add approximately 300 ps to the AC maximum specification.

Dynamic Switching Characteristics (Ta = 25°C, input: tr = tf = 2.0 ns, CL = 30 pF)

Characteristics	Symbol	Test Condition	VCC (V)	Typ.	Unit
Quiet output maximum dynamic VOL	VOLP	VIN = 1.8 V, VIL = 0 V (Note 11)	1.8	0.25	ns
		VIN = 2.5 V, VIL = 0 V (Note 11)	2.5	0.6	
		VIN = 3.3 V, VIL = 0 V (Note 11)	3.3	0.8	
Quiet output minimum dynamic VOL	VOLV	VIN = 1.8 V, VIL = 0 V (Note 11)	1.8	-0.25	ns
		VIN = 2.5 V, VIL = 0 V (Note 11)	2.5	-0.6	
		VIN = 3.3 V, VIL = 0 V (Note 11)	3.3	-0.8	
Quiet output minimum dynamic VOH	VOLP	VIN = 1.8 V, VIL = 0 V (Note 11)	1.8	1.5	ns
		VIN = 2.5 V, VIL = 0 V (Note 11)	2.5	1.9	
		VIN = 3.3 V, VIL = 0 V (Note 11)	3.3	2.2	

Note 11: Parameter guaranteed by design.

Capacitive Characteristics (Ta = 25°C)

Characteristics	Symbol	Test Condition	VCC (V)	Typ.	Unit
Input capacitance	CIN	—	1.8, 2.5, 3.3		pF
Power dissipation capacitance	CPD	fIN = 10 MHz (Note 12)	1.8, 2.5, 3.3		pF

Note 12: CPD is defined as the value of the internal equivalent capacitance which is calculated from the operating current consumption without load.

Average operating current can be obtained by the equation.

$$I_{CC (opr.)} = C_{PD} \cdot V_{CC} \cdot f_{IN} + I_{CC}$$

AC Test Circuit

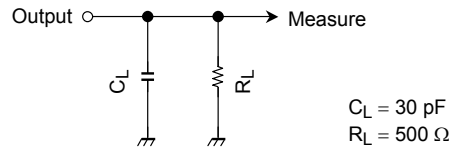
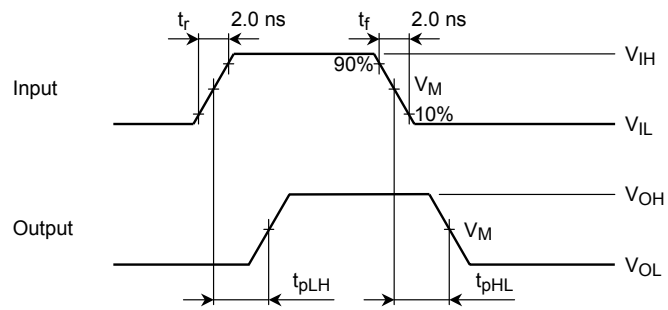

Figure 1

AC Waveform



Symbol	V_{CC}		
	3.3 ± 0.3 V	2.5 ± 0.2 V	1.8 V
V_{IH}	2.7 V	V_{CC}	V_{CC}
V_M	1.5 V	$V_{CC}/2$	$V_{CC}/2$

Figure 2 t_{pLH} , t_{pHL}

Package Dimensions

SSOP5-P-0.95

Unit : mm

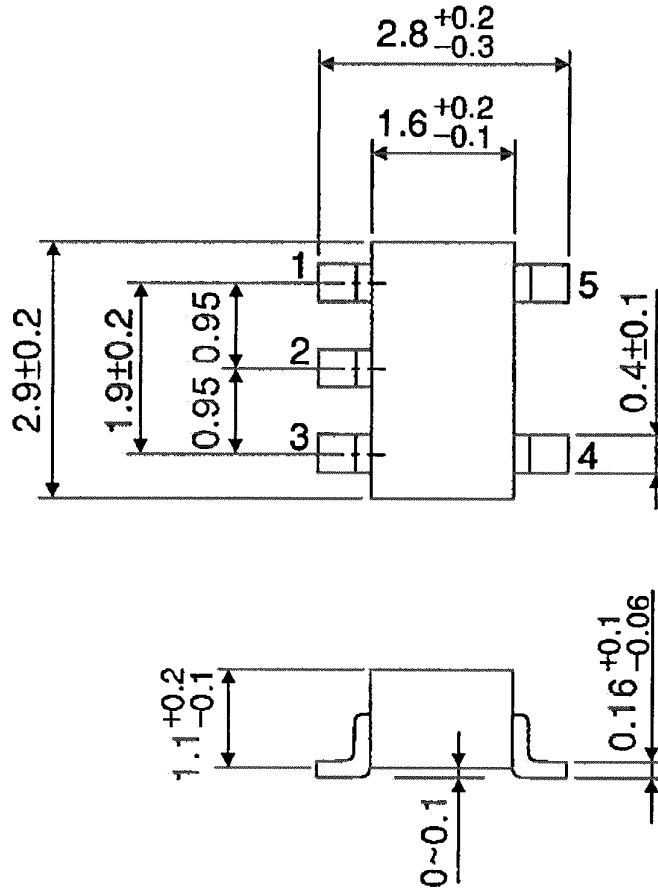

Weight: 0.016 g (typ.)

Package Dimensions

SSOP5-P-0.65A

Unit : mm

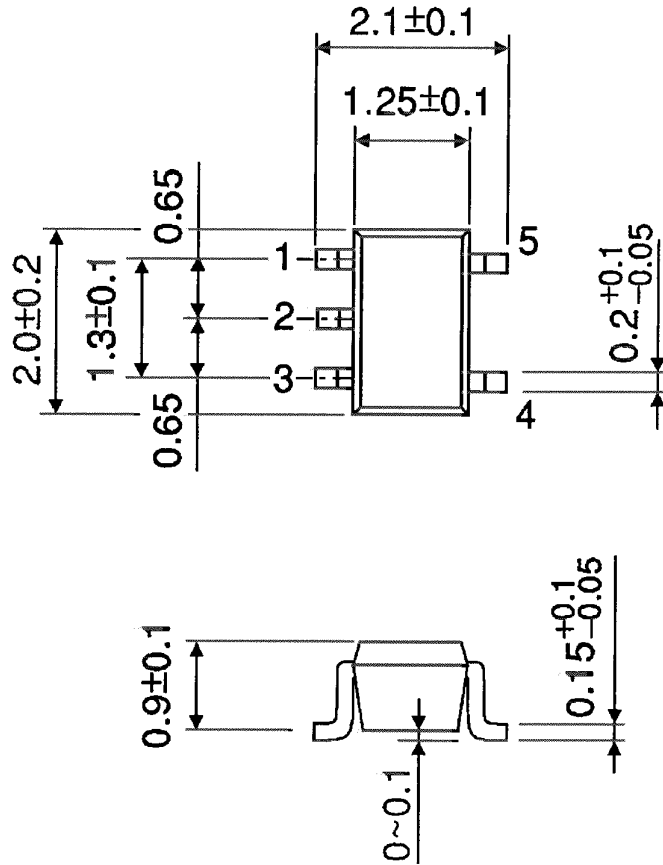

Weight: 0.006 g (typ.)

RESTRICTIONS ON PRODUCT USE

000707EBA

- TOSHIBA is continually working to improve the quality and reliability of its products. Nevertheless, semiconductor devices in general can malfunction or fail due to their inherent electrical sensitivity and vulnerability to physical stress. It is the responsibility of the buyer, when utilizing TOSHIBA products, to comply with the standards of safety in making a safe design for the entire system, and to avoid situations in which a malfunction or failure of such TOSHIBA products could cause loss of human life, bodily injury or damage to property.
In developing your designs, please ensure that TOSHIBA products are used within specified operating ranges as set forth in the most recent TOSHIBA products specifications. Also, please keep in mind the precautions and conditions set forth in the "Handling Guide for Semiconductor Devices," or "TOSHIBA Semiconductor Reliability Handbook" etc..
- The TOSHIBA products listed in this document are intended for usage in general electronics applications (computer, personal equipment, office equipment, measuring equipment, industrial robotics, domestic appliances, etc.). These TOSHIBA products are neither intended nor warranted for usage in equipment that requires extraordinarily high quality and/or reliability or a malfunction or failure of which may cause loss of human life or bodily injury ("Unintended Usage"). Unintended Usage include atomic energy control instruments, airplane or spaceship instruments, transportation instruments, traffic signal instruments, combustion control instruments, medical instruments, all types of safety devices, etc.. Unintended Usage of TOSHIBA products listed in this document shall be made at the customer's own risk.
- The products described in this document are subject to the foreign exchange and foreign trade laws.
- The information contained herein is presented only as a guide for the applications of our products. No responsibility is assumed by TOSHIBA CORPORATION for any infringements of intellectual property or other rights of the third parties which may result from its use. No license is granted by implication or otherwise under any intellectual property or other rights of TOSHIBA CORPORATION or others.
- The information contained herein is subject to change without notice.