



Voltage Output PROGRAMMABLE SENSOR CONDITIONER

FEATURES

- COMPLETE BRIDGE SENSOR CONDITIONER
- VOLTAGE OUTPUT: Ratiometric or Absolute
- DIGITAL CAL: No Potentiometers/Sensor Trims
- SENSOR ERROR COMPENSATION
 - Span, Offset, and Temperature Drifts
- LOW ERROR, TIME-STABLE
- SENSOR LINEARIZATION CIRCUITRY
- TEMPERATURE SENSE: Internal or External
- CALIBRATION LOOKUP TABLE LOGIC
 - Uses External EEPROM (SOT23-5)
- OVER/UNDER-SCALE LIMITING
- SENSOR FAULT DETECTION
- +2.7V TO +5.5V OPERATION
- -40°C to +125°C OPERATION
- SMALL TSSOP-16 PACKAGE

APPLICATIONS

- BRIDGE SENSORS
- REMOTE 4-20mA TRANSMITTERS
- STRAIN, LOAD, AND WEIGH SCALES
- AUTOMOTIVE SENSORS

EVALUATION TOOLS

- HARDWARE DESIGNER'S KIT (PGA309EVM)
 - Temperature Eval of PGA309 + Sensor
 - Full Programming of PGA309
 - Sensor Compensation Analysis Tool

DESCRIPTION

The PGA309 is a programmable analog signal conditioner designed for bridge sensors. The analog signal path amplifies the sensor signal and provides digital calibration for zero, span, zero drift, span drift, and sensor linearization errors with applied stress (pressure, strain, etc.). The calibration is done via a One-Wire digital serial interface or through a Two-Wire industry-standard connection. The calibration parameters are stored in external nonvolatile memory (typically SOT23-5) to eliminate manual trimming and achieve long-term stability.

The all-analog signal path contains a 2x2 input multiplexer (mux), auto-zero programmable-gain instrumentation amplifier, linearization circuit, voltage reference, internal oscillator, control logic, and an output amplifier. Programmable level shifting compensates for sensor DC offsets.

The core of the PGA309 is the precision, low-drift, no 1/f noise Front-End PGA (Programmable Gain Amplifier). The overall gain of the Front-End PGA + Output Amplifier can be adjusted from 2.7V/V to 1152V/V. The polarity of the inputs can be switched through the input mux to accommodate sensors with unknown polarity output. The Fault Monitor circuit detects and signals sensor burnout, overload, and system fault conditions.

For detailed application information, see the PGA309 User's Guide (SBOU024), available for download at www.ti.com.

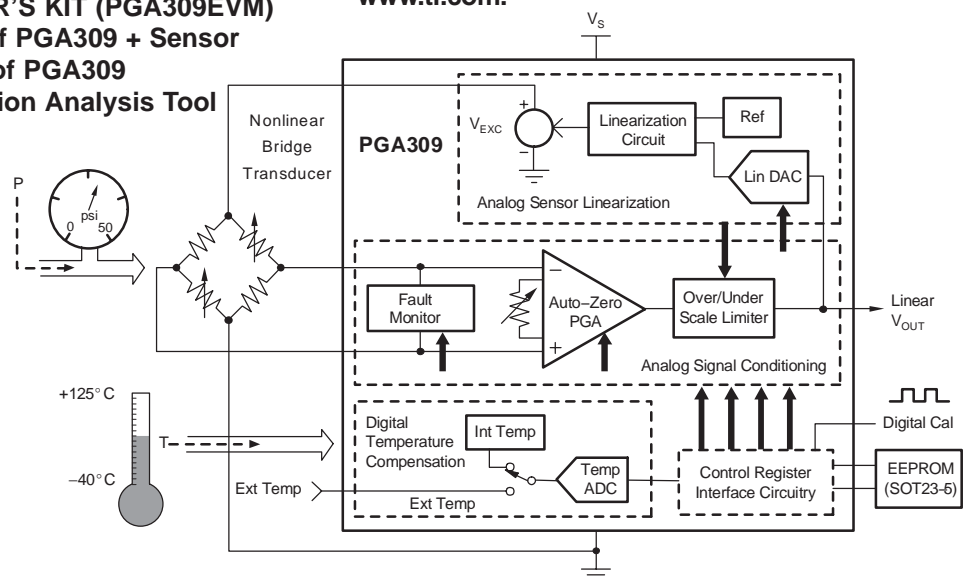

Please be aware that an important notice concerning availability, standard warranty, and use in critical applications of Texas Instruments semiconductor products and disclaimers thereto appears at the end of this data sheet.

All trademarks are the property of their respective owners.

PRODUCTION DATA information is current as of publication date. Products conform to specifications per the terms of Texas Instruments standard warranty. Production processing does not necessarily include testing of all parameters.



Copyright © 2003–2005, Texas Instruments Incorporated

PACKAGE/ORDERING INFORMATION(1)

PRODUCT	PACKAGE-LEAD	PACKAGE DRAWING	SPECIFIED TEMPERATURE RANGE	PACKAGE MARKING	ORDERING NUMBER	TRANSPORT MEDIA, QUANTITY
PGA309	TSSOP-16	PW	-40°C to +125°C	PGA309	PGA309AIPWR	Tape and Reel, 2500
					PGA309AIPWT	Tape and Reel, 250

(1) For the most current package and ordering information, see the Package Option Addendum located at the end of this data sheet, or see the TI website at www.ti.com.

ABSOLUTE MAXIMUM RATINGS(1)

Over operating free-air temperature range unless otherwise noted.

Supply Voltage, V_{SD} , V_{SD}	+7.0V
Input Voltage, V_{IN1} , V_{IN2} (2)	-0.3V to V_{SA} +0.3V
Input Current, V_{FB} , V_{OUT}	±150mA
Input Current	±10mA
Output Current Limit	50mA
Storage Temperature Range	-60°C to +150°C
Operating Temperature Range	-55°C to +150°C
Junction Temperature	+150°C
Lead Temperature (soldering, 10s)	+300°C
ESD Protection (Human Body Model)	4kV

(1) Stresses above these ratings may cause permanent damage. Exposure to absolute maximum conditions for extended periods may degrade device reliability. These are stress ratings only, and functional operation of the device at these or any other conditions beyond those specified is not implied.

(2) Input terminals are diode-clamped to the power-supply rails. Input signals that can swing more than 0.5V beyond the supply rails should be current limited to 10mA or less.



This integrated circuit can be damaged by ESD. Texas Instruments recommends that all integrated circuits be handled with appropriate precautions. Failure to observe proper handling and installation procedures can cause damage.

ESD damage can range from subtle performance degradation to complete device failure. Precision integrated circuits may be more susceptible to damage because very small parametric changes could cause the device not to meet its published specifications.

ELECTRICAL CHARACTERISTICS

BOLDFACE limits apply over the specified temperature range: $T_A = -40^{\circ}\text{C}$ to $+125^{\circ}\text{C}$

$T_A = +25^{\circ}\text{C}$, $V_{SA} = V_{SD} = +5\text{V}$ ($V_{SA} = V_{\text{SUPPLY ANALOG}}$, $V_{SD} = V_{\text{SUPPLY DIGITAL}}$; V_{SA} must equal V_{SD}), $G_{ND_D} = G_{ND_A} = 0$, and $V_{REF} = V_{REF_{IN}}/V_{REF_{OUT}} = +5\text{V}$, unless otherwise noted.

PARAMETER	CONDITIONS	PGA309			UNITS
		MIN	TYP	MAX	
FRONT-END PGA + OUTPUT AMPLIFIER V_{OUT}/V_{IN} Differential Signal Gain Range ⁽¹⁾	Fine Gain Adjust = 1 Front-End PGA Gains: 4, 8, 16, 23.27, 32, 42.67, 64, 128 Output Amplifier Gains: 2, 2.4, 3, 3.6, 4.5, 6, 9 f = 1kHz		8 to 1152		V/V
Input Voltage Noise Density			210		nV/ $\sqrt{\text{Hz}}$
V_{OUT} Slew Rate			0.5		V/ μs
V_{OUT} Settling Time (0.01%)	V_{OUT}/V_{IN} Differential Gain = 8, $R_L = 5\text{k}\Omega \parallel 200\text{pF}$		6		μs
V_{OUT} Settling Time (0.01%)	V_{OUT}/V_{IN} Differential Gain = 191, $R_L = 5\text{k}\Omega \parallel 200\text{pF}$		4.1		μs
V_{OUT} Nonlinearity			0.002		%FSR
External Sensor Output Sensitivity	$V_{SA} = V_{SD} = V_{EXC} = +5\text{V}$		1 to 245		mV/V
FRONT-END PGA					
Auto-Zero Internal Frequency			7		kHz
Offset Voltage (RTI) ⁽²⁾ vs Temperature vs Supply Voltage, V_{SA} vs Common-Mode Voltage	Coarse Offset Adjust Disabled		± 3 ± 0.2 ± 2	± 50	μV $\mu\text{V}/^{\circ}\text{C}$ $\mu\text{V}/\text{V}$
Linear Input Voltage Range⁽³⁾	$G_F = \text{Front-End PGA Gain}$	0.2	1500/ G_F	6000/ G_F $V_{SA} - 1.5$	$\mu\text{V}/\text{V}$ V
Input Bias Current			0.1	1.5	nA
Input Impedance: Differential			30 \parallel 6		$\text{G}\Omega \parallel \text{pF}$
Input Impedance: Common-Mode			50 \parallel 20		$\text{G}\Omega \parallel \text{pF}$
Input Voltage Noise	0.1Hz to 10Hz, $G_F = 128$		4		μV_{pp}
PGA Gain					
Gain Range Steps	4, 8, 16, 23.27, 32, 42.67, 64, 128		4 to 128		V/V
Initial Gain Error	$G_F = 4$ to 42 $G_F = 64$ $G_F = 128$		0.2 0.25 0.3 10	± 1 ± 1.2 ± 1.6	% % %
vs Temperature					ppm/ $^{\circ}\text{C}$
Output Voltage Range			0.05 to $V_{SA} - 0.1$		V
Bandwidth	Gain = 4 Gain = 128		400 60		kHz kHz
COARSE OFFSET ADJUST (RTI OF FRONT-END PGA)					
Range vs Temperature	$\pm(14)(V_{REF})(0.00085)$	± 56	± 59.5 0.004	± 64	mV %/ $^{\circ}\text{C}$
Resolution	± 14 steps, 4-Bit + Sign		4		mV
FINE OFFSET ADJUST (ZERO DAC) (RTO of the Front-End PGA)⁽²⁾					
Programming Range		0		V_{REF}	V
Output Range		0.1		$V_{SA} - 0.1$	V
Resolution	65,536 steps, 16-Bit DAC		73		μV
Integral Nonlinearity			20		LSB
Differential Nonlinearity			0.5		LSB
Gain Error			0.1		%
Gain Error Drift			10		ppm/ $^{\circ}\text{C}$
Offset			5		mV
Offset Drift			10		$\mu\text{V}/^{\circ}\text{C}$
OUTPUT FINE GAIN ADJUST (GAIN DAC)					
Range			0.33 to 1		V/V
Resolution	65,536 steps, 16-Bit DAC		10		$\mu\text{V}/\text{V}$
Integral Nonlinearity			20		LSB
Differential Nonlinearity			0.5		LSB

ELECTRICAL CHARACTERISTICS (continued)

BOLDFACE limits apply over the specified temperature range: $T_A = -40^{\circ}\text{C}$ to $+125^{\circ}\text{C}$

$T_A = +25^{\circ}\text{C}$, $V_{SA} = V_{SD} = +5\text{V}$ ($V_{SA} = V_{\text{SUPPLY ANALOG}}$, $V_{SD} = V_{\text{SUPPLY DIGITAL}}$; V_{SA} must equal V_{SD}), $\text{GND}_D = \text{GND}_A = 0$, and $V_{REF} = \text{REF}_{IN}/\text{REF}_{OUT} = +5\text{V}$, unless otherwise noted.

PARAMETER	CONDITIONS	PGA309			UNITS
		MIN	TYP	MAX	
OUTPUT AMPLIFIER					
Offset Voltage (RTI of Output Amplifier) ⁽²⁾			3		mV
vs Temperature			5		$\mu\text{V}/^{\circ}\text{C}$
vs Supply Voltage, V_{SA}			30		$\mu\text{V}/\text{V}$
Common-Mode Input Range		0		$V_{SA}-1.5$	V
Input Bias Current			100		pA
Amplifier Internal Gain					
Gain Range Steps	2, 2.4, 3, 3.6, 4.5, 6, 9		2 to 9		V/V
Initial Gain Error	2, 2.4, 3.6		0.25	± 1	%
	4.5		0.3	± 1.2	%
	6		0.4	± 1.5	%
	9		0.6	± 2.0	%
vs Temperature	2, 2.4, 3.6		5		$\text{ppm}/^{\circ}\text{C}$
	4.5		5		$\text{ppm}/^{\circ}\text{C}$
	6		15		$\text{ppm}/^{\circ}\text{C}$
	9		30		$\text{ppm}/^{\circ}\text{C}$
Output Voltage Range⁽⁴⁾	$R_L = 10\text{k}\Omega$	0.1		4.9	V
Open Loop Gain			115		dB
Gain-Bandwidth Product			2		MHz
Phase Margin	Gain = 2, $C_L = 200\text{pF}$		45		Degrees
Output Resistance	AC Small-Signal, Open-Loop, $f = 1\text{MHz}$, $I_O = 0$		675		Ω
OVER- AND UNDER-SCALE LIMITS	($V_{REF} = 4.096$)				
Over-Scale Thresholds	Ratio of V_{REF} , Register 5—Bits D5, D4, D3 = '000'		0.9708		
	Ratio of V_{REF} , Register 5—Bits D5, D4, D3 = '001'		0.9610		
	Ratio of V_{REF} , Register 5—Bits D5, D4, D3 = '010'		0.9394		
	Ratio of V_{REF} , Register 5—Bits D5, D4, D3 = '011'		0.9160		
	Ratio of V_{REF} , Register 5—Bits D5, D4, D3 = '100'		0.9102		
	Ratio of V_{REF} , Register 5—Bits D5, D4, D3 = '101'		0.7324		
	Ratio of V_{REF} , Register 5—Bits D5, D4, D3 = '110'		0.5528		
Over-Scale Comparator Offset		+6	+60	+114	mV
Over-Scale Comparator Offset Drift			+0.37		$\text{mV}/^{\circ}\text{C}$
Under-Scale Thresholds	Ratio of V_{REF} , Register 5—Bits D2, D1, D0 = '111'		0.0605		
	Ratio of V_{REF} , Register 5—Bits D2, D1, D0 = '110'		0.0547		
	Ratio of V_{REF} , Register 5—Bits D2, D1, D0 = '101'		0.0507		
	Ratio of V_{REF} , Register 5—Bits D2, D1, D0 = '100'		0.0449		
	Ratio of V_{REF} , Register 5—Bits D2, D1, D0 = '011'		0.0391		
	Ratio of V_{REF} , Register 5—Bits D2, D1, D0 = '010'		0.0352		
	Ratio of V_{REF} , Register 5—Bits D2, D1, D0 = '001'		0.0293		
	Ratio of V_{REF} , Register 5—Bits D2, D1, D0 = '000'		0.0254		
Under-Scale Comparator Offset		-7	-50	+93	mV
Under-Scale Comparator Offset Drift			-0.15		$\text{mV}/^{\circ}\text{C}$
FAULT MONITOR CIRCUIT					
INP_HI, INN_HI Comparator Threshold	See Note 5		$V_{SA}-1.2$ or $V_{EXC}-0.1$		V
INP_LO, INN_LO Comparator Threshold		40	100		mV
A1SAT_HI, A2SAT_HI Comparator Threshold			$V_{SA}-0.12$		V
A1SAT_LO, A2SAT_LO Comparator Threshold			$V_{SA}-0.12$		V
A3_VCM Comparator Threshold			$V_{SA}-1.2$		V
Comparator Hysteresis			20		mV

ELECTRICAL CHARACTERISTICS (continued)

BOLDFACE limits apply over the specified temperature range: $T_A = -40^{\circ}\text{C}$ to $+125^{\circ}\text{C}$

$T_A = +25^{\circ}\text{C}$, $V_{SA} = V_{SD} = +5\text{V}$ ($V_{SA} = V_{\text{SUPPLY ANALOG}}$, $V_{SD} = V_{\text{SUPPLY DIGITAL}}$; V_{SA} must equal V_{SD}), $GND_D = GND_A = 0$, and $V_{REF} = \text{REF}_{IN}/\text{REF}_{OUT} = +5\text{V}$, unless otherwise noted.

PARAMETER	CONDITIONS	PGA309			UNITS
		MIN	TYP	MAX	
INTERNAL VOLTAGE REFERENCE					
V_{REF1}	Register 3, Bit D9 = 1	2.46	2.5	2.53	V
V_{REF1} Drift vs Temperature			+10		ppm/°C
V_{REF2}	Register 3, Bit D9 = 0	4.0	4.096	4.14	V
V_{REF2} Drift vs Temperature			+10		ppm/°C
Input Current $\text{REF}_{IN}/\text{REF}_{OUT}$	Internal V_{REF} Disabled		100		μA
Output Current $\text{REF}_{IN}/\text{REF}_{OUT}$	$V_{SA} > 2.7\text{V}$ for $V_{REF} = 2.5\text{V}$		1		mA
	$V_{SA} > 4.3\text{V}$ for $V_{REF} = 4.096\text{V}$		1		mA
TEMPERATURE SENSE CIRCUITRY (ADC)					
Internal Temperature Measurement Accuracy	Register 6, Bit D9 = 1		± 2		$^{\circ}\text{C}$
Resolution	12-Bit + Sign, Two's Complement Data Format		± 0.0625		$^{\circ}\text{C}$
Temperature Measurement Range		-55		+150	$^{\circ}\text{C}$
Conversion Rate	$R_1, R_0 = '11'$, 12-Bit + Sign Resolution		24		ms
TEMPERATURE ADC					
External Temperature Mode	Temp PGA + Temp ADC				
Gain Range Steps	$G_{PGA} = 1, 2, 4, 8$		1 to 8		V/V
Analog Input Voltage Range		$GND-0.2$		$V_{SA}+0.2$	V
Temperature ADC Internal REF (2.048V)	Register 6, Bit D8 = 1				V
Full-Scale Input Voltage	(+Input) – (-Input)		$\pm 2.048/G_{PGA}$		V
Differential Input Impedance			$2.8/G_{PGA}$		$\text{M}\Omega$
Common-Mode Input Impedance	$G_{PGA} = 1$		3.5		$\text{M}\Omega$
	$G_{PGA} = 2$		3.5		$\text{M}\Omega$
	$G_{PGA} = 4$		1.8		$\text{M}\Omega$
	$G_{PGA} = 8$		0.9		$\text{M}\Omega$
Resolution	$R_1, R_0 = '00'$, ADC2X = '0', Conversion Time = 8ms		11		Bits + Sign
	$R_1, R_0 = '01'$, ADC2X = '0', Conversion Time = 32ms		13		Bits + Sign
	$R_1, R_0 = '10'$, ADC2X = '0', Conversion Time = 64ms		14		Bits + Sign
	$R_1, R_0 = '11'$, ADC2X = '0', Conversion Time = 128ms		15		Bits + Sign
Integral Nonlinearity			0.004		%
Offset Error	$G_{PGA} = 1$		1.2		mV
	$G_{PGA} = 2$		0.7		mV
	$G_{PGA} = 4$		0.5		mV
	$G_{PGA} = 8$		0.4		mV
Offset Drift	$G_{PGA} = 1$		1.2		$\mu\text{V}/^{\circ}\text{C}$
	$G_{PGA} = 2$		0.6		$\mu\text{V}/^{\circ}\text{C}$
	$G_{PGA} = 4$		0.3		$\mu\text{V}/^{\circ}\text{C}$
	$G_{PGA} = 8$		0.3		$\mu\text{V}/^{\circ}\text{C}$
Offset vs V_{SA}	$G_{PGA} = 1$		800		$\mu\text{V}/\text{V}$
	$G_{PGA} = 2$		400		$\mu\text{V}/\text{V}$
	$G_{PGA} = 4$		200		$\mu\text{V}/\text{V}$
	$G_{PGA} = 8$		150		$\mu\text{V}/\text{V}$
Gain Error			0.05	0.50	%
Gain Error Drift			5	50	ppm/°C
Noise	All Gains		< 1		LSB
Gain vs V_{SA}			80		ppm/V
Common-Mode Rejection	At DC and $G_{PGA} = 8$		105		dB
	At DC and $G_{PGA} = 1$		100		dB

ELECTRICAL CHARACTERISTICS (continued)

BOLDFACE limits apply over the specified temperature range: $T_A = -40^{\circ}\text{C}$ to $+125^{\circ}\text{C}$

$T_A = +25^{\circ}\text{C}$, $V_{SA} = V_{SD} = +5\text{V}$ ($V_{SA} = V_{\text{SUPPLY ANALOG}}$, $V_{SD} = V_{\text{SUPPLY DIGITAL}}$; V_{SA} must equal V_{SD}), $G_{ND D} = G_{ND A} = 0$, and $V_{REF} = \text{REF}_{IN}/\text{REF}_{OUT} = +5\text{V}$, unless otherwise noted.

PARAMETER	CONDITIONS	PGA309			UNITS
		MIN	TYP	MAX	
TEMPERATURE ADC (CONTINUED)					
Temp ADC Ext. REF ($V_{\text{REFT}} = V_{\text{REF}}$, V_{EXC} , or V_{SA})	Register 6, Bit D8 = 0				
Full-Scale Input Voltage	(+Input) – (–Input)		$\pm V_{\text{REFT}}/G_{\text{PGA}}$		V
Differential Input Impedance			$2.4/G_{\text{PGA}}$		$\text{M}\Omega$
Common-Mode Input Impedance	$G_{\text{PGA}} = 1$		8		$\text{M}\Omega$
	$G_{\text{PGA}} = 2$		8		$\text{M}\Omega$
	$G_{\text{PGA}} = 4$		8		$\text{M}\Omega$
	$G_{\text{PGA}} = 8$		8		$\text{M}\Omega$
Resolution	R1, R0 = '00', ADC2X = '0', Conversion Time = 6ms		11		Bits + Sign
	R1, R0 = '01', ADC2X = '0', Conversion Time = 24ms		13		Bits + Sign
	R1, R0 = '10', ADC2X = '0', Conversion Time = 50ms		14		Bits + Sign
	R1, R0 = '11', ADC2X = '0', Conversion Time = 100ms		15		Bits + Sign
Integral Nonlinearity			0.01		%
Offset Error	$G_{\text{PGA}} = 1$		2.5		mV
	$G_{\text{PGA}} = 2$		1.25		mV
	$G_{\text{PGA}} = 4$		0.7		mV
	$G_{\text{PGA}} = 8$		0.3		mV
Offset Drift	$G_{\text{PGA}} = 1$		1.5		$\mu\text{V}/^{\circ}\text{C}$
	$G_{\text{PGA}} = 2$		1.0		$\mu\text{V}/^{\circ}\text{C}$
	$G_{\text{PGA}} = 4$		0.7		$\mu\text{V}/^{\circ}\text{C}$
	$G_{\text{PGA}} = 8$		0.6		$\mu\text{V}/^{\circ}\text{C}$
Gain Error			–0.2		%
Gain Error Drift			2		ppm/ $^{\circ}\text{C}$
Gain vs V_{SA}			80		ppm/V
Common-Mode Rejection	At DC and $G_{\text{PGA}} = 8$		100		dB
	At DC and $G_{\text{PGA}} = 1$		85		dB
External Temperature Current Excitation	I_{TEMP}				
Current Excitation	Register 6, Bit D11 = 1	5.8	7	8	μA
Temperature Drift			5		nA/ $^{\circ}\text{C}$
Voltage Compliance			$V_{SA} - 1.2$		V
LINEARIZATION ADJUST AND EXCITATION VOLTAGE (V_{EXC})					
Range 0	Register 3, Bit D11 = 0				
Linearization DAC Range	With Respect to V_{FB}		–0.166 to +0.166		V/V
Linearization DAC Resolution	± 127 Steps, 7-Bit + Sign		1.307		mV/V
V_{EXC} Gain	With Respect to V_{REF}		0.83		V/V
Gain Error Drift			25		ppm/ $^{\circ}\text{C}$
Range 1	Register 3, Bit D11 = 1				
Linearization DAC Range	With Respect to V_{FB}		–0.124 to +0.124		V/V
Linearization DAC Resolution	± 127 Steps, 7-Bit + Sign		0.9764		mV/V
V_{EXC} Gain	With Respect to V_{REF}		0.52		V/V
Gain Error Drift			25		ppm/ $^{\circ}\text{C}$
V_{EXC} Range Upper Limit	$I_{\text{EXC}} = 5\text{mA}$		$V_{SA} - 0.5$		V
$I_{\text{EXC SHORT}}$	Short-Circuit V_{EXC} Output Current		50		mA
DIGITAL INTERFACE					
Two-Wire Compatible	Bus Speed	1		400	kHz
One-Wire	Serial Speed Baud Rate	4.8K		38.4K	Bits/s
Maximum Lookup Table Size ⁽⁶⁾			17 x 3 x 16		Bits
Two-Wire Data Rate	PGA309 to EEPROM (SCL frequency)		65		kHz
LOGIC LEVELS					
Input Levels (SDA, SCL, PRG, TEST)	Low			$0.2 \cdot V_{\text{SD}}$	V
(SDA, SCL, PRG, TEST)	High	$0.7 \cdot V_{\text{SD}}$			V
(SDA, SCL)	Hysteresis		$0.1 \cdot V_{\text{SD}}$		V
Pull-Up Current Source (SDA, SCL)		55	85	125	μA
Pull-Down Current Source (TEST)		15	25	40	μA
Output LOW Level (SDA, SCL, PRG)	Open Drain, $I_{\text{SINK}} = 5\text{mA}$			0.4	V

ELECTRICAL CHARACTERISTICS (continued)

BOLDFACE limits apply over the specified temperature range: $T_A = -40^{\circ}\text{C}$ to $+125^{\circ}\text{C}$

$T_A = +25^{\circ}\text{C}$, $V_{SA} = V_{SD} = +5\text{V}$ ($V_{SA} = V_{\text{SUPPLY ANALOG}}$, $V_{SD} = V_{\text{SUPPLY DIGITAL}}$; V_{SA} must equal V_{SD}), $GND_D = GND_A = 0$, and $V_{REF} = \text{REF}_{IN}/\text{REF}_{OUT} = +5\text{V}$, unless otherwise noted.

PARAMETER	CONDITIONS	PGA309			UNITS
		MIN	TYP	MAX	
POWER SUPPLY V_{SA} , V_{SD} $I_{SA} + I_{SD}$, Quiescent Current	$V_{SA} = V_{SD} = +5\text{V}$, without Bridge Load	2.7	1.2	5.5 1.6	V mA
POWER-ON RESET Power-Up Threshold Power-Down Threshold	V_{SA} Rising V_{SA} Falling		2.2 1.7	2.7	V V
TEMPERATURE RANGE Specified Performance Operational – Degraded Performance		-40 -55		+125 +150	$^{\circ}\text{C}$ $^{\circ}\text{C}$

- (1) PGA309 total differential gain from input ($V_{IN1}-V_{IN2}$) to output (V_{OUT}): $V_{OUT} / (V_{IN1}-V_{IN2}) = (\text{Front-End PGA gain}) (\text{Output Amplifier gain}) (\text{Gain DAC})$.
- (2) RTI = referred to input. RTO = referred to output.
- (3) Linear input range is the allowed min/max voltage on the V_{IN1} and V_{IN2} pins for the input PGA to continue to operate in a linear region. The allowed common-mode and differential voltage is dependent upon gain and offset settings. Refer to the Gain Scaling section for more information.
- (4) Unless limited by over/under-scale setting.
- (5) When V_{EXC} is enabled, a minimum reference selector circuit becomes the reference for the comparator threshold. This minimum reference selector circuit uses $V_{EXC} - 100\text{mV}$ and $V_{SA} - 1.2\text{V}$ and compares the V_{INX} pin to the lower of the two references. This ensures accurate fault monitoring in conditions where V_{EXC} might be higher or lower than the input CMR of the PGA input amplifier relative to V_{SA} .
- (6) Lookup Table allows multislope compensation over temperature. Lookup Table has access to 17 calibration points consisting of 3 adjustment values (Tx, Temperature, ZMx, Zero DAC, GMx, Gain DAC) that are stored in 16-bit data format ($17 \times 3 \times 16 = \text{Lookup Table size}$).

PIN CONFIGURATION

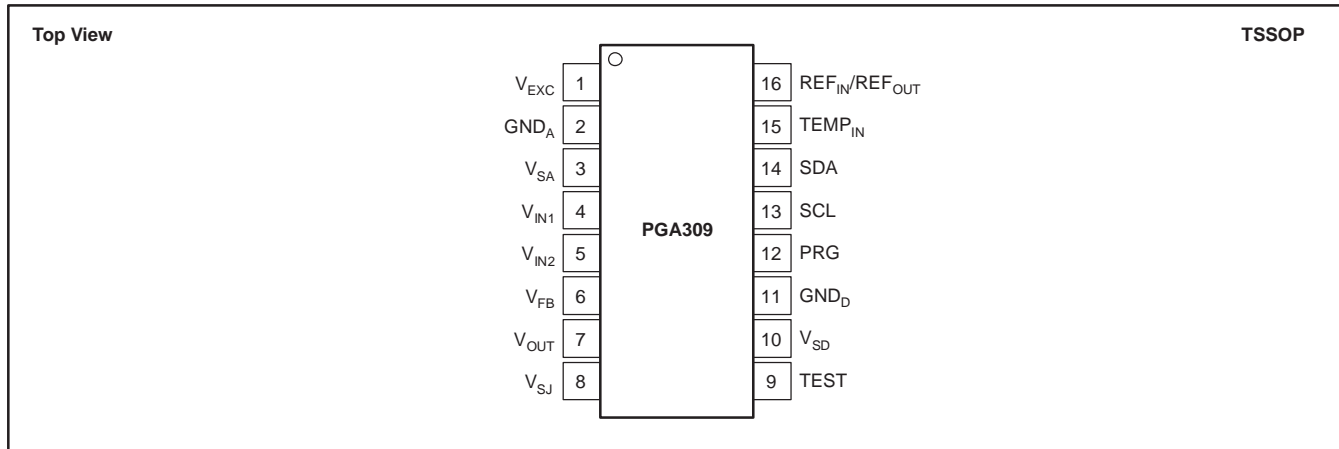

PIN DESCRIPTION

PIN	NAME	DESCRIPTION
1	V _{EXC}	Bridge sensor excitation. Connect to bridge if linearization and/or internal reference for bridge excitation is to be used.
2	GND _A	Analog ground. Connect to analog ground return path for V _{SA} . Should be same as GND _D .
3	V _{SA}	Analog voltage supply. Connect to analog voltage supply. To be within 200mV of V _{SD} .
4	V _{IN1}	Signal input voltage 1. Connect to + or – output of sensor bridge. Internal multiplexer can change connection internally to Front-End PGA.
5	V _{IN2}	Signal input voltage 2. Connect to + or – output of sensor bridge. Internal multiplexer can change connection internally to Front-End PGA.
6	V _{FB}	V _{OUT} feedback pin. Voltage feedback sense point for over/under-scale limit circuitry. When internal gain set resistors for the output amplifier are used, this is also the voltage feedback sense point for the output amplifier. V _{FB} in combination with V _{SJ} allows for ease of external filter and protection circuits without degrading the PGA309 V _{OUT} accuracy. V _{FB} must always be connected to either V _{OUT} or the point of feedback for V _{OUT} , if external protection is used.
7	V _{OUT}	Analog output voltage of conditioned sensor.
8	V _{SJ}	Output amplifier summing junction. Use for output amplifier compensation when driving large capacitive loads (> 100pF) and/or for using external gain setting resistors for the output amplifier.
9	TEST	Test/External Controller Mode pin. Pull to GND _D in normal mode.
10	V _{SD}	Digital voltage supply. Connect to digital voltage supply. To be within 200mV of V _{SA} .
11	GND _D	Digital ground. Connect to digital ground return path for V _{SD} . Should be same as GND _A .
12	PRG	Single-wire interface program pin. UART-type interface for digital calibration of the PGA309 over a single wire. Can be connected to V _{OUT} for a three-lead (V _S , GND, V _{OUT}) digitally-programmable sensor assembly.
13	SCL	Clock input/output for Two-Wire, industry-standard compatible interface for reading and writing digital calibration and configuration from external EEPROM. Can also communicate directly to the registers in the PGA309 through the Two-Wire, industry-standard compatible interface.
14	SDA	Data input/output for Two-Wire, industry-standard compatible interface for reading and writing digital calibration and configuration from external EEPROM. Can also communicate directly to the registers in the PGA309 through the Two-Wire, industry-standard compatible interface.
15	TEMP _{IN}	External temperature signal input. PGA309 can be configured to read a bridge current sense resistor as an indicator of bridge temperature, or an external temperature sensing device such as diode junction, RTD, or thermistor. This input can be internally gained by 1, 2, 4, or 8. In addition, this input can be read differentially with respect to V _{GND_A} , V _{EXC} , or the internal/external V _{REF} . There is also an internal, register-selectable, 7μA current source (I _{TEMP}) that can be connected to TEMP _{IN} as an RTD, thermistor, or diode excitation source.
16	REF _{IN} /REF _{OUT}	Reference input/output pin. As an output, the internal reference (selectable as 2.5V or 4.096V) is available for system use on this pin. As an input, the internal reference may be disabled and an external reference can then be applied as the reference for the PGA309.

TYPICAL CHARACTERISTICS

$T_A = +25^\circ\text{C}$, $V_{SA} = V_{SD} = +5\text{V}$ ($V_{SA} = V_{\text{SUPPLY ANALOG}}$, $V_{SD} = V_{\text{SUPPLY DIGITAL}}$, V_{SA} must equal V_{SD}), $G_{ND D} = G_{ND A} = 0$, and $V_{REF} = \text{REF}_{IN}/\text{REF}_{OUT} = +5\text{V}$, unless otherwise noted.

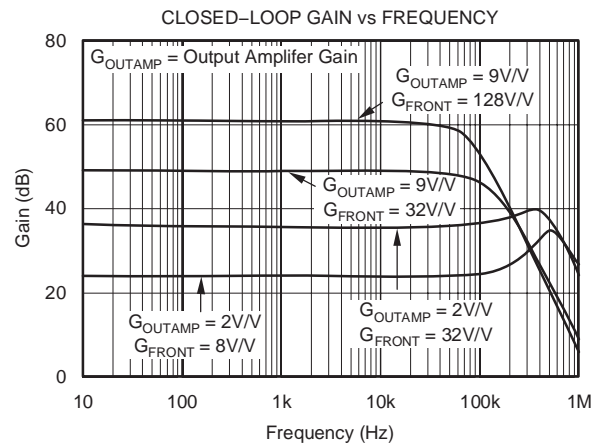
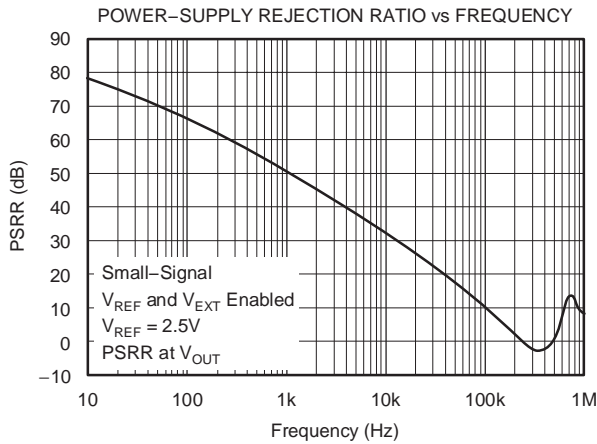
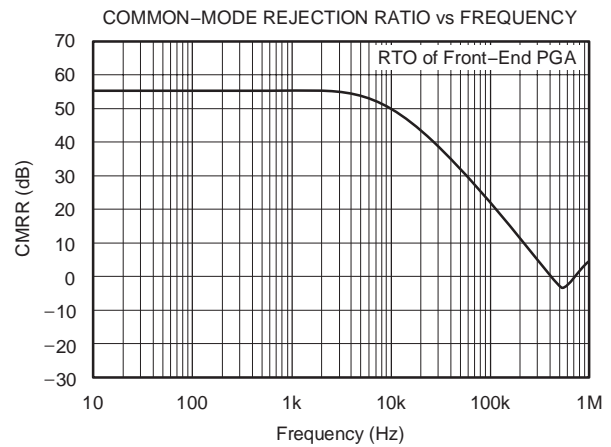
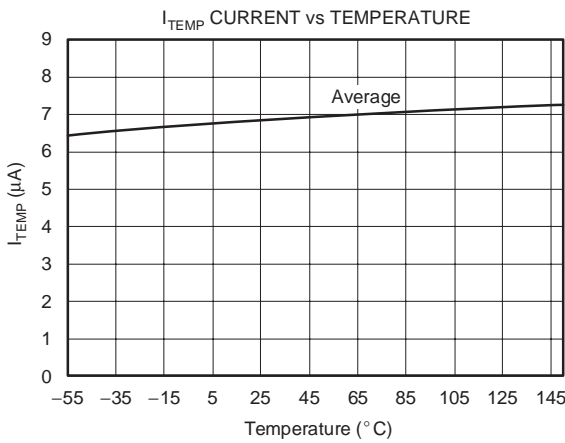
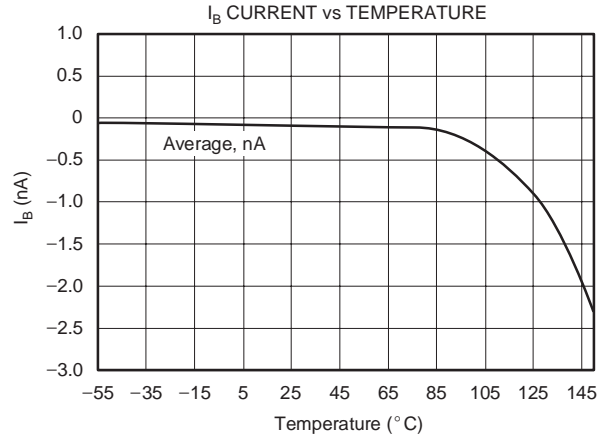
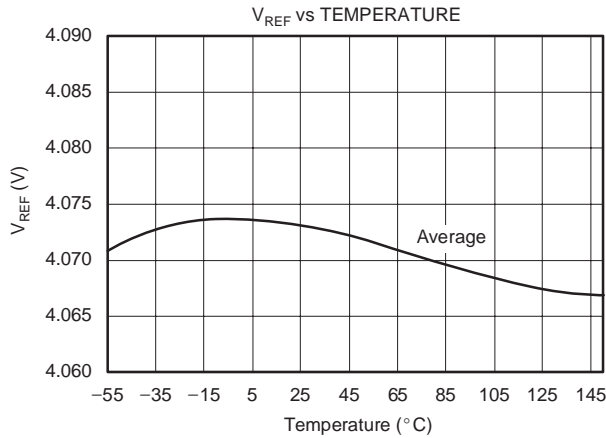

TYPICAL CHARACTERISTICS (Cont.)

$T_A = +25^\circ\text{C}$, $V_{SA} = V_{SD} = +5\text{V}$ ($V_{SA} = V_{\text{SUPPLY ANALOG}}$, $V_{SD} = V_{\text{SUPPLY DIGITAL}}$, V_{SA} must equal V_{SD}), $\text{GND}_D = \text{GND}_A = 0$, and $V_{\text{REF}} = \text{REF}_{\text{IN}}/\text{REF}_{\text{OUT}} = +5\text{V}$, unless otherwise noted.

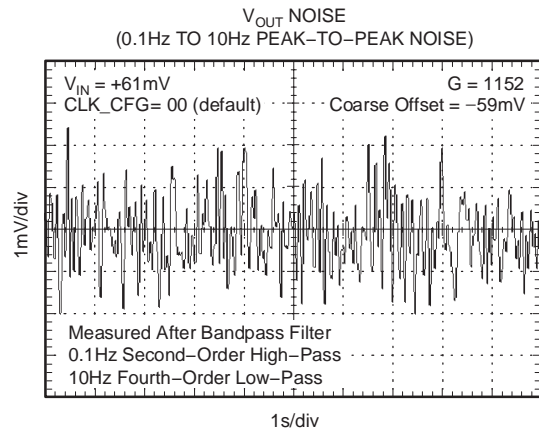
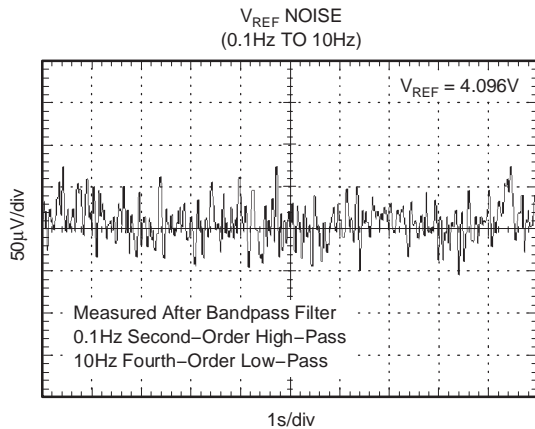
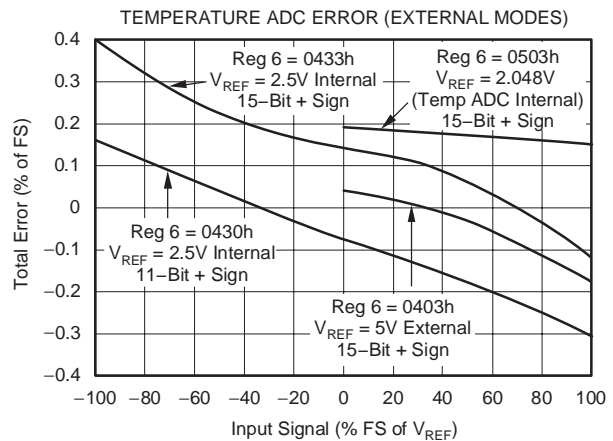
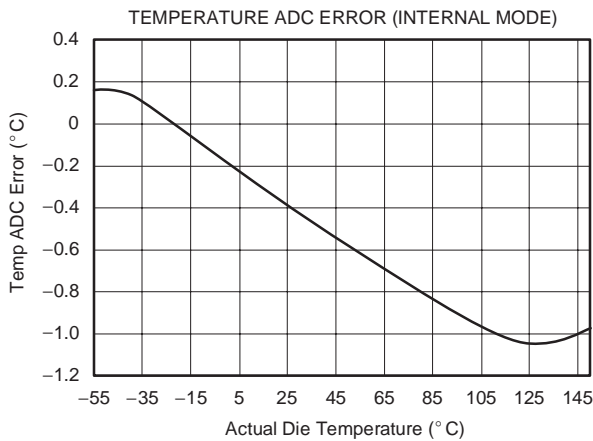
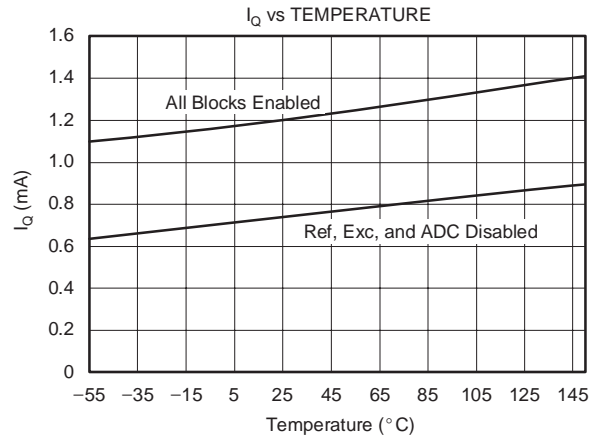
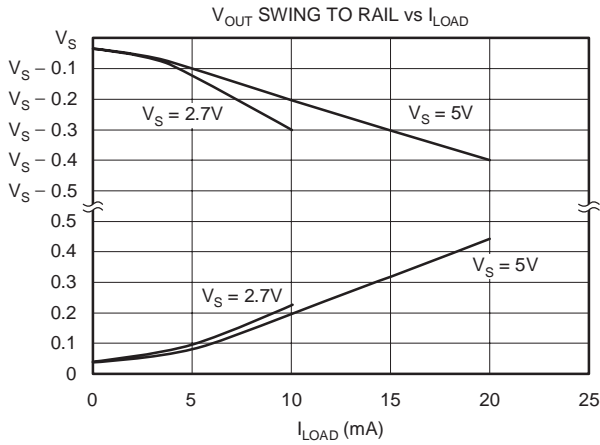

TYPICAL CHARACTERISTICS (Cont.)

$T_A = +25^\circ\text{C}$, $V_{SA} = V_{SD} = +5\text{V}$ ($V_{SA} = V_{\text{SUPPLY ANALOG}}$, $V_{SD} = V_{\text{SUPPLY DIGITAL}}$, V_{SA} must equal V_{SD}), $GND_D = GND_A = 0$, and $V_{REF} = REF_{IN}/REF_{OUT} = +5\text{V}$, unless otherwise noted.

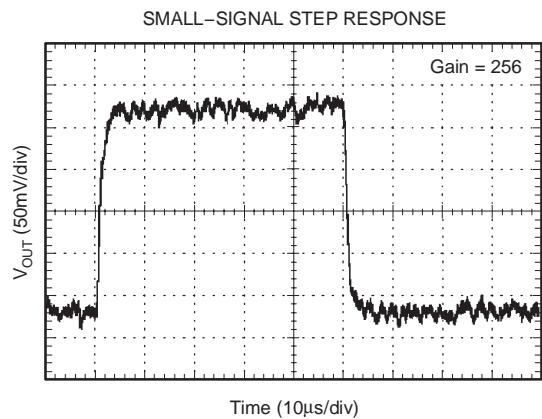
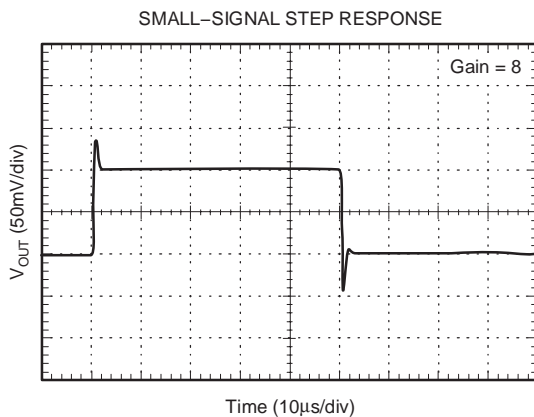
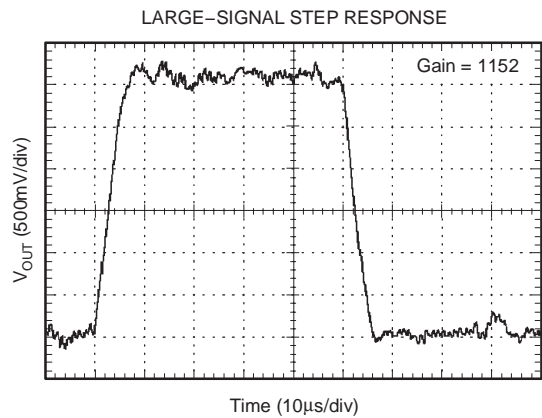
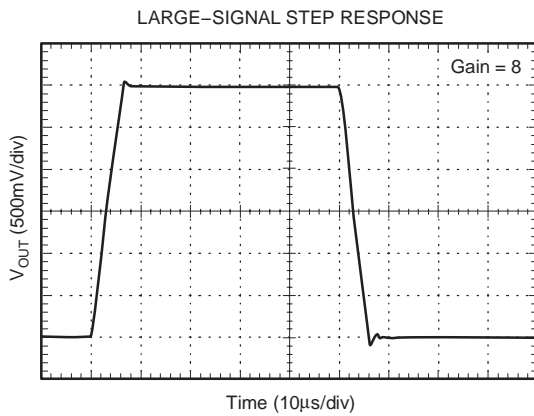
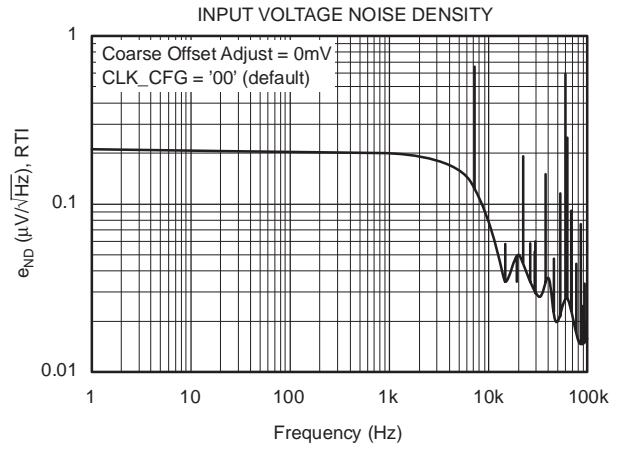
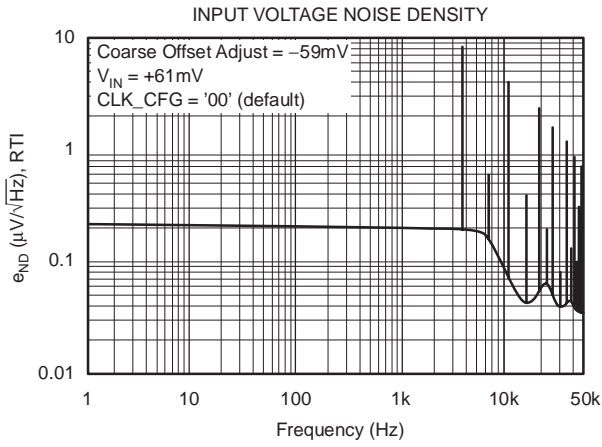

TYPICAL CHARACTERISTICS (Cont.)

$T_A = +25^\circ\text{C}$, $V_{SA} = V_{SD} = +5\text{V}$ ($V_{SA} = V_{\text{SUPPLY ANALOG}}$, $V_{SD} = V_{\text{SUPPLY DIGITAL}}$, V_{SA} must equal V_{SD}), $GND_D = GND_A = 0$, and $V_{REF} = \text{REF}_{IN}/\text{REF}_{OUT} = +5\text{V}$, unless otherwise noted.

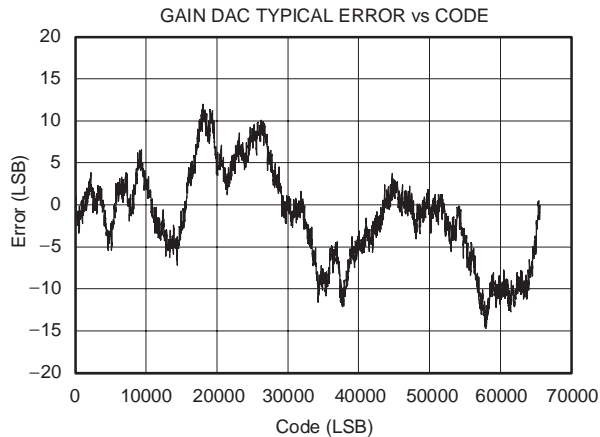
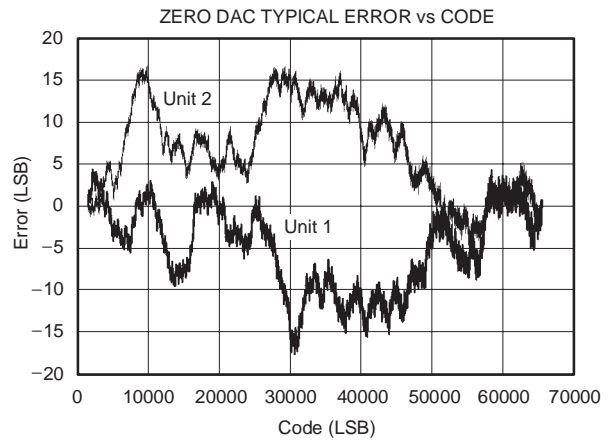
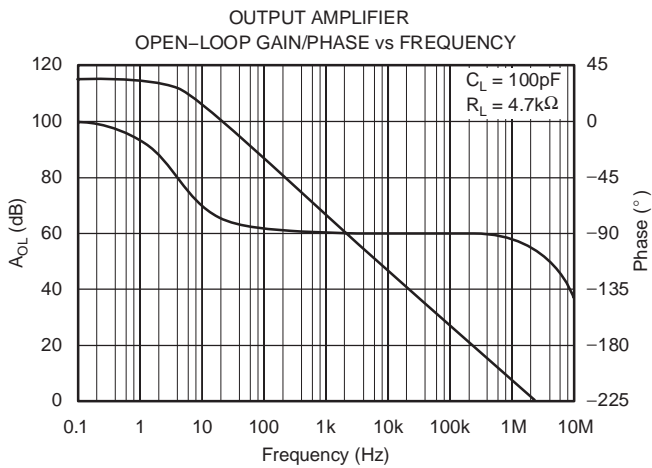
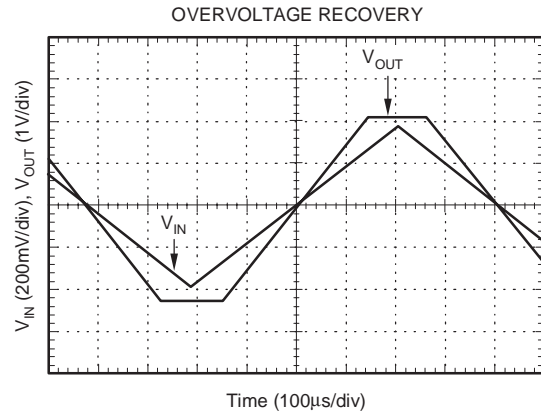
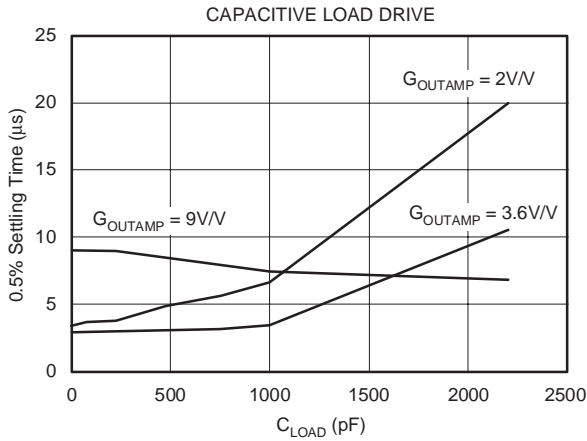

FUNCTIONAL DESCRIPTION

The PGA309 is a programmable analog signal conditioner designed for resistive bridge sensor applications. It is a complete signal conditioner with bridge excitation, initial span and offset adjustment, temperature adjustment of span and offset, internal/external temperature measurement capability, output over-scale and under-scale limiting, fault detection, and digital calibration. The PGA309, in a calibrated sensor module, can reduce errors to the level approaching the bridge sensor repeatability. Figure 1 shows a block diagram of the PGA309. Following is a brief overview of each major function.

SENSOR ERROR ADJUSTMENT RANGE

The adjustment capability of the PGA309 is summarized in Table 1.

FSS (full-scale sensitivity)	1mV/V to 245mV/V
Span TC	Over $\pm 3300\text{ppmFS}/^\circ\text{C}$ (1)
Span TC nonlinearity	$\geq 10\%$
Zero offset	$\pm 200\%FS$ (2)
Zero offset TC	Over $\pm 3000\text{ppmFS}/^\circ\text{C}$ (2)
Zero offset TC nonlinearity	$\geq 10\%$
Sensor impedance	Down to 200Ω (3)
(1) Depends on the temperature sensing scheme	
(2) Combined coarse and fine offset adjust	
(3) Lower impedance possible by using a dropping resistor in series with the bridge	

Table 1. PGA309 Adjustment Capability

GAIN SCALING

The core of the PGA309 is the precision low-drift and no 1/f noise Front-End PGA. The overall gain of the Front-End PGA + Output Amplifier can be adjusted from 2.7V/V to 1152V/V. The polarity of the inputs can be switched through the 2x2 input mux to accommodate sensors with unknown polarity output.

The Front-End PGA provides initial coarse signal gain using a no 1/f noise, auto-zero instrumentation amplifier. The fine gain adjust is accomplished by the 16-bit attenuating Gain Digital-to-Analog Converter (Gain DAC). This Gain DAC is controlled by the data in the Temperature Compensation Lookup Table driven by the Temperature Analog-to-Digital Converter (Temp ADC). In order to compensate for second-order and higher drift nonlinearity, the span drift can be fitted to

piecewise linear curves during calibration with the coefficients stored in an external nonvolatile EEPROM lookup table.

Following the fine gain adjust stage is the Output Amplifier that provides additional programmable gain. Two key output amplifier connections, V_{FB} and V_{SJ} , are brought out on the PGA309 for application flexibility. These connections allow for an accurate conditioned signal voltage while also providing a means for PGA309 output overvoltage and large capacitive loading for RFI/EMI filtering required in many end applications.

OFFSET ADJUSTMENT

The sensor offset adjustment is performed in two stages. The input-referred Coarse Offset Adjust DAC has approximately a $\pm 60\text{mV}$ offset adjustment range for a selected V_{REF} of 5V. The fine offset and the offset drift are canceled by the 16-bit Zero DAC that sums the signal with the output of the front-end instrumentation amplifier. Similar to the Gain DAC, the input digital values of the Zero DAC are controlled by the data in the Temperature Compensation Lookup Table, stored in external EEPROM, driven by the Temp ADC. The programming range of the Zero DAC is 0V to V_{REF} with an output range of 0.1V to $V_{SA} - 0.1\text{V}$.

VOLTAGE REFERENCE

The PGA309 contains a precision low-drift voltage reference (selectable for 2.5V or 4.096V) that can be used for external circuitry through the REF_{IN}/REF_{OUT} pin. This same reference is used for the Coarse Offset Adjust DAC, Zero DAC, Over/Under-Scale Limits and sensor excitation/linearization through the V_{EXC} pin. When the internal reference is disabled, the REF_{IN}/REF_{OUT} pin should be connected to an external reference or to V_{SA} for ratiometric-scaled systems.

SENSOR EXCITATION AND LINEARIZATION

A dedicated circuit with a 7-bit + sign DAC for sensor voltage excitation and linearization is provided on the PGA309. This block scales the reference voltage and sums it with a portion of the PGA309 output to compensate the positive or negative bow-shaped nonlinearity exhibited by many sensors over their applied pressure range. Sensors not requiring linearization can be connected directly to the supply (V_{SA}) or to the V_{EXC} pin with the Linearization DAC (Lin DAC) set to zero.

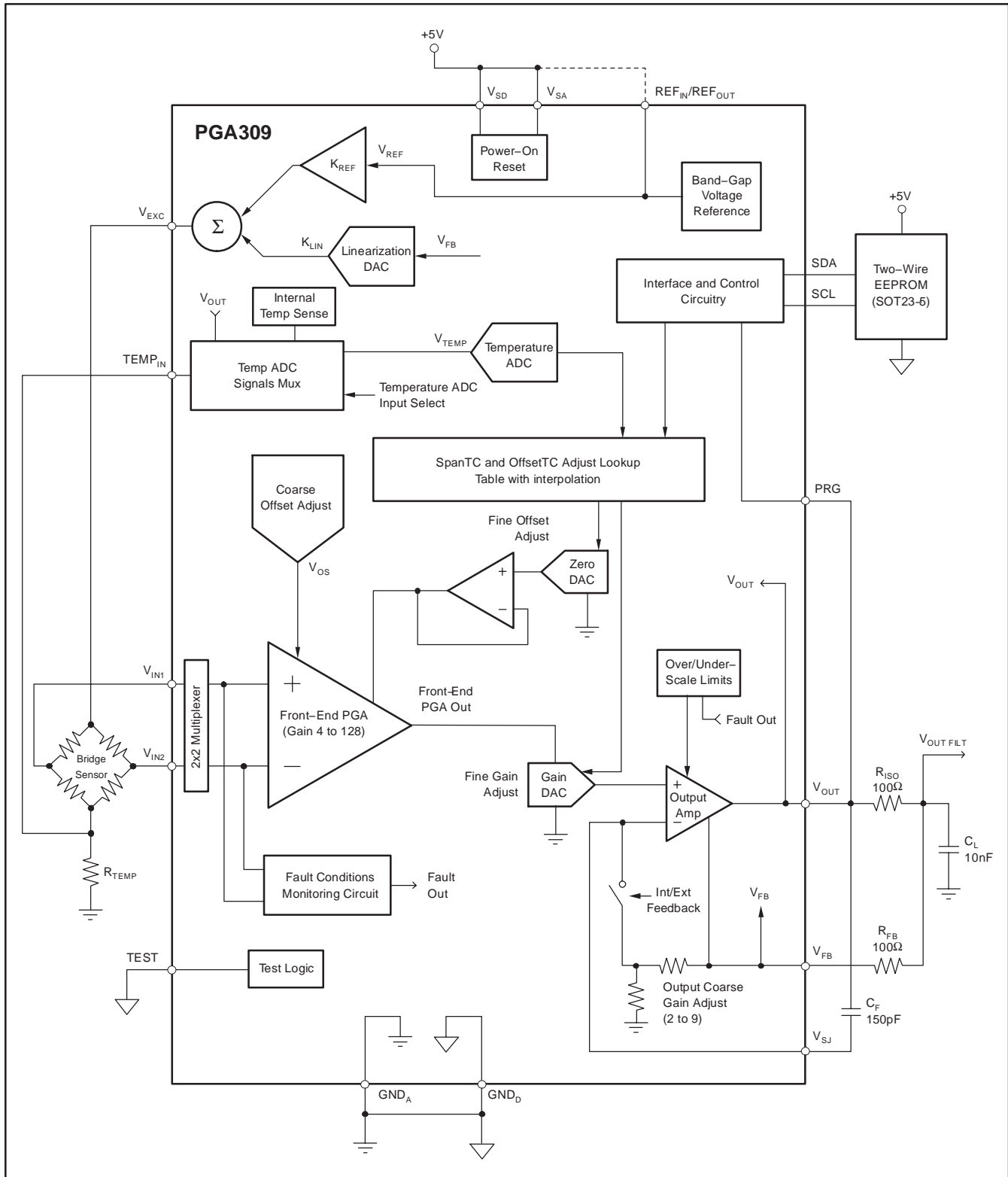

Figure 1. Simplified Diagram of the PGA309 in a Typical Configuration.

ADC FOR TEMPERATURE SENSING

The temperature sense circuitry drives the compensation for the sensor span and offset drift. Either internal or external temperature sensing is possible. The temperature can be sensed in one of the following ways:

- Bridge impedance change (excitation current sense, in the positive or negative part of the bridge), for sensors with large temperature coefficient of resistance ($TCR > 0.1\%/^{\circ}C$).
- On-chip PGA309 temperature, when the chip is located sufficiently close to the sensor.
- External diode, thermistor, or RTD placed on the sensor membrane. An internal $7\mu A$ current source may be enabled to excite these types of temperature sensors.

The temperature signal is digitized by the onboard Temp ADC. The output of the Temp ADC is used by the control digital circuit to read the data from the Lookup Table in an external EEPROM, and set the output of the Gain DAC and the Zero DAC to the calibrated values as temperature changes.

An additional function provided through the Temp ADC is the ability to read the V_{OUT} pin back through the Temp ADC input mux. This provides flexibility for a digital output through either One-Wire or Two-Wire interface, as well as the possibility for an external microcontroller to perform real-time custom calibration of the PGA309.

EXTERNAL EEPROM AND TEMPERATURE COEFFICIENTS

The PGA309 uses an industry-standard Two-Wire external EEPROM (typically, a SOT23-5 package). A 1k-bit (minimum) EEPROM is needed when using all 17 temperature coefficients. Larger EEPROMs may be used to provide space for a serial number, lot code, or other data.

The first part of the external EEPROM contains the configuration data for the PGA309, with settings for:

- Register 3—Reference Control and Linearization
- Register 4—PGA Coarse Offset and Gain/Output Amplifier Gain
- Register 5—PGA Configuration and Over/Under-Scale Limit
- Register 6—Temp ADC Control

This section of the EEPROM contains its own individual checksum (Checksum1).

The second part of the external EEPROM contains up to 17 temperature index values and corresponding temperature coefficients for the Zero DAC and Gain DAC adjustments with measured temperature, and also contains its own checksum (Checksum2).

The PGA309 lookup logic contains a linear interpolation algorithm for accurate DAC adjustments between stored temperature indexes. This approach allows for a piecewise linear temperature compensation of up to 17 temperature indexes and associated temperature coefficients.

If either Checksum1, Checksum2, or both are incorrect, the output of the PGA309 is set to high-impedance.

FAULT MONITOR

To detect sensor burnout or a short, a set of four comparators are connected to the inputs of the Front-End PGA. If any of the inputs are taken to within 100mV of ground or V_{EXC} , or violate the input CMR of the Front-End PGA, then the corresponding comparator sets a sensor fault flag that causes the PGA309 V_{OUT} to be driven within 100mV of either V_{SA} or ground, depending upon the alarm configuration setting (Register 5—PGA Configuration and Over/Under-Scale Limit). This will be well above the set Over-Scale Limit level or well below the set Under-Scale Limit level. The state of the fault condition can be read in digital form in Register 8—Alarm Status Register. If the Over/Under-Scale Limit is disabled, the PGA309 output voltage will still be driven within 100mV of either V_{SA} or ground, depending upon the alarm configuration setting.

There are five other fault detect comparators that help detect subtle PGA309 front-end violations that could otherwise result in linear voltages at V_{OUT} that would be interpreted as valid states. These are especially useful during factory calibration and setup, and are configured through Register 5—PGA Configuration and Over/Under-Scale Limit. Their status can also be read back through Register 8—Alarm Status Register.

OVER-SCALE AND UNDER-SCALE LIMITS

The over-scale and under-scale limit circuitry combined with the fault monitor circuitry provides a means for system diagnostics. A typical sensor-conditioned output may be scaled for 10% to 90% of the system ADC range for the sensor normal operating range. If the conditioned pressure sensor is below 4%, it is considered under-pressure; if over 96%, it is considered over-pressure.

The PGA309 over/under-scale limit circuit can be programmed individually for under-scale and over-scale values that clip or limit the PGA309 output. From a system diagnostic view, 10% to 90% of ADC range is normal operation, < 4% is under-pressure, and > 96% is over-pressure. If the fault detect circuitry is used, a detected fault will cause the PGA309 output to be driven to positive or negative saturation. If this fault

flag is programmed for high, then > 97% ADC range will be a fault; if programmed for low, then < 3% ADC range will be a fault. In this configuration, the system software can be used to distinguish between over- or under-pressure condition, which indicates an out-of-control process, or a sensor fault.

POWER-UP AND NORMAL OPERATION

The PGA309 has circuitry to detect when the power supply is applied to the PGA309, and reset the internal registers and circuitry to an initial state. This reset also occurs when the supply is detected to be invalid, so that the PGA309 is in a known state when the supply becomes valid again. The rising threshold for this circuit is typically 2.2V and the falling threshold is typically 1.7V. After the power supply becomes valid, the PGA309 waits for approximately 25ms and then attempts to read the configuration data from the external EEPROM device.

If the EEPROM has the proper flag set in address locations 0 and 1, then the PGA309 continues reading the first part of the EEPROM; otherwise, the PGA309 waits for one second before trying again. If the PGA309 detects no response from the EEPROM, the PGA309 waits for one second and tries again; otherwise, the PGA309 tries to free the bus and waits for 25ms before trying to read the EEPROM again. If a successful read of the first part of the EEPROM is accomplished, (including valid Checksum1 data), the PGA309 triggers the Temp ADC to measure temperature. For 16-bit resolution results, the converter takes approximately 125ms to complete a conversion. Once the conversion is complete, the PGA309 begins reading the Lookup Table information from the EEPROM (second part) to calculate the settings for the Gain DAC and Zero DAC.

The PGA309 reads the entire Lookup Table so that it can determine if the checksum for the Lookup Table (Checksum2) is correct. Each entry in the Lookup Table requires approximately 500 μ s to read from the

EEPROM. Once the checksum is determined to be valid, the calculated values for the Gain and Zero DACs are updated into their respective registers, and the output amplifier is enabled. The PGA309 then begins looping through this entire procedure, starting with reading the EEPROM configuration registers from the first part of the EEPROM, then starting a new conversion on the Temp ADC, which then triggers reading the Lookup Table data from the second part of the EEPROM. This loop continues indefinitely.

DIGITAL INTERFACE

There are two digital interfaces on the PGA309. The PRG pin uses a One-Wire, UART-compatible interface with bit rates from 4.8Kbits/s to 38.4Kbits/s. The SDA and SCL pins together form an industry standard Two-Wire interface at clock rates from 1kHz to 400kHz. The external EEPROM uses the Two-Wire interface. Communication to the PGA309 internal registers, as well as to the external EEPROM, for programming and readback can be conducted through either digital interface.

It is also possible to connect the One-Wire communication pin, PRG, to the V_{OUT} pin in true three-wire sensor modules and still allow for programming. In this mode, the PGA309 output amplifier may be enabled for a set time period and then disabled again to allow sharing of the PRG pin with the V_{OUT} connection. This allows for both digital calibration and analog readback during sensor calibration in a three-wire sensor module.

The Two-Wire interface has timeout mechanisms to prevent bus lockup from occurring. The Two-Wire master controller in the PGA309 has a mode that attempts to free up a stuck-at-zero SDA line by issuing SCL pulses, even when the bus is not indicated as idle after a timeout period has expired. The timeout will only apply when the master portion of the PGA309 is attempting to initiate a Two-Wire communication.

DETAILED BLOCK DIAGRAM

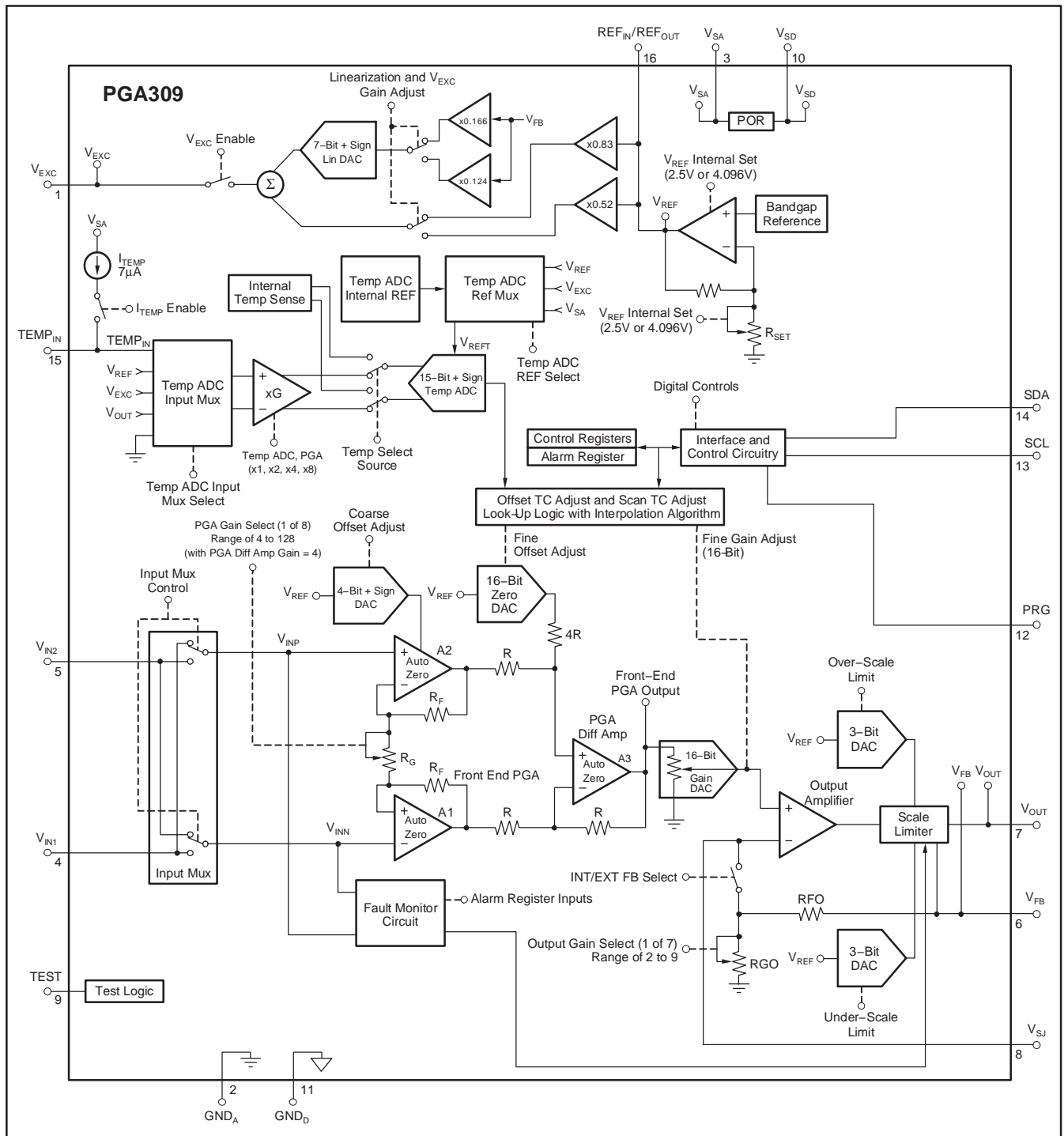

Figure 2. Detailed Block Diagram

PACKAGING INFORMATION

Orderable Device	Status ⁽¹⁾	Package Type	Package Drawing	Pins	Package Qty	Eco Plan ⁽²⁾	Lead/Ball Finish	MSL Peak Temp ⁽³⁾
PGA309AIPWR	ACTIVE	TSSOP	PW	16	2500	Green (RoHS & no Sb/Br)	CU NIPDAU	Level-1-260C-UNLIM
PGA309AIPWRG4	ACTIVE	TSSOP	PW	16	2500	Green (RoHS & no Sb/Br)	CU NIPDAU	Level-1-260C-UNLIM
PGA309AIPWT	ACTIVE	TSSOP	PW	16	250	Green (RoHS & no Sb/Br)	CU NIPDAU	Level-1-260C-UNLIM
PGA309AIPWTG4	ACTIVE	TSSOP	PW	16	250	Green (RoHS & no Sb/Br)	CU NIPDAU	Level-1-260C-UNLIM

⁽¹⁾ The marketing status values are defined as follows:

ACTIVE: Product device recommended for new designs.

LIFEBUY: TI has announced that the device will be discontinued, and a lifetime-buy period is in effect.

NRND: Not recommended for new designs. Device is in production to support existing customers, but TI does not recommend using this part in a new design.

PREVIEW: Device has been announced but is not in production. Samples may or may not be available.

OBSOLETE: TI has discontinued the production of the device.

⁽²⁾ Eco Plan - The planned eco-friendly classification: Pb-Free (RoHS), Pb-Free (RoHS Exempt), or Green (RoHS & no Sb/Br) - please check <http://www.ti.com/productcontent> for the latest availability information and additional product content details.

TBD: The Pb-Free/Green conversion plan has not been defined.

Pb-Free (RoHS): TI's terms "Lead-Free" or "Pb-Free" mean semiconductor products that are compatible with the current RoHS requirements for all 6 substances, including the requirement that lead not exceed 0.1% by weight in homogeneous materials. Where designed to be soldered at high temperatures, TI Pb-Free products are suitable for use in specified lead-free processes.

Pb-Free (RoHS Exempt): This component has a RoHS exemption for either 1) lead-based flip-chip solder bumps used between the die and package, or 2) lead-based die adhesive used between the die and leadframe. The component is otherwise considered Pb-Free (RoHS compatible) as defined above.

Green (RoHS & no Sb/Br): TI defines "Green" to mean Pb-Free (RoHS compatible), and free of Bromine (Br) and Antimony (Sb) based flame retardants (Br or Sb do not exceed 0.1% by weight in homogeneous material)

⁽³⁾ MSL, Peak Temp. -- The Moisture Sensitivity Level rating according to the JEDEC industry standard classifications, and peak solder temperature.

Important Information and Disclaimer: The information provided on this page represents TI's knowledge and belief as of the date that it is provided. TI bases its knowledge and belief on information provided by third parties, and makes no representation or warranty as to the accuracy of such information. Efforts are underway to better integrate information from third parties. TI has taken and continues to take reasonable steps to provide representative and accurate information but may not have conducted destructive testing or chemical analysis on incoming materials and chemicals. TI and TI suppliers consider certain information to be proprietary, and thus CAS numbers and other limited information may not be available for release.

In no event shall TI's liability arising out of such information exceed the total purchase price of the TI part(s) at issue in this document sold by TI to Customer on an annual basis.

TAPE AND REEL INFORMATION



QUADRANT ASSIGNMENTS FOR PIN 1 ORIENTATION IN TAPE



*All dimensions are nominal

Device	Package Type	Package Drawing	Pins	SPQ	Reel Diameter (mm)	Reel Width W1 (mm)	A0 (mm)	B0 (mm)	K0 (mm)	P1 (mm)	W (mm)	Pin1 Quadrant
PGA309AIPWR	TSSOP	PW	16	2500	330.0	12.4	7.0	5.6	1.6	8.0	12.0	Q1
PGA309AIPWT	TSSOP	PW	16	250	180.0	12.4	7.0	5.6	1.6	8.0	12.0	Q1

TAPE AND REEL BOX DIMENSIONS



*All dimensions are nominal

Device	Package Type	Package Drawing	Pins	SPQ	Length (mm)	Width (mm)	Height (mm)
PGA309AIPWR	TSSOP	PW	16	2500	346.0	346.0	29.0
PGA309AIPWT	TSSOP	PW	16	250	190.5	212.7	31.8

PW (R-PDSO-G**)

PLASTIC SMALL-OUTLINE PACKAGE

14 PINS SHOWN



4040064/F 01/97

- NOTES: A. All linear dimensions are in millimeters.
 B. This drawing is subject to change without notice.
 C. Body dimensions do not include mold flash or protrusion not to exceed 0,15.
 D. Falls within JEDEC MO-153

IMPORTANT NOTICE

Texas Instruments Incorporated and its subsidiaries (TI) reserve the right to make corrections, modifications, enhancements, improvements, and other changes to its products and services at any time and to discontinue any product or service without notice. Customers should obtain the latest relevant information before placing orders and should verify that such information is current and complete. All products are sold subject to TI's terms and conditions of sale supplied at the time of order acknowledgment.

TI warrants performance of its hardware products to the specifications applicable at the time of sale in accordance with TI's standard warranty. Testing and other quality control techniques are used to the extent TI deems necessary to support this warranty. Except where mandated by government requirements, testing of all parameters of each product is not necessarily performed.

TI assumes no liability for applications assistance or customer product design. Customers are responsible for their products and applications using TI components. To minimize the risks associated with customer products and applications, customers should provide adequate design and operating safeguards.

TI does not warrant or represent that any license, either express or implied, is granted under any TI patent right, copyright, mask work right, or other TI intellectual property right relating to any combination, machine, or process in which TI products or services are used. Information published by TI regarding third-party products or services does not constitute a license from TI to use such products or services or a warranty or endorsement thereof. Use of such information may require a license from a third party under the patents or other intellectual property of the third party, or a license from TI under the patents or other intellectual property of TI.

Reproduction of TI information in TI data books or data sheets is permissible only if reproduction is without alteration and is accompanied by all associated warranties, conditions, limitations, and notices. Reproduction of this information with alteration is an unfair and deceptive business practice. TI is not responsible or liable for such altered documentation. Information of third parties may be subject to additional restrictions.

Resale of TI products or services with statements different from or beyond the parameters stated by TI for that product or service voids all express and any implied warranties for the associated TI product or service and is an unfair and deceptive business practice. TI is not responsible or liable for any such statements.

TI products are not authorized for use in safety-critical applications (such as life support) where a failure of the TI product would reasonably be expected to cause severe personal injury or death, unless officers of the parties have executed an agreement specifically governing such use. Buyers represent that they have all necessary expertise in the safety and regulatory ramifications of their applications, and acknowledge and agree that they are solely responsible for all legal, regulatory and safety-related requirements concerning their products and any use of TI products in such safety-critical applications, notwithstanding any applications-related information or support that may be provided by TI. Further, Buyers must fully indemnify TI and its representatives against any damages arising out of the use of TI products in such safety-critical applications.

TI products are neither designed nor intended for use in military/aerospace applications or environments unless the TI products are specifically designated by TI as military-grade or "enhanced plastic." Only products designated by TI as military-grade meet military specifications. Buyers acknowledge and agree that any such use of TI products which TI has not designated as military-grade is solely at the Buyer's risk, and that they are solely responsible for compliance with all legal and regulatory requirements in connection with such use.

TI products are neither designed nor intended for use in automotive applications or environments unless the specific TI products are designated by TI as compliant with ISO/TS 16949 requirements. Buyers acknowledge and agree that, if they use any non-designated products in automotive applications, TI will not be responsible for any failure to meet such requirements.

Following are URLs where you can obtain information on other Texas Instruments products and application solutions:

Products

Amplifiers	amplifier.ti.com
Data Converters	dataconverter.ti.com
DLP® Products	www.dlp.com
DSP	dsp.ti.com
Clocks and Timers	www.ti.com/clocks
Interface	interface.ti.com
Logic	logic.ti.com
Power Mgmt	power.ti.com
Microcontrollers	microcontroller.ti.com
RFID	www.ti-rfid.com
RF/IF and ZigBee® Solutions	www.ti.com/lprf

Applications

Audio	www.ti.com/audio
Automotive	www.ti.com/automotive
Broadband	www.ti.com/broadband
Digital Control	www.ti.com/digitalcontrol
Medical	www.ti.com/medical
Military	www.ti.com/military
Optical Networking	www.ti.com/opticalnetwork
Security	www.ti.com/security
Telephony	www.ti.com/telephony
Video & Imaging	www.ti.com/video
Wireless	www.ti.com/wireless

Mailing Address: Texas Instruments, Post Office Box 655303, Dallas, Texas 75265
Copyright © 2009, Texas Instruments Incorporated