

Advanced Information

Proximity Capacitive Touch Sensor Controller

MPR121 OVERVIEW

The MPR121 is the second generation sensor controller after the initial release of the MPR03x series devices. The MPR121 will feature increased internal intelligence in addition to Freescale's second generation capacitance detection engine. Some of the major additions include an increased electrode count, a hardware configurable I²C address, an expanded filtering system with debounce, and completely independent electrodes with auto-configuration built in. The device also features a 13th simulated electrode that represents the simultaneous charging of all the electrodes connected together to allow for increased proximity detection in a touch panel or touch screen array.

Features

- 1.71 V to 3.6 V operation
- 29 μ A supply current at 16 ms sample period
- 3 μ A shutdown current
- 12 electrodes
- Continuous independent auto-calibration for each electrode input
- Separate touch and release trip thresholds for each electrode, providing hysteresis and electrode independence
- I²C interface, with $\overline{\text{IRQ}}$ output to advise electrode status changes
- 3 mm x 3 mm x 0.65 mm 20 lead QFN package
- LED driver functionality with 8 shared LEDs
- -40°C to +85°C operating temperature range

Implementations

- Switch Replacements
- Touch Pads

Typical Applications

- PC Peripherals
- MP3 Players
- Remote Controls
- Mobile Phones
- Lighting Controls

MPR121

Capacitive Touch Sensor Controller

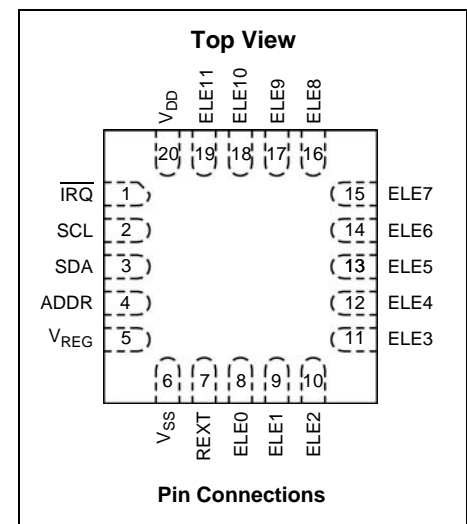
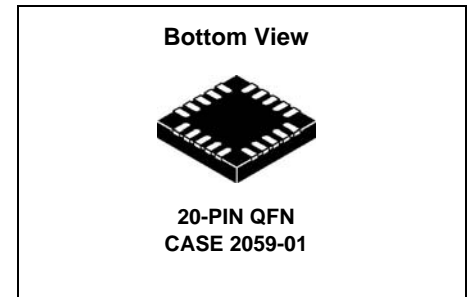

ORDERING INFORMATION					
Device Name	Temperature Range	Case Number	Touch Pads	IRC Address	Shipping
MPR121QR2	-40°C to +85°C	2059 (20-Pin QFN)	12-pads	0x5A - 0x5D	Tape & Reel

This document contains a product under development. Freescale Semiconductor reserves the right to change or discontinue this product without notice.

PIN DESCRIPTION

Pin Description		
Pin No.	Pin Name	Description
1	$\overline{\text{IRQ}}$	Open Collector Interrupt pin
2	SCL	I ² C Clock
3	SDA	I ² C Data
4	ADDR	I ² C Address Select
5	VREG	VREG – 0.1 μ F cap connect
6	VSS	Ground
7	REXT	External Resistor – 75 k Ω
8	ELE0	Electrode 0
9	ELE1	Electrode 1
10	ELE2	Electrode 2
11	ELE3	Electrode 3
12	ELE4 (LED0)	Electrode 4
13	ELE5 (LED1)	Electrode 5
14	ELE6 (LED2)	Electrode 6
15	ELE7 (LED3)	Electrode 7
16	ELE8 (LED4)	Electrode 8
17	ELE9 (LED5)	Electrode 9
18	ELE10 (LED6)	Electrode 10
19	ELE11 (LED7)	Electrode 11
20	VDD	VDD

SCHEMATIC DRAWINGS AND IMPLEMENTATION

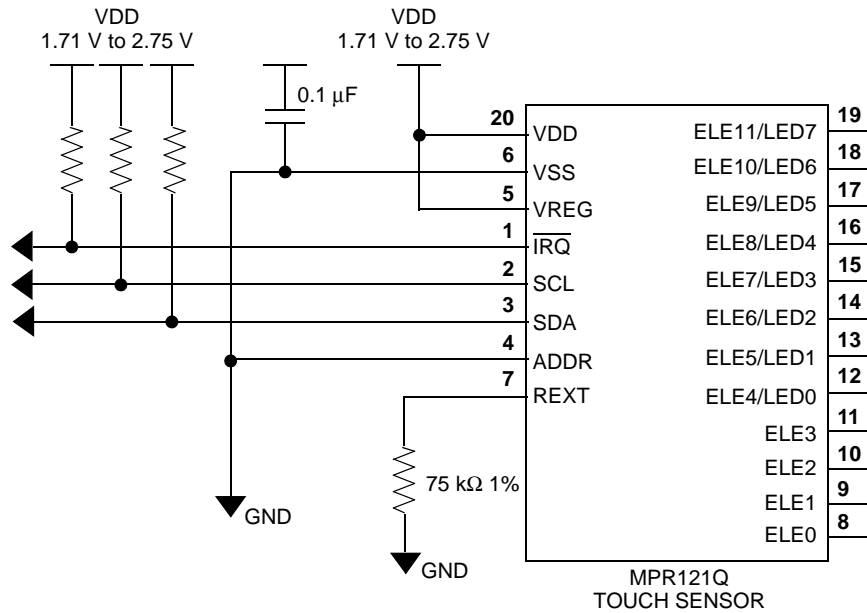

Figure 1. Configuration 1: MPR121 runs from a 1.71 V to 2.75 V supply.

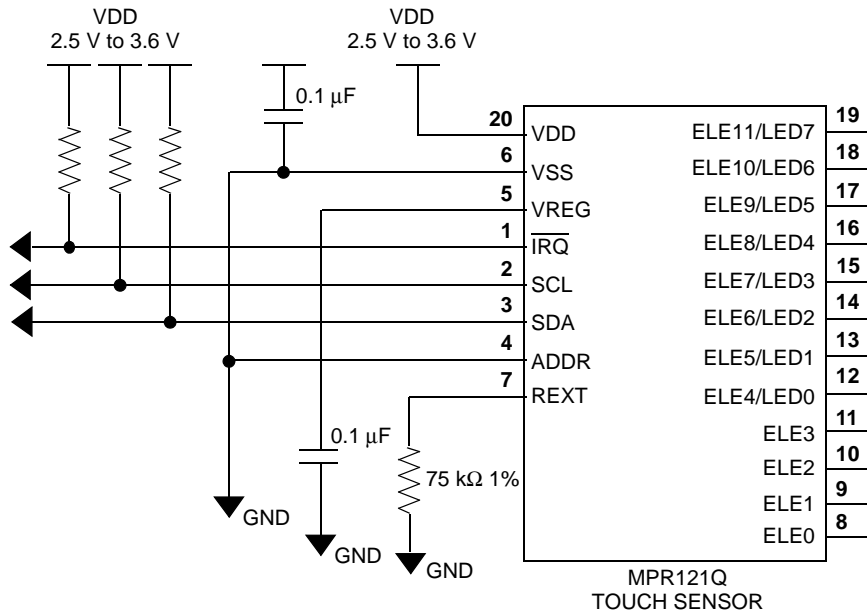

Figure 2. Configuration 2: MPR121 runs from a 2.5 V to 3.6 V supply.

Capacitance Sensing

The MPR121 uses a constant current touch sensor system with two primary types of control. It can measure capacitances ranging from 10 pF to 2000 pF by varying the current and the amount of time supplied to each electrode. The electrodes are controlled independently allowing for a great deal of flexibility in electrode pattern design. To make setup of the device easier, an automatic configuration system can be used to set the ideal capacitance of each electrode. For information on how to set up this system refer to application note AN3889.

Once capacitance is calculated, it runs through a couple of levels of digital filtering allowing for good noise immunity in different environments without sacrificing response time or power consumption. The MPR121 can be configured for sample rates between 1 ms and 128 ms. For information on how to set up this system refer to application note AN3890.

Touch Sensing

Once the capacitance is determined at any given moment, this information must then be translated into intelligent touch recognition. The MPR121 has a couple of systems that have improved over the previous generation in the MPR03x series devices. A baseline tracking system allows the system to track the untouched capacitance in the system. For information on how to set up the baseline capacitance system refer to application note AN3891. The baseline value is then compared with the current value to determine if a touch has occurred. A designer has the ability to set both the rising and falling thresholds in addition to a debounce to eliminate jitter and false touches due to noise. These elements are described in application note AN3892.

Proximity Sensing

A new feature of the MPR121 is the use of a proximity sensing system whereby all of a system's electrodes can be shorted together internally and create a single large electrode. The capacitance of this electrode is larger and projected capacitance can be measured. When enabled, this "13th" electrode will be included at the end of a normal detection cycle and will have its own independent set of configuration registers. This system is described in application note AN3893.

LED Driver

The MPR121 includes eight shared LED driving pins. When these pins are not configured as electrodes, they may be used to drive LEDs. The system allows for both pull up and pull down LED configurations as well as general GPIO push/pull functionality. The configuration of the LED driver system is described in application note AN3894.

Serial Communication

The MPR121 is an Inter-Integrated Circuit (I²C) compliant device with an additional interrupt that is triggered any time a touch or release of a button is detected. The device has a configurable I²C address by connecting the ADDR pin to the VSS, VDD, SDA or SCL lines. The resulting I²C addresses are 0x5A, 0x5B, 0x5C and 0x5D respectively. The specific details of this system are described in AN3895. For reference the register map of the MPR121 is included in [Table 1](#).

Table 1. Register Map

REGISTER	Fields								Register Address	Initial Value	Auto Increment Address
ELE0 - ELE7 Touch Status	ELE7	ELE6	ELE5	ELE4	ELE3	ELE2	ELE1	ELE0	0x00	0x00	Register Address + 1
ELE8 - ELE11, ELEPROX Touch Status	OVCF			ELEPROX	ELE11	ELE10	ELE9	ELE8	0x01	0x00	
ELE0-7 OOR Status	ELE7	ELE6	ELE5	ELE4	ELE3	ELE2	ELE1	ELE0	0x02	0x00	
ELE8-11, ELEPROX OOR Status	ARFF	ACFF		ELEPROX	ELE11	ELE10	ELE9	ELE8	0x03	0x00	
ELE0 Electrode Filtered Data LSB	EFD0LB								0x04	0x00	
ELE0 Electrode Filtered Data MSB								EFD0HB	0x05	0x00	
ELE1 Electrode Filtered Data LSB	EFD1LB								0x06	0x00	
ELE1 Electrode Filtered Data MSB								EFD1HB	0x07	0x00	
ELE2 Electrode Filtered Data LSB	EFD2LB								0x08	0x00	
ELE2 Electrode Filtered Data MSB								EFD2HB	0x09	0x00	
ELE3 Electrode Filtered Data LSB	EFD3LB								0x0A	0x00	
ELE3 Electrode Filtered Data MSB								EFD3HB	0x0B	0x00	
ELE4 Electrode Filtered Data LSB	EFD4LB								0x0C	0x00	
ELE4 Electrode Filtered Data MSB								EFD4HB	0x0D	0x00	
ELE5 Electrode Filtered Data LSB	EFD5LB								0x0E	0x00	
ELE5 Electrode Filtered Data MSB								EFD5HB	0x0F	0x00	
ELE6 Electrode Filtered Data LSB	EFD6LB								0x10	0x00	
ELE6 Electrode Filtered Data MSB								EFD6HB	0x11	0x00	
ELE7 Electrode Filtered Data LSB	EFD7LB								0x12	0x00	
ELE7 Electrode Filtered Data MSB								EFD7HB	0x13	0x00	
ELE8 Electrode Filtered Data LSB	EFD8LB								0x14	0x00	
ELE8 Electrode Filtered Data MSB								EFD8HB	0x15	0x00	
ELE9 Electrode Filtered Data LSB	EFD9LB								0x16	0x00	
ELE9 Electrode Filtered Data MSB								EFD9HB	0x17	0x00	
ELE10 Electrode Filtered Data LSB	EFD10LB								0x18	0x00	
ELE10 Electrode Filtered Data MSB								EFD10HB	0x19	0x00	
ELE11 Electrode Filtered Data LSB	EFD11LB								0x1A	0x00	
ELE11 Electrode Filtered Data MSB								EFD11HB	0x1B	0x00	
ELEPROX Electrode Filtered Data LSB	EFDPROXLB								0x1C	0x00	
ELEPROX Electrode Filtered Data MSB								EFDPROXHB	0x1D	0x00	
ELE0 Baseline Value	E0BV								0x1E	0x00	
ELE1 Baseline Value	E1BV								0x1F	0x00	
ELE2 Baseline Value	E2BV								0x20	0x00	
ELE3 Baseline Value	E3BV								0x21	0x00	
ELE4 Baseline Value	E4BV								0x22	0x00	
ELE5 Baseline Value	E5BV								0x23	0x00	
ELE6 Baseline Value	E6BV								0x24	0x00	
ELE7 Baseline Value	E7BV								0x25	0x00	
ELE8 Baseline Value	E8BV								0x26	0x00	
ELE9 Baseline Value	E9BV								0x27	0x00	
ELE10 Baseline Value	E10BV								0x28	0x00	
ELE11 Baseline Value	E11BV								0x29	0x00	
ELEPROX Baseline Value	EPROXBV								0x2A	0x00	
MHD Rising								MHDR	0x2B	0x00	
NHD Amount Rising								NHDR	0x2C	0x00	
NCL Rising	NCLR								0x2D	0x00	
FDL Rising	FDLR								0x2E	0x00	
MHD Falling								MHDF	0x2F	0x00	
NHD Amount Falling								NHDF	0x30	0x00	

Table 1. Register Map

REGISTER	Fields			Register Address	Initial Value	Auto Increment Address
NCL Falling	NCLF			0x31	0x00	Register Address + 1
FDL Falling	FDLF			0x32	0x00	
NHD Amount Touched			NHDT	0x33	0x00	
NCL Touched	NCLT			0x34	0x00	
FDL Touched	FDLT			0x35	0x00	
ELEPROX MHD Rising			MHDPROXR	0x36	0x00	
ELEPROX NHD Amount Rising			NHDPROXR	0x37	0x00	
ELEPROX NCL Rising	NCLPROXR			0x38	0x00	
ELEPROX FDL Rising	FDLPROXR			0x39	0x00	
ELEPROX MHD Falling			MHDPROXF	0x3A	0x00	
ELEPROX NHD Amount Falling			NHDPROXF	0x3B	0x00	
ELEPROX NCL Falling	NCLPROXF			0x3C	0x00	
ELEPROX FDL Falling	FDLPROXF			0x3D	0x00	
ELEPROX NHD Amount Touched			NHDPROXT	0x3E	0x00	
ELEPROX NCL Touched	NCLPROXT			0x3F	0x00	
ELEPROX FDL Touched	FDLPROXT			0x40	0x00	
ELE0 Touch Threshold	E0TTH			0x41	0x00	
ELE0 Release Threshold	E0RTH			0x42	0x00	
ELE1 Touch Threshold	E1TTH			0x43	0x00	
ELE1 Release Threshold	E1RTH			0x44	0x00	
ELE2 Touch Threshold	E2TTH			0x45	0x00	
ELE2 Release Threshold	E2RTH			0x46	0x00	
ELE3 Touch Threshold	E3TTH			0x47	0x00	
ELE3 Release Threshold	E3RTH			0x48	0x00	
ELE4 Touch Threshold	E4TTH			0x49	0x00	
ELE4 Release Threshold	E4RTH			0x4A	0x00	
ELE5 Touch Threshold	E5TTH			0x4B	0x00	
ELE5 Release Threshold	E5RTH			0x4C	0x00	
ELE6 Touch Threshold	E6TTH			0x4D	0x00	
ELE6 Release Threshold	E6RTH			0x4E	0x00	
ELE7 Touch Threshold	E7TTH			0x4F	0x00	
ELE7 Release Threshold	E7RTH			0x50	0x00	
ELE8 Touch Threshold	E8TTH			0x51	0x00	
ELE8 Release Threshold	E8RTH			0x52	0x00	
ELE9 Touch Threshold	E9TTH			0x53	0x00	
ELE9 Release Threshold	E9RTH			0x54	0x00	
ELE10 Touch Threshold	E10TTH			0x55	0x00	
ELE10 Release Threshold	E10RTH			0x56	0x00	
ELE11 Touch Threshold	E11TTH			0x57	0x00	
ELE11 Release Threshold	E11RTH			0x58	0x00	
ELEPROX Touch Threshold	EPROXTTH			0x59	0x00	
ELEPROX Release Threshold	EPROXRTH			0x5A	0x00	
Debounce Touch & Release		DR		DT	0x5B	0x00
AFE Configuration	FFI		CDC		0x5C	0x10
Filter Configuration	CDT		SFI	ESI	0x5D	0x04
Electrode Configuration	CL	EL		EleEn	0x5E	0x00
ELE0 Electrode Current			CDC0		0x5F	0x00
ELE1 Electrode Current			CDC1		0x60	0x00
ELE2 Electrode Current			CDC2		0x61	0x00

Table 1. Register Map

REGISTER	Fields								Register Address	Initial Value	Auto Increment Address	
ELE3 Electrode Current			CDC3						0x62	0x00	Register Address + 1	
ELE4 Electrode Current			CDC4							0x63		0x00
ELE5 Electrode Current			CDC5							0x64		0x00
ELE6 Electrode Current			CDC6							0x65		0x00
ELE7 Electrode Current			CDC7							0x66		0x00
ELE8 Electrode Current			CDC8							0x67		0x00
ELE9 Electrode Current			CDC9							0x68		0x00
ELE10 Electrode Current			CDC10							0x69		0x00
ELE11 Electrode Current			CDC11							0x6A		0x00
ELEPROX Electrode Current			CDCPROX							0x6B		0x00
ELE0, ELE1 Charge Time			CDT1			CDT0				0x6C		0x00
ELE2, ELE3 Charge Time			CDT3			CDT2				0x6D		0x00
ELE4, ELE5 Charge Time			CDT5			CDT4				0x6E		0x00
ELE6, ELE7 Charge Time			CDT7			CDT6				0x6F		0x00
ELE8, ELE9 Charge Time			CDT9			CDT8				0x70		0x00
ELE10, ELE11 Charge Time			CDT11			CDT10				0x71		0x00
ELEPROX Charge Time						CDTPROX				0x72		0x00
GPIO Control Register 0	CTL011	CTL010	CTL09	CTL08	CTL07	CTL06	CTL05	CTL04	0x73	0x00		
GPIO Control Register 1	CTL111	CTL110	CTL19	CTL18	CTL17	CTL16	CTL15	CTL14	0x74	0x00		
GPIO Data Register	DAT11	DAT10	DAT9	DAT8	DAT7	DAT6	DAT5	DAT4	30x75	0x00		
GPIO Direction Register	DIR11	DIR10	DIR9	DIR8	DIR7	DIR6	DIR5	DIR4	0x76	0x00		
GPIO Enable Register	EN11	EN10	EN9	EN8	EN7	EN6	EN5	EN4	0x77	0x00		
GPIO Data Set Register	SET11	SET10	SET9	SET8	SET7	SET6	SET5	SET4	0x78	0x00		
GPIO Data Clear Register	CLR11	CLR10	CLR9	CLR8	7CLR7	CLR6	CLR5	CLR4	0x79	0x00		
GPIO Data Toggle Register	TOG11	TOG10	TOG9	TOG8	TOG7	TOG6	TOG5	TOG4	0x7A	0x00		
AUTO-CONFIG Control Register 0	AFES		RETRY		BVA		ARE	ACE	0x7B	0x00		
AUTO-CONFIG Control Register 1	SCTS					OORIE	ARFIE	ACFIE	0x7C	0x00		
AUTO-CONFIG USL Register	USL								0x7D	0x00		
AUTO-CONFIG LSL Register	LSL								0x7E	0x00		
AUTO-CONFIG Target Level Register	TL								0x7F	0x00	0x00	

ELECTRICAL CHARACTERISTICS

Absolute Maximum Ratings

Absolute maximum ratings are stress ratings only, and functional operation at the maxima is not guaranteed. Stress beyond the limits specified in Table 2 may affect device reliability or cause permanent damage to the device. For functional operating conditions, refer to the remaining tables in this section. This device contains circuitry protecting against damage due to high static voltage or electrical fields; however, it is advised that normal precautions be taken to avoid application of any voltages higher than maximum-rated voltages to this high-impedance circuit.

Table 2. Absolute Maximum Ratings - Voltage (with respect to V_{SS})

Rating	Symbol	Value	Unit
Supply Voltage	V _{DD}	-0.3 to +3.6	V
Supply Voltage	V _{REG}	-0.3 to +2.75	V
Input Voltage SCL, SDA, $\overline{\text{IRQ}}$	V _{IN}	V _{SS} - 0.3 to V _{DD} + 0.3	V
Operating Temperature Range	T _O	-40 to +85	°C
GPIO Source Current per Pin	i _{GPIO}	12	mA
GPIO Sink Current per Pin	i _{GPIO}	1.2	mA
Storage Temperature Range	T _S	-40 to +125	°C

ESD AND LATCH-UP PROTECTION CHARACTERISTICS

Normal handling precautions should be used to avoid exposure to static discharge.

Qualification tests are performed to ensure that these devices can withstand exposure to reasonable levels of static without suffering any permanent damage. During the device qualification ESD stresses were performed for the Human Body Model (HBM), the Machine Model (MM) and the Charge Device Model (CDM).

A device is defined as a failure if after exposure to ESD pulses the device no longer meets the device specification. Complete DC parametric and functional testing is performed per the applicable device specification at room temperature followed by hot temperature, unless specified otherwise in the device specification.

Table 3. ESD and Latch-up Test Conditions

Rating	Symbol	Value	Unit
Human Body Model (HBM)	V _{ESD}	±2000	V
Machine Model (MM)	V _{ESD}	±200	V
Charge Device Model (CDM)	V _{ESD}	±500	V
Latch-up current at T _A = 85°C	I _{LATCH}	±100	mA

DC CHARACTERISTICS

This section includes information about power supply requirements and I/O pin characteristics.

Table 4. DC Characteristics

(Typical Operating Circuit, V_{DD} and $V_{REG} = 1.8\text{ V}$, $T_A = 25^\circ\text{C}$, unless otherwise noted.)

Parameter	Symbol	Conditions	Min	Typ	Max	Units
High Supply Voltage	V_{DD}		2.0	3.3	3.6	V
Low Supply Voltage	V_{REG}		1.71	1.8	2.75	V
Average Supply Current	I_{DD}	Run1 Mode @ 1 ms sample period		393		μA
Average Supply Current	I_{DD}	Run1 Mode @ 2 ms sample period		199		μA
Average Supply Current	I_{DD}	Run1 Mode @ 4 ms sample period		102		μA
Average Supply Current	I_{DD}	Run1 Mode @ 8 ms sample period		54		μA
Average Supply Current	I_{DD}	Run1 Mode @ 16 ms sample period		29		μA
Average Supply Current	I_{DD}	Run1 Mode @ 32 ms sample period		17		μA
Average Supply Current	I_{DD}	Run1 Mode @ 64 ms sample period		11		μA
Average Supply Current	I_{DD}	Run1 Mode @ 128 ms sample period		8		μA
Measurement Supply Current	I_{DD}	Peak of measurement duty cycle		1		mA
Idle Supply Current	I_{DD}	Stop Mode		3		μA
Input Leakage Current ELE_	I_{IH}, I_{IL}			0.025		μA
Input Capacitance ELE_					15	pF
Input High Voltage SDA, SCL	V_{IH}		$0.7 \times V_{DD}$			V
Input Low Voltage SDA, SCL	V_{IL}				$0.3 \times V_{DD}$	V
Input Leakage Current SDA, SCL	I_{IH}, I_{IL}			0.025	1	μA
Input Capacitance SDA, SCL					7	pF
Output Low Voltage SDA, IRQ	V_{OL}	$I_{OL} = 6\text{ mA}$			0.5V	V
Output High Voltage ELE4 - ELE11 (GPIO mode)	V_{OHGPIO}	$V_{DD} = 2.7\text{ V to } 3.6\text{ V}: I_{OHGPIO} = -10\text{ mA}$ $V_{DD} = 2.3\text{ V to } 2.7\text{ V}: I_{OHGPIO} = -6\text{ mA}$ $V_{DD} = 1.8\text{ V to } 2.3\text{ V}: I_{OHGPIO} = -3\text{ mA}$	$V_{DD} - 0.5$			V
Output Low Voltage ELE4 - ELE11 (GPIO mode)	V_{OLGPIO}	$I_{OLGPIO} = 1\text{ mA}$			0.5	V
Power On Reset	V_{TLH}	V_{DD} rising	1.08	1.35	1.62	V
	V_{THL}	V_{DD} falling	0.88	1.15	1.42	V

AC CHARACTERISTICS

Table 5. AC CHARACTERISTICS

(Typical Operating Circuit, V_{DD} and $V_{REG} = 1.8\text{ V}$, $T_A = 25^\circ\text{C}$, unless otherwise noted.)

Parameter	Symbol	Conditions	Min	Typ	Max	Units
8 MHz Internal Oscillator	f_H		7.44	8	8.56	MHz
1 kHz Internal Oscillator	f_L		0.65	1	1.35	kHz

I²C AC CHARACTERISTICS

Table 6. I²C AC Characteristics

(Typical Operating Circuit, V_{DD} and V_{REG} = 1.8 V, T_A = 25°C, unless otherwise noted.)

Parameter	Symbol	Conditions	Min	Typ	Max	Units
Serial Clock Frequency	f _{SCL}				400	kHz
Bus Free Time Between a STOP and a START Condition	t _{BUF}		1.3			μs
Hold Time, (Repeated) START Condition	t _{HD, STA}		0.6			μs
Repeated START Condition Setup Time	t _{SU, STA}		0.6			μs
STOP Condition Setup Time	t _{SU, STO}		0.6			μs
Data Hold Time	t _{HD, DAT}				0.9	μs
Data Setup Time	t _{SU, DAT}		100			ns
SCL Clock Low Period	t _{LOW}		1.3			μs
SCL Clock High Period	t _{HIGH}		0.7			μs
Rise Time of Both SDA and SCL Signals, Receiving	t _R			20+0.1C _b	300	ns
Fall Time of Both SDA and SCL Signals, Receiving	t _F			20+0.1C _b	300	ns
Fall Time of SDA Transmitting	t _{F, TX}			20+0.1C _b	250	ns
Pulse Width of Spike Suppressed	t _{SP}			25		ns
Capacitive Load for Each Bus Line	C _b				400	pF

AN3889: MPR121 Capacitance Sensing Settings

INTRODUCTION

Touch acquisition takes a few different parts of the system in order to detect touch. The first stage of this process is to capture the pad capacitance. Freescale's MPR121 utilizes the principle that a capacitor holds a fixed amount of charge at a specific electric potential. Both the implementation and the configuration will be described in this application note.

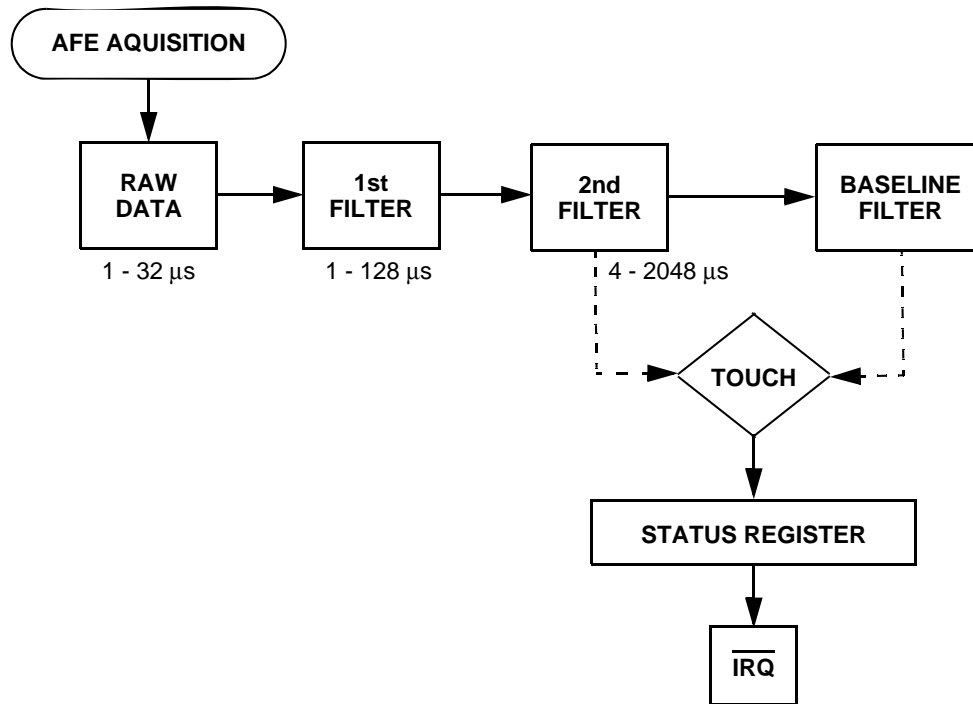

Figure 3. Data Flow in the MPR121

CAPACITANCE MEASUREMENT

The basic measurement technique used by the MPR121 is to charge up the capacitor C on one electrode input with a DC current I for a time T (the charge time). Before measurement, the electrode input is grounded, so the electrode voltage starts from 0 V and charges up with a slope, Equation 1, where C is the pad capacitance on the electrode (Figure 4). All of the other electrodes are grounded during this measurement. At the end of time T , the electrode voltage is measured with a 10 bit ADC. The voltage is inversely proportional to capacitance according to Equation 2. The electrode is then discharged back to ground at the same rate it was charged.

$$\frac{dV}{dt} = \frac{I}{C} \quad \text{Equation 1}$$

$$V = \frac{I \times T}{C} \quad \text{Equation 2}$$

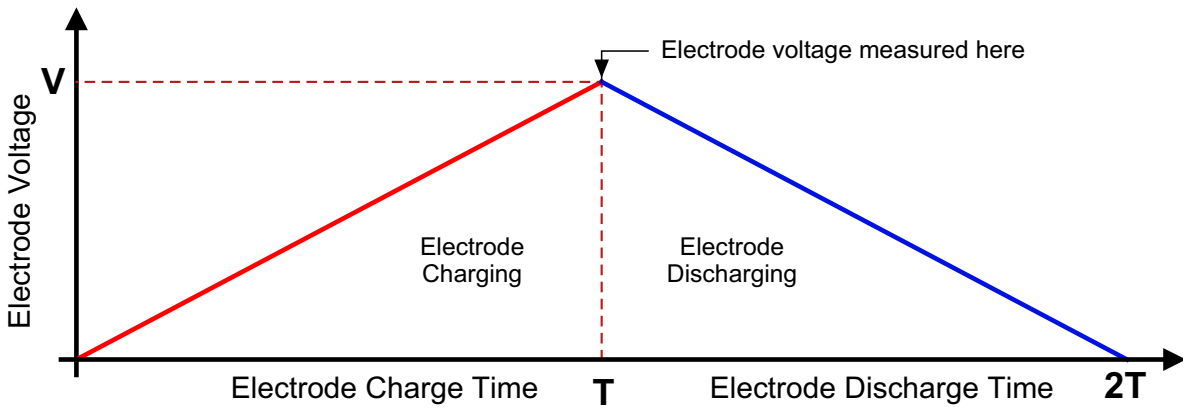

Figure 4. MPR121 Electrode Measurement Charging Pad Capacitance

When measuring capacitance there are some inherent restrictions due to the methodology used. On the MPR121 the voltage after charging must be in the range that is shown in [Figure 5](#).

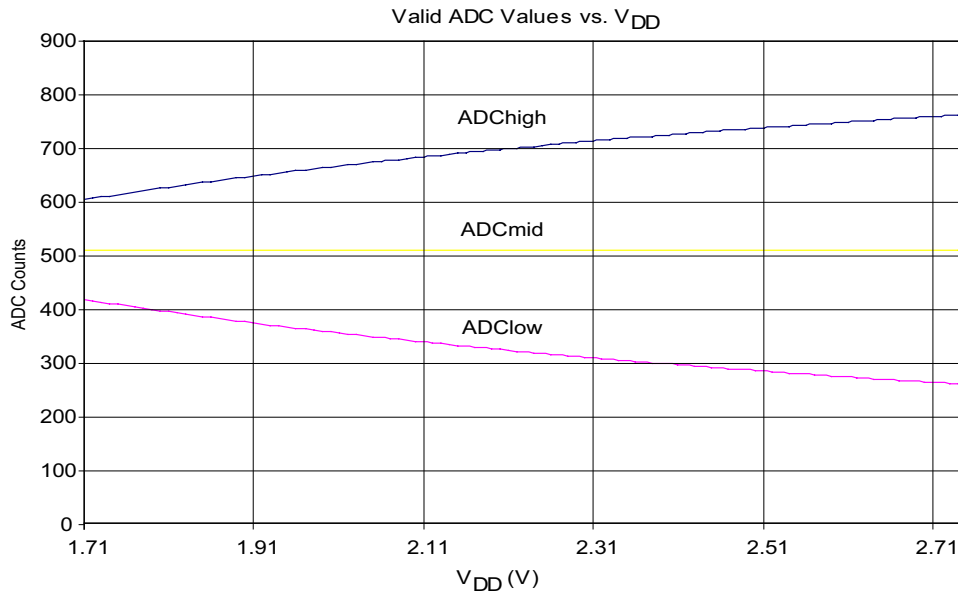

Figure 5.

The valid operating range of the electrode charging source is 0.7 V to $(V_{DD} - 0.7 \text{ V})$. This means that for a given V_{DD} the valid ADC (voltage visible to the digital interface) range is given by

$$ADC_{low} = \frac{0.7}{V_{DD}}(1024), \quad \text{Equation 3}$$

and

$$ADC_{high} = \frac{V_{DD} - 0.7}{V_{DD}}(1024). \quad \text{Equation 4}$$

These equations are represented in the graph. In the nominal case of $V_{DD} = 1.8 \text{ V}$ the ADC range is shown below in [Table 7](#).

Table 7.

V_{DD}	ADC_{high}	ADC_{low}	ADC_{mid}
1.8	625.7778	398.2222	512

Any ADC counts outside of the range shown are invalid and settings must be adjusted to be within this range. If capacitance variation is of importance for an application after the current output, charge time and supply voltage are determined then the following equations can be used. The valid range for capacitance is calculated by using the minimum and maximum ADC values in the capacitance equation. Substituting the low and high ADC equations into the capacitance equation yields the equations for the minimum and maximum capacitance values which are

$$C_{low} = \frac{I \times T}{V_{DD}^{-0.7}} \quad \text{and} \quad C_{high} = \frac{I \times T}{0.7} . \quad \text{Equation 5}$$

SENSITIVITY

The sensitivity of the MPR121 is relative to the capacitance range being measured. Given the ADC value, current and time and settings capacitance can be calculated,

$$C = \frac{I \times T \times 1024}{V_{DD} \times ADC} . \quad \text{Equation 6}$$

For a given capacitance the sensitivity can be measured by taking the derivative of this equation. The result of this is the following equation, representing the change in capacitance per one ADC count, where the ADC in the equation represents the current value.

$$\frac{dC}{dADC} = \frac{I \times T \times 1024}{V_{DD} \times ADC^2} \quad \text{Equation 7}$$

This relationship is shown in the following graph by taking the midpoints off all possible ranges by varying the current and time settings. The midpoint is assumed to be 512 for ADC and the nominal supply voltage of 1.8 V is used.

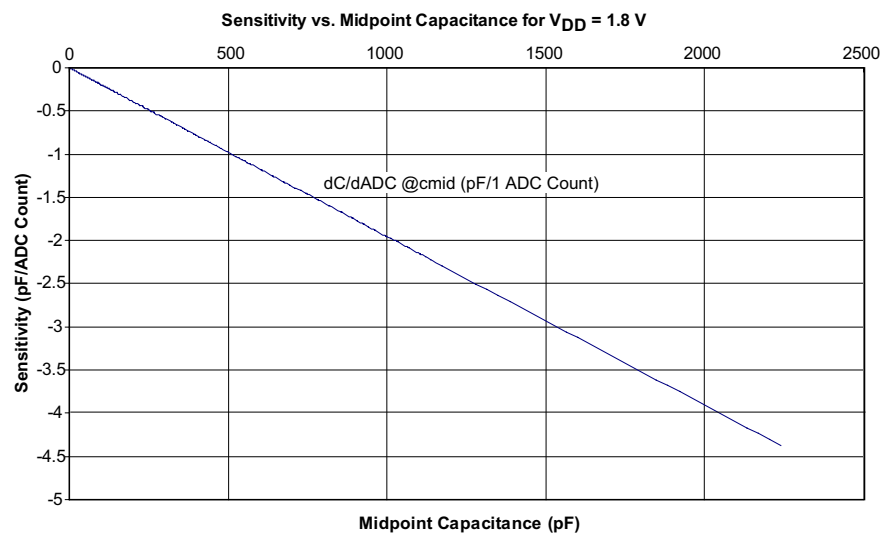

Figure 6.

Smaller amounts of change indicate increased sensitivity for the capacitance sensor. Some sample values are shown in Table 8.

Table 8.

pF	Sensitivity (pF/ADC count)
10	-0.01953
100	-0.19531

In the previous cases, the capacitance is assumed to be in the middle of the range for specific settings. Within the capacitance range the equation is nonlinear, thus the sensitivity is best with the lowest capacitance. This graph shows the sensitivity derivative reading across the valid range of capacitances for a set I, T, and V_{DD} . For simple small electrodes (that are approximately 21 pF) and a nominal 1.8 V supply. Figure 7 is representative of this effect.

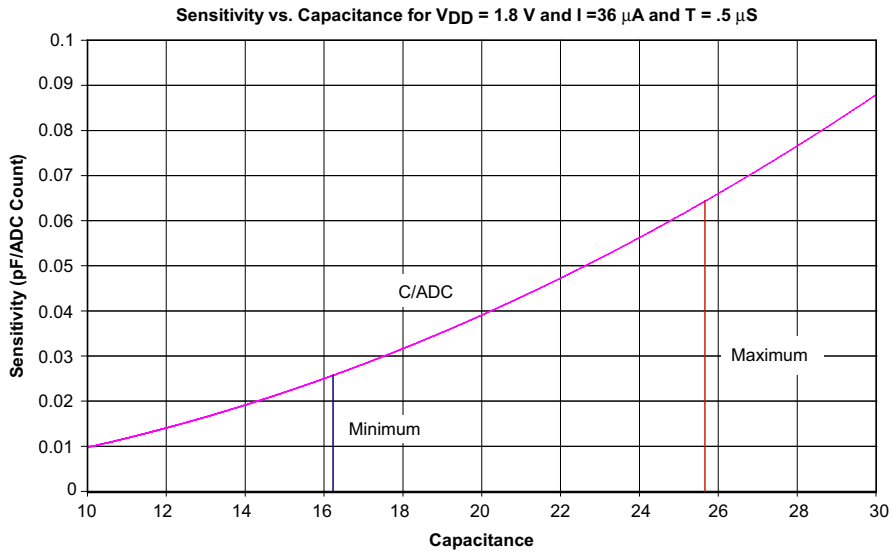

Figure 7.

CONFIGURATION

From the implementation above, there are two elements that can be configured to yield a wide range of capacitance readings ranging from 0.455 pF to 2874.39 pF. The two configurable components are the electrode charge current and the electrode charge time. The electrode charge current can be configured to equal a range of values between 1 μA and 63 μA . This value is set in the Charge Discharge Current (CDC) in the Analog Front End AFE Configuration register. The electrode charge time can be configured to equal a range of values between 500 ns and 32 μs . This value is set in the Charge Discharge Time (CDT) in the Filter Configuration Register.

AFE CONFIGURATION REGISTER

The AFE Configuration Register is used to set both the CDC and the number of samples taken in the lowest level filter. The address of the AFE Configuration Register is 0x5C.

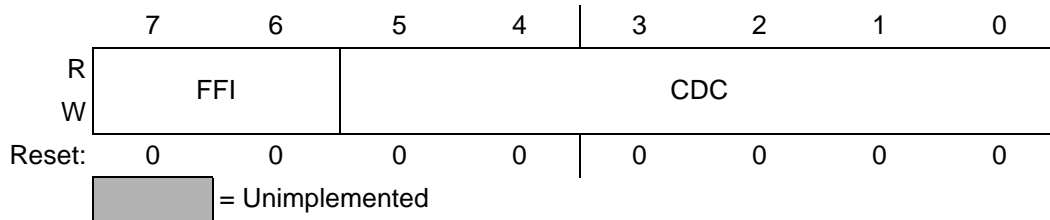

Figure 8. AFE Configuration Register

Table 9. AFE Configuration Register Field Descriptions

Field	Description
7:6 FFI	First Filter Iterations – The first filter iterations field selects the number of samples taken as input to the first level of filtering. 00 Encoding 0 – Sets samples taken to 6 01 Encoding 1 – Sets samples taken to 10 10 Encoding 2 – Sets samples taken to 18 11 Encoding 3 – Sets samples taken to 34
5:0 CDC	Charge Discharge Current – The Charge Discharge Current field selects the supply current to be used when charging and discharging an electrode. 000000 Encoding 0 – Disables Electrode Charging 000001 Encoding 1 – Sets the current to 1 μA ~ 111111 Encoding 63 – Sets the current to 63 μA

FILTER CONFIGURATION REGISTER

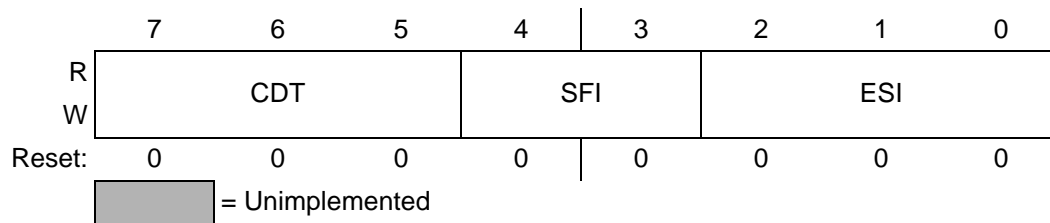

Figure 9. Filter Configuration Register

Table 10. Filter Configuration Register Field Descriptions

Field	Description
7:5 CDT	Charge Discharge Time – The Charge Discharge Time field selects the amount of time an electrode charges and discharges. 000 Encoding 0 – Invalid 001 Encoding 1 – Time is set to 0.5 μ s 010 Encoding 2 – Time is set to 1 μ s ~ 111 Encoding 7 – Time is set to 32 μ s.
4:3 SFI	Second Filter Iterations – The Second Filter Iterations field selects the number of samples taken for the second level filter. 00 Encoding 0 – Number of samples is set to 4 01 Encoding 1 – Number of samples is set to 6 10 Encoding 2 – Number of samples is set to 10 11 Encoding 3 – Number of samples is set to 18
2:0 ESI	Electrode Sample Interval – The Electrode Sample Interval field selects the period between samples used for the second level of filtering. 000 Encoding 0 – Period set to 1 ms 001 Encoding 1 – Period set to 2 ms ~ 111 Encoding 7 – Period set to 128 ms

The SFI, ESI and FFI are described in AN3890. In addition to these global (same for all electrodes) settings, the MPR121 electrodes can also be independently configured.

ELECTRODE CHARGE CURRENT REGISTER

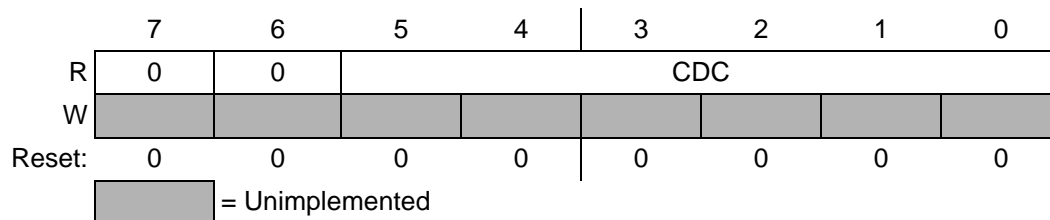

Figure 10. Electrode Charge Current Register

Table 11. Electrode Charge Current Register Field Descriptions

Field	Description
5:0 CDC	Electrode # Charge Discharge Current – The Charge Discharge Current field selects the supply current to be used when charging and discharging an electrode. 000000 Encoding 0 – Disables Electrode Charging 000001 Encoding 1 – Sets the current to 1 μ A ~ 111111 Encoding 63 – Sets the current to 63 μ A

ELECTRODE CHARGE TIME

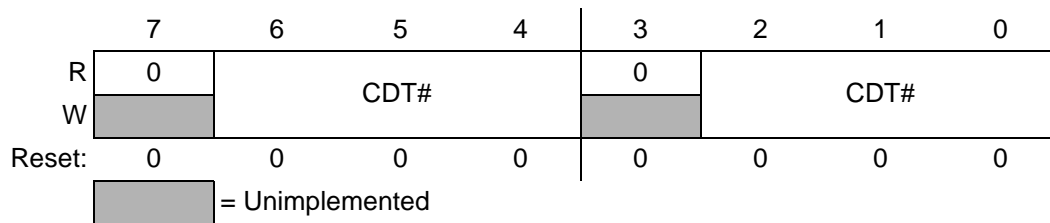

Figure 11. Electric Charge Time Register

Table 12. Electrode Charge Time Register Field Descriptions

Field	Description
6:4 CDT#	Electrode # Charge Discharge Time – The Charge Discharge Time field selects the amount of time an electrode charges and discharges. 000 Encoding 0 – Global value is used. 001 Encoding 1 – Time is set to 0.5 μ s 010 Encoding 2 – Time is set to 1 μ s ~ 11 Encoding 7 – Time is set to 32 μ s.
2:0 CDT#	Electrode # Charge Discharge Time – The Charge Discharge Time field selects the amount of time an electrode charges and discharges. 000 Encoding 0 – Global value is used. 001 Encoding 1 – Time is set to 0.5 μ s 010 Encoding 2 – Time is set to 1 μ s ~ 11 Encoding 7 – Time is set to 32 μ s.

AUTO-CONFIGURATION

One of the new features added in the MPR121 that was not included in the MPR03X is the ability to automatically configure the Charge Current the Charge Time. This eliminates much of the guess involved with touch sensors and allows the same settings to properly configure the device for a wide range of application and electrodes. As show earlier in this document, the sensitivity of the sensor is maximized by having the baseline be as high as possible for a specific baseline capacitance. The restriction on the high side is that a system should not charge above $V_{DD} - 0.7$ V due to this being a non-linear region. Thus the target voltage used is approximately $V_{DD} - 0.7$ V.

Table 13.

Voltage (V_{DD})	$V_{DD} - 0.7$ V	ADC	Baseline
1.8 V	1.1 V	625	156
V_{DD}	2.3 V	785	196

This implies that the automatic configuration system should target approximately 156 when V_{DD} is 1.8 V and 196 when V_{DD} is 3.0 V. The following three registers should be set based on the V_{DD} in the system. If the voltage is unregulated, set the values assuming the lowest voltage necessary for the battery. If the final voltage supply in the system is not known, just use the 1.8 V values as they represent the worst case. This lower setting will not dramatically affect the performance, thus the 1.8 V could be considered default and be used in all cases where fine tuning is not required.

AUTO-CONFIG USL REGISTER

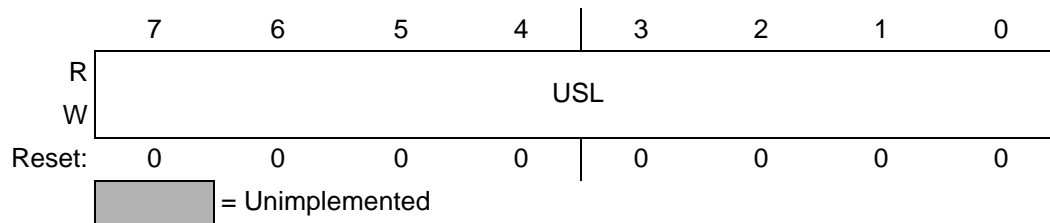

Figure 12. AUTO-CONFIG USL Register

Table 14. AUTO-CONFIG USL Register Field Descriptions

Field	Description
7:0 USL	Upper Limit – The Upper Limit for the auto-configuration baseline search is set to this value. 00000000 – Upper Limit set to 0 00000001 – Upper Limit set to 1 ~ 11111111 – Upper Limit set to 255

As this register represents the upper limit for the auto-configuration the value can be calculated by:

$$VSL = \frac{V_{DD} - 0.7}{V_{DD}} \cdot 256 \quad \text{Equation 8}$$

For the 1.8 V system, this value is 156 or 0x9C.

AUTO-CONFIG TARGET LEVEL REGISTER

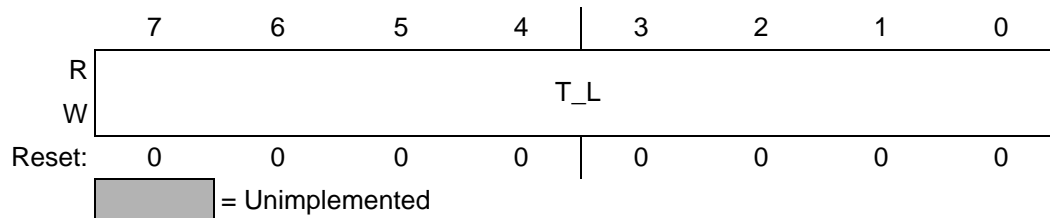

Figure 13. AUTO-CONFIG Target Level Register

Table 15. AUTO-CONFIG Target Level Register Field Descriptions

Field	Description
7:0 TL	Target Level – The Target Level for the auto-configuration baseline search is set to this value. 00000000 – Target Level set to 0 00000001 – Target Level set to 1 ~ 11111111 – Target Level set to 255

This register represents the target level for the auto-configuration. The value can be calculated by:

$$Target = \frac{V_{DD} - 0.7}{V_{DD}} \cdot 256 \cdot 0.9$$

← 90% of USL

For a 1.8 V system, this value is 140 or 0x8C.

AUTO-CONFIG LSL REGISTER

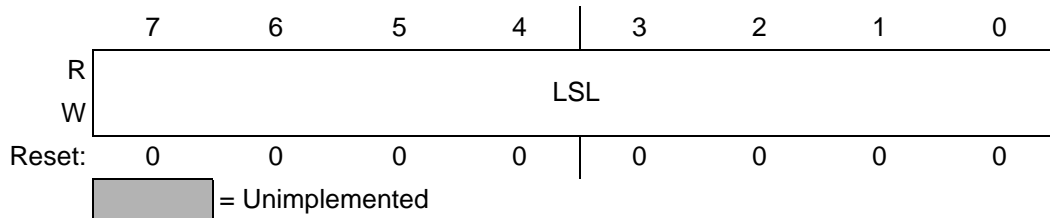

Figure 14. AUTO-CONFIG LSL Register

Table 16. AUTO-CONFIG LSL Register Field Descriptions

Field	Description
7:0 LSL	Lower Limit – The Lower Limit for the auto-configuration baseline search is set to this value. 00000000 – Lower Limit set to 0 00000001 – Lower Limit set to 1 ~ 11111111 – Lower Limit set to 255

This register represents the lower limit for the auto-configuration. The value can be calculated by:

$$Target = \frac{V_{DD} - 0.7}{V_{DD}} \cdot 256 \cdot 0.65$$

← 65% of USL

For a 1.8 V system, this value is 101 or 0x65.

The last setting required to set up the auto-configuration system is the AUTO e Register.

AUTO-CONFIG CONTROL REGISTER

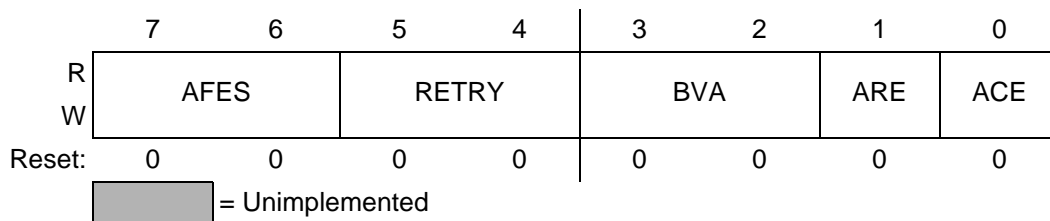

Figure 15. AUTO-CONFIG Control Register

Table 17. AUTO-CONFIG Control Register Field Descriptions

Field	Description
7:6 AFES	First Filter Iterations – The first filter iterations field selects the number of samples taken as input to the first level of filtering. This value must match the FFI set in the AFE Configuration register for proper AUTO-CONFIG functionality. 00 Encoding 0 – Sets samples taken to 6 01 Encoding 1 – Sets samples taken to 10 10 Encoding 2 – Sets samples taken to 18 11 Encoding 3 – Sets samples taken to 34
5:4 RETRY	Retry – The Retry value determines under what circumstances the auto-configuration system will retry. 00 – Retry disabled 01 – Retry enabled 10 – Retry enabled 11 – Retry enabled
3:2 BVA	Baseline Value Adjust – The baseline value adjust determines the initial value of the baseline registers after auto-configuration completes. 00 – Baseline is not changed 01 – Baseline is cleared 10 – Baseline is set to the AUTO-CONFIG baseline with the lower 3 bits cleared 11 – Baseline is set to the AUTO-CONFIG baseline
1 ARE	Automatic Reconfiguration Enable – The automatic reconfiguration enable, enables or disables automatic reconfiguration. 0 – ARE is disabled 1 – ARE is enabled
0 ACE	Automatic Configuration Enable – The automatic configuration enable, enables or disables automatic configuration. 0 – ACE is disabled 1 – ACE is enabled

The normal setup of the system is to set this register to 0x0B or 0b00001011. This means that the FFI is 00, but if the FFI in the AFE Configuration Register is different, it must be changed to match. For a description of this register, please refer to AN3890. The RETRY is disabled because in production systems, this will not be required. The BVA is set to 10 which allows the baseline to be updated. 10 is used instead of 11 because this guarantees that the baseline will be lower than the data. This is preferable as it protects against false touches. If somehow the baseline started higher than the data, a touch would be triggered and the detection system would have to be reset to work correctly. Last, both the automatic configuration and automatic reconfiguration are enable. Reconfiguration will trigger any time the baseline drifts outside the range set by the USL and the LSL.

There is also a set of flags which show when the automatic configuration has failed. For normal sized touch electrodes, this cannot occur without the USL, LSL and TSL being incorrectly set. The most likely configuration error is to set the USL (upper limit) at a lower value than the LSL (lower limit). Thus, as the algorithm searches for settings that work, it would always result in a fail throwing the OOR (Out Of Range) status flag.

The ARFF and ACFF also tell the user which type of configuration cycle caused the error. If it was triggered during an initial calibration, the ACFF will trigger. If the fail occurs during a reconfiguration, the ARFF will trigger.

ELE0-7 OUT OF RANGE STATUS REGISTER

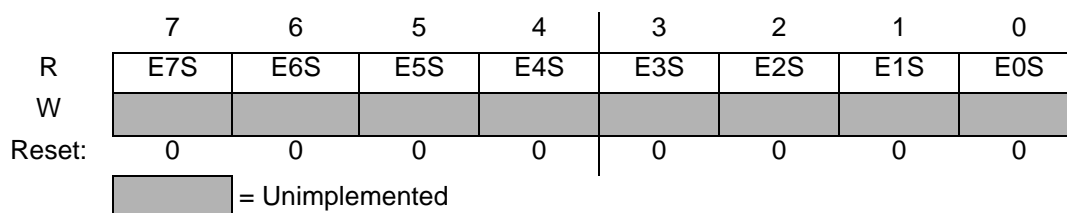

Figure 16. ELE0-7 Out Of Range Status Register

Table 18. ELE0-7 Out Of Range Status Register Field Descriptions

Field	Description
7 E7S	Electrode 7 OOR Status – The Electrode 7 OOR Status shows if the AUTO-CONFIG has failed. 0 – Auto-configuration Successful 1 – Auto-configuration Failed
6 E6S	Electrode 6 OOR Status – The Electrode 7 OOR Status shows if the AUTO-CONFIG has failed. 0 – Auto-configuration Successful 1 – Auto-configuration Failed
5 E5S	Electrode 5 OOR Status – The Electrode 7 OOR Status shows if the AUTO-CONFIG has failed. 0 – Auto-configuration Successful 1 – Auto-configuration Failed
4 E4S	Electrode 4 OOR Status – The Electrode 7 OOR Status shows if the AUTO-CONFIG has failed. 0 – Auto-configuration Successful 1 – Auto-configuration Failed
3 E3S	Electrode 3 OOR Status – The Electrode 7 OOR Status shows if the AUTO-CONFIG has failed. 0 – Auto-configuration Successful 1 – Auto-configuration Failed
2 E2S	Electrode 2 OOR Status – The Electrode 7 OOR Status shows if the AUTO-CONFIG has failed. 0 – Auto-configuration Successful 1 – Auto-configuration Failed
1 E1S	Electrode 1 OOR Status – The Electrode 7 OOR Status shows if the AUTO-CONFIG has failed. 0 – Auto-configuration Successful 1 – Auto-configuration Failed
0 E0S	Electrode 0 OOR Status – The Electrode 7 OOR Status shows if the AUTO-CONFIG has failed. 0 – Auto-configuration Successful 1 – Auto-configuration Failed

ELE8-11, ELEPROX OUT OF RANGE STATUS REGISTER

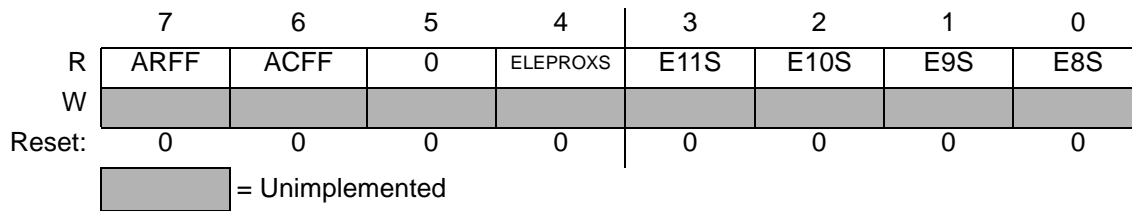

Figure 17. ELE8-11, ELEPROX Out Of Range Status Register

Table 19. ELE8-11, ELEPROX Out Of Range Status Register Field Descriptions

Field	Description
7 ARFF	Automatic Reconfiguration Fail Flag – The Automatic Reconfiguration Fail Flag shows is the OOR was triggered during a reconfiguration cycle. 0 – Auto-reconfiguration did not cause the OOR flag 1 – Auto-reconfiguration did cause the OOR flag
6 ACFF	Automatic Configuration Fail Flag – The Automatic Configuration Fail Flag shows is the OOR was triggered during an initial configuration cycle. 0 – Auto-configuration did not cause the OOR flag 1 – Auto-configuration did cause the OOR flag
4 ELEPROXS	Electrode PROX OOR Status – The Electrode PROX OOR Status shows if the AUTO-CONFIG has failed. 0 – Auto-configuration Successful 1 – Auto-configuration Failed
3 E11S	Electrode 11 OOR Status – The Electrode 11 OOR Status shows if the AUTO-CONFIG has failed. 0 – Auto-configuration Successful 1 – Auto-configuration Failed
2 E10S	Electrode 10 OOR Status – The Electrode 10 OOR Status shows if the AUTO-CONFIG has failed. 0 – Auto-configuration Successful 1 – Auto-configuration Failed
1 E9S	Electrode 9 OOR Status – The Electrode 9 OOR Status shows if the AUTO-CONFIG has failed. 0 – Auto-configuration Successful 1 – Auto-configuration Failed
0 E8S	Electrode 8 OOR Status – The Electrode 8 OOR Status shows if the AUTO-CONFIG has failed. 0 – Auto-configuration Successful 1 – Auto-configuration Failed

AN3890: MPR121 Capacitance Sensing — Filtering and Timing

INTRODUCTION

The capacitance sensing front end of the MPR121 produces data at extremely high rates, which significantly improves the capabilities of a filtering system. The capacitance engine described in AN3889 act on a $1\ \mu\text{s}$ - $32\ \mu\text{s}$ per sample data rate. This application note will discuss the first and second level filters in the MPR121 and how they impact timing and power consumption.

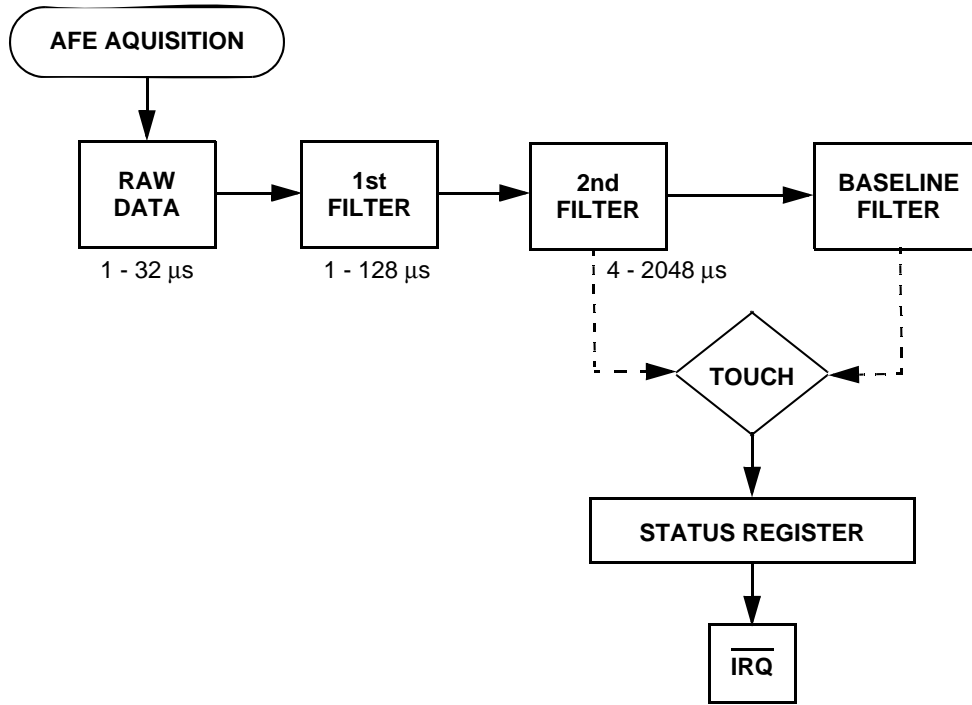

Figure 18. Data Flow in the MPR121

The first level filter is configured through the use of the First Filter Iterations (FFI) and the Charge Discharge Time (CDT).

AFE CONFIGURATION REGISTER

The AFE Configuration Register is used to set both the CDC and the number of samples taken in the lowest level filter. The address of the AFE Configuration Register is 0x5C.

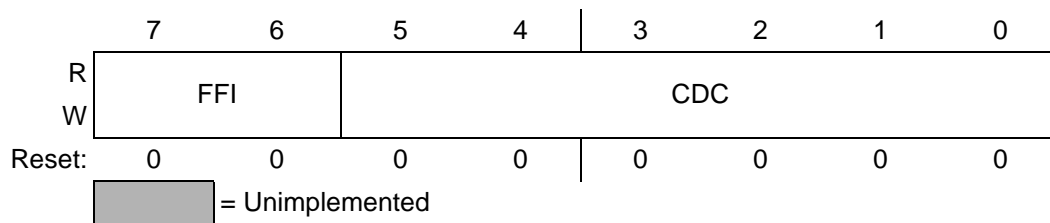

Figure 19. AFE Configuration Register

Table 20. AFE Configuration Register Field Descriptions

Field	Description
7:6 FFI	First Filter Iterations – The first filter iterations field selects the number of samples taken as input to the first level of filtering. 00 Encoding 0 – Sets samples taken to 6 01 Encoding 1 – Sets samples taken to 10 10 Encoding 2 – Sets samples taken to 18 11 Encoding 3 – Sets samples taken to 34
5:0 CDC	Charge Discharge Current – The Charge Discharge Current field selects the supply current to be used when charging and discharging an electrode. 000000 Encoding 0 – Disables Electrode Charging 000001 Encoding 1 – Sets the current to 1µA ~ 111111 Encoding 63 – Sets the current to 63 µA

The properties of the filter are determined by these two settings, but the CDT is determined by the capacitance being measured, as discussed in AN3889. The FFI sets the number of samples being measured. The result of an FFI setting of 6 or 0x00 would be to take 6 samples, toss the maximum and minimum, then average the remaining 4 samples. The results of an oscilloscope output on an electrode with the setting of FFI = 0x00 and CDT is shown in Figure 20.

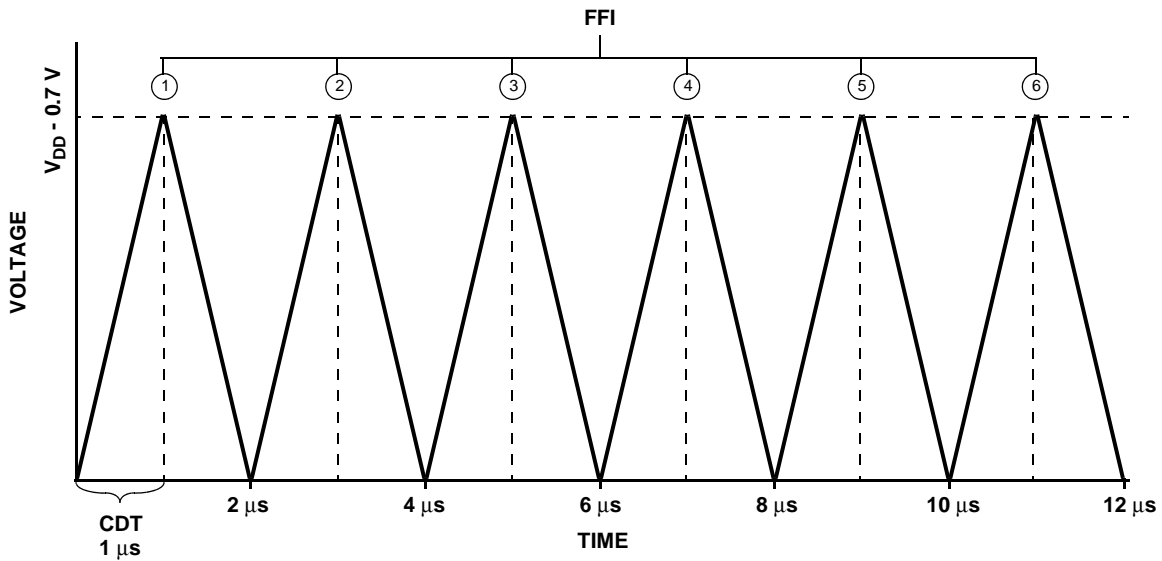

Figure 20.

The first level of filtering delivers data to a second filter stage. The second filter stage averages samples over more time, in this example anywhere from 1 ms to 128 ms. Then a value can be selected for how many samples should be averaged.

FILTER CONFIGURATION REGISTER

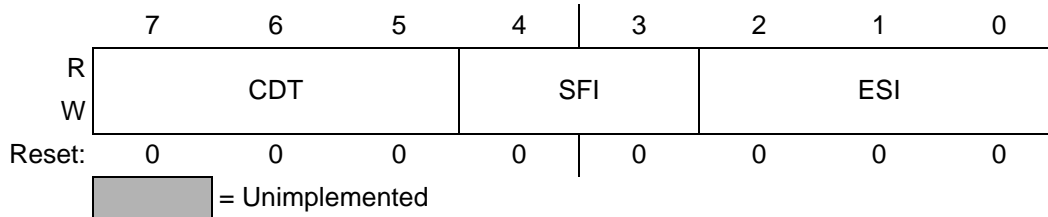

Figure 21. Filter Configuration Register

Table 21. Filter Configuration Register Field Descriptions

Field	Description
7:5 CDT	Charge Discharge Time – The Charge Discharge Time field selects the amount of time an electrode charges and discharges. 000 Encoding 0 – Invalid 001 Encoding 1 – Time is set to 0.5 μ s 010 Encoding 2 – Time is set to 1 μ s ~ 111 Encoding 7 – Time is set to 32 μ s.
4:3 SFI	Second Filter Iterations – The Second Filter Iterations field selects the number of samples taken for the second level filter. 00 Encoding 0 – Number of samples is set to 4 01 Encoding 1 – Number of samples is set to 6 10 Encoding 2 – Number of samples is set to 10 11 Encoding 3 – Number of samples is set to 18
2:0 ESI	Electrode Sample Interval – The Electrode Sample Interval field selects the period between samples used for the second level of filtering. 000 Encoding 0 – Period set to 1 ms 001 Encoding 1 – Period set to 2 ms ~ 111 Encoding 7 – Period set to 128 ms

Note: In most cases the CDT in this register is not used. It will normally be auto-configured as described in AN3889

While the 1 ms to 128 ms does affect the filtering, the main purposed of adjusting the sample rate would be to change the average current consumption of the device. [Figure 22](#) illustrates this adjustment.

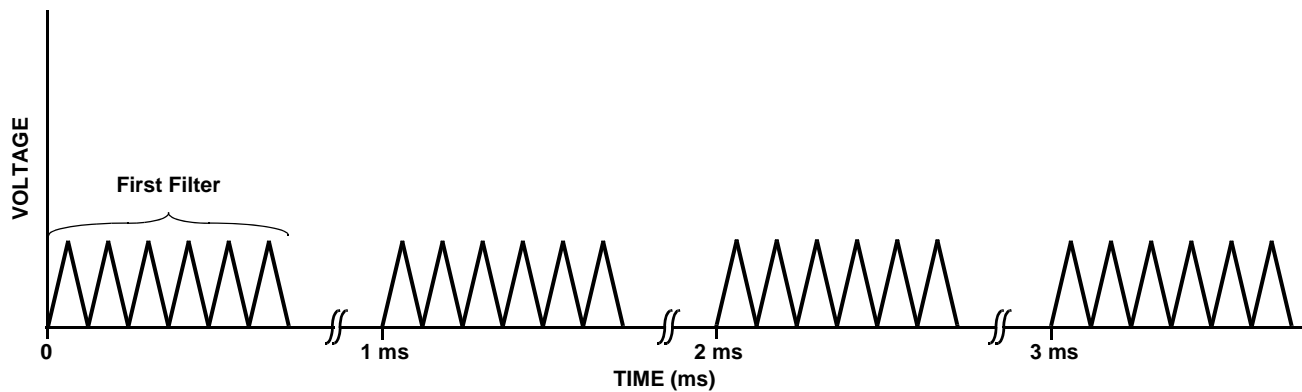

Figure 22.

From this, it can be seen that the 12 μ s up time from the 1 ms samples results in a very low percent of duty cycle. This results in a very low average current consumption.

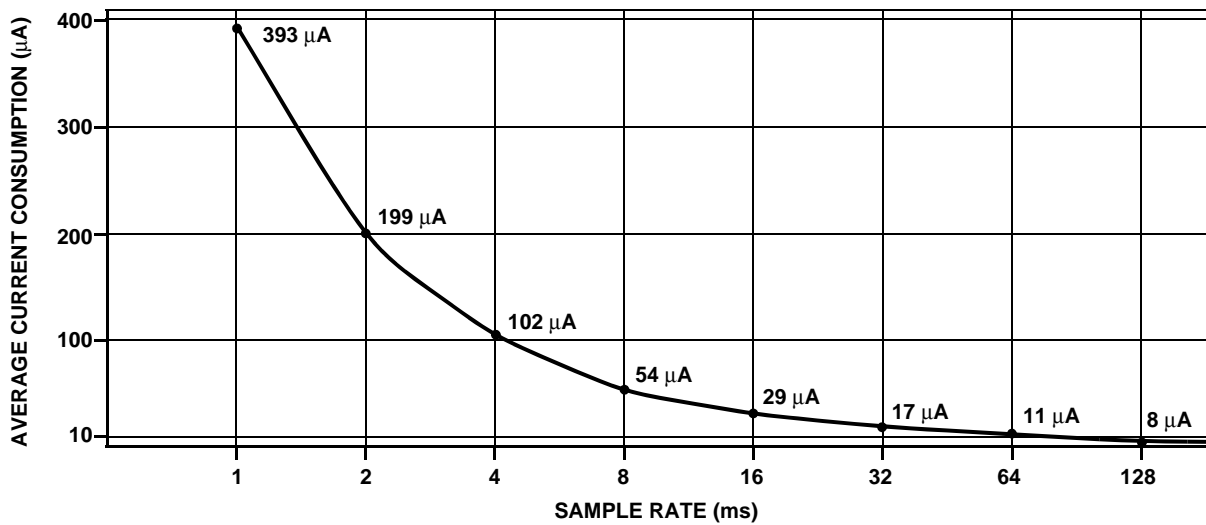

Figure 23. Average Supply Current

The output data is the Filtered Data High and Low is the data coming out of the second stage filter. This means that the response time of the output is the SFI times the ESI. This usually results in 16 ms and 4 iterations being used to get 64 ms response time while still optimizing the power consumption. At each 64 ms, a decision would be made regarding touch by comparing the Baseline with the filtered data output, resulting in a worst case of the full 64 ms plus half the previous cycle, equalling 96 ms.

AN3891: MPR121 Baseline System

INTRODUCTION

Touch acquisition takes a few different parts of the system in order to detect touch. The baseline filter and touch detection are tightly coupled. The purpose of the baseline filter is to “filter out touches” resulting in a system that is similar to a long term average but also takes into account that one specific signature. A touch must have different properties than noise and environmental change with respect to the filter response. This is accomplished through four register types that operate under different conditions. These are Max Half Delta (MHD), Noise Half Delta (NHD), Noise Count Limit (NCL) and Filter Delay Limit (FDL).

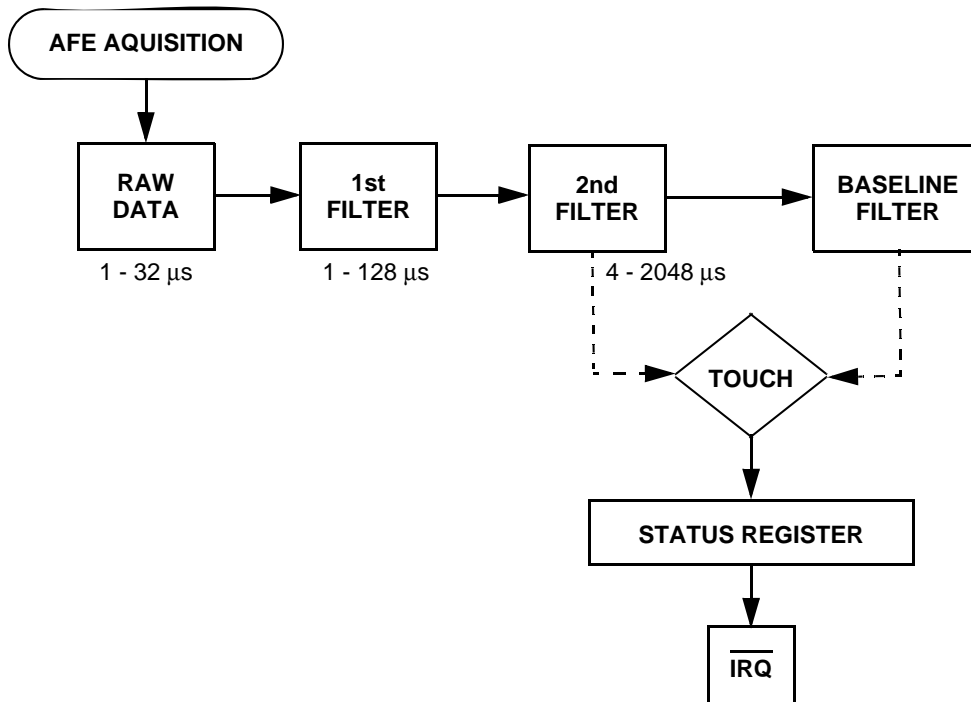

Figure 24. Data Flow in the MPR121

MAX HALF DELTA (NHD)

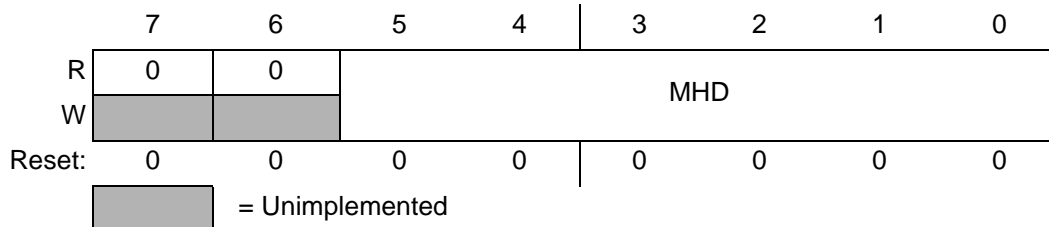

Table 22. Max Half Delta Register Field Descriptions

Field	Description
5:0 MHD	Max Half Delta – The Max Half Delta determines the largest magnitude of variation to pass through the third level filter. 000000 DO NOT USE THIS CODE 000001 Encoding 1 – Sets the Max Half Delta to 1 ~ 111111 Encoding 63 – Sets the Max Half Delta to 63

NOISE HALF DELTA (NHD)

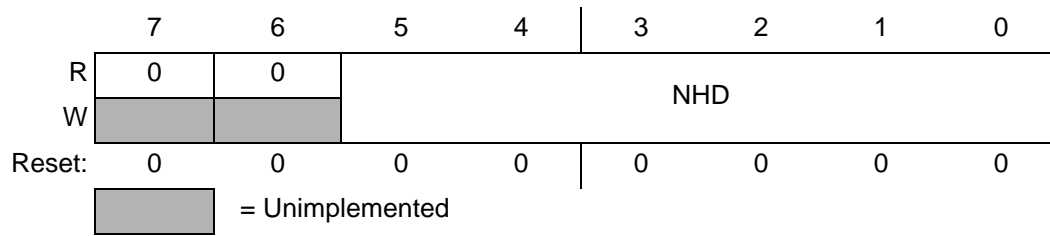

Figure 25. Noise Half Delta Register

Table 23. Noise Half Delta Register Field Descriptions

Field	Description
5:0 NHD	Noise Half Delta – The Noise Half Delta determines the incremental change when non-noise drift is detected. 000000 DO NOT USE THIS CODE 000001 Encoding 1 – Sets the Noise Half Delta to 1 ~ 111111 Encoding 63 – Sets the Noise Half Delta to 63

NOISE COUNT LIMIT (NCL)

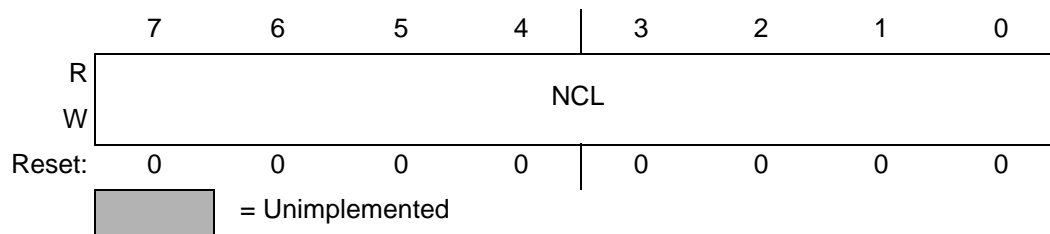

Figure 26. Noise Count Limit Register

Table 24. Noise Count Limit Register Field Descriptions

Field	Description
7:0 NCL	Noise Count Limit – The Noise Count Limit determines the number of samples consecutively greater than the Max Half Delta necessary before it can be determined that it is non-noise. 00000000 Encoding 0 – Sets the Noise Count Limit to 1 (every time over Max Half Delta) 00000001 Encoding 1 – Sets the Noise Count Limit to 2 consecutive samples over Max Half Delta ~ 11111111 Encoding 255 – Sets the Noise Count Limit to 255 consecutive samples over Max Half Delta

FILTER DELAY LIMIT (FDL)

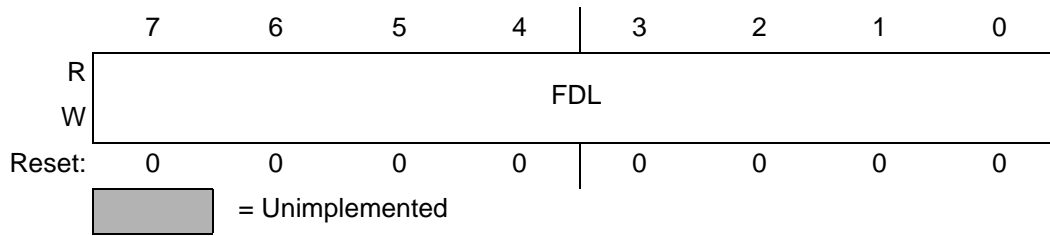

Figure 27. Filter Delay Limit Register

Table 25. Filter Delay Limit Register Field Descriptions

Field	Description
7:0 FDL	Filter Delay Limit – The Filter Delay Limit determines the rate of operation of the filter. A larger number makes it operate slower. 00000000 Encoding 0 – Sets the Filter Delay Limit to 1 00000001 Encoding 1 – Sets the Filter Delay Limit to 2 ~ 11111111 Encoding 255 – Sets the Filter Delay Limit to 255

Additionally there are different conditions in the system that affects how these registers operate. These are rising data, falling data or touched data. When the data changes between these conditions, the current filter process is cancelled and all filter counters return to zero.

The operation of the filter is in the relationship between the 2nd filter data and the baseline filter value. The occurrence of a touch will also change the operation of the system. The touch generation process is described in the application note AN3892. The falling data system is enabled any time the 2nd filter data is less than the baseline filter data. The rising data system is enabled any time the 2nd filter data is greater than the baseline filter data. The following cases describe the baseline system when it is not changing between the three states mentioned above.

Case 1

Small incremental changes to the system represent long term slow (environmental) changes in the system. The MHD setting regulates this case by allowing any data that is less than two times the MHD to pass the filter. Thus, if the baseline is 700 and the data is 701 with a MHD of one, then the baseline filter would increase to equal the data for the next cycle.

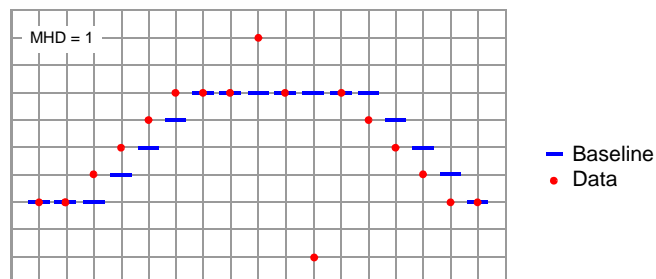

Figure 28. Max Half Delta

Case 2

Changes that are larger than double the MHD are regarded as noise and accounted for by the values of the NHD and NCL. Any data outside the MHD is rejected by the filter however sequential values that fall into this category are counted and if enough sequential data exists then the baseline will be adjusted.

In this case, the NCL regulates how many sequential data points must be seen before the data is changed. When the count is reached, the baseline is incremented by the NHD.

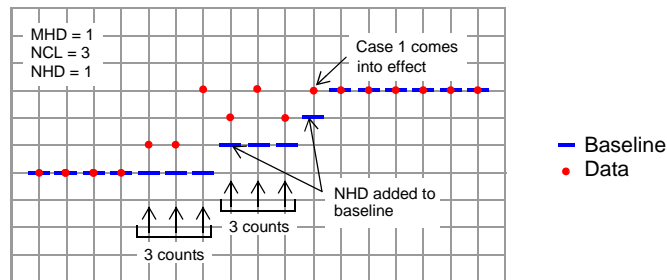

Figure 29.

Case 3

When the data is inconsistent but greater than double than MHD the baseline will not vary. Each time a transition takes place, the filter counters are reset, thus the fact that the data is oscillating around the baseline means that the noise is rejected and the baseline will not vary.

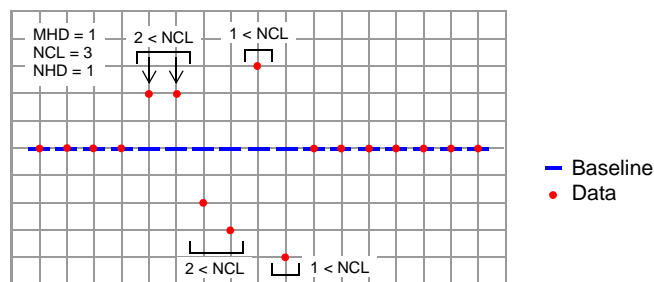

Figure 30.

Case 4

Low frequency changes to the data can trick the filter in some instances. The FDL is also available to slow down the overall system. This is done by taking an average of the specified number of values before running them through the baseline filter.

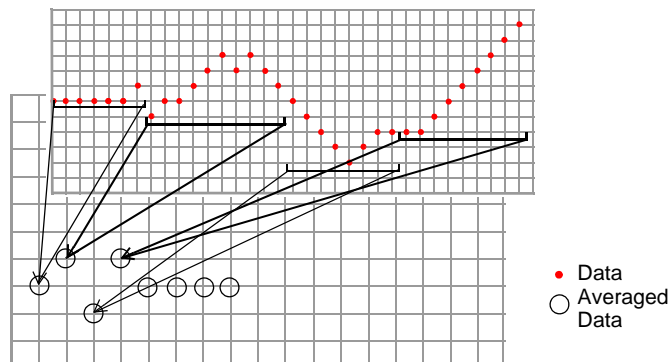

Figure 31.

After this averaging the filter reacts to Cases 1, 2, and 3.

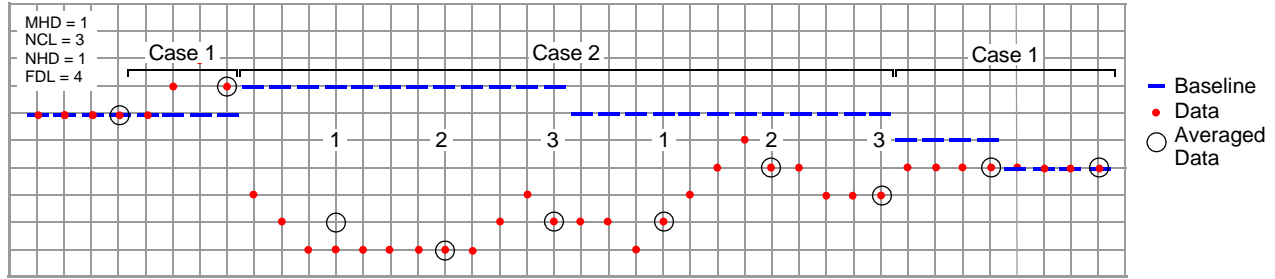

Figure 32.

ADVANCED CASES

With an understanding of the basic cases, more advanced cases can be discussed. In a touch sensor system, we can take advantage of some known properties to improve the functionality of the filter. These include direction of change, touch occurrence and the rate of touch. The first four cases are still utilized but more functionality is added. The following cases described how different settings are useful as opposed to what exactly the settings do, like cases 1-4.

Case 5

The direction of change for a touch in the system is always negative. Thus the system takes advantage of this by allowing for varying parameters for different directions of change. Since a touch can only be in the decreasing direction, it is usually best to set the decreasing filter to be slower than the increasing one. This allows for automatic recovery from a bad baseline reading.

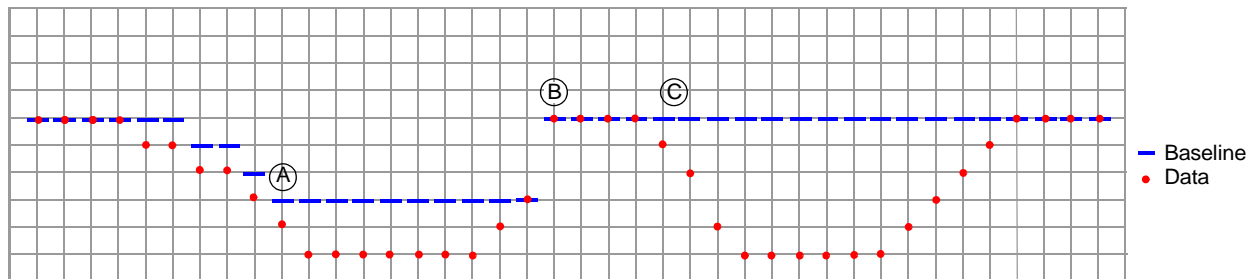

- As the touch occurs, the baseline is decreased slowly due to a non solid touch, but due to the slow reaction, a touch is still detected.
- The baseline quickly snaps back to the initial value by having fast filtering in the positive direction
- The repeated touch is easily handled since the baseline quickly adjusted; if it was slow, the second touch would have resulted in a possible false negative for a touch detection.

Figure 33.

Case 6

The system needs the capability to handle environment changes that appear very similar to actual touches. In Case 5, the touch was a real touch, but slow enough that initially it is thought better for the baseline not to change at all.

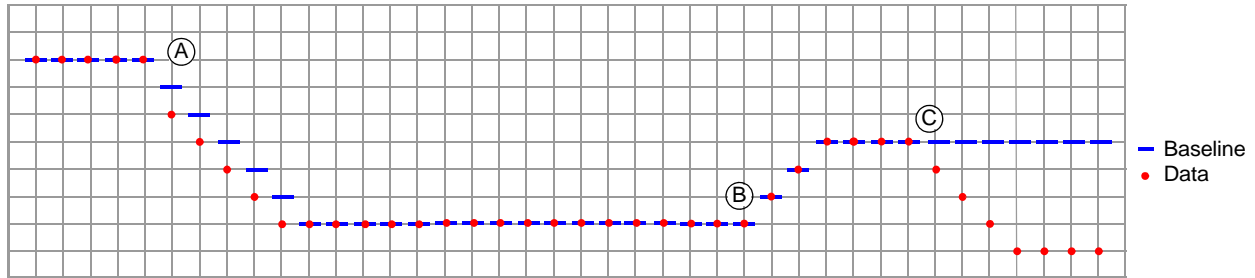

- A. The decrease is the interface being cleared with a wet rag, causing a relatively slow capacitance change. The baseline accurately tracks this slow change.
- B. The baseline begins to increase as the interface becomes dry.
- C. A delta from the new baseline allows a touch to be accurately detected.

Figure 34.

Case 7

This case is when a touch is occurring. While the baseline system does not detect a touch, it is obviously an important part of the process. The baseline can be set to slowly calibrate a touch from the system preventing keys from becoming stuck. Only the NHD, NCL and FDL are necessary since the value can never be less than double the MHD.

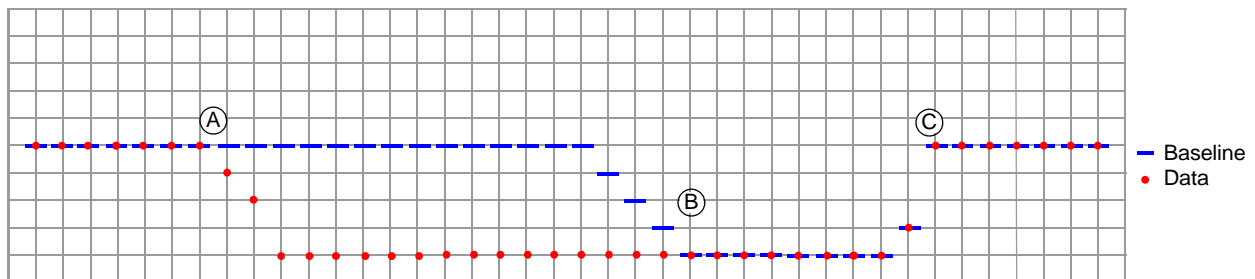

- A. The touch is detected which disengages the increasing/decreasing baseline filter but leaves it enabled with very slow filtering
- B. Even though the touch has not been released it times out and is eventually rejected.
- C. Normal baseline filter is engaged.

Figure 35.

Case 8

This case can also prevent keys from being stuck due to misuse. For example, if a metal pen touches a button, this may initially engage the button but the pen is calibrated out over time and, normal function resumes. The same applies to water, food humid environments and other instances that generate capacitance change.

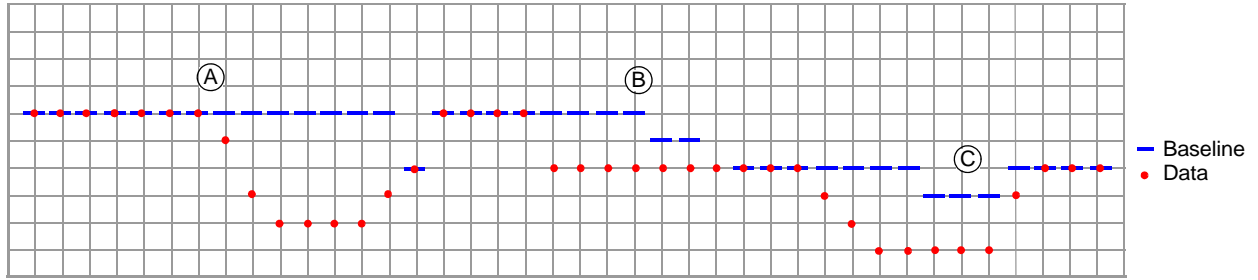

- A. Valid normal touch
- B. False touch filtered out
- C. Touch from new adjusted baseline

Figure 36.

AN3892: MPR121 Jitter and False Touch Detection

INTRODUCTION

Touch acquisition takes a few different parts of the system in order to detect touch. The baseline filter and touch detection are tightly coupled. The purpose of the touch detection block is to use the baseline value and the 2nd level filter data to determine when a user has touched an electrode. The electrodes are independently configured using the Touch Threshold and Release Threshold registers. The global Debounce register also controls when a touch is detected by adding some minimal delay. The data is then output through a couple of registers: Filtered Data High, Filtered Data Low, Baseline Data and two touch output registers.

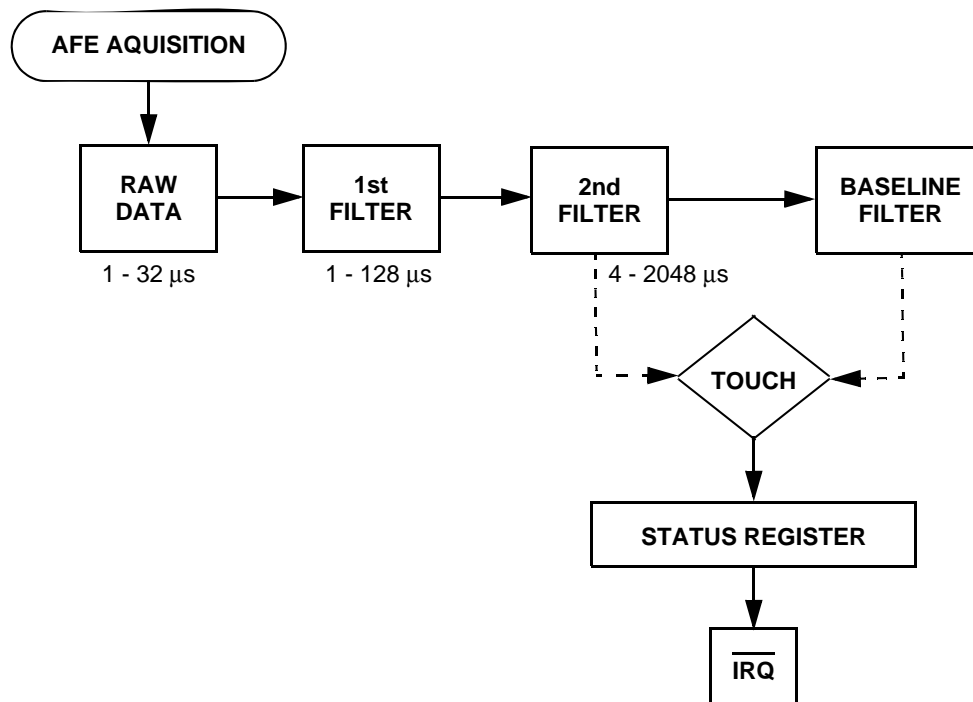

Figure 37. Data Flow in the MPR121

First, the MPR121 touch sensor detects touch by the methods in this application note, and the data is output through the first two registers in the map. The two touch status registers both trigger an interrupt on any change of the data. Thus, as a touch happens (bit is set) an interrupt will be triggered, and when a touch is released (bit is cleared) it will also trigger. To clear the interrupt all you must do is initiate a I2C communication, with the intent that you read register 0x00 and 0x01 to determine which electrodes are touched.

TOUCH STATUS REGISTER 0

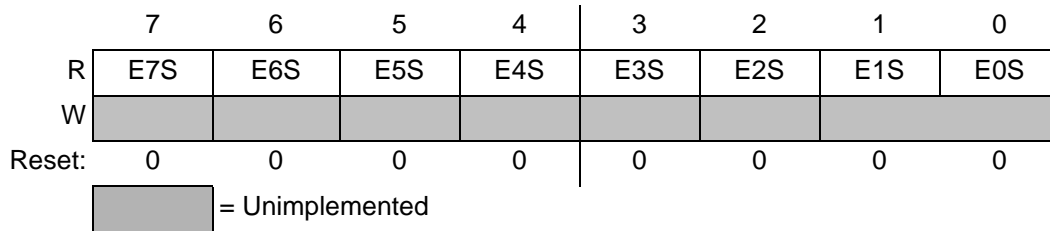

Figure 38. Touch Status Register 0

Table 26. Touch Status Register 0 Field Descriptions

Field	Description
7 E7S	Electrode 7 Status – The Electrode 7 Status bit shows touched or not touched. 0 – Not Touched 1 – Touched
6 E6S	Electrode 6 Status – The Electrode 6 Status bit shows touched or not touched. 0 – Not Touched 1 – Touched
5 E5S	Electrode 5 Status – The Electrode 5 Status bit shows touched or not touched. 0 – Not Touched 1 – Touched
4 E4S	Electrode 4 Status – The Electrode 4 Status bit shows touched or not touched. 0 – Not Touched 1 – Touched
3 E3S	Electrode 3 Status – The Electrode 3 Status bit shows touched or not touched. 0 – Not Touched 1 – Touched
2 E2S	Electrode 2 Status – The Electrode 2 Status bit shows touched or not touched. 0 – Not Touched 1 – Touched
1 E1S	Electrode 1 Status – The Electrode 1 Status bit shows touched or not touched. 0 – Not Touched 1 – Touched
0 E0S	Electrode 0 Status – The Electrode 0 Status bit shows touched or not touched. 0 – Not Touched 1 – Touched

TOUCH STATUS REGISTER 1

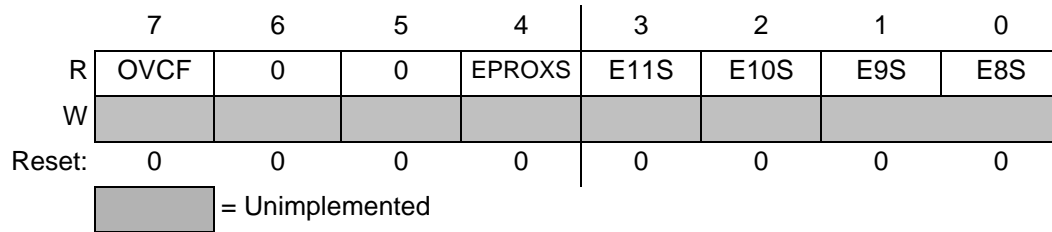

Figure 39. Touch Status Register1

Table 27. Touch Status Register 1 Field Descriptions

Field	Description
7 OVCF	Over Current Flag – The Over Current Flag will be set any time the wrong value of Rext is connected to the MPR121's Rext pin. This is to protect the part from high current that could result from an incorrect resistor value. 0 – Correct Rext resistor value 1 – Incorrect Rext resistor value
4 EPROXS	Electrode PROX Status – The Electrode PROX Status bit shows touched nor not touched. 0 – Not Touched 1 – Touched
3 E11S	Electrode 11 Status – The Electrode 11 Status bit shows touched or not touched. 0 – Not Touched 1 – Touched
2 E10S	Electrode 10 Status – The Electrode 10 Status bit shows touched or not touched. 0 – Not Touched 1 – Touched
1 E9S	Electrode 9 Status – The Electrode 9 Status bit shows touched or not touched. 0 – Not Touched 1 – Touched
0 E8S	Electrode 8 Status – The Electrode 8 Status bit shows touched or not touched. 0 – Not Touched 1 – Touched

FILTER DATA HIGH

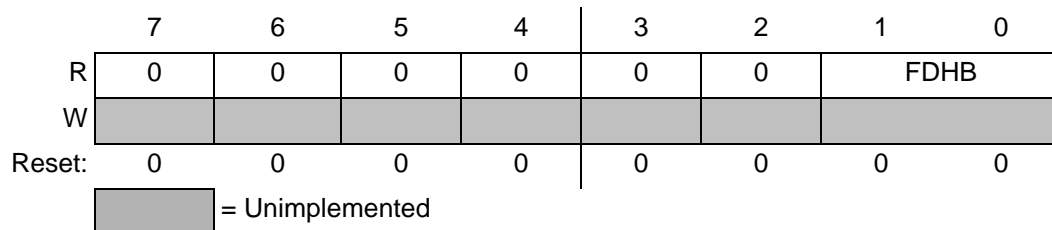

Figure 40. Filtered Data High Register

Table 28. Filtered Data High Register Field Descriptions

Field	Description
7:0 FDHB	Filtered Data High Bits – The Filtered Data High Bits displays the higher 2 bits of the 10 bit filtered A/D reading. 00 Encoding 0 ~ 11 Encoding 3

FILTERED DATA LOW

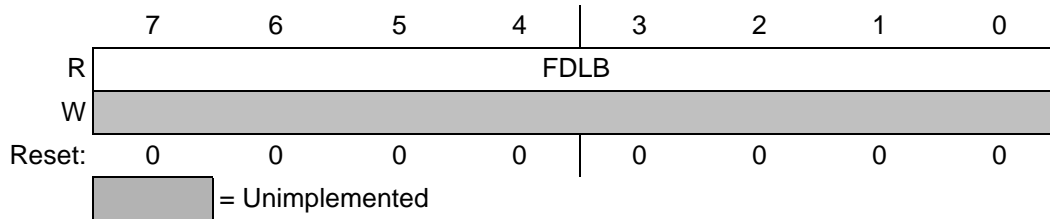

Figure 41. Filtered Data Low Register

Table 29. Filtered Data Low Register Field Descriptions

Field	Description
7:0 FDLB	Filtered Data Low Byte – The Filtered Data Low Byte displays the lower 8 bits of the 10 bit filtered A/D reading. 00000000 Encoding 0 ~ 11111111 Encoding 255

BASELINE VALUE

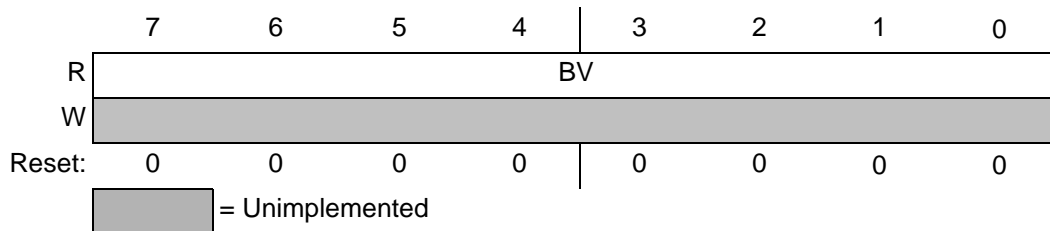

Figure 42. Filtered Data High Register

Table 30. Filtered Data High Register Field Descriptions

Field	Description
7:0 BV	Baseline Value – The Baseline Value byte displays the higher 8 bits of the 10 bit baseline value. 00000000 Encoding 0 – The 10 bit baseline value is between 0 and 3. ~ 11111111 Encoding 255 – The 10 bit baseline value is between 1020 and 1023.

In this system, a touch is defined as any time the difference between the Filtered Data and the Baseline Value is greater than the threshold. Since this calculation is done totally internal to the part, it is unnecessary for the user to actually do this math in the software. If it were being done, the steps would be to first combine the Filtered Data Low and Filtered Data High values into a single 10-bit number. Thus,

$$Data = Filtered\ Data\ High \cdot 256 + Filtered\ Data\ Low$$

The baseline is then shifted to the left to make it equal scale to the Data.

$$Baseline = Baseline\ Value \cdot 4$$

Internally to the device, the full 10-bit value is stored, but as this level of precision is not necessary as the low two bits are disregarded for output. The Touch Threshold is a user defined value. There is both a touch and an un-touch threshold to provide hysteresis.

TOUCH THRESHOLD REGISTER

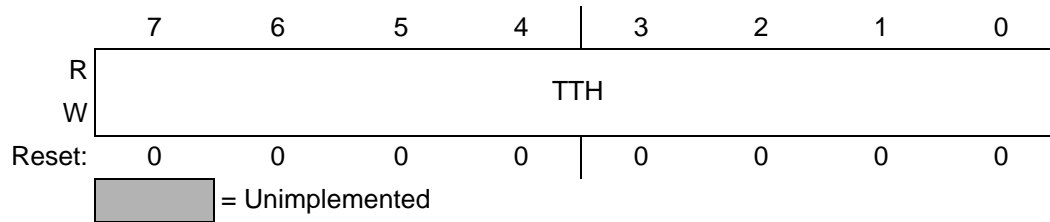

Figure 43. Touch Threshold Register

Table 31. Touch Threshold Register Field Descriptions

Field	Description
7:0 TTH	Touch Threshold – The Touch Threshold Byte sets the trip point for detecting a touch. 00000000 Encoding 0 ~ 11111111 Encoding 255

RELEASE THRESHOLD REGISTER

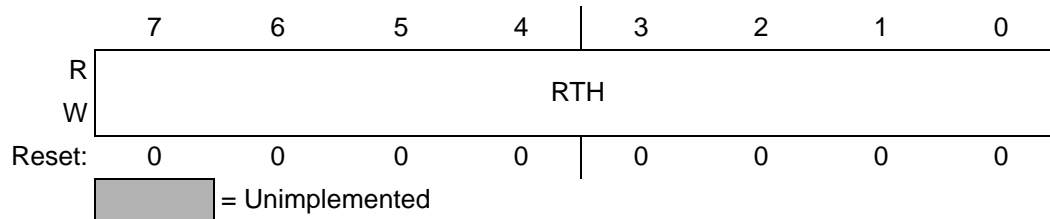

Figure 44. Release Threshold Register

Table 32. Release Threshold Register Field Descriptions

Field	Description
7:0 RTH	Release Threshold – The Release Threshold Byte sets the trip point for detecting a touch. 00000000 Encoding 0 ~ 11111111 Encoding 255

For the system to recognize a touch the delta must be greater than the Touch Threshold.

$$\Delta = \text{Baseline} - \text{Data}$$

$$\text{Trigger Touch} \rightarrow \Delta > \text{Touch Threshold}$$

A release is triggered when the Delta falls below the Release Threshold. This can happen for both changes to the Baseline and actual Data changes. To understand how the Baseline can change, refer to AN3891.

$$\text{Trigger Release} \rightarrow \Delta < \text{Touch Threshold}$$

DEBOUNCE TOUCH AND RELEASE REGISTER

The last register available in this set is the Debounce register. The Debounce register maintains the accuracy of touch and releases by further improving the performance. The debounce allows two different settings to prevent bounce in the end system. If the value is set to 0x22, the requirement would be three sequential changes in status before the change would be recognized.

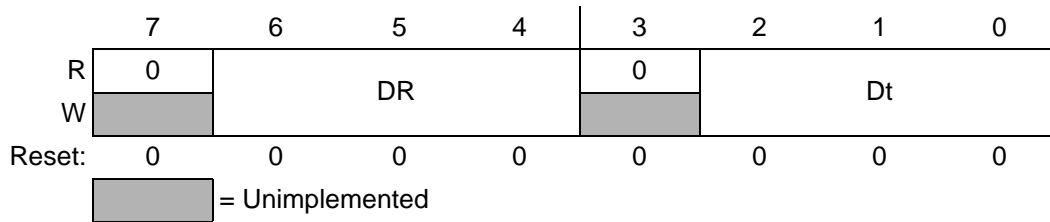

Figure 45. Debounce Touch and Release Register

Table 33. Debounce Touch and Release Register Field Descriptions

Field	Description
6:4 DR	Debounce Release – The Debounce Release determines the number of sequential release detections before an interrupt is triggered and a release is reported. 000 Encoding 0 - Consecutive releases detection before Status change is 1 001 Encoding 1 - Consecutive releases detection before Status change is 2 ~ 007 Encoding 7 - Consecutive releases detection before Status change is 8
2:0 DT	Debounce Touch – The Debounce Touch determines the number of sequential touch detections before an interrupt is triggered and a touch is reported. 000 Encoding 0 - Consecutive touch detection before Status change is 1 001 Encoding 1 - Consecutive touch detection before Status change is 2 ~ 007 Encoding 7 - Consecutive touch detection before Status change is 8

CONCLUSION

The use of each of the features together can have a great effect of the jitter and false couch rejection. Jitter is prevented by utilizing the two threshold settings. Thus the provided hysteresis prevent Jitter on the data from going through the to the output Depending on environmental conditions, the Debounce can be used to eliminate the remainder of dramatic change of the signal that aren't really touches.

Additional filtering can be done before the data gets to the touch detection system. Refer to Freescale Application Note AN3890.

AN3893: MPR121 Proximity Detection

INTRODUCTION

MPR121 is a feature rich, second generation touch sensor controller after Freescale's initial release of the MPR03x series device. Like MPR03x, MPR121 has a unique feature that all the electrode inputs can be internally connected together so that all the surface touch sensing area on the inputs are "summed" together to act as a single large electrode pad. This can effectively increase the total area of the sensing conductor for non-contact near proximity detection for hand approaching.

OVERVIEW

Capacitive proximity detection uses the same principle as capacitive touch sensing. Each MPR121 input sensing channel can be used as contactless proximity detection as well as finger touch detection if each sensing pad is designed properly and relevant register are set properly.

Typically a smaller pad size is used for finger touch button detection; while a larger pad size is necessary for contactless near proximity detection. On the other side, it's true that in most portable application design there is no dedicated big surface area left for proximity detection as the touch sensing buttons occupy all the available surface area. To make proximity detection at the same time of touch detection without additional dedicated large sensing pad, MPR121 has an internal input multiplexor which can connect all input sensing channels together so that all the touch sensing surface areas on the input pads are "summed" together effectively acting as a single large sensing pad.

Using this scheme in typical applications, the 12 channels can be used for 12 key buttons touch sensing, and the surface area of all the pads can also used for proximity detection (e.g., hand approaching).

PROXIMITY DETECTION REGISTER SETTING

Like each independent touch sensing detection, the 13th Proximity Detection electrode also has its own register configurations, other than that, all the concepts applied to the proximity detection are the same as touch sensing detection.

1.0 Enable Proximity Sensing

Proximity detection (a/k/a area detection mode) is enabled by configuring the Electrode Configuration Register (0x5E), see [Table 34](#). In MPR121, this adds an area detection step (the 13th pseudo Electrode) before all the independent electrodes touch sensing detect sequence. Once configured, we refer to this area detection as the 13th Proximity Detection electrode.

Table 34. Electrode Configuration Register 0x5E (Reset Default: 0x00)

Bit	Bit7	Bit6	Bit5	Bit4	Bit3	Bit2	Bit1	Bit0
Read	CL[1]	CL[0]	AD[1]	AD[0]	EC[3]	EC[2]	EC[1]	EC[0]
Write								
Reset	0	0	0	0	0	0	0	0

AD1	AD0	EC3	EC2	EC1	EC0	Description
0	1	x	x	x	x	Area Detection by connecting ELE0~1.
1	0	x	x	x	x	Area Detection by connecting ELE0~3.
1	1	x	x	x	x	Area Detection by connecting ELE0~11.

2.0 Proximity Data Register and Baseline Register

Eleprox Electrode Registers (0x1C, 0x2D) contain the 10-bit raw data of the capacitance-voltage measurement value for the 13th Proximity Detection electrode.

Table 35. Eleprox Electrode Register 0x1C, 0x2D (Reset Default: 0x00, 0x00)

0x1C	Bit7	Bit6	Bit5	Bit4	Bit3	Bit2	Bit1	Bit0
	D7	D6	D5	D4	D3	D2	D1	D0

0x1D	Bit7	Bit6	Bit5	Bit4	Bit3	Bit2	Bit1	Bit0
	—	—	—	—	—	—	D9	D8

Eleprox Baseline Value Register (0x2A) contains the 8 MSBs of the 10-bit baseline value for the 13th Proximity Detection electrode. Writing to Baseline Value Register updates the 8 MSBs of baseline value and clears the 2 LSBs to zero. The Baseline Value Registers can only be written when in Shutdown Mode, but the current values may be read at any time.

Table 36. Eleprox Baseline Value Register 0x2A (Reset Default: 0x00)

0x2A	Bit7	Bit6	Bit5	Bit4	Bit3	Bit2	Bit1	Bit0
	D9	D8	D7	D6	D5	D4	D3	D2

3.0 Proximity Sensing Status Indication

MPR121 provides a single proximity sensing status bit (ELE[12] in table below) in the Touch Status Register. This status bit changes as a result of internal detection algorithm using the proximity raw data with the proximity baseline value and proximity touch/release threshold setting. When ELE[12] is set, the proximity is deemed as detected, and undetected when ELE[12] is 0.

Table 37. Status Register 0x00, 0x01 (Reset Default: 0x00)

0x00	Bit7	Bit6	Bit5	Bit4	Bit3	Bit2	Bit1	Bit0
	ELE[7]	ELE[6]	ELE[5]	ELE[4]	ELE[3]	ELE[2]	ELE[1]	ELE[0]

0x01	Bit7	Bit6	Bit5	Bit4	Bit3	Bit2	Bit1	Bit0
	OVCF	0	0	ELE[12]	ELE[11]	ELE[10]	ELE[9]	ELE[8]

The update rate of this status bit will be determined by sampling rate and detection debounce setting. The status bit will not immediately change if the Debounce Register is non zero. This Debounce Register is globally effective to prevent possible flick noise for both touch and proximity sensing. The value in the Debounce Register determines how many numbers of sample intervals are needed to pass at the touch/release threshold before the status bit is finally changed.

Table 38. Debounce Register 0x5B (Reset Default: 0x00)

0x5B	Bit7	Bit6	Bit5	Bit4	Bit3	Bit2	Bit1	Bit0
	X	DR[2]	DR[1]	DR[0]	X	DT[2]	DT[1]	DT[0]

On ELEPROX status bit change, the interrupt pin will be asserted.

4.0 Proximity Detection Touch/Release Threshold

Similar to the touch/release threshold for touch detection, the proximity detection also has a pair of touch/release threshold setting registers. The programmable threshold setting range is 0~63 count, representing the delta change below the baseline value when touched or released. The Threshold should be set according to the system SNR requirement and also provide adequate headroom for mass production variation. For normal application, set Touch Threshold slightly larger than Release Threshold so that there is no flick detection.

Example: Touch Threshold = 0x08, Release Threshold = 0x05.

Table 39. Eleprox Touch Threshold Register 0x59 (Reset Default: 0x00)

0x59	Bit7	Bit6	Bit5	Bit4	Bit3	Bit2	Bit1	Bit0
	D7	D6	D5	D4	D3	D2	D1	D0

Table 40. Eleprox Release Threshold Register 0x5A (Reset Default: 0x00)

0x5A	Bit7	Bit6	Bit5	Bit4	Bit3	Bit2	Bit1	Bit0
	D7	D6	D5	D4	D3	D2	D1	D0

5.0 Proximity Baseline Filter Setting

As with the touch detection, the proximity detection also dedicates register sets for baseline filter control. These include the maximum half delta for rising/falling, the noise half delta for rising/falling/touched, the noise count limit for rising/falling/touched, and filter delay for rising/falling/touched. Table 41 shows an example setting for proximity sensing, the concept is to have quickest response on baseline rising (when hand takes away) and slowest response on baseline falling (when hand approaching). Refer to Freescale application note AN3891 for detailed description on baseline system.

Table 41. Proximity Baseline Filter Registers 0x36~0x40 (Reset Default: all 0x00)

Register Name	Register Address	Example Setting
ELEPROX Max Half Delta Rising	0x36	0xFF
ELEPROX Noise Half Delta Amount Rising	0x37	0xFF
ELEPROX Noise Count Limit Rising	0x38	0x00
ELEPROX Filter Delay Limit Rising	0x39	0x00
ELEPROX Max Half Delta Falling	0x3A	0x01
ELEPROX Noise Half Delta Amount Falling	0x3B	0x01
ELEPROX Noise Count Limit Falling	0x3C	0xFF
ELEPROX Filter Delay Limit Falling	0x3D	0xFF
ELEPROX Noise Half Delta Amount Touched	0x3E	0x00
ELEPROX Noise Count Limit Touched	0x3F	0x00
ELEPROX Filter Delay Limit Touched	0x40	0x00

6.0 Electrode Configuration for Proximity Sensing

Same as touch sensing, the proximity sensing requires that the charging current and time for the 13th Proximity Detection electrode to be properly set. This can be done in 3 ways:

1. Globally setting the AFE Configuration Register (0x5B) and Filter Configuration Register if recent current setting and time setting is zero.
2. Set by using Eleprox Electrode Current Register (0x6B) and Charge Time Register (0x72).
3. Using Auto-Configuration function to automatically set charge current and charge time for this 13th Proximity Detection electrode.

It's recommended that Auto-Configuration is used for design efficiency if proximity sensing works properly in this way. Refer to Freescale application note AN3889 for details of the Auto-Configuration function.

7.0 AFE and Filter Configuration Register

The last two registers relevant to proximity detection are the AFE Configuration Register and Filter Configuration Register. These two registers set the numbers of samples for the 2 level filters and the sampling interval for the second level filter.

Table 42. Filter Configuration Registers 0x5D (Reset Default: 0x24)

0x5D	Bit7	Bit6	Bit5	Bit4	Bit3	Bit2	Bit1	Bit0
	CDT[2:0]			SFI[1:0]		ESI[2:0]		

Table 43. AFE Configuration Registers 0x5C (Reset Default: 0x10)

0x5C	Bit7	Bit6	Bit5	Bit4	Bit3	Bit2	Bit1	Bit0
	FFI[1:0]		CDC[4:0]					

The FFI[1:0], SFI[1:0] and ESI[2:0] bits in the registers are those related to the first filter, second filter and sample interval respectively. These two registers are powered up with default setting of 0x24 and 0x10 respectively. The default setting is already workable for proximity sensing, but since ESI[2:0] is 100, the sampling interval is at 16 ms. If lower power consumption is desired, the user can adjust it to the value to find a balance between the proximity detection response time current consumption. For a detailed explanation on these registers, please refer to Freescale application note AN3890.

OTHER DESIGN CONSIDERATIONS

1. Remember the paralleled plate capacitor model when considering the proximity detection. Larger sensing area (the effective sensing area formed by the sensing pad and material under detection, e.g. the surface area of hand projected to the sensing pad) gives longer proximity sensing distance.
2. The electric energy store in the capacitance (thus the strength of the sensing field) is proportional to the square of the voltage potential applied. Setting the auto-configure target level as high as possible will help extend the proximity sensing range.
3. Since increasing the sensing pad area also has the problem of making it easier to receive the electric noise. It's possible that the original solid sensing pad can be replaced by a series of circles or x hatch patterns.

Refer to Freescale application note AN3863 for more detailed discussion on electrode and layout design considerations.

AN3894: MPR121 GPIO and LED Driver Function

INTRODUCTION

MPR121 is a feature rich second generation touch sensor controller after Freescale's initial release of the MPR03x series device. MPR121 not only has priority unique features like independent electrode auto configuration (refer to AN3889), 13th simulated pseudo electrode for proximity detection (refer to AN3893), it also has 8 GPIO ports with LED driver capability. The GPIO and LED driver function can be used when not all the 12 input sensing channels are occupied for touch sensing detection, which is made possible by internal multiplexed pin structure. This increases the cost efficiency of the system and makes the MPR121 fit for even wider application.

MULTIFUNCTION PINS

MPR121 has 12 input sensing channels ELE0~ELE11, which occupies pin 8 to pin 19. Among these, pin 12 to pin 19 are multifunction pins. When these multifunction pins are not configured as electrodes, they may be used to drive LED or for general GPIO purpose.

PIN #	8	9	10	11	12	13	14	15	16	17	18	19
ELECTRODE	ELE0	ELE1	ELE2	ELE3	ELE4	ELE5	ELE6	ELE7	ELE8	ELE9	ELE10	ELE11
GPIO	—	—	—	—	GPIO0	GPIO1	GPIO2	GPIO3	GPIO4	GPIO5	GPIO6	GPIO7

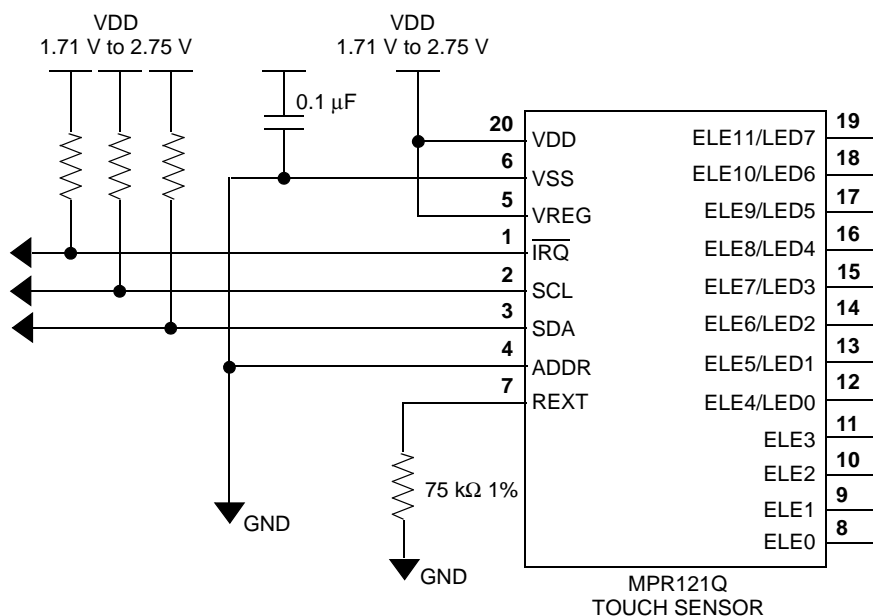

Figure 46. Configuration 1: MPR121 runs from a 1.71 V to 2.75 V supply.

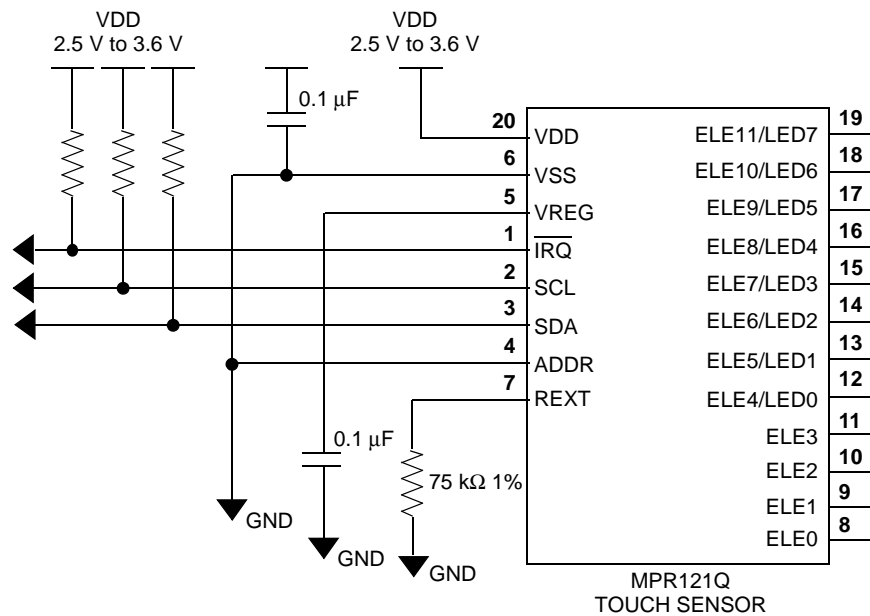

Figure 47. Configuration 2: MPR121 runs from a 2.5 V to 3.6 V supply.

These registers control GPIO function. D7~D0 bits corresponds GPIO7~GPIO0 pins respectively. The GPIO control registers can write always regardless Shutdown and Run mode.

Table 44. GPIO Control Registers

Name	Address	D7	D6	D5	D4	D3	D2	D1	D0
GPIO Control 0	0x73	CTL0[7]	CTL0[6]	CTL0[5]	CTL0[4]	CTL0[3]	CTL0[2]	CTL0[1]	CTL0[0]
GPIO Control 1	0x74	CTL1[7]	CTL1[6]	CTL1[5]	CTL1[4]	CTL1[3]	CTL1[2]	CTL1[1]	CTL1[0]
GPIO Data	0x75	DAT[7]	DAT[6]	DAT[5]	DAT[4]	DAT[3]	DAT[2]	DAT[1]	DAT[0]
GPIO Direction	0x76	DIR[7]	DIR[6]	DIR[5]	DIR[4]	DIR[3]	DIR[2]	DIR[1]	DIR[0]
GPIO Enable	0x77	EN[7]	EN[6]	EN[5]	EN[4]	EN[3]	EN[2]	EN[1]	EN[0]
GPIO Data Set	0x78	SET[7]	SET[6]	SET[5]	SET[4]	SET[3]	SET[2]	SET[1]	SET[0]
GPIO Data Clear	0x79	CLR[7]	CLR[6]	CLR[5]	CLR[4]	CLR[3]	CLR[2]	CLR[1]	CLR[0]
GPIO Data Toggle	0x7A	TOG[7]	TOG[6]	TOG[5]	TOG[4]	TOG[3]	TOG[2]	TOG[1]	TOG[0]

EN[7:0], DIR[7:0], CTL0[7:0], CTL1[7:0]: Configuration Register

The number of touch sensing electrodes (and therefore the number of GPIO ports available) is configured by the Electrode Configuration register (0x5E) and GPIO Enable Register (0x77), but electrode configuration has higher priority than GPIO feature. When a pin is enabled as GPIO but is also selected as electrode by Electrode Configuration Register, the GPIO function is disabled immediately and it becomes an electrode during Run mode. But all 8 ports automatically become GPIO ports in Shutdown mode because none of the ports are being enabled as touch electrodes in Shutdown mode.

During the shutdown mode just after power on reset, all 8 GPIO ports are in high impedance as all the GPIO ports are default disabled. Take care to program unused ports which are not going to be used as either touch electrodes or GPIO to avoid floating inputs or outputs shorted to a rail. One approach is to enable unused ports to be GPIO inputs with internal pull-up or pull-down.

The GPIO system allows the GPIO pins to be set as input or output. When an EN bit sets, the corresponding GPIO pin is enabled and the function is configured by CTL0, CTL1 and DIR bits. When the port is used as input, it can be configured as normal input or with additional internal pull-down or pull-up for input port. For output configuration, it can be push/pull or open drain.

EN	DIR	CTL[0:1]	DESCRIPTION
0	X	XX	GPIO function is disabled. Port is high-z state.
1	0	00	GPIO port becomes input port.
1	0	10	GPIO port becomes input port with internal pull-down.
1	0	11	GPIO port becomes input port with internal pull-up.
1	0	01	Not defined yet (as same as CTL = 00).
1	1	00	GPIO port becomes CMOS output port.
1	1	11	GPIO port becomes high side only open drain output port for LED driver.
1	1	10	GPIO port becomes low side only open drain output port.
1	1	01	Not defined yet (as same as CTL = 00).

DAT[7:0]: Data Register

When a GPIO is as output, the GPIO port outputs the bit level of this register. The output level toggle holds on any electrode charging and AD conversion and the level transition will be occurred after the AD conversion. Reading this register returns the content of the DAT register (not a level of the port).

When a GPIO is as input, reading this register returns latched input level of the corresponding port (not contents of the DAT register). A write changes content of the register, but not affect to the input function.

SET[7:0]: Set Data Register

Writing a "1" to bits in this register will set them in the Data Register.

CLR[7:0]: Clear Data Register

Writing a "1" to bits in this register will clear them in the Data Register.

TOG[7:0]: Toggle Data Register

Write a bit with "1" to the GPIO Data Set Register, GPIO Data Clear Register, and GPIO Toggle Register set/clear/toggle contents of the corresponding DAT bit. Write "0" has no meaning. Using of those registers allows any individual port(s) to be able individually set, cleared, or toggled without affecting other ports. Reading those register returns as same as DAT register reading.

LED DRIVER

Each GPIO pin has LED driver capability which can source up to 12 mA. When GPIO is used to driver LED, connect the GPIO output to an LED forward biased with its cathode to GND so that GPIO output high lights the LED. Place a current limiting resistor in series with LED to limit the current below 12 mA (refer to the typical application circuit).

When LED dimming control is needed, the PWM control register can be set to get the desired dimming control. Alternatively, the PWM can also be used to drive the beeper.

Table 45. PWM_[3:0]: PWM Duty Control Registers

Name	Address	D7	D6	D5	D4	D3	D2	D1	D0
PWM 0	0x81	PWM1[3]	PWM1[2]	PWM1[1]	PWM1[0]	PWM0[3]	PWM0[2]	PWM0[1]	PWM0[0]
PWM 1	0x82	PWM3[3]	PWM3[2]	PWM3[1]	PWM3[0]	PWM2[3]	PWM2[2]	PWM2[1]	PWM2[0]
PWM 2	0x83	PWM5[3]	PWM5[2]	PWM5[1]	PWM5[0]	PWM4[3]	PWM4[2]	PWM4[1]	PWM4[0]
PWM 3	0x84	PWM7[3]	PWM7[2]	PWM7[1]	PWM7[0]	PWM6[3]	PWM6[2]	PWM6[1]	PWM6[0]

PWM0[3:0] ~ PWM7[3:0] is used to set the PWM duty of GPIO0 ~ GPIO7 respectively. The power up reset default setting for these four register is 0x00. When a GPIO is programmed as output and the DAT register is "1" and if the corresponding PWM_[3:0] register is not zero, the GPIO pin outputs PWM waveform. The PWM period is fixed 8ms (1/256 of 32 KHz OSC) and PWM_[3:0] register decides duty of the waveform.

PWM_ [3:0]	Description (_ is 0-7)
0	PWM is off, GPIO outputs stable high when DAT register is "1"
1	GPIO output duty is 1:15 (mostly output low)
2	GPIO output duty is 2:14 (mostly output low)
—	—
15	GPIO output duty is 15:1 (mostly output high)

These register can be read/write any time, even if MPR121 is in Run Mode. When the register changes during PWM enables, a mixed duty cycle would be possible to occur.

The PWM duty is not so much accurate, because GPIO output transition (include PWM) inhibits during measurement state. Therefore, when interval time (=Touch Detection Sample Interval) is close to measurement time (depends on charge time, AFE Samples and number of measurement electrodes), the PWM operation is disturbed and the waveform couldn't keep programmed duty.

AN3895: MPR121 Serial Communication

INTRODUCTION

The MPR121 uses an I²C Serial Interface. The I²C protocol implementation and the specifics of communicating with the Touch Sensor Controller are detailed in this application note.

SERIAL-ADDRESSING

The MPR121 operates as a slave that sends and receives data through an I²C 2-wire interface. The interface uses a Serial Data Line (SDA) and a Serial Clock Line (SCL) to achieve bi-directional communication between master(s) and slave(s). A master (typically a microcontroller) initiates all data transfers to and from the MPR121, and it generates the SCL clock that synchronizes the data transfer.

The MPR121 SDA line operates as both an input and an open-drain output. A pull-up resistor, typically 4.7 k Ω , is required on SDA. The MPR121 SCL line operates only as an input. A pull-up resistor, typically 4.7 k Ω , is required on SCL if there are multiple masters on the 2-wire interface, or if the master in a single-master system has an open-drain SCL output.

Each transmission consists of a START condition (Figure 48) sent by a master, followed by the MPR121's 7-bit slave address plus R/W bit, a register address byte, one or more data bytes, and finally a STOP condition.

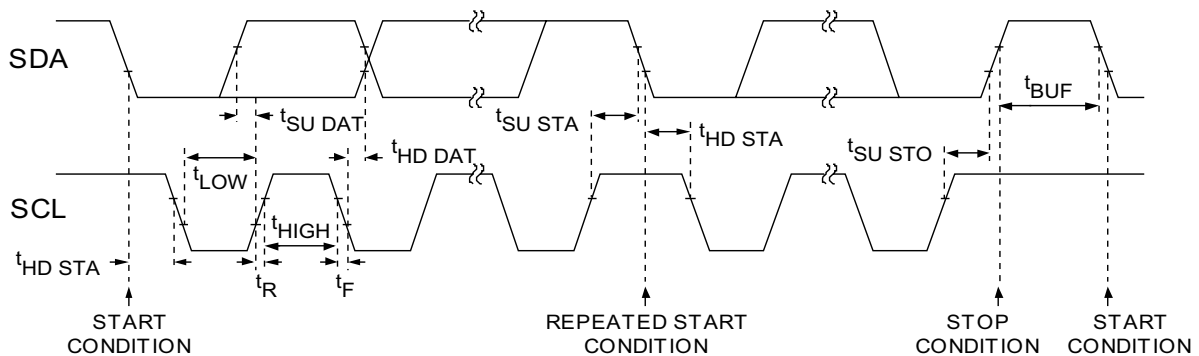

Figure 48. Wire Serial Interface Timing Details

START AND STOP CONDITIONS

Both SCL and SDA remain high when the interface is not busy. A master signals the beginning of a transmission with a START (S) condition by transitioning SDA from high to low while SCL is high. When the master has finished communicating with the slave, it issues a STOP (P) condition by transitioning SDA from low to high while SCL is high. The bus is then free for another transmission.

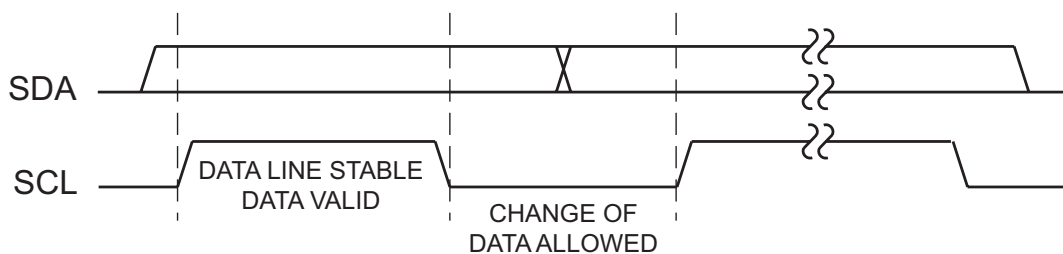

Figure 49. Start and Stop Conditions

BIT TRANSFER

One data bit is transferred during each clock pulse (Figure 50). The data on SDA must remain stable while SCL is high.

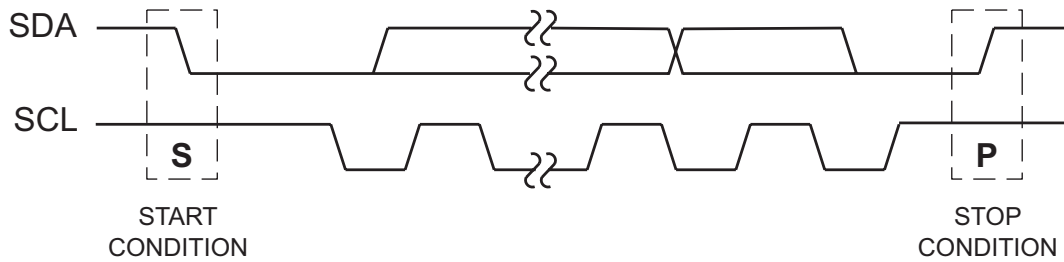

Figure 50. Bit Transfer

ACKNOWLEDGE

The acknowledge bit is a clocked 9th bit (Figure 51) which the recipient uses to handshake receipt of each byte of data. Thus each byte transferred effectively requires 9 bits. The master generates the 9th clock pulse, and the recipient pulls down SDA during the acknowledge clock pulse, such that the SDA line is stable low during the high period of the clock pulse. When the master is transmitting to the MPR121, the MPR121 generates the acknowledge bit, since the MPR121 is the recipient. When the MPR121 is transmitting to the master, the master generates the acknowledge bit, since the master is the recipient.

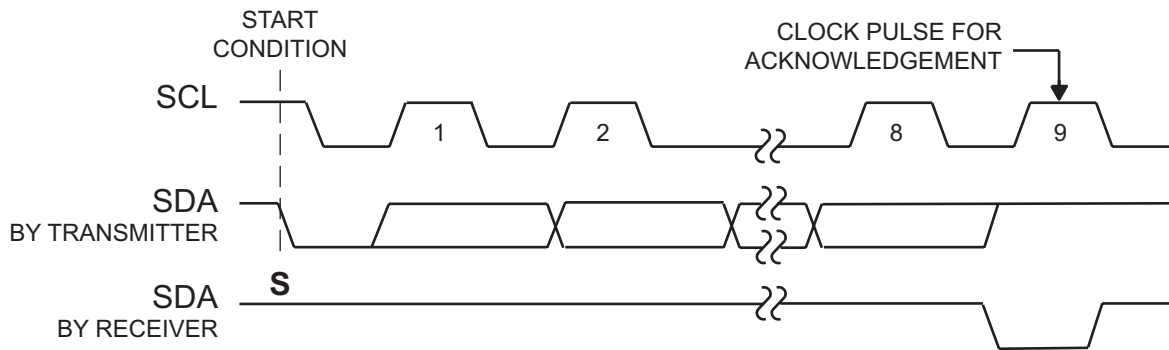

Figure 51. Acknowledge

THE SLAVE ADDRESS

The MPR121 has a 7-bit long slave address (Figure 52). The bit following the 7-bit slave address (bit eight) is the $\overline{R/W}$ bit, which is low for a write command and high for a read command.

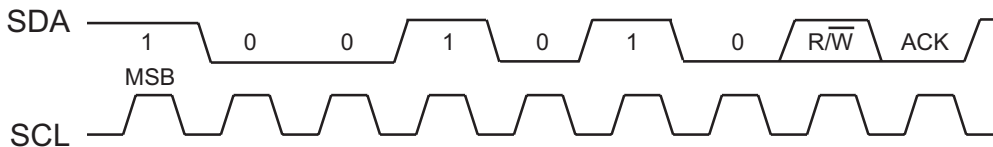

Figure 52. Slave Address

The MPR121 monitors the bus continuously, waiting for a START condition followed by its slave address. When a MPR121 recognizes its slave address, it acknowledges and is then ready for continued communication.

The MPR121 slave addresses are show in Table 46.

Table 46.

ADDR Pin Connection	I ² C Address
VDD	0x4C
VSS	0x4D
SDA	0x4E
SCL	0x4F

MESSAGE FORMAT FOR WRITING THE MPR121

A write to the MPR121 comprises the transmission of the MPR121's keystore slave address with the $\overline{R/\overline{W}}$ bit set to 0, followed by at least one byte of information. The first byte of information is the command byte. The command byte determines which register of the MPR121 is to be written by the next byte, if received. If a STOP condition is detected after the command byte is received, the MPR121 takes no further action (Figure 53) beyond storing the command byte. Any bytes received after the command byte are data bytes.

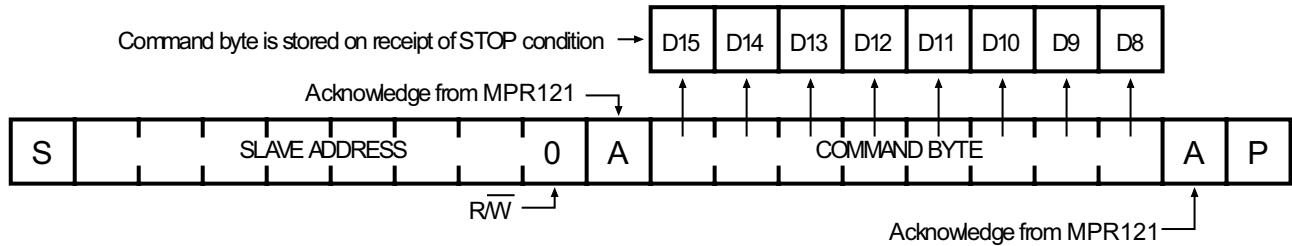

Figure 53. Command Byte Received

Any bytes received after the command byte are data bytes. The first data byte goes into the internal register of the MPR121 selected by the command byte (Figure 54).

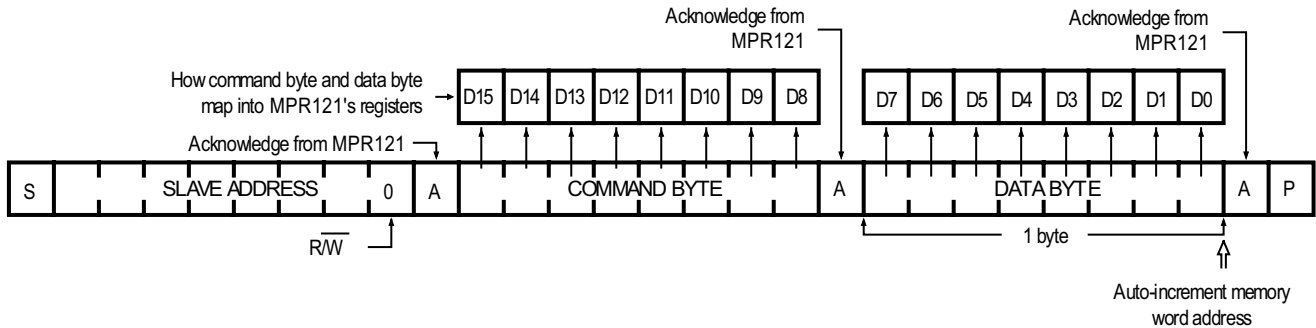

Figure 54. Command and Single Data Byte Received

If multiple data bytes are transmitted before a STOP condition is detected, these bytes are generally stored in subsequent MPR121 internal registers because the command byte address generally auto-increments.

MESSAGE FORMAT FOR READING THE MPR121

MPR121 is read using MPR121's internally stored register address as address pointer, the same way the stored register address is used as address pointer for a write. The pointer generally auto-increments after each data byte is read using the same rules as for a write. Thus, a read is initiated by first configuring MPR121's register address by performing a write (Figure 53) followed by a repeated start. The master can now read 'n' consecutive bytes from MPR121, with first data byte being read from the register addressed by the initialized register address.

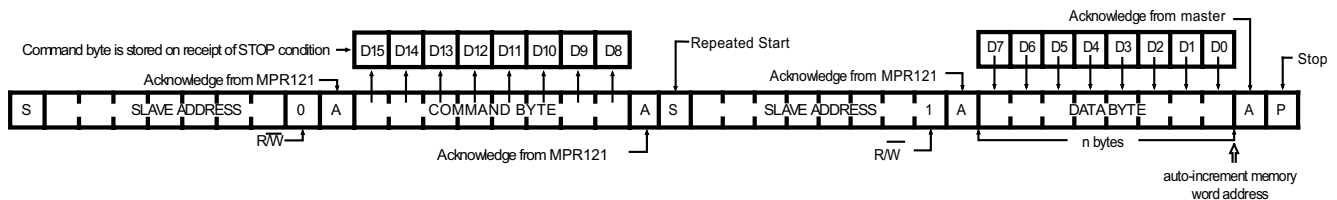

Figure 55. Reading MPR121

OPERATION WITH MULTIPLE MASTER

The application should use repeated starts to address the MPR121 to avoid bus confusion between I²C masters. On a I²C bus, once a master issues a start/repeated start condition, that master owns the bus until a stop condition occurs. If a master that does not own the bus attempts to take control of that bus, then improper addressing may occur. An address may always be rewritten to fix this problem. Follow I²C protocol for multiple master configurations.

AN3944: MPR121 Quick Start Guide

INTRODUCTION

The MPR121 is Freescale Semiconductor's top of the line touch sensor and can fit into a wide range of applications. These applications can all be accommodated by having a device with a very large range of flexibility. While all of these added features can allow for a wide range of flexibility, they can also add an unnecessary layer of complication. For advanced users who want to do more than basic touch detection, additional information can be found in other application notes.

To start, the device is configured through an I²C serial interface. The following table lists the registers that are initialized. The order they are written in is not significant except that register 0x05E, the Electrode Configuration Register must be written last.

Register Address	Register Name	Value	Application Note	Section
0x2B	MHD Rising	0x01	AN3891	A
0x2C	NHD Amount Rising	0x01	AN3891	A
0x2D	NCL Rising	0x00	AN3891	A
0x2E	FDL Rising	0x00	AN3891	A
0x2F	MHD Falling	0x01	AN3891	B
0x30	NHD Amount Falling	0x01	AN3891	B
0x31	NCL Falling	0xFF	AN3891	B
0x32	FDL Falling	0x02	AN3891	B
0x41	ELE0 Touch Threshold	0x0F	AN3892	C
0x42	ELE0 Release Threshold	0x0A	AN3892	C
0x43	ELE1 Touch Threshold	0x0F	AN3892	C
0x44	ELE1 Release Threshold	0x0A	AN3892	C
0x45	ELE2 Touch Threshold	0x0F	AN3892	C
0x46	ELE2 Release Threshold	0x0A	AN3892	C
0x47	ELE3 Touch Threshold	0x0F	AN3892	C
0x48	ELE3 Release Threshold	0x0A	AN3892	C
0x49	ELE4 Touch Threshold	0x0F	AN3892	C
0x4A	ELE4 Release Threshold	0x0A	AN3892	C
0x4B	ELE5 Touch Threshold	0x0F	AN3892	C
0x4C	ELE5 Release Threshold	0x0A	AN3892	C
0x4D	ELE6 Touch Threshold	0x0F	AN3892	C
0x4E	ELE6 Release Threshold	0x0A	AN3892	C
0x4F	ELE7 Touch Threshold	0x0F	AN3892	C
0x50	ELE7 Release Threshold	0x0A	AN3892	C
0x51	ELE8 Touch Threshold	0x0F	AN3892	C
0x52	ELE8 Release Threshold	0x0A	AN3892	C
0x53	ELE9 Touch Threshold	0x0F	AN3892	C
0x54	ELE9 Release Threshold	0x0A	AN3892	C
0x55	ELE10 Touch Threshold	0x0F	AN3892	C
0x56	ELE10 Release Threshold	0x0A	AN3892	C
0x57	ELE11 Touch Threshold	0x0F	AN3892	C
0x58	ELE11 Release Threshold	0x0A	AN3892	C
0x5D	Filter Configuration	0x04	AN3890	D
0x5E	Electrode Configuration	0x0C	AN3890	E
0x7B	AUTO-CONFIG Control Register 0	0x0B	AN3889	F

Register Address	Register Name	Value	Application Note	Section
0x7D	AUTO-CONFIG USL Register	0x9C	AN3889	F
0x7E	AUTO-CONFIG LSL Register	0x65	AN3889	F
0x7F	AUTO-CONFIG Target Level Register	0x8C	AN3889	F

The following sections describe what each of the defaults do and recommendations for variations.

Section A

Register Address	Register Name	Value	Application Note
0x2B	MHD Rising	0x01	AN3891
0x2C	NHD Amount Rising	0x01	AN3891
0x2D	NCL Rising	0x00	AN3891
0x2E	FDL Rising	0x00	AN3891

Description: This group of setting controls the filtering of the system when the data is greater than the baseline. The setting used allow the filter to act quickly and adjust for environmental changes. Additionally, if calibration happens to take place while a touch occurs, the value will self adjust very quickly. This auto-recovery or snap back prevents repeated false negative for a touch detection.

Variation: As the filter is sensitive to setting changes, it is recommended that users read AN3891 before changing the values. In most cases these default values will work

Section B

Register Address	Register Name	Value	Application Note
0x2F	MHD Falling	0x01	AN3891
0x30	NHD Amount Falling	0x01	AN3891
0x31	NCL Falling	0xFF	AN3891
0x32	FDL Falling	0x02	AN3891

Description: This group of setting controls the filtering of the system, when the data is less than the baseline. The settings slow down the filter as the negative charge is in the same direction as a touch. By slowing down the filter, touch signals are "rejected" by the baseline filter. While at the same time lon term environmental change that occur slower than at a touch are accepted. This low pass filter both allows for touches to be detected properly while preventing false positive by passing environmental change through the filter.

Variation: As the filter is sensitive to setting changes, it is recommended that users read AN3891 before changing the values. In most cases these default values will work

Section C

Register Address	Register Name	Value	Application Note
0x41	ELE0 Touch Threshold	0x0F	AN3892
0x42	ELE0 Release Threshold	0x0A	AN3892
0x43	ELE1 Touch Threshold	0x0F	AN3892
0x44	ELE1 Release Threshold	0x0A	AN3892
0x45	ELE2 Touch Threshold	0x0F	AN3892
0x46	ELE2 Release Threshold	0x0A	AN3892
0x47	ELE3 Touch Threshold	0x0F	AN3892
0x48	ELE3 Release Threshold	0x0A	AN3892
0x49	ELE4 Touch Threshold	0x0F	AN3892
0x4A	ELE4 Release Threshold	0x0A	AN3892
0x4B	ELE5 Touch Threshold	0x0F	AN3892
0x4C	ELE5 Release Threshold	0x0A	AN3892
0x4D	ELE6 Touch Threshold	0x0F	AN3892
0x4E	ELE6 Release Threshold	0x0A	AN3892
0x4F	ELE7 Touch Threshold	0x0F	AN3892
0x50	ELE7 Release Threshold	0x0A	AN3892
0x51	ELE8 Touch Threshold	0x0F	AN3892
0x52	ELE8 Release Threshold	0x0A	AN3892
0x53	ELE9 Touch Threshold	0x0F	AN3892
0x54	ELE9 Release Threshold	0x0A	AN3892
0x55	ELE10 Touch Threshold	0x0F	AN3892
0x56	ELE10 Release Threshold	0x0A	AN3892
0x57	ELE11 Touch Threshold	0x0F	AN3892
0x58	ELE11 Release Threshold	0x0A	AN3892

Description: The touch threshold registers set the minimum delta from the baseline when a touch is detected. 0x0F or 15 in decimal is an estimate of the minimum value for touch. Most electrodes will work with this value even if they vary greatly in size and shape. The value of 0x0A or 10 is the release threshold register allowed for hysteresis in the touch detection.

Variation: For very small electrodes, smaller values can be used and for very large electrodes the reverse is true. One easy method is to view the deltas actually seen in a system and set the touch at 80% and release at 70% of delta for good performance.

Section D

Register Address	Register Name	Value	Application Note
0x5D	Filter Configuration	0x04	AN3890

Description: There are three settings embedded in this register so it is only necessary to pay attention to one. The ESI controls the sample rate of the device. In the default, the setting used is 0x00 for 1 ms sample rate. Since the SFI is set to 00, resulting in 4 samples averaged, the response time will be 4 ms.

Variation: To save power, the 1 ms can be increased to 128 ms by increasing the setting to 0x07. The values are base 2 exponential thus 0x01 = 2 ms; 0x02 = 4 ms; and so on to 0x07 = 128 ms. Most of the time, 0x04 results in the best compromise between power consumption and response time.

Section E

Register Address	Register Name	Value	Application Note
0x5E	Electrode Configuration	0x0C	AN3890

Description: This register controls the number of electrodes being enabled and the mode the device is in. There are only two modes, Standby (when the value is 0x00) and Run (when the value of the lower bit is non-zero). The default value shown enables all 12 electrodes by writing decimal 12 or hex 0x0C to the register. Typically other registers cannot be changed while the part is running so this register should always be written last.

Variation: During debug of a system, this register will change between the number of electrodes and 0x00 every time a register needs to change. In a production system, this register will only need to be written when the mode is changed from Standby to Run or vice versa.

Section F

Register Address	Register Name	Value	Application Note
0x7B	AUTO-CONFIG Control Register 0	0x0B	AN3889
0x7D	AUTO-CONFIG USL Register	0x9C	AN3889
0x7E	AUTO-CONFIG LSL Register	0x65	AN3889
0x7F	AUTO-CONFIG Target Level Register	0x8C	AN3889

Description: These are the settings used for the Auto Configuration. They enable AUTO-CONFIG and AUTO_RECONFIG. In addition they set the target range for the baseline. The upper limit is set to 190, the target is set to 180 and the lower limit is set to 140.

Variation: In most cases these values will never need to be change, but if a case arises, a full description is found in application note AN3889.

CONCLUSION

In many applications for the MPR121, the default settings presented in this document will be sufficient for both design time activities as well as in the production implementation.

PACKAGE DIMENSIONS

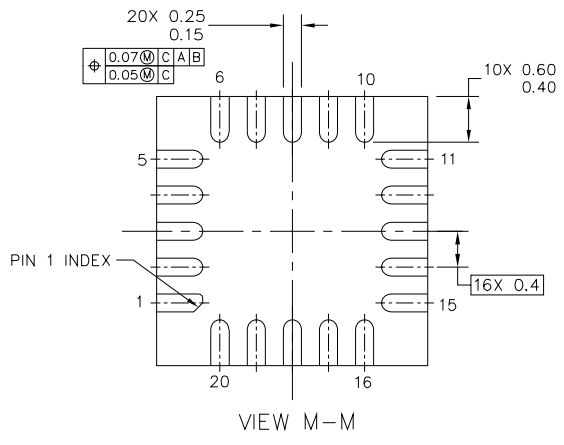
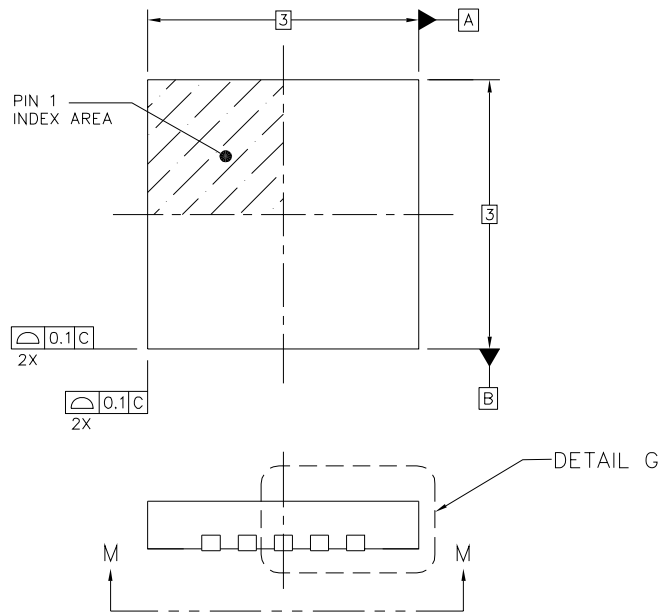

© FREESCALE SEMICONDUCTOR, INC. ALL RIGHTS RESERVED.	MECHANICAL OUTLINE	PRINT VERSION NOT TO SCALE	
TITLE: QUAD FLAT NO LEAD COL PACKAGE (QFN-COL) 20 TERMINAL, 0.4 PITCH (3 X 3 X 0.6)	DOCUMENT NO: 98ASA00021D	REV: 0	
	CASE NUMBER: 2059-01	19 FEB 2009	
	STANDARD: NON JEDEC		

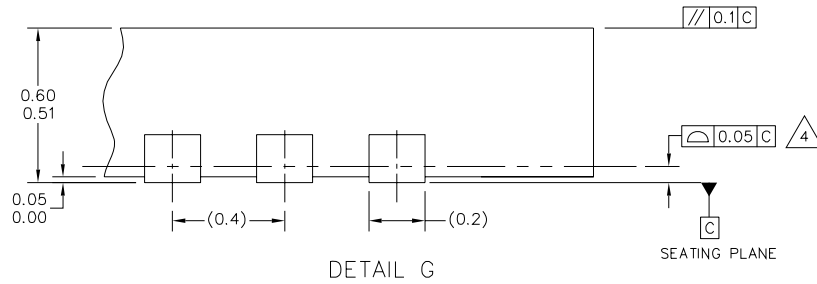

© FREESCALE SEMICONDUCTOR, INC. ALL RIGHTS RESERVED.	MECHANICAL OUTLINE	PRINT VERSION NOT TO SCALE	
TITLE: QUAD FLAT NO LEAD COL PACKAGE (QFN-COL) 20 TERMINAL, 0.4 PITCH (3 X 3 X 0.6)	DOCUMENT NO: 98ASA00021D	REV: 0	
	CASE NUMBER: 2059-01	19 FEB 2009	
	STANDARD: NON JEDEC		

PAGE 2 OF 3

PACKAGE DIMENSIONS

NOTES:

1. ALL DIMENSIONS ARE IN MILLIMETERS.
2. INTERPRET DIMENSIONS AND TOLERANCES PER ASME Y14.5M-1994.
3. THIS IS NON JEDEC REGISTERED PACKAGE.
4.  COPLANARITY APPLIES TO LEADS AND ALL OTHR BOTTOM SURFACE METALLIZATION.
5. MIN. METAL GAP SHOULD BE 0.2MM.

© FREESCALE SEMICONDUCTOR, INC. ALL RIGHTS RESERVED.	MECHANICAL OUTLINE	PRINT VERSION NOT TO SCALE	
TITLE: QUAD FLAT NO LEAD COL PACKAGE (QFN-COL) 20 TERMINAL, 0.4 PITCH (3 X 3 X 0.6)	DOCUMENT NO: 98ASA00021D	REV: 0	
	CASE NUMBER: 2059-01	19 FEB 2009	
	STANDARD: NON JEDEC		

PAGE 3 OF 3

How to Reach Us:

Home Page:

www.freescale.com

Web Support:

<http://www.freescale.com/support>

USA/Europe or Locations Not Listed:

Freescale Semiconductor, Inc.
Technical Information Center, EL516
2100 East Elliot Road
Tempe, Arizona 85284
1-800-521-6274 or +1-480-768-2130
www.freescale.com/support

Europe, Middle East, and Africa:

Freescale Halbleiter Deutschland GmbH
Technical Information Center
Schatzbogen 7
81829 Muenchen, Germany
+44 1296 380 456 (English)
+46 8 52200080 (English)
+49 89 92103 559 (German)
+33 1 69 35 48 48 (French)
www.freescale.com/support

Japan:

Freescale Semiconductor Japan Ltd.
Headquarters
ARCO Tower 15F
1-8-1, Shimo-Meguro, Meguro-ku,
Tokyo 153-0064
Japan
0120 191014 or +81 3 5437 9125
support.japan@freescale.com

Asia/Pacific:

Freescale Semiconductor China Ltd.
Exchange Building 23F
No. 118 Jianguo Road
Chaoyang District
Beijing 100022
China
+86 010 5879 8000
support.asia@freescale.com

For Literature Requests Only:

Freescale Semiconductor Literature Distribution Center
1-800-441-2447 or +1-303-675-2140
Fax: +1-303-675-2150
LDCForFreescaleSemiconductor@hibbertgroup.com

Information in this document is provided solely to enable system and software implementers to use Freescale Semiconductor products. There are no express or implied copyright licenses granted hereunder to design or fabricate any integrated circuits or integrated circuits based on the information in this document.

Freescale Semiconductor reserves the right to make changes without further notice to any products herein. Freescale Semiconductor makes no warranty, representation or guarantee regarding the suitability of its products for any particular purpose, nor does Freescale Semiconductor assume any liability arising out of the application or use of any product or circuit, and specifically disclaims any and all liability, including without limitation consequential or incidental damages. "Typical" parameters that may be provided in Freescale Semiconductor data sheets and/or specifications can and do vary in different applications and actual performance may vary over time. All operating parameters, including "Typicals", must be validated for each customer application by customer's technical experts. Freescale Semiconductor does not convey any license under its patent rights nor the rights of others. Freescale Semiconductor products are not designed, intended, or authorized for use as components in systems intended for surgical implant into the body, or other applications intended to support or sustain life, or for any other application in which the failure of the Freescale Semiconductor product could create a situation where personal injury or death may occur. Should Buyer purchase or use Freescale Semiconductor products for any such unintended or unauthorized application, Buyer shall indemnify and hold Freescale Semiconductor and its officers, employees, subsidiaries, affiliates, and distributors harmless against all claims, costs, damages, and expenses, and reasonable attorney fees arising out of, directly or indirectly, any claim of personal injury or death associated with such unintended or unauthorized use, even if such claim alleges that Freescale Semiconductor was negligent regarding the design or manufacture of the part.

Freescale and the Freescale logo are trademarks of Freescale Semiconductor, Inc. All other product or service names are the property of their respective owners.

© Freescale Semiconductor, Inc. 2010. All rights reserved.

RoHS-compliant and/or Pb-free versions of Freescale products have the functionality and electrical characteristics of their non-RoHS-compliant and/or non-Pb-free counterparts. For further information, see <http://www.freescale.com> or contact your Freescale sales representative.

For information on Freescale's Environmental Products program, go to <http://www.freescale.com/epp>.