

DATA SHEET

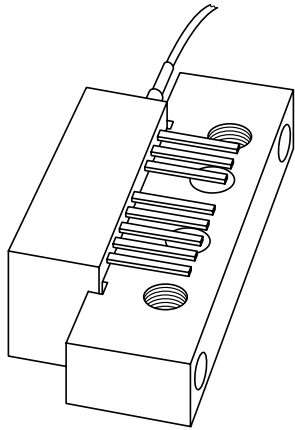

**BGE847BO; BGE847BO/FC0;
BGE847BO/SC0**

Optical receiver modules

Product specification
Supersedes data of 2000 Feb 02

2000 Apr 04

Optical receiver modules

BGE847BO; BGE847BO/FC0; BGE847BO/SC0

FEATURES

- Excellent linearity
- Low noise
- Excellent flatness
- Standard CATV outline
- Rugged construction
- Gold metallization ensures excellent reliability
- High optical input power range.

APPLICATIONS

CATV optical node systems operating in the 40 to 870 MHz frequency range.

DESCRIPTION

High dynamic range optical receiver amplifier modules in a standard SOT115 package where the non-jacketed fibre has either no connector or has an FC/APC or SC/APC connector.

The amplifier supply voltage pin and the photo diode bias voltage pin both connect to 24 V (DC).

The modules have a monomode optical input suitable for 1290 to 1600 nm wavelengths, a terminal to monitor the photo diode current and an electrical output having a characteristic impedance of 75 Ω.

PINNING

PIN	DESCRIPTION
1	monitor current
2	common
3	common
4	+V _B of the photo diode
5	+V _B of the amplifier
7	common
8	common
9	output

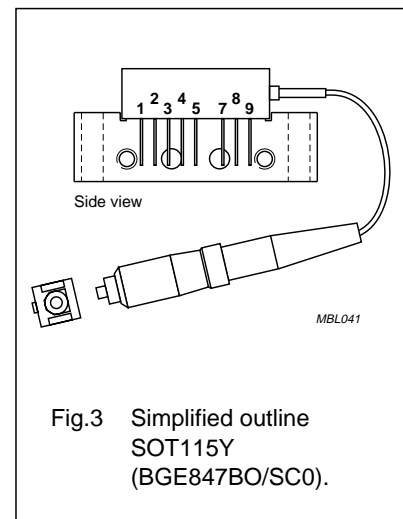
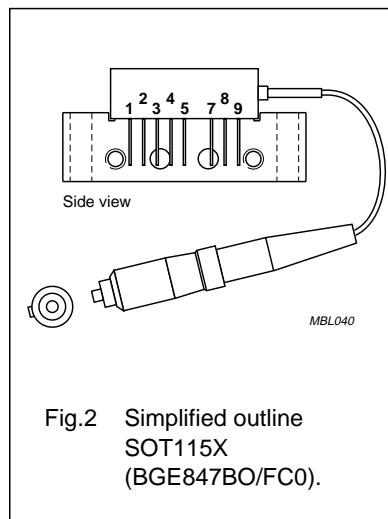
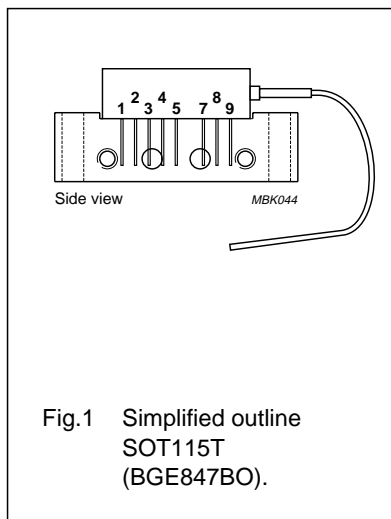

QUICK REFERENCE DATA

SYMBOL	PARAMETER	CONDITIONS	MIN.	MAX.	UNIT
f	frequency range		40	870	MHz
S ₂₂	output return losses	f = 40 to 870 MHz	11	–	dB
	optical input return losses		45	–	dB
d ₂	second order distortion	f = 854.5 MHz	–	–57	dBc
F	equivalent noise input	f = 40 to 450 MHz	–	7	pA/√Hz
I _{tot}	total current consumption (DC)	V _B = 24 V	175	205	mA

HANDLING

Fiberglass optical coupling: maximum tensile strength = 5 N; minimum bending radius = 35 mm.

Optical receiver modules

BGE847BO; BGE847BO/FC0;
BGE847BO/SC0**LIMITING VALUES**

In accordance with the Absolute Maximum Rating System (IEC 60134).

SYMBOL	PARAMETER	CONDITIONS	MIN.	MAX.	UNIT
f	frequency range		40	870	MHz
T _{stg}	storage temperature		-40	+85	°C
T _{mb}	operating mounting base temperature		-20	+85	°C
P _{in}	optical input power	continuous	-	5	mW
ESD	ESD sensitivity	human body model; R = 1.5 kΩ; C = 100 pF	500	-	V

CHARACTERISTICSBandwidth 40 to 870 MHz; V_B = 24 V; T_{mb} = 30 °C; Z_S = Z_L = 75 Ω.

SYMBOL	PARAMETER	CONDITIONS	MIN.	MAX.	UNIT
S	responsivity BGE847BO BGE847BO/FC0, BGE847BO/SC0	λ = 1300 nm	800	-	V/W
			750	-	V/W
FL	flatness straight line (peak to valley)	f = 40 to 870 MHz	-	1	dB
S ₂₂	output return losses optical input return losses	f = 40 to 870 MHz	11	-	dB
			45	-	dB
d ₂	second order distortion	f _m = 446.5 MHz; notes 1 and 3	-	-68	dB
		f _m = 746.5 MHz; notes 1 and 4		-63	dB
		f _m = 854.5 MHz; notes 1 and 5		-57	dB
d ₃	third order distortion	f _m = 853.25 MHz; notes 2 and 6	-	-75	dB
F	equivalent noise input	f = 40 to 450 MHz	-	7	pA/√Hz
		f = 450 to 750 MHz	-	9	pA/√Hz
		f = 750 to 870 MHz	-	10.5	pA/√Hz
S _λ	spectral sensitivity	λ = 1310 ±20 nm	0.85	-	A/W
		λ = 1550 ±20 nm	0.9	-	A/W
λ	optical wavelength		1290	1600	nm
L	length of optical fibre BGE847BO BGE847BO/FC0, BGE847BO/SC0	fibre; SM type; 9/125 μm	1	-	m
			746	861	mm
I _{tot}	total current consumption (DC)		175	205	mA
I _{pin 4}	photo diode bias current (DC)		-	25	mA

Optical receiver modules

BGE847BO; BGE847BO/FC0;
BGE847BO/SC0**Notes**

1. Two laser test; each laser with a modulation index of 40%; $P_{opt} = 1$ mW (total).
2. Three laser test; each laser with a modulation index of 60%; $P_{opt} = 1$ mW (total).
3. $f_m = 446.5$ MHz; $f_p = 97.25$ MHz; $f_q = 349.25$ MHz.
4. $f_m = 746.5$ MHz; $f_p = 133.25$ MHz; $f_q = 613.25$ MHz.
5. $f_m = 854.5$ MHz; $f_p = 133.25$ MHz; $f_q = 721.25$ MHz.
6. $f_m = 853.25$ MHz; $f_p = 133.25$ MHz; $f_q = 265.25$ MHz; $f_r = 721.25$ MHz.

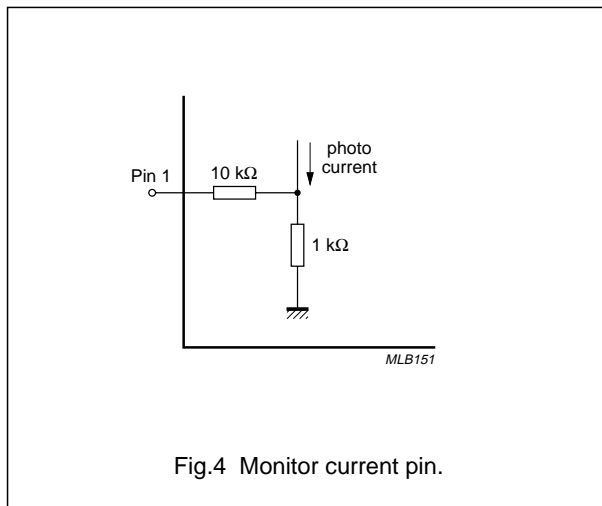

Optical receiver modules

BGE847BO; BGE847BO/FC0;
BGE847BO/SC0

PACKAGE OUTLINES

Rectangular single-ended package; aluminium flange; 2 vertical mounting holes;
2 x 6-32 UNC and 2 extra horizontal mounting holes; optical input; 8 gold-plated in-line leads

SOT115T

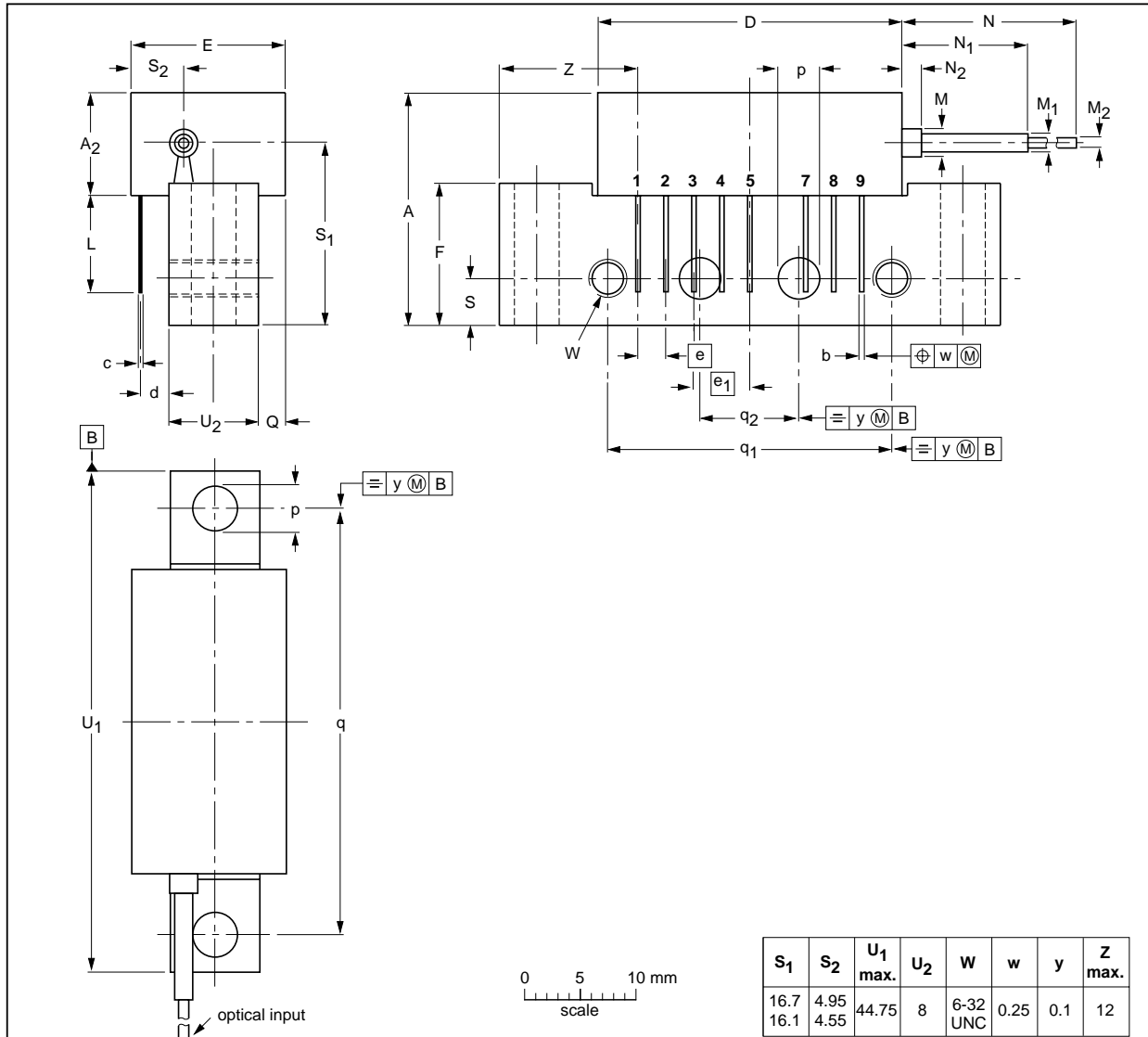

DIMENSIONS (mm are the original dimensions)

UNIT	A max.	A ₂ max.	b	c	D max.	d max.	E max.	e	e ₁	F	L min.	M	M ₁	M ₂	N min.	N ₁	N ₂	p	Q max.	q	q ₁	q ₂	S
mm	20.8	9.1	0.51 0.38	0.25	27.2	2.54	13.75	2.54	5.08	12.7	8.8	2.5	1.6	0.9	1000	10.7 8.7	5 1	4.15 3.85	2.4	38.1	25.4	10.2	4.2

OUTLINE VERSION	REFERENCES				EUROPEAN PROJECTION	ISSUE DATE
	IEC	JEDEC	EIAJ			
SOT115T						99-04-13

Optical receiver modules

BGE847BO; BGE847BO/FC0;
BGE847BO/SC0

Rectangular single-ended package; aluminium flange;
2 vertical mounting holes; 2 x 6-32 UNC and 2 extra horizontal mounting holes;
optical input with connector; 8 gold-plated in-line leads

SOT115X

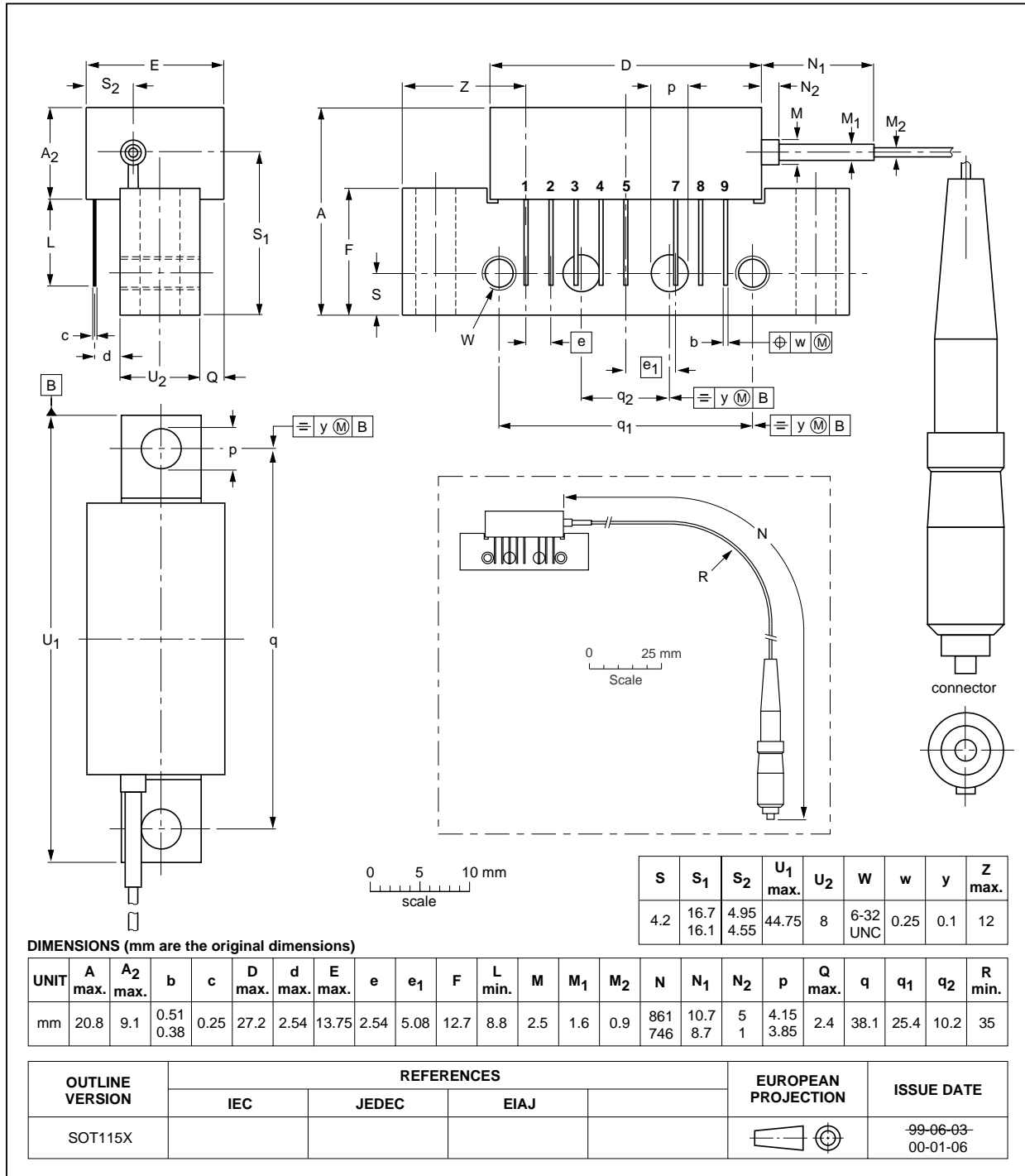

Optical receiver modules

BGE847BO; BGE847BO/FC0;
BGE847BO/SC0

Rectangular single-ended package; aluminium flange;
2 vertical mounting holes; 2 x 6-32 UNC and 2 extra horizontal mounting holes;
optical input with connector; 8 gold-plated in-line leads

SOT115Y

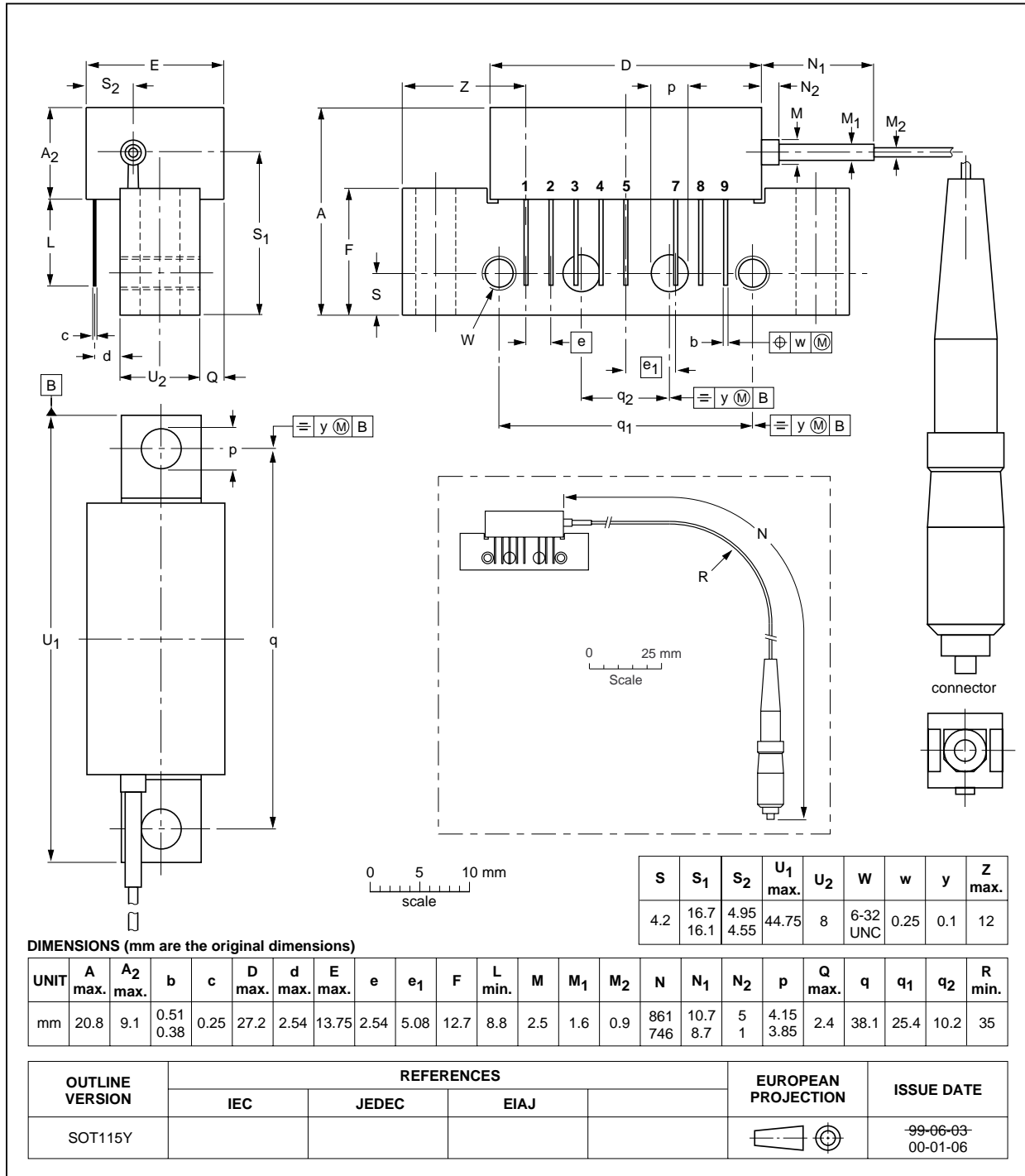

Optical receiver modules

BGE847BO; BGE847BO/FC0;
BGE847BO/SC0

DATA SHEET STATUS

DATA SHEET STATUS	PRODUCT STATUS	DEFINITIONS ⁽¹⁾
Objective specification	Development	This data sheet contains the design target or goal specifications for product development. Specification may change in any manner without notice.
Preliminary specification	Qualification	This data sheet contains preliminary data, and supplementary data will be published at a later date. Philips Semiconductors reserves the right to make changes at any time without notice in order to improve design and supply the best possible product.
Product specification	Production	This data sheet contains final specifications. Philips Semiconductors reserves the right to make changes at any time without notice in order to improve design and supply the best possible product.

Note

1. Please consult the most recently issued data sheet before initiating or completing a design.

DEFINITIONS

Short-form specification — The data in a short-form specification is extracted from a full data sheet with the same type number and title. For detailed information see the relevant data sheet or data handbook.

Limiting values definition — Limiting values given are in accordance with the Absolute Maximum Rating System (IEC 60134). Stress above one or more of the limiting values may cause permanent damage to the device. These are stress ratings only and operation of the device at these or at any other conditions above those given in the Characteristics sections of the specification is not implied. Exposure to limiting values for extended periods may affect device reliability.

Application information — Applications that are described herein for any of these products are for illustrative purposes only. Philips Semiconductors make no representation or warranty that such applications will be suitable for the specified use without further testing or modification.

DISCLAIMERS

Life support applications — These products are not designed for use in life support appliances, devices, or systems where malfunction of these products can reasonably be expected to result in personal injury. Philips Semiconductors customers using or selling these products for use in such applications do so at their own risk and agree to fully indemnify Philips Semiconductors for any damages resulting from such application.

Right to make changes — Philips Semiconductors reserves the right to make changes, without notice, in the products, including circuits, standard cells, and/or software, described or contained herein in order to improve design and/or performance. Philips Semiconductors assumes no responsibility or liability for the use of any of these products, conveys no licence or title under any patent, copyright, or mask work right to these products, and makes no representations or warranties that these products are free from patent, copyright, or mask work right infringement, unless otherwise specified.

CAUTION

This product is supplied in anti-static packing to prevent damage caused by electrostatic discharge during transport and handling. For further information, refer to Philips specs.: SNW-EQ-608, SNW-FQ-302A and SNW-FQ-302B.

Optical receiver modules

BGE847BO; BGE847BO/FC0;
BGE847BO/SC0

NOTES

Optical receiver modules

BGE847BO; BGE847BO/FC0;
BGE847BO/SC0

NOTES

Optical receiver modules

BGE847BO; BGE847BO/FC0;
BGE847BO/SC0

NOTES

Philips Semiconductors – a worldwide company

Argentina: see South America

Australia: 3 Figtree Drive, HOMEBUSH, NSW 2140,
Tel. +61 2 9704 8141, Fax. +61 2 9704 8139

Austria: Computerstr. 6, A-1101 WIEN, P.O. Box 213,
Tel. +43 1 60 101 1248, Fax. +43 1 60 101 1210

Belarus: Hotel Minsk Business Center, Bld. 3, r. 1211, Volodarski Str. 6,
220050 MINSK, Tel. +375 172 20 0733, Fax. +375 172 20 0773

Belgium: see The Netherlands

Brazil: see South America

Bulgaria: Philips Bulgaria Ltd., Energoproject, 15th floor,
51 James Bourchier Blvd., 1407 SOFIA,
Tel. +359 2 68 9211, Fax. +359 2 68 9102

Canada: PHILIPS SEMICONDUCTORS/COMPONENTS,
Tel. +1 800 234 7381, Fax. +1 800 943 0087

China/Hong Kong: 501 Hong Kong Industrial Technology Centre,
72 Tat Chee Avenue, Kowloon Tong, HONG KONG,
Tel. +852 2319 7888, Fax. +852 2319 7700

Colombia: see South America

Czech Republic: see Austria

Denmark: Sydhavnsgade 23, 1780 COPENHAGEN V,
Tel. +45 33 29 3333, Fax. +45 33 29 3905

Finland: Sinikalliontie 3, FIN-02630 ESPOO,
Tel. +358 9 615 800, Fax. +358 9 6158 0920

France: 51 Rue Carnot, BP317, 92156 SURESNES Cedex,
Tel. +33 1 4099 6161, Fax. +33 1 4099 6427

Germany: Hammerbrookstraße 69, D-20097 HAMBURG,
Tel. +49 40 2353 60, Fax. +49 40 2353 6300

Hungary: see Austria

India: Philips INDIA Ltd, Band Box Building, 2nd floor,
254-D, Dr. Annie Besant Road, Worli, MUMBAI 400 025,
Tel. +91 22 493 8541, Fax. +91 22 493 0966

Indonesia: PT Philips Development Corporation, Semiconductors Division,
Gedung Philips, Jl. Buncit Raya Kav.99-100, JAKARTA 12510,
Tel. +62 21 794 0040 ext. 2501, Fax. +62 21 794 0080

Ireland: Newstead, Clonskeagh, DUBLIN 14,
Tel. +353 1 7640 000, Fax. +353 1 7640 200

Israel: RAPAC Electronics, 7 Kehilat Saloniki St, PO Box 18053,
TEL AVIV 61180, Tel. +972 3 645 0444, Fax. +972 3 649 1007

Italy: PHILIPS SEMICONDUCTORS, Via Casati, 23 - 20052 MONZA (MI),
Tel. +39 039 203 6838, Fax +39 039 203 6800

Japan: Philips Bldg 13-37, Kohnan 2-chome, Minato-ku,
TOKYO 108-8507, Tel. +81 3 3740 5130, Fax. +81 3 3740 5057

Korea: Philips House, 260-199 Itaewon-dong, Yongsan-ku, SEOUL,
Tel. +82 2 709 1412, Fax. +82 2 709 1415

Malaysia: No. 76 Jalan Universiti, 46200 PETALING JAYA, SELANGOR,
Tel. +60 3 750 5214, Fax. +60 3 757 4880

Mexico: 5900 Gateway East, Suite 200, EL PASO, TEXAS 79905,
Tel. +9-5 800 234 7381, Fax +9-5 800 943 0087

Middle East: see Italy

Netherlands: Postbus 90050, 5600 PB EINDHOVEN, Bldg. VB,
Tel. +31 40 27 82785, Fax. +31 40 27 88399

New Zealand: 2 Wagener Place, C.P.O. Box 1041, AUCKLAND,
Tel. +64 9 849 4160, Fax. +64 9 849 7811

Norway: Box 1, Manglerud 0612, OSLO,
Tel. +47 22 74 8000, Fax. +47 22 74 8341

Pakistan: see Singapore

Philippines: Philips Semiconductors Philippines Inc.,
106 Valero St. Salcedo Village, P.O. Box 2108 MCC, MAKATI,
Metro MANILA, Tel. +63 2 816 6380, Fax. +63 2 817 3474

Poland: Al.Jerozolimskie 195 B, 02-222 WARSAW,
Tel. +48 22 5710 000, Fax. +48 22 5710 001

Portugal: see Spain

Romania: see Italy

Russia: Philips Russia, Ul. Usatcheva 35A, 119048 MOSCOW,
Tel. +7 095 755 6918, Fax. +7 095 755 6919

Singapore: Lorong 1, Toa Payoh, SINGAPORE 319762,
Tel. +65 350 2538, Fax. +65 251 6500

Slovakia: see Austria

Slovenia: see Italy

South Africa: S.A. PHILIPS Pty Ltd., 195-215 Main Road Martindale,
2092 JOHANNESBURG, P.O. Box 58088 Newville 2114,
Tel. +27 11 471 5401, Fax. +27 11 471 5398

South America: Al. Vicente Pinzon, 173, 6th floor,
04547-130 SÃO PAULO, SP, Brazil,
Tel. +55 11 821 2333, Fax. +55 11 821 2382

Spain: Balmes 22, 08007 BARCELONA,
Tel. +34 93 301 6312, Fax. +34 93 301 4107

Sweden: Kottbygatan 7, Akalla, S-16485 STOCKHOLM,
Tel. +46 8 5985 2000, Fax. +46 8 5985 2745

Switzerland: Allmendstrasse 140, CH-8027 ZÜRICH,
Tel. +41 1 488 2741 Fax. +41 1 488 3263

Taiwan: Philips Semiconductors, 6F, No. 96, Chien Kuo N. Rd., Sec. 1,
TAIPEI, Taiwan Tel. +886 2 2134 2886, Fax. +886 2 2134 2874

Thailand: PHILIPS ELECTRONICS (THAILAND) Ltd.,
209/2 Sanpavuth-Bangna Road Prakanong, BANGKOK 10260,
Tel. +66 2 745 4090, Fax. +66 2 398 0793

Turkey: Yukari Dudullu, Org. San. Blg., 2.Cad. Nr. 28 81260 Umraniye,
ISTANBUL, Tel. +90 216 522 1500, Fax. +90 216 522 1813

Ukraine: PHILIPS UKRAINE, 4 Patrice Lumumba str., Building B, Floor 7,
252042 KIEV, Tel. +380 44 264 2776, Fax. +380 44 268 0461

United Kingdom: Philips Semiconductors Ltd., 276 Bath Road, Hayes,
MIDDLESEX UB3 5BX, Tel. +44 208 730 5000, Fax. +44 208 754 8421

United States: 811 East Arques Avenue, SUNNYVALE, CA 94088-3409,
Tel. +1 800 234 7381, Fax. +1 800 943 0087

Uruguay: see South America

Vietnam: see Singapore

Yugoslavia: PHILIPS, Trg N. Pasica 5/v, 11000 BEOGRAD,
Tel. +381 11 3341 299, Fax.+381 11 3342 553

For all other countries apply to: Philips Semiconductors,
International Marketing & Sales Communications, Building BE-p, P.O. Box 218,
5600 MD EINDHOVEN, The Netherlands, Fax. +31 40 27 24825

Internet: <http://www.semiconductors.philips.com>

© Philips Electronics N.V. 2000

SCA 69

All rights are reserved. Reproduction in whole or in part is prohibited without the prior written consent of the copyright owner.

The information presented in this document does not form part of any quotation or contract, is believed to be accurate and reliable and may be changed without notice. No liability will be accepted by the publisher for any consequence of its use. Publication thereof does not convey nor imply any license under patent- or other industrial or intellectual property rights.

Printed in The Netherlands

603510/04/pp12

Date of release: 2000 Apr 04

Document order number: 9397 750 06872

Let's make things better.

**Philips
Semiconductors**



PHILIPS