

## LMC6582 Dual/LMC6584 Quad Low Voltage, Rail-To-Rail Input and Output CMOS Operational Amplifier

### General Description

The LMC6582/4 is a high performance operational amplifier which can operate over a wide range of supply voltages with guaranteed specifications at 1.8V, 2.2V, 3V, 5V, and 10V.

The LMC6582/4 provides an input common-mode voltage range that exceeds both supplies. The rail-to-rail output swing of the amplifier assures maximum dynamic signal range. This rail-to-rail performance of the amplifier, combined with its high open-loop voltage gain makes it unique among rail-to-rail CMOS amplifiers. The LMC6582/4 is an excellent choice for circuits where the input common-mode voltage range is a concern.

The LMC6582/4 has been designed specifically to improve system performance in low voltage applications. Guaranteed operation down to 1.8V means that this family of amplifiers can operate at the end of discharge (EOD) voltages of several popular batteries. The amplifier's 80 fA input current, 0.5 mV offset voltage, and 82 dB CMRR maintain accuracy in battery-powered systems.

For a single, dual or quad CMOS amplifier with similar specs and a powerdown mode, refer to the LMC6681/2/4 datasheet.

### Features

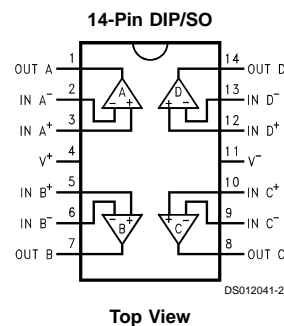
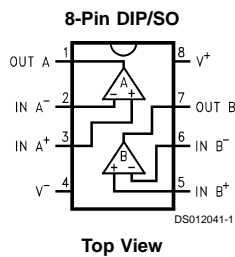
(Typical unless otherwise noted)

- Guaranteed Specs at 1.8V, 2.2V, 3V, 5V, 10V
- Rail-to-Rail Input Common-Mode Voltage Range
- Rail-to-Rail Output Swing  
(within 10 mV of supply rail, @  $V_S = 3V$  and  $R_L = 10\text{ k}\Omega$ )
- CMRR and PSRR: 82 dB
- Ultra Low Input Current: 80 fA
- High Voltage Gain ( $V_S = 3V$ ,  $R_L = 10\text{ k}\Omega$ ): 120 dB
- Unity Gain Bandwidth: 1.2 MHz

### Applications

- Battery Operated Systems
- Sensor Amplifiers
- Portable Communication Devices
- Medical Instrumentation
- Level Detectors, Sample-and-Hold Circuits
- Battery Monitoring

### Connection Diagrams



## Ordering Information

Package	Temperature Range Industrial, -40°C to +85°C	NSC Drawing	Transport Media
8-pin Molded DIP	LMC6582AIN, LMC6582BIN	N08E	Rails
8-pin Small Outline	LMC6582AIM, LMC6582BIM LMC6582AIMX, LMC6582BIMX	M08A M08A	Rails Tape and Reel
14-pin Molded DIP	LMC6584AIN, LMC6584BIN	N14A	Rails
14-pin Small Outline	LMC6584AIM, LMC6584BIM LMC6584AIMX, LMC6584BIMX	M14A M14A	Rails Tape and Reel

## Absolute Maximum Ratings (Note 1)

If Military/Aerospace specified devices are required, please contact the National Semiconductor Sales Office/Distributors for availability and specifications.

ESD Tolerance (Note 2)	2 kV
Differential Input Voltage	$\pm$ Supply Voltage
Voltage at Input/Output Pin	(V <sup>+</sup> ) +0.3V, (V <sup>-</sup> ) -0.3V
Supply Voltage (V <sup>+</sup> - V <sup>-</sup> )	12V
Current at Input Pin (Note 11)	$\pm$ 5 mA
Current at Output Pin (Note 3)	$\pm$ 30 mA
Current at Power Supply Pin	35 mA
Lead Temp. (soldering, 10 sec.)	260°C
Storage Temperature Range	-65°C to +150°C

Junction Temperature (Note 4)

150°C

## Operating Ratings (Note 1)

Supply Voltage	$1.8V \leq V_S \leq 10V$
Junction Temperature Range	
LMC6582AI, LMC6582BI	$-40^\circ\text{C} \leq T_J \leq +85^\circ\text{C}$
LMC6584AI, LMC6584BI	$-40^\circ\text{C} \leq T_J \leq +85^\circ\text{C}$
Thermal Resistance ( $\theta_{JA}$ )	
N Package, 8-pin Molded DIP	108°C/W
M Package, 8-pin Surface Mount	172°C/W
N Package, 14-pin Molded DIP	88°C/W
M Package, 14-pin Surface Mount	126°C/W

## 3V DC Electrical Characteristics

Unless otherwise specified, all limits guaranteed for  $T_J = 25^\circ\text{C}$ ,  $V^+ = 3.0V$ ,  $V^- = 0V$ ,  $V_{CM} = V_O = V^+/2$  and  $R_L > 1\text{ M}\Omega$ . **Bold-face** limits apply at the temperature extremes.

Symbol	Parameter	Conditions	Typ (Note 5)	LMC6582AI	LMC6582BI	Units
				LMC6584AI Limit (Note 6)	LMC6584BI Limit (Note 6)	
$V_{OS}$	Input Offset Voltage		0.5	1 <b>2.5</b>	3 <b>4.5</b>	mV max
$TCV_{OS}$	Input Offset Voltage Average Drift		1.5			$\mu\text{V}/^\circ\text{C}$
$I_B$	Input Current	(Note 12)	0.08	<b>20</b>	<b>20</b>	pA max
$I_{OS}$	Input Offset Current	(Note 12)	0.04	<b>10</b>	<b>10</b>	pA max
$R_{IN}$	Input Resistance		>1			Tera $\Omega$
$C_{IN}$	Input Capacitance		3			pF
CMRR	Common Mode Rejection Ratio	(Note 13)	82	70 <b>65</b>	65 <b>62</b>	dB min
PSRR	Power Supply Rejection Ratio	$\pm 1.5V \leq V_S \leq \pm 2.5V$ $V_O = V^+/2 = V_{CM}$	82	70 <b>65</b>	65 <b>62</b>	dB min
$V_{CM}$	Input Common Mode Voltage Range	CMRR > 50 dB	3.23	3.18 <b>3.00</b>	3.18 <b>3.00</b>	V min
			-0.3	-0.18 <b>0.00</b>	-0.18 <b>0.00</b>	V max
$A_V$	Large Signal Voltage Gain	$R_L = 600\Omega$ (Notes 7, 12)	70	10	10	V/mV
		$R_L = 10\text{ k}\Omega$ (Notes 7, 12)	1000	12	12	V/mV
$V_O$	Output Swing	$R_L = 600\Omega$ to $V^+/2$	2.87	2.70 <b>2.58</b>	2.70 <b>2.58</b>	V min
			0.15	0.3 <b>0.42</b>	0.3 <b>0.42</b>	V max
		$R_L = 2\text{ k}\Omega$ to $V^+/2$	2.95	2.85 <b>2.79</b>	2.85 <b>2.79</b>	V min
			0.05	0.15 <b>0.21</b>	0.15 <b>0.21</b>	V max
		$R_L = 10\text{ k}\Omega$ to $V^+/2$	2.99	2.94 <b>2.91</b>	2.94 <b>2.91</b>	V min
			0.01	0.04 <b>0.05</b>	0.04 <b>0.05</b>	V max

### 3V DC Electrical Characteristics (Continued)

Unless otherwise specified, all limits guaranteed for  $T_J = 25^\circ\text{C}$ ,  $V^+ = 3.0\text{V}$ ,  $V^- = 0\text{V}$ ,  $V_{\text{CM}} = V_O = V^+/2$  and  $R_L > 1\text{ M}\Omega$ . **Boldface** limits apply at the temperature extremes.

Symbol	Parameter	Conditions	Typ (Note 5)	LMC6582AI LMC6584AI Limit (Note 6)	LMC6582BI LMC6584BI Limit (Note 6)	Units
$I_{\text{SC}}$	Output Short Circuit Current	Sourcing, $V_O = 0\text{V}$	20	9.0 <b>6.7</b>	9.0 <b>6.7</b>	mA min
		Sinking, $V_O = 3\text{V}$	12	6.0 <b>4.5</b>	6.0 <b>4.5</b>	mA min
$I_S$	Supply Current	Dual, LMC6582 $V_{\text{CM}} = 1.5\text{V}$	1.4	2.26 <b>2.75</b>	2.26 <b>2.75</b>	mA max
		Quad, LMC6584 $V_{\text{CM}} = 1.5\text{V}$	2.8	4.52 <b>5.42</b>	4.52 <b>5.42</b>	mA max

### 1.8V and 2.2V DC Electrical Characteristics

Unless otherwise specified, all limits guaranteed for  $T_J = 25^\circ\text{C}$ ,  $V^+ = 1.8\text{V}$  and  $2.2\text{V}$ ,  $V^- = 0\text{V}$ ,  $V_{\text{CM}} = V_O = V^+/2$  and  $R_L > 1\text{ M}\Omega$ . **Boldface** limits apply at the temperature extremes.

Symbol	Parameter	Conditions	Typ (Note 5)	LMC6582AI LMC6584AI Limit (Note 6)	LMC6582BI LMC6584BI Limit (Note 6)	Units
$V_{\text{OS}}$	Input Offset Voltage	$V^+ = 1.8\text{V}$ , $V_{\text{CM}} = 1.5\text{V}$	0.5	3	10	mV max
		$V^+ = 2.2\text{V}$ , $V_{\text{CM}} = 1.5\text{V}$	0.5	2 <b>3.8</b>	6 <b>7.8</b>	mV max
$\text{TCV}_{\text{OS}}$	Input Offset Voltage Average Drift	$V^+ = 2.2\text{V}$	1.5			$\mu\text{V}/^\circ\text{C}$
$I_B$	Input Current	$V^+ = 2.2\text{V}$ (Note 12)	0.08	<b>20</b>	<b>20</b>	pA max
$I_{\text{OS}}$	Input Offset Current	$V^+ = 2.2\text{V}$ (Note 12)	0.04	<b>10</b>	<b>10</b>	pA max
CMRR	Common Mode Rejection Ratio	$V^+ = 2.2\text{V}$ , (Note 13)	82	60	60	dB min
		$V^+ = 1.8\text{V}$ , (Note 13)	82	50	50	dB min
PSRR	Power Supply Rejection Ratio	$\pm 1.1\text{V} \leq V_S \leq \pm 5\text{V}$ , $V_O = V^+/2 = V_{\text{CM}}$	82	70 <b>65</b>	65 <b>62</b>	dB min
$V_{\text{CM}}$	Input Common Mode Voltage Range	$V^+ = 2.2\text{V}$ CMRR > 40 dB	2.38 -0.15	2.2 0.0	2.2 0.0	V min V max
		$V^+ = 1.8\text{V}$ CMRR > 40 dB	1.98 -0.10	1.8 0.0	1.8 0.0	V min V max
$V_O$	Output Swing	$V^+ = 2.2\text{V}$ $R_L = 2\text{ k}\Omega$ to $V^+/2$	2.15	2.0 <b>1.88</b>	2.0 <b>1.88</b>	V min
			0.05	0.2 <b>0.32</b>	0.2 <b>0.32</b>	V max
		$V^+ = 1.8\text{V}$ $R_L = 2\text{ k}\Omega$ to $V^+/2$	1.75	1.6 <b>1.44</b>	1.6 <b>1.44</b>	V min
			0.05	0.2 <b>0.36</b>	0.2 <b>0.36</b>	V max
$I_S$	Supply Current	Dual, LMC6582 $V_{\text{CM}} = 1.5\text{V}$	1.4	2.2 <b>2.7</b>	2.2 <b>2.7</b>	mA max
		Quad, LMC6584 $V_{\text{CM}} = 1.5\text{V}$	2.8	4.4 <b>5.3</b>	4.4 <b>5.3</b>	mA max

## 5V DC Electrical Characteristics

Unless otherwise specified, all limits guaranteed for  $T_J = 25^\circ\text{C}$ ,  $V^+ = 5.0\text{V}$ ,  $V^- = 0\text{V}$ ,  $V_{\text{CM}} = V_O = V^+/2$  and  $R_L > 1\text{ M}\Omega$ . **Bold-face** limits apply at the temperature extremes.

Symbol	Parameter	Conditions	Typ (Note 5)	LMC6582AI LMC6584AI Limit (Note 6)	LMC6582BI LMC6584BI Limit (Note 6)	Units
$V_{\text{OS}}$	Input Offset Voltage	$V_{\text{CM}} = 1.5\text{V}$	0.5	1 <b>2.5</b>	3 <b>4.5</b>	mV max
$\text{TCV}_{\text{OS}}$	Input Offset Voltage Average Drift		1.5			$\mu\text{V}/^\circ\text{C}$
$I_B$	Input Current	(Note 12)	0.08	<b>20</b>	<b>20</b>	pA max
$I_{\text{OS}}$	Input Offset Current	(Note 12)	0.04	<b>10</b>	<b>10</b>	pA max
$R_{\text{IN}}$	Input Resistance		$>1$			Tera $\Omega$
$C_{\text{IN}}$	Input Capacitance		3			pF
CMRR	Common Mode Rejection Ratio	(Note 13)	82	70 <b>65</b>	65 <b>62</b>	dB min
PSRR	Power Supply Rejection Ratio	$\pm 1.5\text{V} \leq V_S \leq \pm 2.5\text{V}$ , $V_O = V^+/2 = V_{\text{CM}}$	82	70 <b>65</b>	65 <b>62</b>	dB min
$V_{\text{CM}}$	Input Common Mode Voltage Range	CMRR $> 50\text{ dB}$	5.3	5.18 <b>5.00</b>	5.18 <b>5.00</b>	V min
			-0.3	-0.18 <b>0.00</b>	-0.18 <b>0.00</b>	V max
$V_O$	Output Swing	$R_L = 2\text{ k}\Omega$ to $V^+/2$	4.9	4.85 <b>4.58</b>	4.85 <b>4.58</b>	V min
			0.05	0.2 <b>0.28</b>	0.2 <b>0.28</b>	V max
$I_S$	Supply Current	Dual, LMC6582 $V_{\text{CM}} = 1.5\text{V}$	1.5	2.48 <b>3.00</b>	2.48 <b>3.00</b>	mA max
		Quad, LMC6584 $V_{\text{CM}} = 1.5\text{V}$	3.0	4.96 <b>6.00</b>	4.96 <b>6.00</b>	mA max

## 10V DC Electrical Characteristics

Unless otherwise specified, all limits guaranteed for  $T_J = 25^\circ\text{C}$ ,  $V^+ = 10.0\text{V}$ ,  $V^- = 0\text{V}$ ,  $V_{\text{CM}} = V_O = V^+/2$  and  $R_L > 1\text{ M}\Omega$ . **Boldface** limits apply at the temperature extremes.

Symbol	Parameter	Conditions	Typ (Note 5)	LMC6582AI LMC6584AI Limit (Note 6)	LMC6582BI LMC6584BI Limit (Note 6)	Units	
$V_{\text{OS}}$	Input Offset Voltage	$V_{\text{CM}} = 1.5\text{V}$	0.5	1.5 <b>3.0</b>	3.5 <b>5.0</b>	mV max	
$\text{TCV}_{\text{OS}}$	Input Offset Voltage Average Drift		1.5			$\mu\text{V}/^\circ\text{C}$	
$I_{\text{B}}$	Input Current	(Note 12)	0.08	<b>20</b>	<b>20</b>	pA max	
$I_{\text{OS}}$	Input Offset Current	(Note 12)	0.04	<b>10</b>	<b>10</b>	pA max	
$R_{\text{IN}}$	Input Resistance		>1			Tera $\Omega$	
$C_{\text{IN}}$	Input Capacitance		3			pF	
CMRR	Common Mode Rejection Ratio	(Note 13)	82	65 <b>62</b>	65 <b>62</b>	dB min	
PSRR	Power Supply Rejection Ratio	$\pm 1.1\text{V} \leq V^+ \leq \pm 5\text{V}$ , $V_O = V^+/2 = V_{\text{CM}}$	82	70 <b>65</b>	65 <b>62</b>	dB min	
$V_{\text{CM}}$	Input Common Mode Voltage Range	CMRR > 50 dB	10.30 -0.30	10.18 -0.18 <b>10.00</b> <b>0.00</b>	10.18 -0.18 <b>10.00</b> <b>0.00</b>	V min V max	
$V_O$	Output Swing	$R_L = 2\text{ k}\Omega$ to $V^+/2$	9.93 0.08	9.7 <b>9.58</b> 0.3 <b>0.42</b>	9.7 <b>9.58</b> 0.3 <b>0.42</b>	V min V max	
$A_V$	Large Signal Voltage Gain	$R_L = 2\text{ k}\Omega$ to $V^+/2$ (Note 12)	Sourcing Sinking	89 224	25 25	25 25	V/mV V/mV
$I_{\text{SC}}$	Output Short Circuit Current	Sourcing, $V_O = 0\text{V}$ (Note 14)	65	30 <b>22</b>	30 <b>22</b>	mA min	
		Sinking, $V_O = 10\text{V}$ (Note 14)	70	30 <b>22</b>	30 <b>22</b>	mA min	
$I_{\text{S}}$	Supply Current	Dual, LMC6582 $V_{\text{CM}} = 1.5\text{V}$	1.6	3.0 <b>3.6</b>	3.0 <b>3.6</b>	mA max	
		Quad, LMC6584 $V_{\text{CM}} = 1.5\text{V}$	3.2	6.0 <b>7.2</b>	6.0 <b>7.2</b>	mA max	

## AC Electrical Characteristics

Unless otherwise specified, all limits guaranteed for  $T_J = 25^\circ\text{C}$ ,  $V^+ = 3\text{V}$ ,  $V^- = 0\text{V}$ ,  $V_{\text{CM}} = V_O = V^+/2$  and  $R_L > 1\text{M}\Omega$ . **Bold-face** limits apply at the temperature extremes.

Symbol	Parameter	Conditions	Typ (Note 5)	LMC6582AI LMC6584AI Limit (Note 6)	LMC6582BI LMC6584BI Limit (Note 6)	Units
SR	Slew Rate	(Note 8)	1.2	0.7 <b>0.55</b>	0.7 <b>0.55</b>	V/ $\mu\text{s}$ min
		$V^+ = 10\text{V}$ , (Note 10)	1.2	0.7 <b>0.55</b>	0.7 <b>0.55</b>	
GBW	Gain-Bandwidth Product		1.2			MHz
$\phi_m$	Phase Margin		50			Deg
$G_m$	Gain Margin		12			dB
	Amp-to-Amp Isolation	$V^+ = 10\text{V}$ (Note 9)	130			dB
$e_n$	Input-Referred	$f = 1\text{kHz}$	30			$\frac{nV}{\sqrt{\text{Hz}}}$
	Voltage Noise	$V_{\text{CM}} = 0.5\text{V}$				
$i_n$	Input-Referred	$f = 1\text{kHz}$	0.5			$\frac{fA}{\sqrt{\text{Hz}}}$
	Current Noise					
T.H.D.	Total Harmonic Distortion	$f = 1\text{kHz}$ , $A_V = +1$ $R_L = 10\text{k}\Omega$ , $V_O = 2V_{\text{P-P}}$	0.01			%

**Note 1:** Absolute Maximum Ratings indicate limits beyond which damage to the device may occur. Operating ratings indicate conditions for which the device is intended to be functional, but specific performance is not guaranteed. For guaranteed specifications and the test conditions, see the electrical characteristics.

**Note 2:** Human body model, 1.5 k $\Omega$  in series with 100 pF.

**Note 3:** Applies to both single-supply and split-supply operation. Continuous short circuit operation at elevated ambient temperature can result in exceeding the maximum allowed junction temperature of 150°C. Output current in excess of  $\pm 30\text{mA}$  over long term may adversely affect reliability.

**Note 4:** The maximum power dissipation is a function of  $T_{J(\text{max})}$ ,  $\theta_{\text{JA}}$ , and  $T_A$ . The maximum allowable power dissipation at any ambient temperature is  $P_D = (T_{J(\text{max})} - T_A)/\theta_{\text{JA}}$ . All numbers apply for packages soldered directly into a PC board.

**Note 5:** Typical Values represent the most likely parametric norm.

**Note 6:** All limits are guaranteed by testing or statistical analysis.

**Note 7:**  $V^+ = 3\text{V}$ ,  $V_{\text{CM}} = 0.5\text{V}$ . For sourcing and sinking,  $0.5\text{V} \leq V_O \leq 2.5\text{V}$ .

**Note 8:**  $V^+ = 3\text{V}$ . Connected as Voltage Follower with 2V step input, and output is measured from 0.8V to 2.2V. Number specified is the slower of the positive or negative slew rates.

**Note 9:** Input referred,  $V^+ = 10\text{V}$ , and  $R_L = 100\text{k}\Omega$  connected to 5V. Each amp excited in turn with 1 kHz to produce  $V_O = 2V_{\text{PP}}$ .

**Note 10:**  $V^+ = 10\text{V}$ . Connected as voltage follower with 8V step Input, and output is measured from 2V to 8V. Number specified is the slower of the positive or negative slew rates.

**Note 11:** Limiting input pin current is only necessary for input voltages that exceed absolute maximum input voltage ratings.

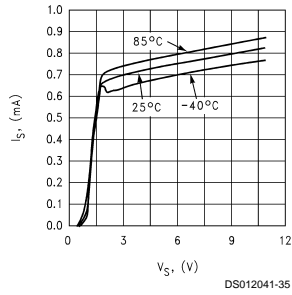
**Note 12:** Guaranteed limits are dictated by tester limitations and not device performance. Actual performance is reflected in the typical value.

**Note 13:** CMRR<sup>+</sup> and CMRR<sup>-</sup> are tested, and the number indicated is the lower of the two values. For CMRR<sup>+</sup>,  $V^+/2 < V_{\text{CM}} < V^+$  for 1.8V, 2.2V, 3V, 5V, and 10V. For CMRR<sup>-</sup>,  $0 < V_{\text{CM}} < V^+/2$  for 3V, 5V and 10V. For 1.8V and 2.2V,  $0.25 < V_{\text{CM}} < V^+ - 0.3$ .

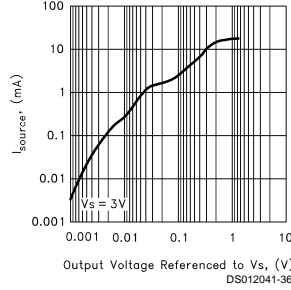
**Note 14:**  $V^+ = 10\text{V}$ ,  $V_{\text{CM}} = 0.5\text{V}$ . For Sourcing tests,  $1\text{V} \leq V_O \leq 5\text{V}$ . For Sinking tests,  $5\text{V} \leq V_O \leq 9\text{V}$ .

**Typical Performance Characteristics**  $V_{S+} = 3V$ , Single Supply,  $T_A = 25^\circ C$  unless otherwise specified.

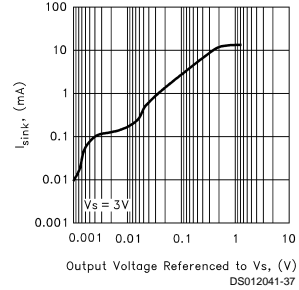
**Supply Current Per Amplifier vs Supply Voltage**



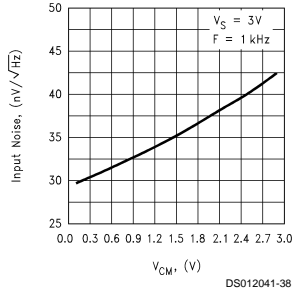
**Sourcing Current vs Output Voltage**



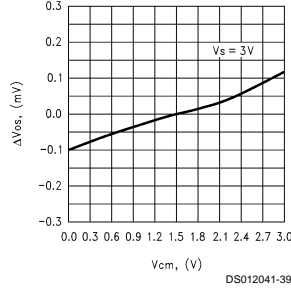
**Sinking Current vs Output Voltage**



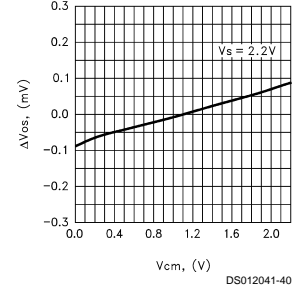
**Input Voltage Noise vs Common-Mode Voltage**



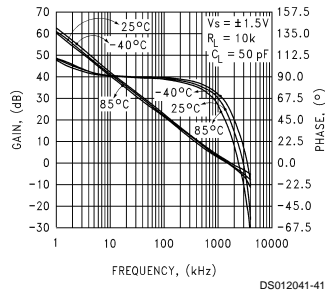
**$\Delta V_{OS}$  vs  $V_{CM}$**



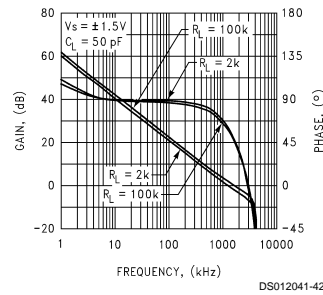
**$\Delta V_{OS}$  vs  $V_{CM}$**



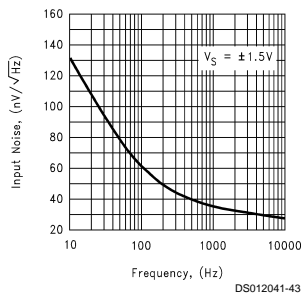
**Frequency Response vs Temperature**



**Frequency Response vs  $R_L$**



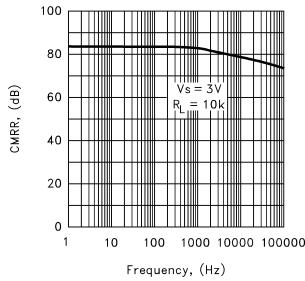
**Input Voltage Noise vs Frequency**





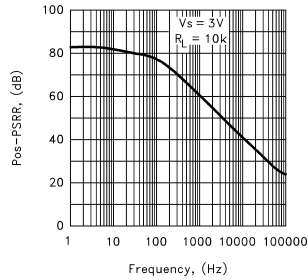
**Typical Performance Characteristics**  $V_{S+} = 3V$ , Single Supply,  $T_A = 25^\circ C$  unless otherwise specified. (Continued)

**CMRR vs Frequency**



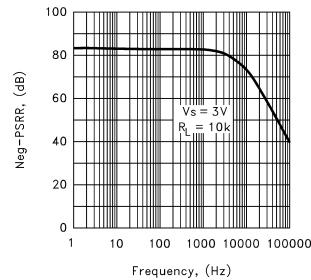
DS012041-44

**Positive PSRR vs Frequency**



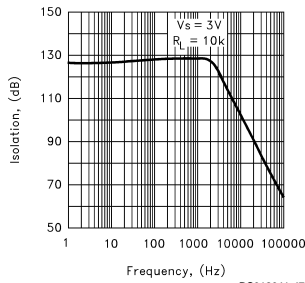
DS012041-45

**Negative PSRR vs Frequency**



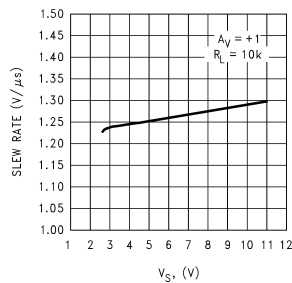
DS012041-46

**Crosstalk Rejection vs Frequency**



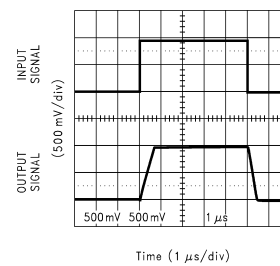
DS012041-47

**Slew Rate vs Supply Voltage**



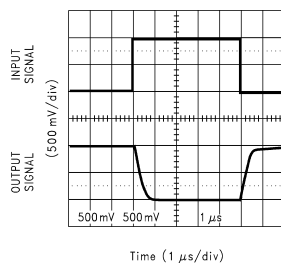
DS012041-48

**Non-Inverting Large Signal Pulse Response**



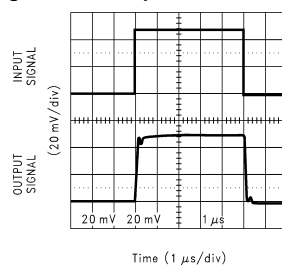
DS012041-49

**Inverting Large Signal Pulse Response**



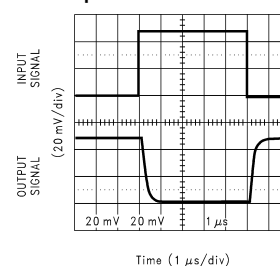
DS012041-50

**Non-Inverting Small Signal Pulse Response**



DS012041-51

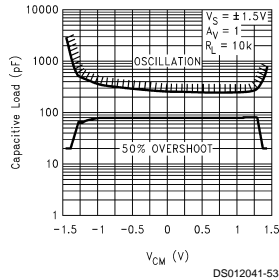
**Inverting Small Signal Pulse Response**



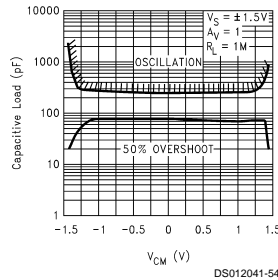
DS012041-52

**Typical Performance Characteristics**  $V_{S+} = 3V$ , Single Supply,  $T_A = 25^\circ C$  unless otherwise specified. (Continued)

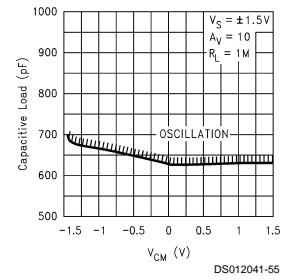
**Stability vs Capacitive Load**



**Stability vs Capacitive Load**



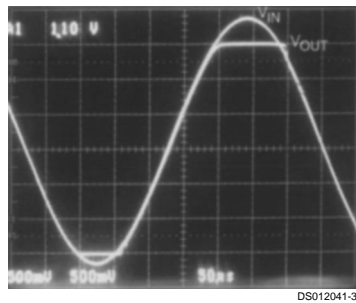
**Stability vs Capacitive Load**



**Application Information**

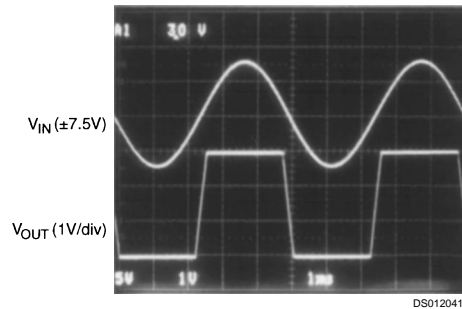
**1.0 Input Common-Mode Voltage Range**

The LMC6582/4 has a rail-to-rail input common-mode voltage range. *Figure 1* shows an input voltage exceeding both supplies with no resulting phase inversion on the output.

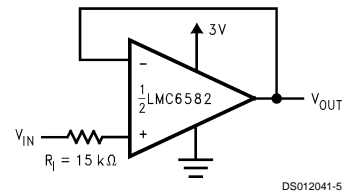


**FIGURE 1. An Input Signal Exceeds the LMC6582 Power Supply Voltages with No Output Phase Inversion**

The absolute maximum input voltage at  $V^+ = 3V$  is 300 mV beyond either supply rail at room temperature. Voltages greatly exceeding this absolute maximum rating, as in *Figure 2*, can cause excessive current to flow in or out of the input pins, possibly affecting reliability. The input current can be externally limited to  $\pm 5$  mA, with an input resistor, as shown in *Figure 3*.



**FIGURE 2. A  $\pm 7.5V$  Input Signal Greatly Exceeds the 3V Supply, Causing No Phase Inversion Due to  $R_I$**



**FIGURE 3. Input Current Protection for Voltages Exceeding the Supply Voltage**

**2.0 Rail-to-Rail Output**

The approximated output resistance of the LMC6582 is  $50\Omega$  sourcing, and  $50\Omega$  sinking at  $V_S = 3V$ . The maximum output swing can be estimated as a function of load using the calculated output resistance.

**3.0 Low Voltage Operation**

The LMC6582/4 operates at supply voltages of 2.2V and 1.8V. These voltages represent the End of Discharge voltages of several popular batteries. The amplifier can operate from 1 Lead-Acid or Lithium Ion battery, or 2NiMH, NiCd, or Carbon-Zinc batteries. Nominal and End of Discharge of Voltage of several batteries are listed below.

### 3.0 Low Voltage Operation (Continued)

Battery Type	Nominal Voltage	End of Discharge Voltage
NiMH	1.2V	1V
NiCd	1.2V	1V
Lead-Acid	2V	1.8V
Silver Oxide	1.6V	1.3V
Carbon-Zinc	1.5V	1.1V
Lithium	2.6V–3.6V	1.7V–2.4V

At  $V_S = 2.2V$ , the LMC6582/4 has a rail-to-rail input common-mode voltage range. Figure 4 shows an input voltage extending to both supplies and the resulting output.

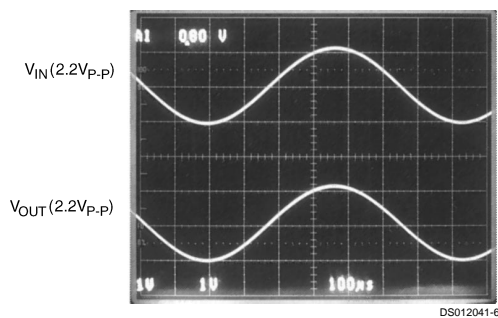


FIGURE 4. The Input Common-Mode Voltage Range Extends to Both Supplies at  $V_S = 2.2V$

The amplifier is operational at  $V_S = 1.8V$ , with guaranteed input common-mode voltage range, output swing, and CMRR specs. Figure 5 shows the response of the LMC6582/4 at  $V_S = 1.8V$ .

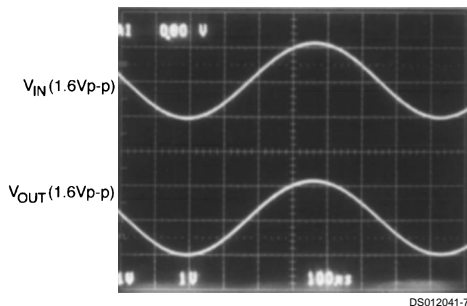


FIGURE 5. Response of the LMC6582/4 at  $V_S = 1.8V$

Figure 6 shows an input voltage exceeding both supplies with no resulting phase inversion on the output.

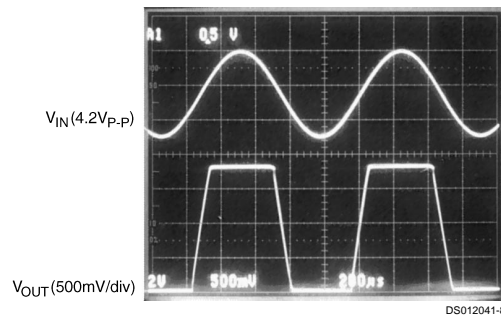


FIGURE 6. An Input Voltage Signal Exceeds LMC6582/4 Power Supply Voltages of  $V_S = 1.8V$  with No Output Phase Inversion

### 4.0 Capacitive Load Tolerance

The LMC6582/4 can typically drive a 100 pF load with  $V_S = 10V$  at unity gain without oscillating. The unity gain follower is the most sensitive configuration to capacitive load. Direct capacitive loading reduces the phase margin of op-amps. The combination of the op-amp's output impedance and the capacitive load induces phase lag. This results in either an underdamped pulse response or oscillation.

Capacitive load compensation can be accomplished using resistive isolation as shown in Figure 7. If there is a resistive component of the load in parallel to the capacitive component, the isolation resistor and the resistive load create a voltage divider at the output. This introduces a DC error at the output.

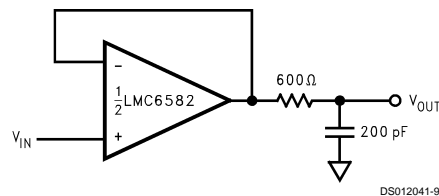


FIGURE 7. Resistive Isolation of a 350 pF Capacitive Load

Figure 8 displays the pulse response of the LMC6582 circuit in Figure 7.

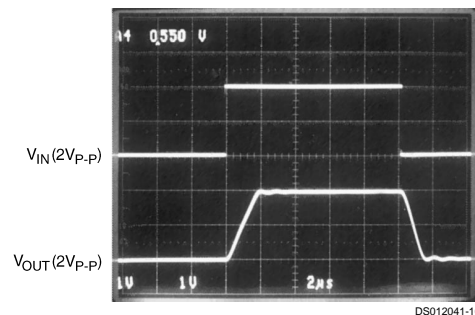
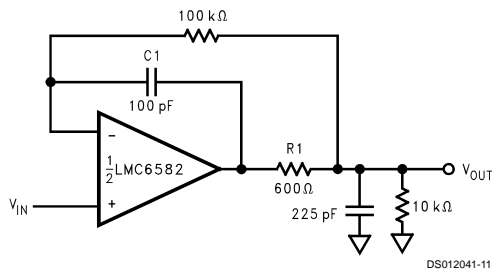


FIGURE 8. Pulse Response of the LMC6582 Circuit in Figure 7

## 4.0 Capacitive Load Tolerance

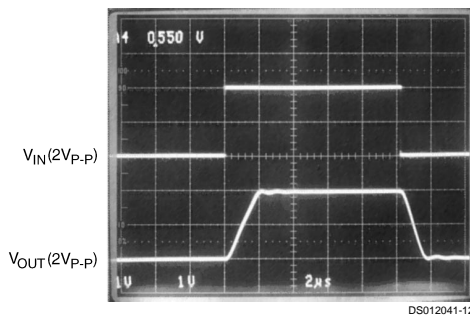
(Continued)

Another circuit, shown in *Figure 9*, is also used to indirectly drive capacitive loads. This circuit is an improvement to the circuit shown *Figure 7* because it provides DC accuracy as well as AC stability. R1 and C1 serve to counteract the loss of phase margin by feeding the high frequency component of the output signal back to the amplifiers inverting input, thereby preserving phase margin in the overall feedback loop. The values of R1 and C1 should be experimentally determined by the system designer for the desired pulse response. Increased capacitive drive is possible by increasing the value of the capacitor in the feedback loop.



**FIGURE 9. The LMC6582 Compensated to Ensure DC Accuracy and AC Stability**

The pulse response of the circuit shown in *Figure 9* is shown in *Figure 10*.



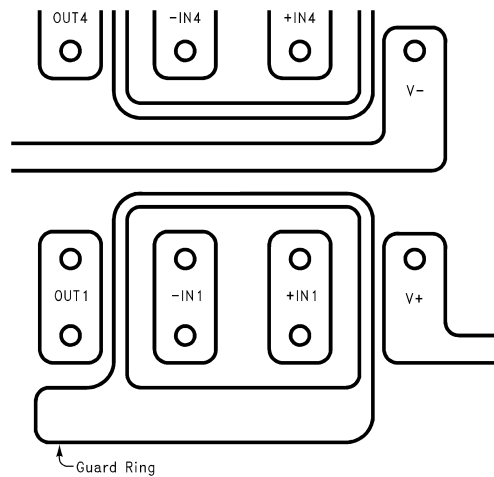
**FIGURE 10. Pulse Response of the LMC6582 Circuit Shown in Figure 9**

## 5.0 Printed-Circuit-Board Layout for High-Impedance Work

It is generally recognized that any circuit which must operate with less than 1000 pA of leakage current requires special layout of the PC board. When one wishes to take advantage of the ultra-low input current of the LMC6582/4, typically 80 fA, it is essential to have an excellent layout. Fortunately, the techniques of obtaining low leakages are quite simple. First, the user must not ignore the surface leakage of the PC board, even though it may sometimes appear acceptably low, because under conditions of high humidity or dust or contamination, the surface leakage will be appreciable.

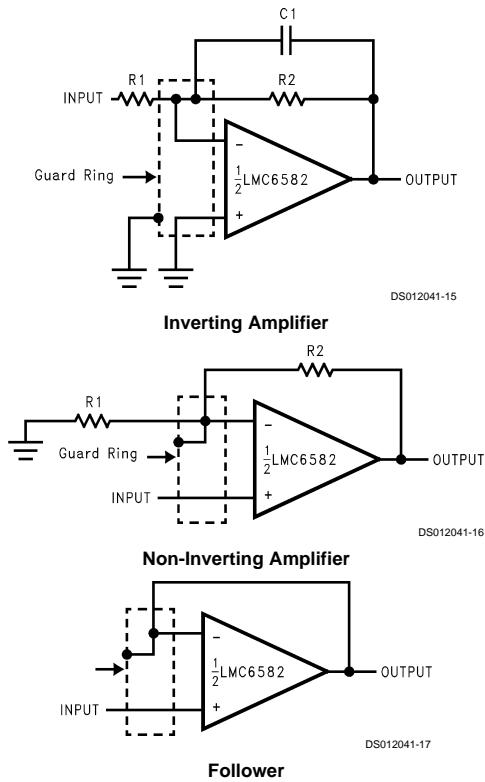
To minimize the effect of any surface leakage, lay out a ring of foil completely surrounding the LMC6582/4's inputs and the terminals of capacitors, diodes, conductors, resistors, re-

lay terminals, etc. connected to the op-amp's inputs, as in *Figure 11*. To have a significant effect, guard rings should be placed in both the top and bottom of the PC board. This PC foil must then be connected to a voltage which is at the same voltage as the amplifier inputs, since no leakage current can flow between two points at the same potential. For example, a PC board trace-to-pad resistance of  $10^{12}\Omega$ , which is normally considered a very large resistance, could leak 5 pA if the trace were a 5V bus adjacent to the pad of the input. This would cause a 60 times degradation from the LMC6582/4's actual performance. However, if a guard ring is held within 5 mV of the inputs, then even a resistance of  $10^{11}\Omega$  would cause only 0.05 pA of leakage current. See *Figure 12* for typical connections of guard rings for standard op-amp configurations.



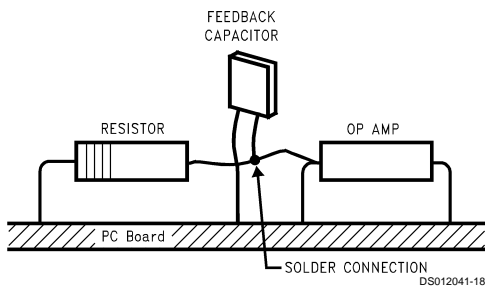
**FIGURE 11. Example of Guard Ring in PC Board Layout**

## 5.0 Printed-Circuit-Board Layout for High-Impedance Work (Continued)



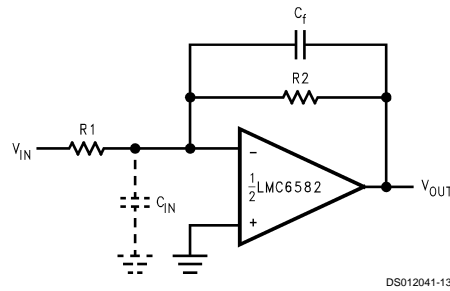
**FIGURE 12. Typical Connections of Guard Rings**

The designer should be aware that when it is inappropriate to lay out a PC board for the sake of just a few circuits, there is another technique which is even better than a guard ring on a PC board: Don't insert the amplifier's input pin into the board at all, but bend it up in the air and use only air as an insulator. Air is an excellent insulator. In this case you may have to forego some of the advantages of PC board construction, but the advantages are sometimes well worth the effort of using point-to-point up-in-the-air wiring. See *Figure 13*.



## 6.0 Compensating for Input Capacitance

It is quite common to use large values of feedback resistance with amplifiers that have ultra-low input current, like the LMC6582/4. Large feedback resistors can react with small values of input capacitance due to transducers, photodiodes, and circuits board parasitics to reduce phase margins.



**FIGURE 14. Canceling the Effect of Input Capacitance**

The effect of input capacitance can be compensated for by adding a feedback capacitor. The feedback capacitor (as in *Figure 14*),  $C_F$ , is first estimated by:

$$\frac{1}{2\pi R_1 C_{IN}} \geq \frac{1}{2\pi R_2 C_F}$$

or

$$R_1 C_{IN} \leq R_2 C_F$$

which typically provides significant overcompensation.

Printed circuit board stray capacitance may be larger or smaller than that of a breadboard, so the actual optimum value for  $C_F$  may be different. The values of  $C_F$  should be checked on the actual circuit. (Refer to the LMC660 quad CMOS amplifier data sheet for a more detailed discussion.)

## 7.0 Spice Macromodel

A Spice Macromodel is available for the LMC6582/4. The model includes a simulation of:

- Input common-mode voltage range
- Frequency and transient response
- GBW dependence on loading conditions
- Quiescent and dynamic supply current
- Output swing dependence on loading conditions

and many more characteristics as listed on the macromodel disk.

Contact the National Semiconductor Customer Response Center at 1-800-272-9959 to obtain an operational amplifier spice model library disk.

## Applications

### Transducer Interface Circuits

#### A. PIEZOELECTRIC TRANSDUCERS

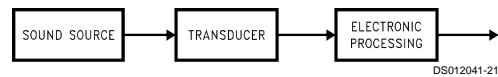


FIGURE 15. Transducer Interface Application

The LMC6582/4 can be used for processing of transducer signals as shown in the circuit below. The two 11 MΩ resistors provide a path for the DC currents to ground. Since the resistors are boot-strapped to the output, the AC input resistance of the LMC6582/4 is much higher.

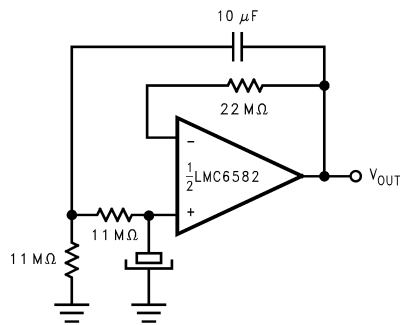


FIGURE 16. LMC6582 Used for Signal Processing

An input current of 80 fA and a CMRR of 82 dB causes an insignificant error offset voltage at the output. The rail-to-rail performance of the amplifier also provides the maximum dynamic range for the transducer signals.

#### B. PHOTODIODE AMPLIFIERS

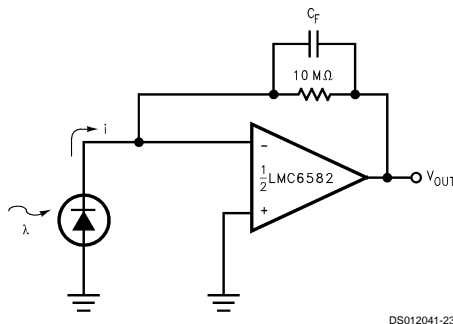


FIGURE 17. Photodiode Amplifier

Photocells can be used in light measuring instruments. An error voltage is produced at the output due to the input current and the offset voltage of the amplifier. The LMC6582/4 which can be operated off a single battery is an excellent choice for this application because of its 80 fA input current and 0.5 mV offset voltage.

### Low Voltage Peak Detector

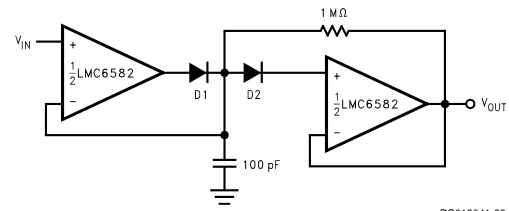


FIGURE 18. Low Voltage Peak Detector

The accuracy of the peak detector is dependent on the leakage currents of the diodes and the capacitor, and the non-idealities of the amplifier. The parameters of the amplifier which can limit the performance of this circuit are (a) Finite slew rate (b) Input current, and (c) Maximum output current of the amplifier.

The input current of the amplifier causes a slow discharge of the capacitor. This phenomenon is called "drooping". The LMC6582/4 has a typical input current of 80 fA. This would cause the capacitor to droop at a rate of  $dv/dt = I_B/C = 80 \text{ fA}/100 \text{ pF} = 0.8 \text{ mV/s}$ . Accuracy in the amplitude measurement is also maintained by an offset voltage of 0.5 mV, and an open-loop gain of 120 dB.

### Oscillators

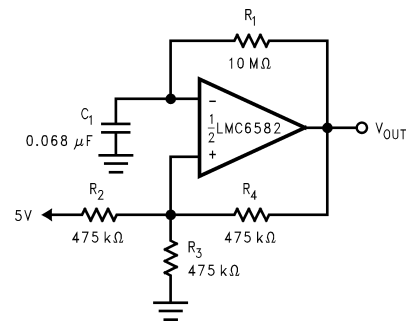


FIGURE 19. 1 Hz Square-Wave Oscillator

For single supply 5V operation, the output of the circuit will swing 0V to 5V. The voltage divider set by the resistors will cause the input at the non-inverting terminal of the op-amp to move  $1/3$  (1.67V) of the supply voltage to  $2/3$  (3.33V) of the supply voltage. This voltage behaves as the threshold voltage, and causes the capacitor to alternately charge and discharge.

R1 and C1 determine the time constant for the circuit. The frequency of oscillation,  $f_{OSC}$  is

$$\left( \frac{1}{2 \Delta t} \right)$$

where  $\Delta t$  is the time the amplifier input takes to move from 1.67V to 3.33V. The calculations are shown below.

$$1.67 = 5 \left( 1 - e^{-\frac{t_1}{\tau}} \right)$$

where  $\tau = RC = 0.68$  seconds

## Oscillators (Continued)

→  $t_1 = 0.27$  seconds  
and

$$3.33 = 5 \left( 1 - e^{-\frac{t_1}{\tau}} \right)$$

→  $t_2 = 0.74$  seconds  
Then,

$$f_{osc} = \left( \frac{1}{2\Delta t} \right)$$

$$= \frac{1}{2(0.74 - 0.27)}$$

~ 1 Hz

## LMC6582/4 as a Comparator

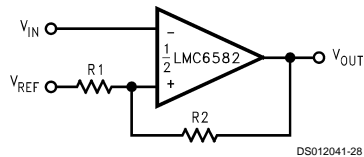


FIGURE 20. Comparator with Hysteresis

Figure 20 shows the application of the LMC6582/4 as a comparator. The hysteresis is determined by the ratio of the two resistors. Since the supply current of the LMC6582/4 is less than 1 mA per amplifier, it can be used as a low power comparator, in applications where the quiescent current is an important parameter.

Typical propagation delays @  $V_S = 3V$  would be on the order of  $t_{PHL} = 6 \mu s$ , and  $t_{PLH} = 5 \mu s$ .

## Filters

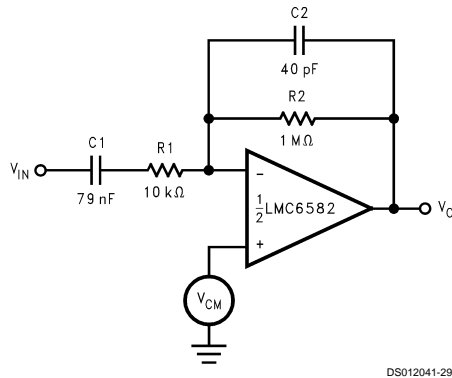


FIGURE 21. Wide-Band Band-Pass Filter

The filter shown in Figure 21 is used to process "voice-band" signals. The bandpass filter has a flatband gain of 40 dB. The two corner frequencies,  $f_1$  and  $f_2$ , are calculated as:

$$f_1 = \frac{1}{2\pi R_1 C_1} = \frac{1}{2\pi(10 \text{ k}\Omega)(79 \text{ nF})} = 200 \text{ Hz}$$

$$f_2 = \frac{1}{2\pi R_2 C_2} = \frac{1}{2\pi(1 \text{ M}\Omega)(40 \text{ pF})} = 4 \text{ kHz}$$

The LMC6582/4, with its rail-to-rail input common mode voltage range and high gain (120 dB typical,  $R_L = 10 \text{ k}\Omega$ ) is extremely well suited for such filter applications. The rail-to-rail input range allows for large input signals to be processed without distortion. The high gain means that the circuit can provide filtering and gain in one stage, instead of the typical two stage filter. This implies a reduction in cost, and a savings of space and power.

This is an illustration of a conceptual use of the LMC6582/4. The selectivity of the filter can be improved by increasing the order (number of poles) of the design.

## Sample-and-Hold Circuits

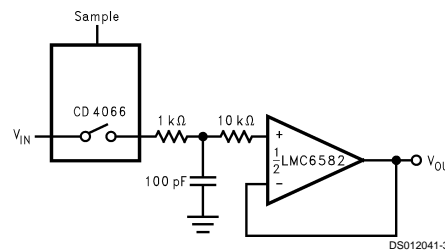


FIGURE 22. Sample-and-Hold Application

When the "switch" is closed during the sample interval,  $C_{HOLD}$  charges up to the value of the input signal. When the "switch" is open,  $C_{HOLD}$  retains this value as it is buffered by the high input impedance of the LMC6582/4.

Errors in the "hold" voltage are caused by the input current of the amplifier, the leakage current of the CD4066, and the leakage current of the capacitor. While an input current of 80 fA minimizes the accumulation rate for error in the circuit, the LMC6582/4's CMRR of 82 dB allows excellent accuracy throughout the amplifier's rail-to-rail dynamic capture range.

## Battery Monitoring Circuit

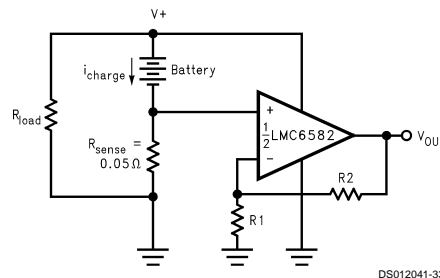
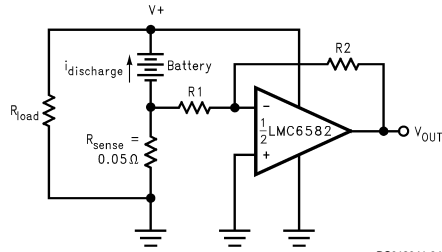


FIGURE 23. Circuit Used to Sense Charging.

## Battery Monitoring Circuit (Continued)



DS012041-34

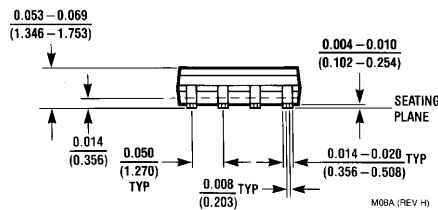
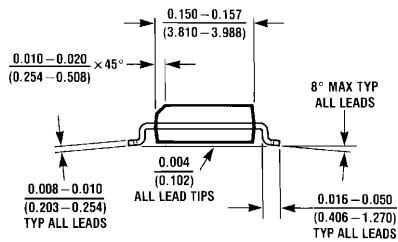
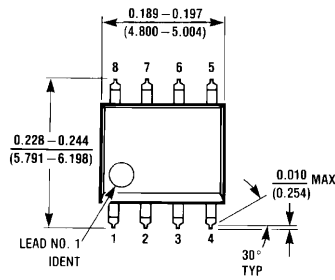
FIGURE 24. Circuit used to Sense Discharging

The LMC6582/4 has been optimized for performance at 3V, and also has guaranteed specs at 1.8V and 2.2V. In portable applications, the  $R_{Load}$  represents the laptop/notebook, or any other computer which the battery is powering. A desired output voltage can be achieved by manipulating the ratios of the feedback resistors. During the charging cycle, the current flows out of the battery as shown. While during discharge, the current is in the reverse direction. Since the current can range from a few milliamperes to amperes, the amplifier will have to sense a signal below ground during the discharge cycle. At 3V, the LMC6582/4 can accept a signal up to 300 mV below ground. The common-mode voltage range of the LMC6582/4, which extends beyond both rails is thus a very useful feature in this application.

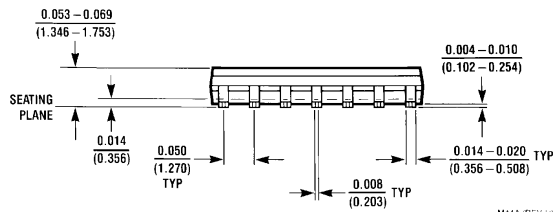
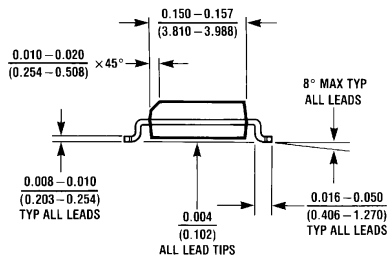
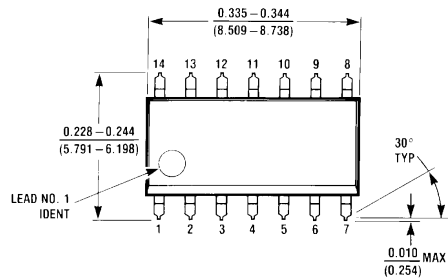
A typical offset voltage of 0.5 mV, and CMRR of 82 dB maintain accuracy in the circuit outputs while the rail-to-rail output performance allows for a maximum signal range.



**Physical Dimensions** inches (millimeters) unless otherwise noted

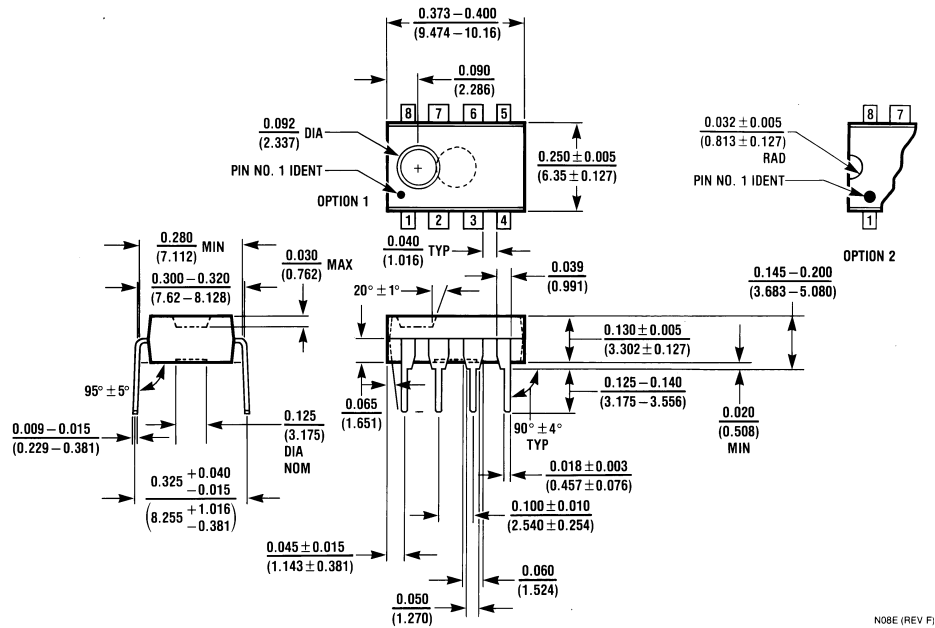


**8-Pin Small Outline Package**  
Order Number LMC6582AIM or LMC6582BIM  
NS Package Number M08A

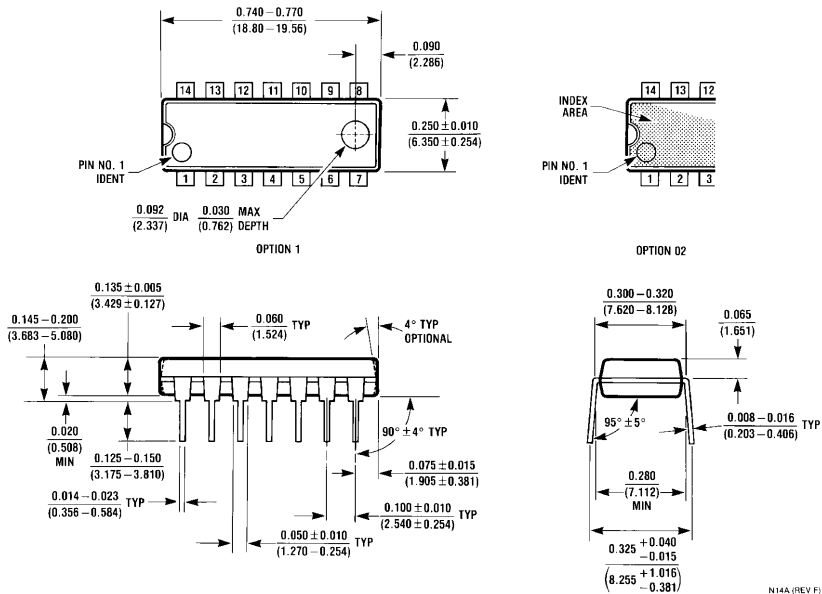


**14-Pin Small Outline Package**  
Order Number LMC6584AIM or LMC6584BIM  
NS Package Number M14A

**Physical Dimensions** inches (millimeters) unless otherwise noted (Continued)



**8-Pin Molded Dual-In-Line Package**  
 Order Number LMC6582AIN or LMC6582BIN  
 NS Package Number N08E



**14-Pin Molded Dual-In Line Package**  
 Order Number LMC6584AIN or LMC6584BIN  
 NS Package Number N14A

## Notes

### LIFE SUPPORT POLICY

NATIONAL'S PRODUCTS ARE NOT AUTHORIZED FOR USE AS CRITICAL COMPONENTS IN LIFE SUPPORT DEVICES OR SYSTEMS WITHOUT THE EXPRESS WRITTEN APPROVAL OF THE PRESIDENT OF NATIONAL SEMICONDUCTOR CORPORATION. As used herein:

1. Life support devices or systems are devices or systems which, (a) are intended for surgical implant into the body, or (b) support or sustain life, and whose failure to perform when properly used in accordance with instructions for use provided in the labeling, can be reasonably expected to result in a significant injury to the user.
2. A critical component is any component of a life support device or system whose failure to perform can be reasonably expected to cause the failure of the life support device or system, or to affect its safety or effectiveness.



**National Semiconductor Corporation**  
Americas  
Tel: 1-800-272-9959  
Fax: 1-800-737-7018  
Email: support@nsc.com

[www.national.com](http://www.national.com)

**National Semiconductor Europe**  
Fax: +49 (0) 1 80-530 85 86  
Email: europe.support@nsc.com  
Deutsch Tel: +49 (0) 1 80-530 85 85  
English Tel: +49 (0) 1 80-532 78 32  
Français Tel: +49 (0) 1 80-532 93 58  
Italiano Tel: +49 (0) 1 80-534 16 80

**National Semiconductor Asia Pacific Customer Response Group**  
Tel: 65-2544466  
Fax: 65-2504466  
Email: sea.support@nsc.com

**National Semiconductor Japan Ltd.**  
Tel: 81-3-5639-7560  
Fax: 81-3-5639-7507