

## LM112/LM212/LM312 Operational Amplifiers

### General Description

The LM112 series are micropower operational amplifiers with very low offset-voltage and input-current errors—at least a factor of ten better than FET amplifiers over a  $-55^{\circ}\text{C}$  to  $+125^{\circ}\text{C}$  temperature range. Similar to the LM108 series, that also use supergain transistors, they differ in that they include internal frequency compensation and have provisions for offset adjustment with a single potentiometer.

These amplifiers will operate on supply voltages of  $\pm 2\text{V}$  to  $\pm 20\text{V}$ , drawing a quiescent current of only  $300\ \mu\text{A}$ . Performance is not appreciably affected over this range of voltages, so operation from unregulated power sources is easily accomplished. They can also be run from a single supply like the 5V used for digital circuits.

The LM112 series are the first IC amplifiers to improve reliability by including overvoltage protection for the MOS compensation capacitor. Without this feature, IC's have been

known to suffer catastrophic failure caused by short-duration overvoltage spikes on the supplies. Unlike other internally-compensated IC amplifiers, it is possible to overcompensate with an external capacitor to increase stability margin.

The LM212 is identical to the LM112, except that the LM212 has its performance guaranteed over a  $-25^{\circ}\text{C}$  to  $+85^{\circ}\text{C}$  temperature range instead of  $-55^{\circ}\text{C}$  to  $+125^{\circ}\text{C}$ . The LM312 is guaranteed over a  $0^{\circ}\text{C}$  to  $+70^{\circ}\text{C}$  temperature range.

### Features

- Maximum input bias current of 3 nA over temperature
- Offset current less than 400 pA over temperature
- Low noise
- Guaranteed drift specifications

### Connection Diagram

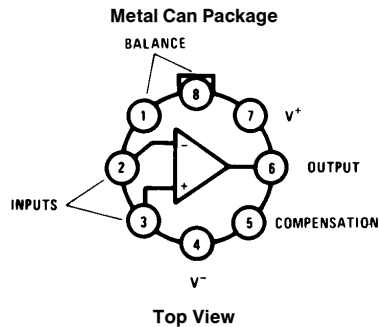

Order Number LM112H, LM212H, LM312H or LM112H/883  
See NS Package Number H08C

### Auxiliary Circuits

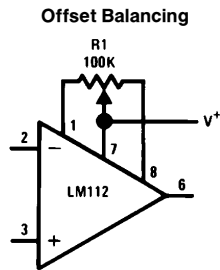

### Overcompensation for Greater Stability Margin

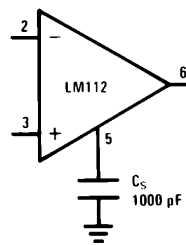

## Absolute Maximum Ratings

If Military/Aerospace specified devices are required, please contact the National Semiconductor Sales Office/Distributors for availability and specifications.  
(Note 5)

	LM112/LM212	LM312
Supply Voltage	±20V	±18V
Power Dissipation (Note 1)	500 mW	500 mW
Differential Input Current (Note 2)	±10 mA	±10 mA
Input Voltage (Note 3)	±15V	±15V
Output Short-Circuit Duration	Continuous	Continuous
Operating Temperature Range		
LM112	−55°C to +125°C	0°C to +70°C
LM212	−25°C to +85°C	
Storage Temperature Range	−65°C to +150°C	−65°C to +150°C
Lead Temperature (Soldering, 10 sec.)	300°C	300°C
ESD rating to be determined.		

## Electrical Characteristics (Note 4)

Parameter	Conditions	LM112/LM212			LM312			Units
		Min	Typ	Max	Min	Typ	Max	
Input Offset Voltage	$T_A = 25^\circ\text{C}$		0.7	2.0		2.0	7.5	mV
Input Offset Current	$T_A = 25^\circ\text{C}$		0.05	0.2		0.2	1	nA
Input Bias Current	$T_A = 25^\circ\text{C}$		0.8	2.0		1.5	7	nA
Input Resistance	$T_A = 25^\circ\text{C}$	30	70		10	40		MΩ
Supply Current	$T_A = 25^\circ\text{C}$		0.3	0.6		0.3	0.8	mA
Large Signal Voltage Gain	$T_A = 25^\circ\text{C}$ , $V_S = \pm 15\text{V}$ $V_{OUT} = \pm 10\text{V}$ , $R_L \geq 10\text{ k}\Omega$	50	300		25	300		V/mV
Input Offset Voltage				3.0			10	mV
Average Temperature Coefficient of Input Offset Voltage			3.0	15		6.0	30	$\mu\text{V}/^\circ\text{C}$
Input Offset Current				0.4			1.5	nA
Average Temperature Coefficient of Input Offset Current			0.5	2.5		2.0	10	pA/ $^\circ\text{C}$
Input Bias Current				3.0			10	nA
Supply Current	$T_A = 125^\circ\text{C}$		0.15	0.4				mA
Large Signal Voltage Gain	$V_S = \pm 15\text{V}$ , $V_{OUT} = \pm 10\text{V}$ $R_L \geq 10\text{ k}\Omega$	25			15			V/mV
Output Voltage Swing	$V_S = \pm 15\text{V}$ , $R_L = 10\text{ k}\Omega$	±13	±14		±13	±14		V
Input Voltage Range	$V_S = \pm 15\text{V}$	±13.5			±14			V
Common-Mode Rejection Ratio		85	100		80	100		dB
Supply Voltage Rejection Ratio		80	96		80	96		dB

**Note 1:** The maximum junction temperature of the LM112 is 150°C, LM212 is 100°C and LM312 is 85°C. For operating at elevated temperatures, devices in the H08 package must be derated based on a thermal resistance of 160°C/W, junction to ambient, or 20°C/W, junction to case.

**Note 2:** The inputs are shunted with shunt diodes for overvoltage protection. Therefore, excessive current will flow if a differential input voltage in excess of 1V is applied between the inputs unless some limiting resistance is used.

**Note 3:** For supply voltages less than ±15V, the absolute maximum input voltage is equal to the supply voltage.

**Note 4:** These specifications apply for  $\pm 5\text{V} \leq V_S \leq \pm 20\text{V}$  and  $-55^\circ\text{C} \leq T_A \leq +125^\circ\text{C}$  (LM112),  $-25^\circ\text{C} \leq T_A \leq +85^\circ\text{C}$  (LM212),  $\pm 5\text{V} \leq V_S \leq \pm 15\text{V}$  and  $0^\circ\text{C} \leq T_A \leq +70^\circ\text{C}$  (LM312) unless otherwise noted.

**Note 5:** Refer to RETS112X for LM112H military specifications.

# Typical Performance Characteristics LM112/LM212

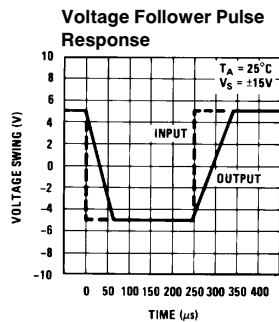
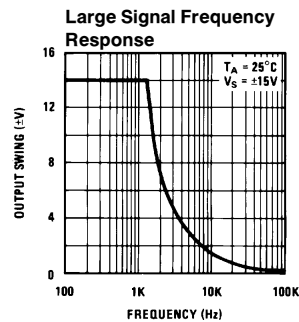
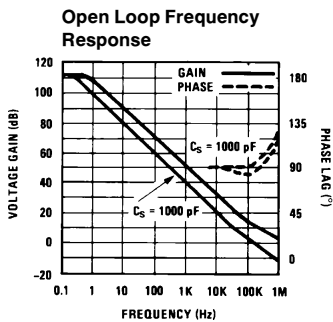
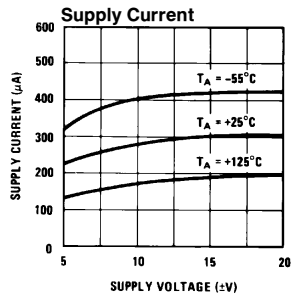
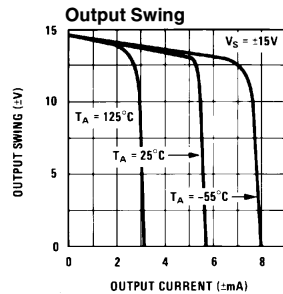
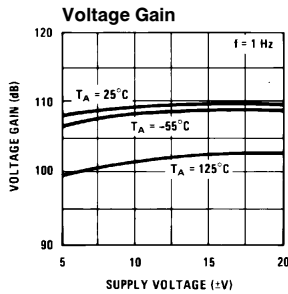
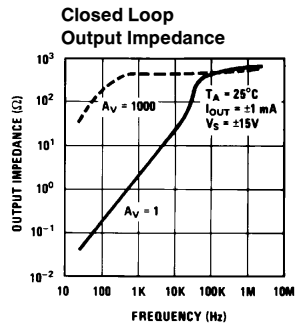
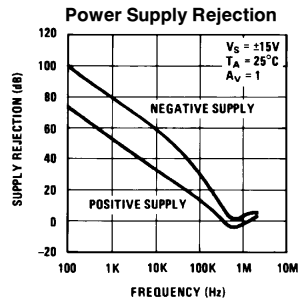
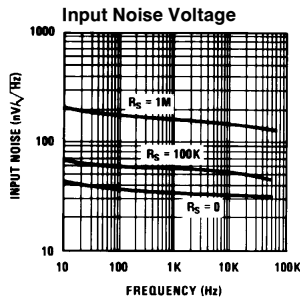
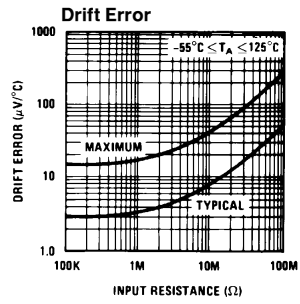
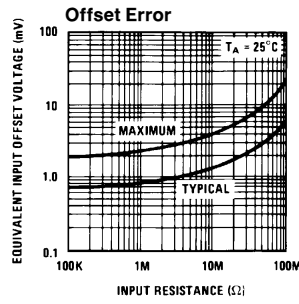
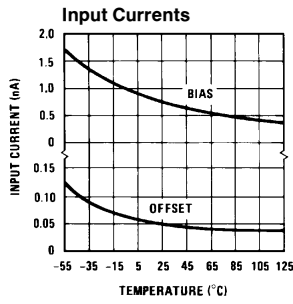

TL/H/7751-5

# Typical Performance Characteristics LM312

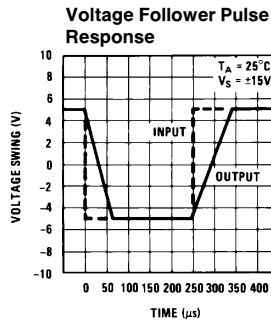
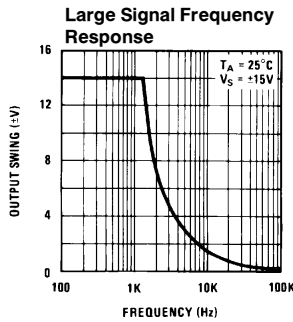
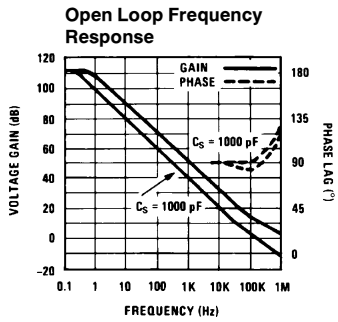
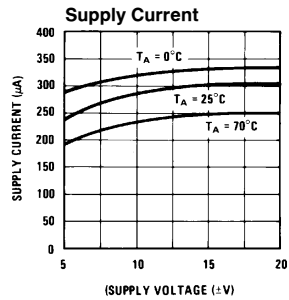
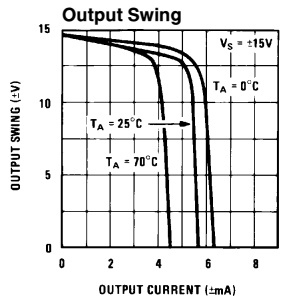
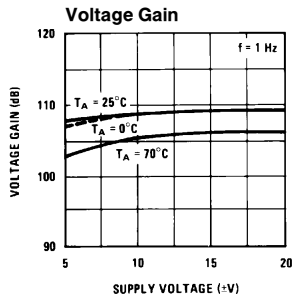
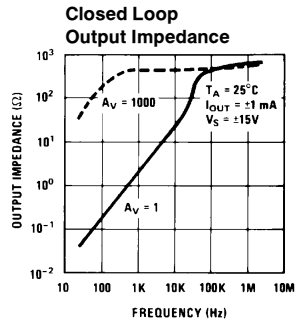
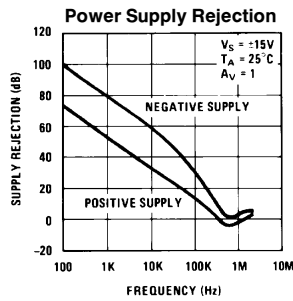
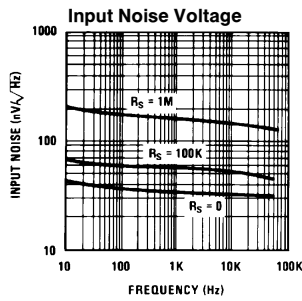
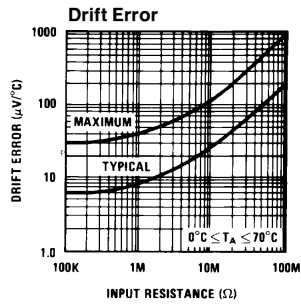
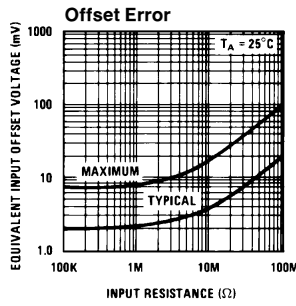
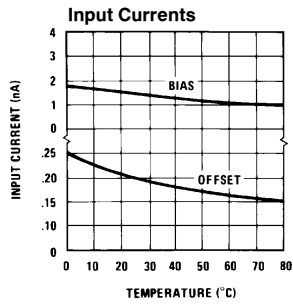

TL/H/7751-6

# Schematic Diagram

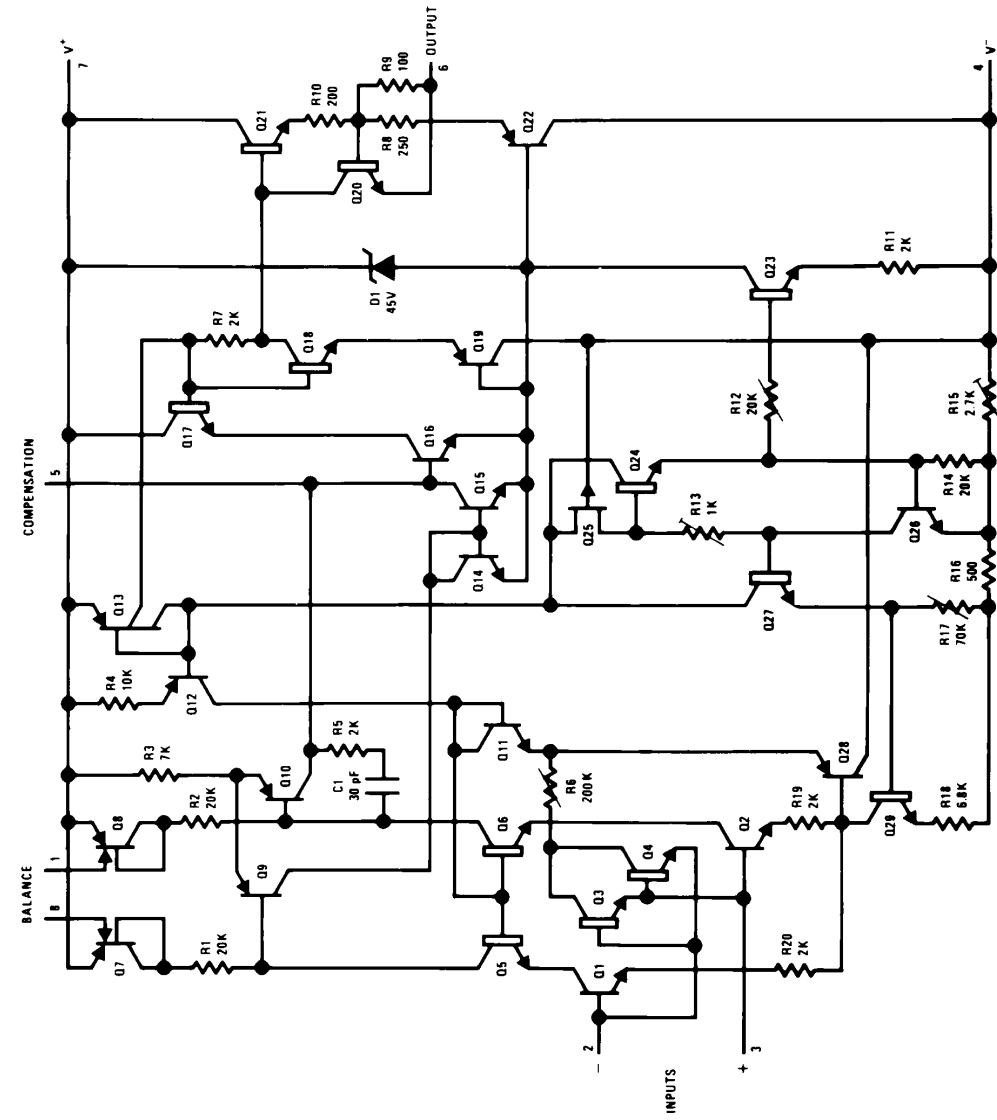

TL/H/7751-1

**Physical Dimensions** inches (millimeters)

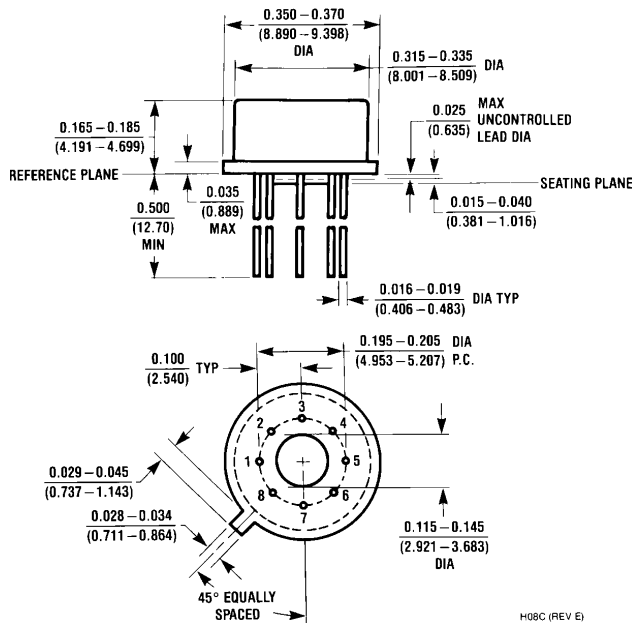

**Metal Can Package (H)**  
**Order Number LM112H, LM212H, LM312H or LM112H/883**  
**NS Package Number H08C**

**LIFE SUPPORT POLICY**

NATIONAL'S PRODUCTS ARE NOT AUTHORIZED FOR USE AS CRITICAL COMPONENTS IN LIFE SUPPORT DEVICES OR SYSTEMS WITHOUT THE EXPRESS WRITTEN APPROVAL OF THE PRESIDENT OF NATIONAL SEMICONDUCTOR CORPORATION. As used herein:

1. Life support devices or systems are devices or systems which, (a) are intended for surgical implant into the body, or (b) support or sustain life, and whose failure to perform, when properly used in accordance with instructions for use provided in the labeling, can be reasonably expected to result in a significant injury to the user.
2. A critical component is any component of a life support device or system whose failure to perform can be reasonably expected to cause the failure of the life support device or system, or to affect its safety or effectiveness.



**National Semiconductor Corporation**  
 1111 West Bardin Road  
 Arlington, TX 76017  
 Tel: 1(800) 272-9959  
 Fax: 1(800) 737-7018

**National Semiconductor Europe**  
 Fax: (+49) 0-180-530 85 86  
 Email: cnjwge@tevm2.nsc.com  
 Deutsch Tel: (+49) 0-180-530 85 85  
 English Tel: (+49) 0-180-532 78 32  
 Français Tel: (+49) 0-180-532 93 58  
 Italiano Tel: (+49) 0-180-534 16 80

**National Semiconductor Hong Kong Ltd.**  
 19th Floor, Straight Block,  
 Ocean Centre, 5 Canton Rd.  
 Tsimshatsui, Kowloon  
 Hong Kong  
 Tel: (852) 2737-1600  
 Fax: (852) 2736-9960

**National Semiconductor Japan Ltd.**  
 Tel: 81-043-299-2309  
 Fax: 81-043-299-2408

National does not assume any responsibility for use of any circuitry described, no circuit patent licenses are implied and National reserves the right at any time without notice to change said circuitry and specifications.