

Single BiCMOS rail-to-rail micropower comparator**Features**

- Rail-to-rail inputs
- Open drain output
- Supply operation from 2.7 to 10 V
- Typical supply current: 6 μ A at 5 V
- Response time of 0.5 μ s at 5 V
- Low input current
- ESD protection: 2 kV (HBM), 200 V (MM)
- Available in tiny SOT23-5 package

Applications

- Battery-powered systems
- Notebooks and PDAs
- PCMCIA cards
- Cellular and mobile communications
- Alarms and security systems
- Replacement of amplifiers used in comparator configurations for improved performance.

Description

The TS7221 is a micropower comparator featuring a rail-to-rail input performance in a tiny SOT23-5 package. This comparator is ideally suited to space and weight-critical applications. It is fully specified at 2.7-, 5- and 10-V operation over industrial temperature ranges (-40°C to +85°C).

The TS7221 features an open-drain output stage. The speed-to-power ratio makes this device ultra-versatile for a wide range of applications.

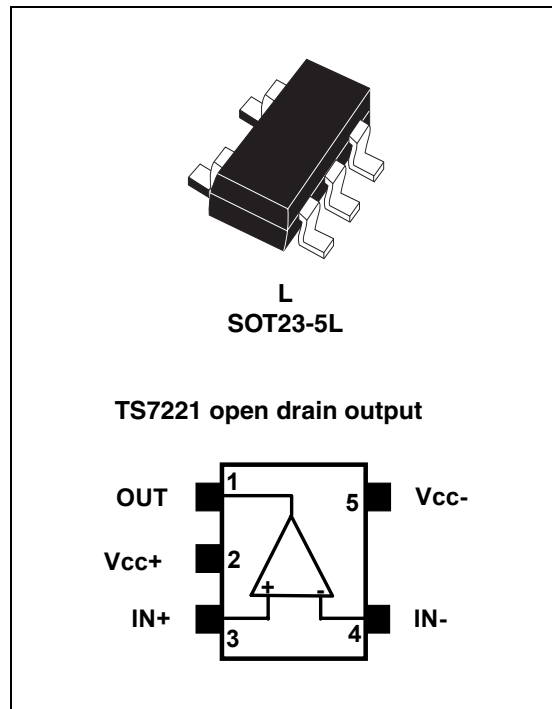

1 Absolute maximum ratings

Table 1. Absolute maximum ratings

| Symbol | Parameter | Value | Unit |
|-------------------|--|--|------|
| V _{CC} | Supply voltage | 12 | V |
| V _{ID} | Differential input voltage | (V _{CC} ⁻) -0.3 to (V _{CC} ⁺) +0.3 | V |
| V _{IN} | Input voltage ⁽¹⁾ | (V _{CC} ⁻) -0.3 to (V _{CC} ⁺) +0.3 | V |
| V _{OUT} | Output voltage | 12 | V |
| I _{IN} | Current at input pins ⁽¹⁾ | ± 5 | mA |
| I _{OUT} | Current at output pin | ± 30 | mA |
| R _{thja} | Thermal resistance junction to ambient ⁽²⁾ SOT23-5 | 250 | °C/W |
| R _{thjc} | Thermal resistance junction to case ⁽²⁾ SOT23-5 | 81 | °C/W |
| T _{Lead} | Lead temperature (soldering 10 seconds) | 260 | °C |
| T _{stg} | Storage temperature | -65 to +150 | °C |
| T _J | Junction temperature | 150 | °C |
| ESD | Human body model (HBM) ⁽³⁾ | 2000 | V |
| | Machine model (MM) ⁽⁴⁾ | 200 | |

1. The magnitude of input voltages must never exceed 0.3 V beyond the supply voltage.
2. Short-circuits can cause excessive heating. These values are typical.
3. Human body model: a 100 pF capacitor is charged to the specified voltage, then discharged through a 1.5 kΩ resistor between two pins of the device. This is done for all couples of connected pin combinations while the other pins are floating.
4. Machine model: a 200 pF capacitor is charged to the specified voltage, then discharged directly between two pins of the device with no external series resistor (internal resistor < 5 Ω). This is done for all couples of connected pin combinations while the other pins are floating.

Table 2. Operating conditions

| Symbol | Parameter | Value | Unit |
|------------------|---------------------------------|--|------|
| V _{CC} | Supply voltage | 2.7 to 10 | V |
| T _{amb} | Ambient temperature | -40 to +85 | °C |
| V _{icm} | Common mode input voltage range | (V _{CC} ⁻) -0.3 to (V _{CC} ⁺) +0.3 | V |

2 Electrical characteristics

Table 3. Electrical characteristics at $V_{CC}^+ = 2.7$ V, $T_{amb} = 25^\circ$ C (unless otherwise specified)⁽¹⁾

| Symbol | Parameter | Min. | Typ. | Max. | Unit |
|-----------------|---|-------------|------------|---------------------|------------------------------|
| V_{IO} | Input offset voltage (full common mode range) – TS7221A at $T_{min} \leq T_{amb} \leq T_{max}$ – TS7221B at $T_{min} \leq T_{amb} \leq T_{max}$ | | | 7 10 15 18 | mV |
| ΔV_{IO} | Input offset voltage drift with temperature | | 6 | | $\mu\text{V}/^\circ\text{C}$ |
| I_{IB} | Input bias current ⁽²⁾ at $T_{min} \leq T_{amb} \leq T_{max}$ | | 1 | 300 600 | pA |
| I_{IO} | Input offset current ⁽²⁾ at $T_{min} \leq T_{amb} \leq T_{max}$ | | 1 | 150 300 | pA |
| CMRR | Common-mode rejection ratio ($0 < V_{icm} < 2.7$ V) | | 65 | | dB |
| PSRR | Power supply rejection ratio ($2.7 < V_{CC} < 10$ V) | | 80 | | dB |
| A_{VD} | Voltage gain ⁽³⁾ | | 240 | | dB |
| V_{icm} | Input common mode voltage range at $T_{min} \leq T_{amb} \leq T_{max}$ | -0.3 0.0 | | 3 2.7 | V |
| I_{OH} | High level output voltage ($I_{N^+} = 0.5$ V, $I_{N^-} = 0$ V and $O_{UT} = 10$ V) | | 0.1 | 500 | nA |
| V_{OL} | Low level output voltage, $I_{sink} = 5$ mA at $T_{min} \leq T_{amb} \leq T_{max}$ | | 0.2 | 0.35 0.45 | V |
| I_{CC} | Supply current Output low Output high | | 6 8 | 12 14 | μA |
| T_{PLH} | Response time low to high ($V_{ic} = 1.35$ V, $C_L = 50$ pF, $R_L = 10$ k Ω) Overdrive = 10 mV Overdrive = 100 mV | | 1.5 0.6 | | μs |
| T_{PHL} | Response time high to low ($V_{ic} = 1.35$ V, $C_L = 50$ pF, $R_L = 10$ k Ω) Overdrive = 10 mV Overdrive = 100 mV | | 1.5 0.5 | | μs |
| T_F | Fall time $C_L = 50$ pF, $R_L = 5$ k Ω , overdrive = 10 mV | | 0.3 | | μs |
| T_R | Rise time $C_L = 50$ pF, $R_L = 5$ k Ω , overdrive = 10 mV | | 0.3 | | μs |

1. Limits are 100% production-tested at $+25^\circ$ C. Behavior at temperature range limits is guaranteed through correlation and by design.
2. Maximum values include unavoidable inaccuracies of industrial testing.
3. Design evaluation.

Table 4. Electrical characteristics for $V_{CC}^+ = 5\text{ V}$, $T_{amb} = 25^\circ\text{C}$ (unless otherwise specified)⁽¹⁾

| Symbol | Parameter | Min. | Typ. | Max. | Unit |
|-----------------|--|-------------|----------|---------------------|------------------------------|
| V_{IO} | Input offset voltage (full common mode range) – TS7221A at $T_{min} \leq T_{amb} \leq T_{max}$ – TS7221B $T_{min} \leq T_{amb} \leq T_{max}$ | | | 7 10 15 18 | mV |
| ΔV_{IO} | Input offset voltage drift with temperature | | 6 | | $\mu\text{V}/^\circ\text{C}$ |
| I_{IB} | Input bias current ⁽²⁾ at $T_{min} \leq T_{amb} \leq T_{max}$ | | 1 | 300 600 | pA |
| I_{IO} | Input offset current ⁽²⁾ at $T_{min} \leq T_{amb} \leq T_{max}$ | | 1 | 150 300 | pA |
| CMRR | Common-mode rejection ratio ($0 < V_{icm} < 5\text{ V}$) | | 70 | | dB |
| PSRR | Power supply rejection ratio ($2.7 < V_{CC} < 10\text{ V}$) | | 80 | | dB |
| A_{VD} | Voltage gain ⁽³⁾ | | 240 | | dB |
| V_{icm} | Input common mode voltage range at $T_{min} \leq T_{amb} \leq T_{max}$ | -0.3 0.0 | | 5.3 5.0 | V |
| I_{OH} | High level output voltage ($I_{N^+} = 0.5\text{ V}$, $I_{N^-} = 0\text{ V}$ and $OUT = 10\text{ V}$) | | 0.1 | 500 | nA |
| V_{OL} | Low level output voltage, $I_{sink} = 5\text{ mA}$ at $T_{min} \leq T_{amb} \leq T_{max}$ | | 0.2 | 0.40 0.55 | V |
| I_{CC} | Supply current Output low Output high | | 6 8 | 12 14 | μA |
| T_{PLH} | Response time low to high ($V_{ic} = 2.5\text{ V}$, $C_L = 50\text{ pF}$, $R_L = 10\text{ k}\Omega$) Overdrive = 10 mV Overdrive = 100 mV | | 2 0.5 | | μs |
| T_{PHL} | Response time high to low ($V_{ic} = 2.5\text{ V}$, $C_L = 50\text{ pF}$, $R_L = 10\text{ k}\Omega$) Overdrive = 10 mV Overdrive = 100 mV | | 2 0.4 | | μs |
| T_F | Fall time $C_L = 50\text{ pF}$, $R_L = 5\text{ k}\Omega$, overdrive = 10 mV | | 0.3 | | μs |
| T_R | Rise time $C_L = 50\text{ pF}$, $R_L = 5\text{ k}\Omega$, overdrive = 10 mV | | 0.3 | | μs |

1. Limits are 100% production-tested at $+25^\circ\text{C}$. Behavior at temperature range limits is guaranteed through correlation and by design.
2. Maximum values include unavoidable inaccuracies of industrial testing.
3. Design evaluation.

Table 5. Electrical characteristics for $V_{CC^+} = 10\text{ V}$, $T_{amb} = 25^\circ\text{ C}$ (unless otherwise specified)⁽¹⁾

| Symbol | Parameter | Min. | Typ. | Max. | Unit |
|-----------------|--|-------------|----------|---------------------|------------------------------|
| V_{IO} | Input offset voltage (full common mode range) – TS7221A at $T_{min} \leq T_{amb} \leq T_{max}$ – TS7221B $T_{min} \leq T_{amb} \leq T_{max}$ | | | 7 10 15 18 | mV |
| ΔV_{IO} | Input offset voltage drift with temperature | | 6 | | $\mu\text{V}/^\circ\text{C}$ |
| I_{IB} | Input bias current ⁽²⁾ at $T_{min} \leq T_{amb} \leq T_{max}$ | | 1 | 300 600 | μA |
| I_{IO} | Input offset current ⁽²⁾ at $T_{min} \leq T_{amb} \leq T_{max}$ | | 1 | 150 300 | μA |
| CMRR | Common-mode rejection ratio ($0 < V_{icm} < 10\text{ V}$) | | 75 | | dB |
| PSRR | Power supply rejection ratio ($2.7 < V_{CC} < 10\text{ V}$) | | 80 | | dB |
| A_{VD} | Voltage gain ⁽³⁾ | | 240 | | dB |
| V_{ICM} | Input common mode voltage range at $T_{min} \leq T_{amb} \leq T_{max}$ | -0.3 0.0 | | 10.3 10.0 | V |
| I_{OH} | High level output voltage ($I_{N^+} = 0.5\text{ V}$, $I_{N^-} = 0\text{ V}$ and $OUT = 10\text{ V}$) | | 0.1 | 500 | nA |
| V_{OL} | Low level output voltage, $I_{sink} = 5\text{ mA}$ at $T_{min} \leq T_{amb} \leq T_{max}$ | | 0.2 | 0.40 0.55 | V |
| I_{CC} | Supply current Output low Output high | | 7 10 | 14 16 | μA |
| T_{PLH} | Response time low to high ($V_{ic} = 5\text{ V}$, $C_L = 50\text{ pF}$, $R_L = 10\text{ k}\Omega$) Overdrive = 10 mV Overdrive = 100 mV | | 3 0.5 | | μs |
| T_{PHL} | Response time high to low ($V_{ic} = 5\text{ V}$, $C_L = 50\text{ pF}$, $R_L = 10\text{ k}\Omega$) Overdrive = 10 mV Overdrive = 100 mV | | 4 0.4 | | μs |
| T_F | Fall time $C_L = 50\text{ pF}$, $R_L = 5\text{ k}\Omega$, overdrive = 10 mV | | 0.3 | | μs |
| T_R | Rise time $C_L = 50\text{ pF}$, $R_L = 5\text{ k}\Omega$, overdrive = 10 mV | | 0.3 | | μs |

1. Limits are 100% production-tested at $+25^\circ\text{ C}$. Behavior at temperature range limits is guaranteed through correlation and by design.
2. Maximum values include unavoidable inaccuracies of industrial testing.
3. Design evaluation.

Figure 1. Supply current vs. supply voltage (output low)

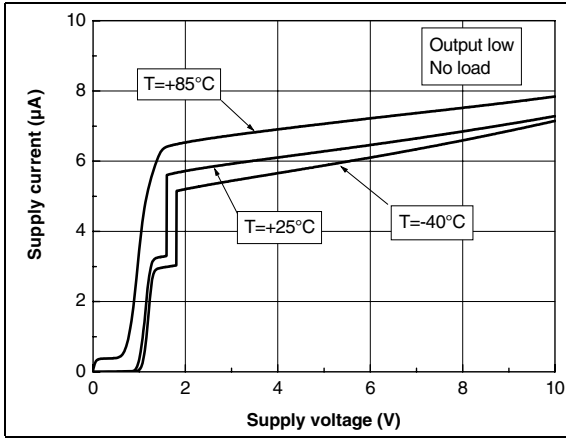

Figure 2. Supply current vs. supply voltage (output high)

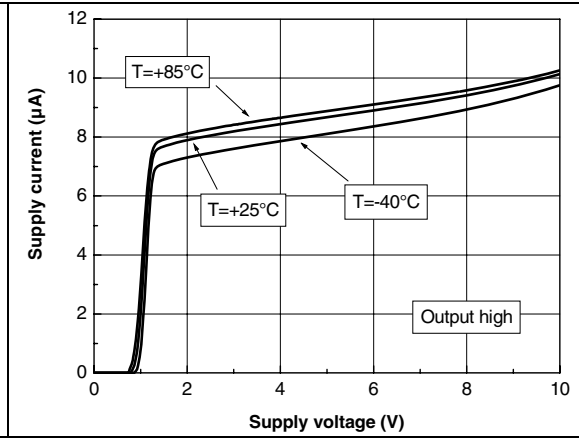

Figure 3. Output sinking current vs. output voltage at $V_{CC} = +2.7\text{ V}$, $V_{CC} = +5\text{ V}$

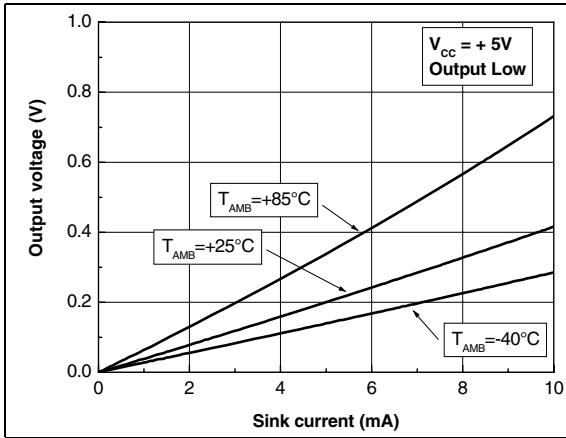

Figure 4. V_{IO} vs. V_{ICM} and temperature at $V_{CC} = 2.7\text{ V}$

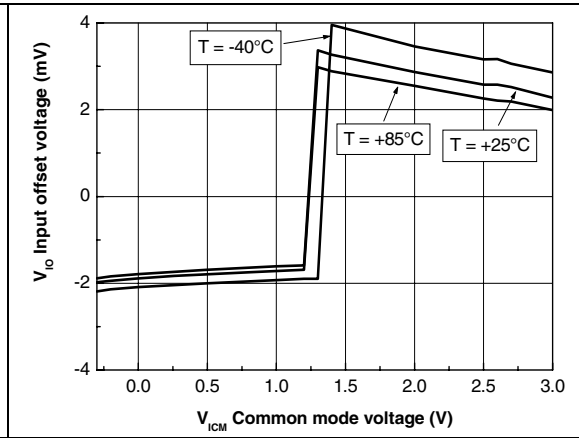

Figure 5. V_{IO} vs. V_{ICM} and temperature at $V_{CC} = 5\text{ V}$

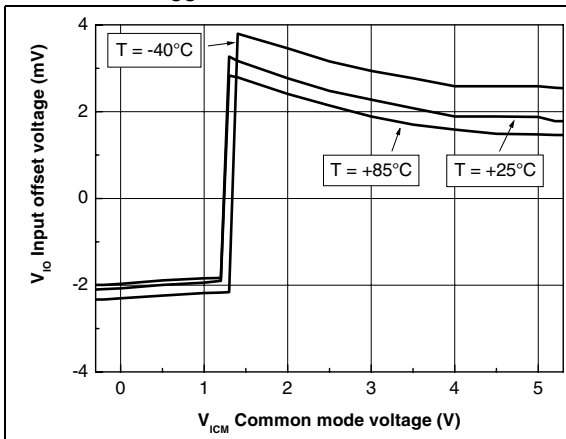

Figure 6. V_{IO} vs. V_{ICM} and temperature at $V_{CC} = 10\text{ V}$

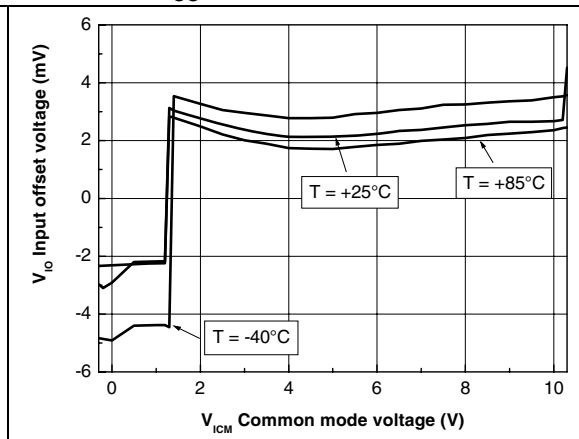

Figure 7. T_{PLH} vs V_{icm} at $V_{CC} = 10$ V and 10 mV overdrive

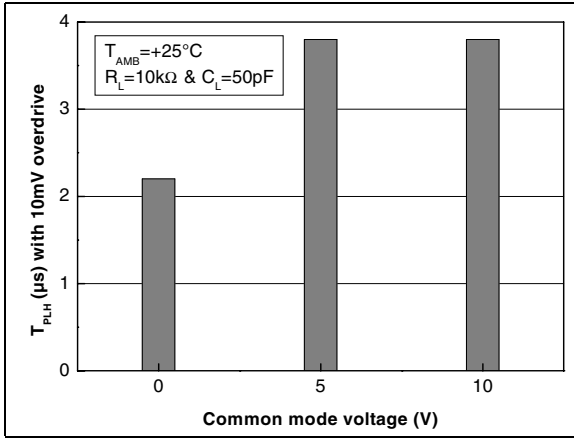

Figure 8. T_{PLH} vs V_{icm} at $V_{CC} = 10$ V and 100 mV overdrive

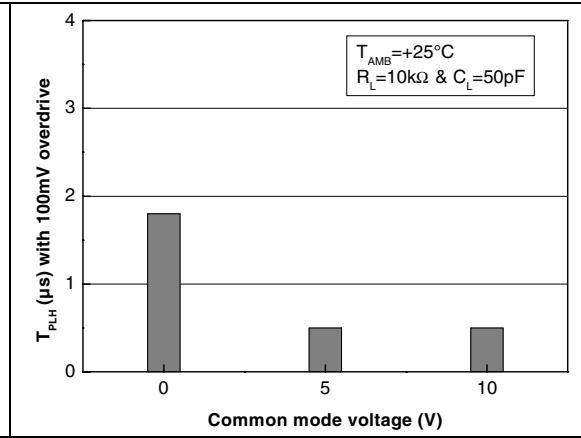

Figure 9. T_{PLH} vs V_{icm} at $V_{CC} = 5$ V and 10 mV overdrive

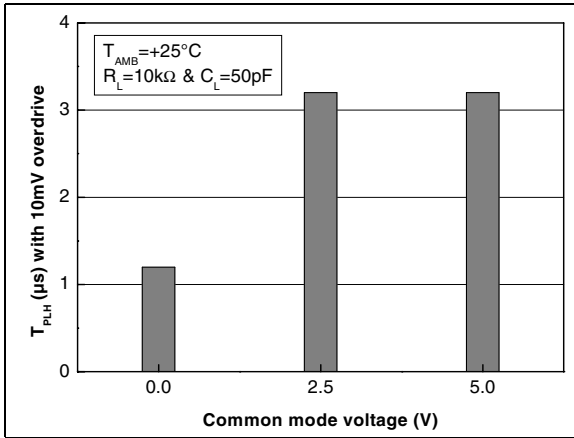

Figure 10. T_{PLH} vs V_{icm} at $V_{CC} = 5$ V and 100 mV overdrive

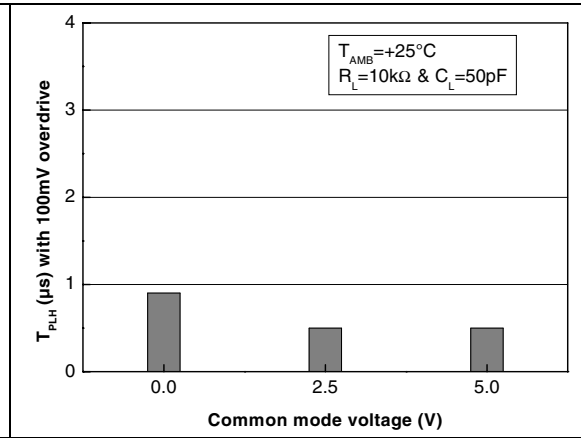

Figure 11. T_{PHL} vs V_{icm} at $V_{CC} = 10$ V and 10 mV overdrive

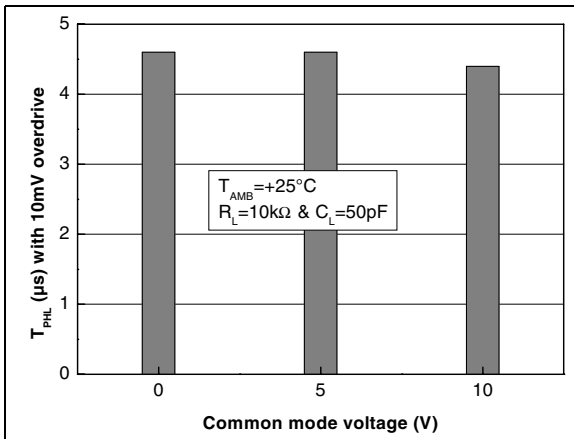

Figure 12. T_{PHL} vs V_{icm} at $V_{CC} = 10$ V and 100 mV overdrive

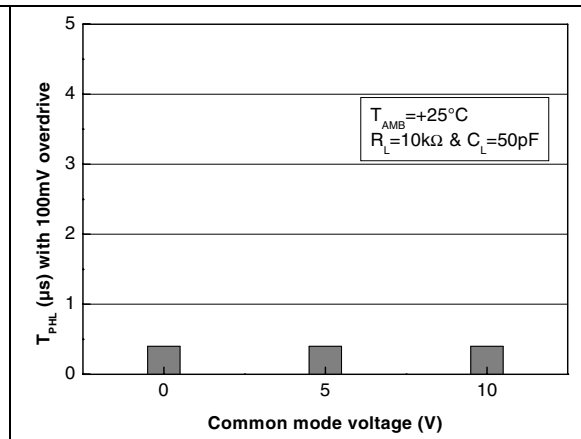
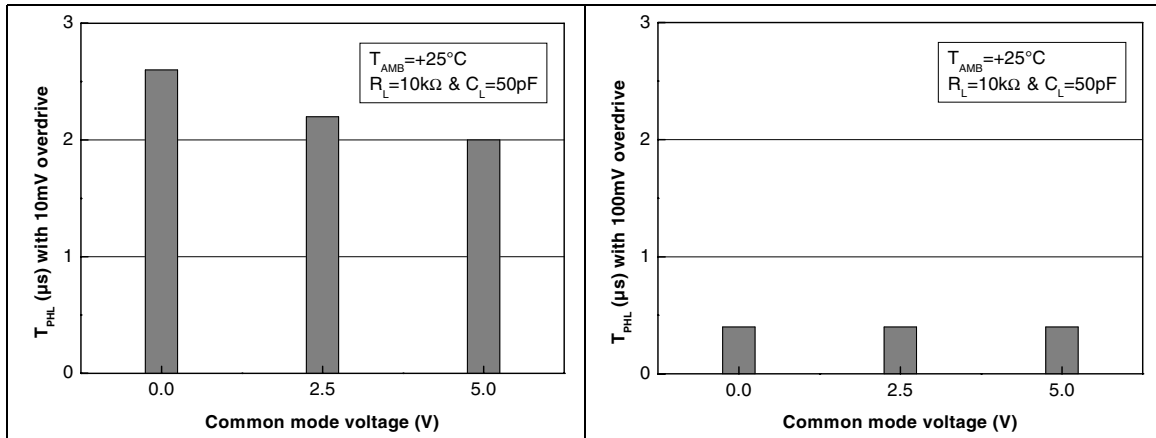

Figure 13. T_{PHL} vs V_{icm} at $V_{CC} = 5\text{ V}$ and 10 mV overdrive
Figure 14. T_{PHL} vs V_{icm} at $V_{CC} = 5\text{ V}$ and 100 mV overdrive



3 Package information

In order to meet environmental requirements, ST offers these devices in different grades of ECOPACK[®] packages, depending on their level of environmental compliance. ECOPACK[®] specifications, grade definitions and product status are available at: www.st.com. ECOPACK[®] is an ST trademark.

3.1 SOT23-5 package information

Figure 15. SOT23-5L package mechanical drawing

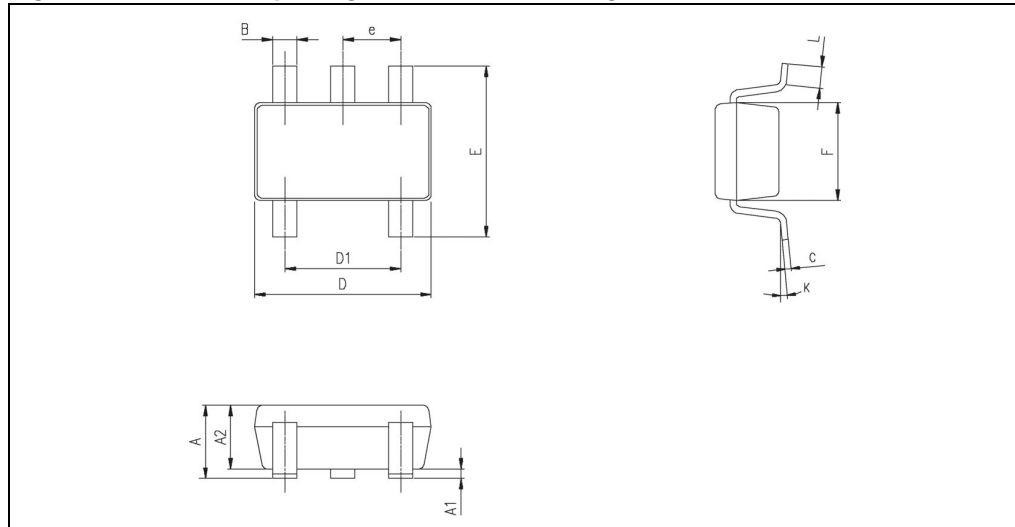

Table 6. SOT23-5L package mechanical data

| Ref. | Dimensions | | | | | |
|------|-------------|------|------------|--------|-------|-------|
| | Millimeters | | | Inches | | |
| | Min. | Typ. | Max. | Min. | Typ. | Max. |
| A | 0.90 | 1.20 | 1.45 | 0.035 | 0.047 | 0.057 |
| A1 | | | 0.15 | | | 0.006 |
| A2 | 0.90 | 1.05 | 1.30 | 0.035 | 0.041 | 0.051 |
| B | 0.35 | 0.40 | 0.50 | 0.013 | 0.015 | 0.019 |
| C | 0.09 | 0.15 | 0.20 | 0.003 | 0.006 | 0.008 |
| D | 2.80 | 2.90 | 3.00 | 0.110 | 0.114 | 0.118 |
| D1 | | 1.90 | | | 0.075 | |
| e | | 0.95 | | | 0.037 | |
| E | 2.60 | 2.80 | 3.00 | 0.102 | 0.110 | 0.118 |
| F | 1.50 | 1.60 | 1.75 | 0.059 | 0.063 | 0.069 |
| L | 0.10 | 0.35 | 0.60 | 0.004 | 0.013 | 0.023 |
| K | 0 degrees | | 10 degrees | | | |

4 Ordering information

Table 7. Order codes

| Order code | Temperature range | Package | Packing | Marking |
|------------|-------------------|----------|-------------|---------|
| TS7221AILT | -40°C, +85°C | SOT23-5L | Tape & reel | K518 |
| TS7221BILT | | | | K519 |

5 Revision history

Table 8. Document revision history

| Date | Revision | Changes |
|-------------|----------|---|
| 01-Dec-2002 | 1 | Initial release |
| 01-Sep-2005 | 2 | Update of datasheet presentation and format. Change of T_{lead} temperature in Table 1 on page 2 , to reflect change to Pb-free package. Corrections to V_{icm} upper rail parameters in Electrical characteristics tables. Addition of Pb-free information in Section 3: Package information on page 9 . Correction to package mechanical data given in Figure 15 on page 10 . |
| 26-Mar-2007 | 3 | Added automotive grade part numbers in Section 4: Ordering information on page 11 . |
| 05-Jul-2007 | 4 | Corrected automotive grade part numbers in Table 7: Order codes . |
| 27-Mar-2009 | 5 | Added notes for ESD in Table 1: Absolute maximum ratings . Added R_{thja} and R_{thjc} parameters in Table 1: Absolute maximum ratings . Removed power dissipation parameter (P_D) in Table 1: Absolute maximum ratings . Updated package information in Section 3.1 . Removed automotive grade part numbers in Table 7: Order codes . |

Please Read Carefully:

Information in this document is provided solely in connection with ST products. STMicroelectronics NV and its subsidiaries ("ST") reserve the right to make changes, corrections, modifications or improvements, to this document, and the products and services described herein at any time, without notice.

All ST products are sold pursuant to ST's terms and conditions of sale.

Purchasers are solely responsible for the choice, selection and use of the ST products and services described herein, and ST assumes no liability whatsoever relating to the choice, selection or use of the ST products and services described herein.

No license, express or implied, by estoppel or otherwise, to any intellectual property rights is granted under this document. If any part of this document refers to any third party products or services it shall not be deemed a license grant by ST for the use of such third party products or services, or any intellectual property contained therein or considered as a warranty covering the use in any manner whatsoever of such third party products or services or any intellectual property contained therein.

UNLESS OTHERWISE SET FORTH IN ST'S TERMS AND CONDITIONS OF SALE ST DISCLAIMS ANY EXPRESS OR IMPLIED WARRANTY WITH RESPECT TO THE USE AND/OR SALE OF ST PRODUCTS INCLUDING WITHOUT LIMITATION IMPLIED WARRANTIES OF MERCHANTABILITY, FITNESS FOR A PARTICULAR PURPOSE (AND THEIR EQUIVALENTS UNDER THE LAWS OF ANY JURISDICTION), OR INFRINGEMENT OF ANY PATENT, COPYRIGHT OR OTHER INTELLECTUAL PROPERTY RIGHT.

UNLESS EXPRESSLY APPROVED IN WRITING BY AN AUTHORIZED ST REPRESENTATIVE, ST PRODUCTS ARE NOT RECOMMENDED, AUTHORIZED OR WARRANTED FOR USE IN MILITARY, AIR CRAFT, SPACE, LIFE SAVING, OR LIFE SUSTAINING APPLICATIONS, NOR IN PRODUCTS OR SYSTEMS WHERE FAILURE OR MALFUNCTION MAY RESULT IN PERSONAL INJURY, DEATH, OR SEVERE PROPERTY OR ENVIRONMENTAL DAMAGE. ST PRODUCTS WHICH ARE NOT SPECIFIED AS "AUTOMOTIVE GRADE" MAY ONLY BE USED IN AUTOMOTIVE APPLICATIONS AT USER'S OWN RISK.

Resale of ST products with provisions different from the statements and/or technical features set forth in this document shall immediately void any warranty granted by ST for the ST product or service described herein and shall not create or extend in any manner whatsoever, any liability of ST.

ST and the ST logo are trademarks or registered trademarks of ST in various countries.

Information in this document supersedes and replaces all information previously supplied.

The ST logo is a registered trademark of STMicroelectronics. All other names are the property of their respective owners.

© 2009 STMicroelectronics - All rights reserved

STMicroelectronics group of companies

Australia - Belgium - Brazil - Canada - China - Czech Republic - Finland - France - Germany - Hong Kong - India - Israel - Italy - Japan - Malaysia - Malta - Morocco - Singapore - Spain - Sweden - Switzerland - United Kingdom - United States of America

www.st.com

