

LMC8101

Rail-to-Rail Input and Output, 2.7V Op Amp in micro SMD package with Shutdown

General Description

The LMC8101 is a Rail-to-Rail Input and Output high performance CMOS operational amplifier. The LMC8101 is ideal for low voltage (2.7V to 10V) applications requiring Rail-to-Rail inputs and output. The LMC8101 is supplied in the die sized micro SMD as well as the 8 pin MSOP packages. The micro SMD package requires 75% less board space as compared to the SOT23-5 package. The LMC8101 is an upgrade to the industry standard LMC7101.

The LMC8101 incorporates a simple user controlled methodology for shutdown. This allows ease of use while reducing the total supply current to 1nA typical. This extends battery life where power saving is mandated. The shutdown input threshold can be set relative to either V^+ or V^- using the SL pin (see Application Note section for details).

Other enhancements include improved offset voltage limit, three times the output current drive and lower 1/f noise when compared to the industry standard LMC7101 Op Amp. This makes the LMC8101 ideal for use in many battery powered, wireless communication and Industrial applications.

Features

$V_S = 2.7V$, $T_A = 25^\circ C$, R_L to $V^+/2$, Typical values unless specified.

- Rail-to-Rail Inputs
- Rail-to-Rail Output Swing Within 35mV of Supplies ($R_L = 2k\Omega$)
- Packages Offered:
 - micro SMD package 1.39mm x 1.41mm
 - MSOP package 3.0mm x 4.9mm
- Low Supply Current <1mA (max)
- Shutdown Current 1 μ A (max)
- Versatile Shutdown feature 10 μ s turn-on
- Output Short Circuit Current 10mA
- Offset Voltage ± 5 mV (max)
- Gain-Bandwidth 1MHz
- Supply Voltage Range 2.7V-10V
- THD 0.18%
- Voltage Noise $36 \frac{nV}{\sqrt{Hz}}$

Applications

- Portable Communication (voice, data)
- Cellular Phone Power Amp Control Loop
- Buffer AMP
- Active Filters
- Battery Sense
- VCO Loop

Connection Diagrams

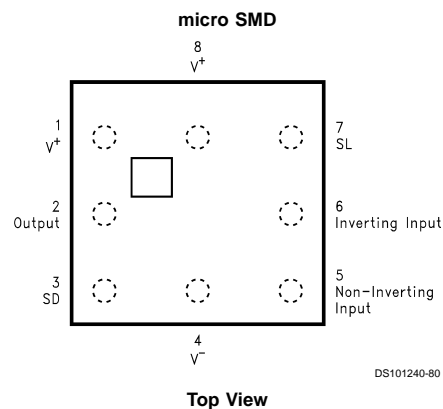
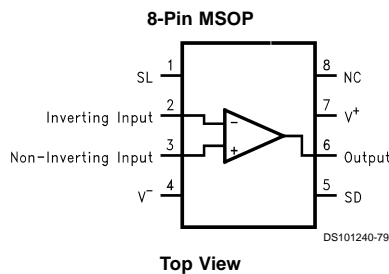

Ordering Information

Package	Ordering Information	NSC Drawing Number	Package Marking	Supplied As
micro SMD	LMC8101BP	BPA08EFB	A	250 Units Tape and Reel
	LMC8101BPX		2	3k Units Tape and Reel
8-Pin MSOP	LMC8101MM	MUA08A	A11	1k Units Tape and Reel
	LMC8101MMX			3.5k Units Tape and Reel

Absolute Maximum Ratings (Note 1)

If Military/Aerospace specified devices are required, please contact the National Semiconductor Sales Office/Distributors for availability and specifications.

ESD Tolerance	2KV (Note 2) 200V (Note 13)
V _{IN} differential	+/-Supply Voltage
Output Short Circuit Duration	(Notes 3, 11)
Supply Voltage (V ⁺ - V ⁻)	12V
Voltage at Input/Output pins	V ⁺ +0.8V, V ⁻ -0.8V
Current at Input Pin	+/-10mA
Current at Output Pin (Notes 3, 12)	+/-80mA
Current at Power Supply pins	+/-80mA

Storage Temperature Range	-65°C to +150°C
Junction Temperature(Note 4)	+150°C
Soldering Information	
Infrared or Convection (20 sec.)	235°C
Wave Soldering (10 sec.)	260°C

Operating Ratings (Note 1)

Supply Voltage (V ⁺ - V ⁻)	2.7V to 10V
Junction Temperature Range (Note 4)	-40°C to +85°C
Package Thermal Resistance (θ _{JA}) (Note 4)	
micro SMD	220°C/W
MSOP pkg. 8 pin Surface Mount	230°C/W

2.7V Electrical Characteristics

Unless otherwise specified, all limits guaranteed for T_J = 25°C, V⁺ = 2.7V, V⁻ = 0V, V_{CM} = V_O = V⁺/2 and R_L > 1 MΩ to V⁺/2. **Boldface** limits apply at the temperature extremes.

Symbol	Parameter	Conditions	Typ (Note 5)	Limit (Note 6)	Units
V _{OS}	Input Offset Voltage		±0.70	±5 ±7	mV max
TCV _{OS}	Input Offset Voltage Average Drift		4		µV/°C
I _B	Input Bias Current	(Note 7)	±1	±64	pA max
I _{OS}	Input Offset Current		0.5	32	pA max
R _{in CM}	Input Common Mode Resistance		10		GΩ
C _{in CM}	Input Common Mode Capacitance		10		pF
CMRR	Common Mode Rejection Ratio	0V <= V _{CM} <= 2.7V	78	60	dB min
		V _S = 3V 0V <= V _{CM} <= 3V	78	64 60	
PSRR	Power Supply Rejection Ratio	V _S = 2.7V to 3V	57	50 48	dB min
CMVR	Input Common-Mode Voltage Range	V _S = 2.7V CMRR > = 50dB	0.0	0.0	V max
			3.0	2.7	V min
		V _S = 3V CMRR > = 50dB	-0.2	-0.1	V max
			3.2	3.1	V min
A _{VOL}	Large Signal Voltage Gain	Sourcing R _L = 2kΩ to V ⁺ /2 V _O = 1.35V to 2.45V	3162	1000 562	V/V min
			3162	804 562	
		Sinking R _L = 2kΩ to V ⁺ /2 V _O = 1.35V to 0.25V	4000	1778 1000	V/V min
			4000	1778 1000	

2.7V Electrical Characteristics (Continued)

Unless otherwise specified, all limits guaranteed for $T_J = 25^\circ\text{C}$, $V^+ = 2.7\text{V}$, $V^- = 0\text{V}$, $V_{\text{CM}} = V_O = V^+/2$ and $R_L > 1\text{M}\Omega$ to $V^+/2$. **Boldface** limits apply at the temperature extremes.

Symbol	Parameter	Conditions	Typ (Note 5)	Limit (Note 6)	Units
V_O	Output Swing High	$R_L = 2\text{k}\Omega$ to $V^+/2$ $V_{\text{ID}} = 100\text{mV}$	2.67	2.64 2.62	V min
		$R_L = 10\text{k}\Omega$ to $V^+/2$ $V_{\text{ID}} = 100\text{mV}$	2.69	2.68 2.67	V min
	Output Swing Low	$R_L = 2\text{k}\Omega$ to $V^+/2$ $V_{\text{ID}} = -100\text{mV}$	32	100 150	mV max
		$R_L = 10\text{k}\Omega$ to $V^+/2$ $V_{\text{ID}} = -100\text{mV}$	10	30 70	mV max
I_{SC}	Output Short Circuit Current	Sourcing to $V^+/2$ $V_{\text{ID}} = 100\text{mV}$ (Note 11)	20	14 6	mA min
		Sinking to $V^+/2$ $V_{\text{ID}} = -100\text{mV}$ (Note 11)	10	5 4	mA min
I_S	Supply Current	No load, normal operation	0.70	1.0 1.2	mA max
		Shutdown mode	0.001	1	μA max
T_{on}	Shutdown Turn-on time	(Note 9)	10	15	μs
T_{off}	Shutdown Turn-off time	(Note 9)	1		μs
I_{in}	"SL" and "SD" Input Current		± 1	± 64	pA max
SR	Slew Rate (Note 8)	$A_V = +1$, $R_L = 10\text{k}\Omega$ to $V^+/2$ $V_i = 1V_{\text{PP}}$	1	0.8	V/ μs min
f_u	Unity Gain-Bandwidth	$V_i = 10\text{mV}$, $R_L = 2\text{k}\Omega$ to $V^+/2$	750		KHz
GBW	Gain Bandwidth Product	$f = 100\text{KHz}$	1		MHz
e_n	Input-Referred Voltage Noise	$f = 10\text{KHz}$, $R_S = 50\Omega$	36		$\frac{\text{nV}}{\sqrt{\text{Hz}}}$
i_n	Input-Referred Current Noise	$f = 10\text{KHz}$	1.5		$\frac{\text{fA}}{\sqrt{\text{Hz}}}$
THD	Total Harmonic Distortion	$f = 1\text{KHz}$, $A_V = +1$, $V_O = 2.2V_{\text{PP}}$, $R_L = 600\Omega$ to $V^+/2$	0.18		%

+/-5V Electrical Characteristics

Unless otherwise specified, all limits guaranteed for $T_J = 25^\circ\text{C}$, $V^+ = 5\text{V}$, $V^- = -5\text{V}$, $V_{\text{CM}} = V_O = 0\text{V}$, and $R_L > 1\text{M}\Omega$ to gnd. **Boldface** limits apply at the temperature extremes.

Symbol	Parameter	Conditions	Typ (Note 5)	Limit (Note 6)	Units
V_{OS}	Input Offset Voltage		± 0.7	± 5 ± 7	mV max
TCV_{OS}	Input Offset Voltage Average Drift		4		$\mu\text{V}/^\circ\text{C}$
I_B	Input Bias Current	(Note 7)	± 1	± 64	pA max
I_{OS}	Input Offset Current		0.5	32	pA max
$R_{\text{in CM}}$	Input Common Mode Resistance		10		G Ω
$C_{\text{in CM}}$	Input Common Mode Capacitance		10		pF
CMRR	Common-Mode Rejection Ratio	$-5\text{V} < V_{\text{CM}} < 5\text{V}$	87	70 67	dB min

+/-5V Electrical Characteristics (Continued)

Unless otherwise specified, all limits guaranteed for $T_J = 25^\circ\text{C}$, $V^+ = 5\text{V}$, $V^- = -5\text{V}$, $V_{CM} = V_O = 0\text{V}$, and $R_L > 1\text{M}\Omega$ to gnd. **Boldface** limits apply at the temperature extremes.

Symbol	Parameter	Conditions	Typ (Note 5)	Limit (Note 6)	Units
PSRR	Power Supply Rejection Ratio	$V_S = 5\text{V to } 10\text{V}$	80	76 72	dB min
CMVR	Input Common-Mode Voltage Range	CMRR $\geq 50\text{ dB}$	-5.3	-5.2 -5.0	V max
			5.3	5.2 5.0	V min
A_{VOL}	Large Signal Voltage Gain	Sourcing $R_L = 600\Omega$ $V_O = 0\text{V to } 4\text{V}$	34.5	17.8 10	V/mV min
		Sinking $R_L = 600\Omega$ $V_O = 0\text{V to } -4\text{V}$	34.5	17.8 3.16	
		Sourcing $R_L = 2\text{k}\Omega$ $V_O = 0\text{V to } 4.6\text{V}$	138	31.6 17.8	V/mV min
		Sinking $R_L = 2\text{k}\Omega$ $V_O = 0\text{V to } -4.6\text{V}$	138	31.6 10	
V_O	Output Swing High	$R_L = 600\Omega$ $V_{ID} = 100\text{mV}$	4.73	4.60 4.54	V min
		$R_L = 2\text{k}\Omega$ $V_{ID} = 100\text{mV}$	4.90	4.85 4.83	V min
	Output Swing Low	$R_L = 600\Omega$ $V_{ID} = -100\text{mV}$	-4.85	-4.75 -4.65	V max
		$R_L = 2\text{k}\Omega$ $V_{ID} = -100\text{mV}$	-4.95	4.90 -4.84	V max
I_{SC}	Output Short Circuit Current	Sourcing, $V_{ID} = 100\text{mV}$ (Note 3),(Note 11)	49	30 25	mA min
		Sinking, $V_{ID} = -100\text{mV}$ (Note 3),(Note 11)	90	60 52	mA min
I_S	Supply Current	No load, normal operation	1.1	1.7 1.9	mA max
		Shutdown mode	0.001	1	μA
T_{on}	Shutdown Turn-on time	(Note 9)	10	15	μs
T_{off}	Shutdown Turn-off time	(Note 9)	1		μs
I_{in}	"SL" and "SD" Input Current		± 1	± 64	pA max
SR	Slew Rate (Note 8)	$A_V = +10$, $R_L = 10\text{k}\Omega$, $V_O = 10\text{Vpp}$, $C_L = 1000\text{pF}$	1.2		V/ μs
f_u	Unity Gain-Bandwidth	$V_I = 10\text{mV}$ $R_L = 2\text{k}\Omega$	840		KHz
GBW	Gain Bandwidth Product	$f = 10\text{KHz}$	1.3		MHz
e_n	Input-Referred Voltage Noise	$f = 10\text{KHz}$, $R_S = 50\Omega$	33		$\frac{\text{nV}}{\sqrt{\text{Hz}}}$
i_n	Input-Referred Current Noise	$f = 10\text{KHz}$	1.5		$\frac{\text{fA}}{\sqrt{\text{Hz}}}$
THD	Total Harmonic Distortion	$f = 10\text{KHz}$, $A_V = +1$, $V_O = 8\text{Vpp}$, $R_L = 600\Omega$	0.2		%

+/-5V Electrical Characteristics (Continued)

Note 1: Absolute Maximum Ratings indicate limits beyond which damage to the device may occur. Operating Ratings indicate conditions for which the device is intended to be functional, but specific performance is not guaranteed. For guaranteed specifications and the test conditions, see the Electrical Characteristics.

Note 2: Human body model, 1.5kΩ in series with 100pF.

Note 3: Applies to both single-supply and split-supply operation. Continuous short circuit operation at elevated ambient temperature can result in exceeding the maximum allowed junction temperature at 150°C. Output currents in excess of 40mA over long term may adversely affect reliability.

Note 4: The maximum power dissipation is a function of $T_{J(max)}$, θ_{JA} and T_A . The maximum allowable power dissipation at any ambient temperature is $P_D = (T_{J(max)} - T_A)/\theta_{JA}$. All numbers apply for packages soldered directly onto a PC board.

Note 5: Typical Values represent the most likely parametric norm.

Note 6: All limits are guaranteed by testing or statistical analysis.

Note 7: Positive current corresponds to current flowing into the device.

Note 8: Slew rate is the slower of the rising and falling slew rates.

Note 9: Shutdown Turn-on and Turn-off times are defined as the time required for the output to reach 90% and 10%, respectively, of its final peak to peak swing when set for Rail to Rail output swing with a 100kHz sine wave, 2kΩ load, and $A_V = +10$.

Note 10: Limiting input pin current is only necessary for input voltages that exceed absolute maximum input voltage ratings.

Note 11: Short circuit test is a momentary test. See Note 12.

Note 12: Output short circuit duration is infinite for $V_S < 6V$. Otherwise, extended period output short circuit may damage the device.

Note 13: machine Model, 0Ω in series with 200pF.

Application Notes

Shutdown features:

The LMC8101 is capable of being turned off in order to conserve power. Once in shutdown, the device supply current is drastically reduced (1μA maximum) and the output will be "Tri-stated".

The shutdown feature of the LMC8101 is designed for flexibility. The threshold level of the SD input can be referenced to either V^- or V^+ by setting the level on the SL input. When the SL input is connected to V^- , the SD threshold level is referenced to V^- and vice versa. This threshold will be about 1.5V from the supply tied to the SL pin. So, for this example, the device will be in shutdown as long as the SD pin voltage is within 1V of V^- . In order to ensure that the device would not "chatter" between active and shutdown states, hysteresis is built into the SD pin transition (see Figure 1 for an illustration of this feature). The shutdown threshold and hysteresis level are independent of the supply voltage. Figure 1 illustration applies equally well to the case when SL is tied to V^+ and the horizontal axis is referenced to V^+ instead. The SD pin should not be set within the voltage range from 1.1V to 1.9V of the selected supply voltage since this is a transition region and the device status will be undetermined.

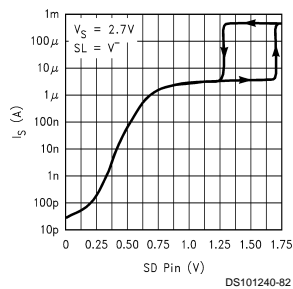

FIGURE 1. Supply Current vs. 'SD' Voltage

Table 1, below, summarizes the status of the device when the SL and SD pins are connected directly to V^- or V^+ :

TABLE 1. LMC8101 Status Summary

SL	SD	LMC8101 Status
V^-	V^-	Shutdown
V^-	V^+	Active
V^+	V^+	Shutdown
V^+	V^-	Active

In case shutdown operation is not needed, as can be seen in Table 1, the two pins SL and SD can simply be connected to opposite supply nodes to achieve "Active" operation. The SL and SD should always be tied to a node; if left unconnected, these high impedance inputs will float to an undetermined state and the device status will be undetermined as well.

With the device in shutdown, once "Active" operation is initiated, there will be a finite amount of time required before the device output is settled to its final value. This time is less than 15μs. In addition, there may be some output spike during this time while the device is transitioning into a fully operational state. Some applications may be sensitive to this output spike and proper precautions should be taken in order to ensure proper operation at all times.

Tiny Package:

The LMC8101 is available in the micro SMD package as well as the 8 pin MSOP package. The micro SMD package requires approximately 1/4 the board area of a SOT23. This package is less than 1mm in height allowing it to be placed in absolute minimum height clearance areas such as cellular handsets, LCD panels, PCMCIA cards, etc. More information about the micro SMD package can be found at: <http://www.national.com/appinfo/microsmd>.

Application Notes (Continued)

Conversion Boards:

In order to ease the evaluation of tiny packages such as the micro SMD, there is a conversion board (LMC8101CONV) available to board designers. This board converts a micro SMD device into an 8 pin DIP package (see Figure 2, Conversion Board Pin out diagram) for easier handling and evaluation. This board can be ordered from National Semiconductor by contacting <http://www.national.com>.

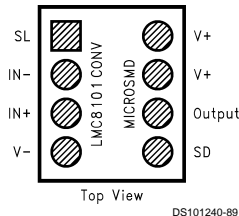

FIGURE 2. micro SMD Conversion Board pin-out

Increased Output Current:

Compared to the LMC7101, the LMC8101 has an improved output stage capable of up to three times larger output sourcing and sinking current. This improvement would allow a larger output voltage swing range compared to the LMC7101 when connected to relatively heavy loads. For lower supply voltages this is an added benefit since it increases the output swing range. For example, the LMC8101 can typically swing 2.5Vpp with 2mA sourcing and sinking output current ($V_s = 2.7V$) whereas the LMC7101 output swing would be limited to 1.9Vpp under the same conditions. Also, compared to the LMC7101 in the SOT23 package, the LMC8101 can dissipate more power because both the MSOP and the micro SMD packages have 40% better heat dissipation capability.

Lower 1/f noise:

The dominant input referred noise term for the LMC8101 is the input noise voltage. Input noise current for this device is of no practical significance unless the equivalent resistance it looks into is 5M Ω or higher.

The LMC8101's low frequency noise is significantly lower than that of the LMC7101. For example, at 10Hz, the input referred spot noise voltage density is 85 nV/Hz as compared to about 200nV/Hz for the LMC7101. Over a frequency range of 0.1Hz to 100Hz, the total noise of the LMC8101 will be approximately 60% less than that of the LMC7101.

Lower THD:

When connected to heavier loads, the LMC8101 has lower THD compared to the LMC7101. For example, with 5V supply at 10KHz and 2Vpp swing ($A_v = -2$), the LMC8101 THD (0.2%) is 60% less than the LMC7101's. The LMC8101 THD can be kept below 0.1% with 3Vpp at the output for up to 10KHz (refer to the Typical Characteristics Plots).

Improving the Cap load drive capability:

This can be accomplished in several ways:

- Output resistive loading increase:

The Phase Margin increases with increasing load (refer to the Typical Characteristics Plots). When driving capacitive loads, stability can generally be improved by allowing some output current to flow through a load. For example, the cap

load drive capability can be increased from 8200pF to 16000pF if the output load is increased from 5K Ω to 600 Ω ($A_v = +10$, 25% overshoot limit, 10V supply).

- Isolation resistor between output and cap load:

This resistor will isolate the feedback path (where excessive phase shift due to output capacitance can cause instability) from the capacitive load. With a 10V supply, a 100 Ω isolation resistor allows unlimited capacitive load without oscillation compared to only 300pF without this resistor ($A_v = +1$).

- Higher supply voltage:

Operating the LMC8101 at higher supply voltages allows higher cap load tolerance. At 10V, the LMC8101's low supply voltage cap load limit of 300pF improves to about 600pF ($A_v = +1$).

- Closed loop gain increase:

As with all Op Amps, the capacitive load tolerance of the LMC8101 increases with increasing closed loop gain. In applications where the load is mostly capacitive and the resistive loading is light, stability increases when the LMC8101 is operated at a closed loop gain larger than +1.

Typical Performance Characteristics $V_S = 2.7V$, Single Supply, $V_{CM} = V^+/2$, $T_A = 25^\circ C$ unless specified

Gain/Phase vs. Frequency
 $R_L = 2k, V_S = \pm 1.35V$

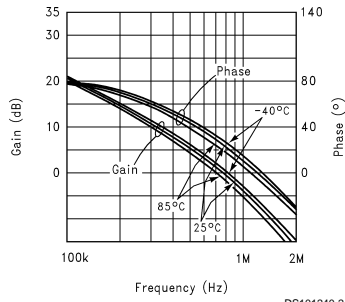

Gain/Phase vs. Frequency
 $R_L = 2k, V_S = \pm 5V$

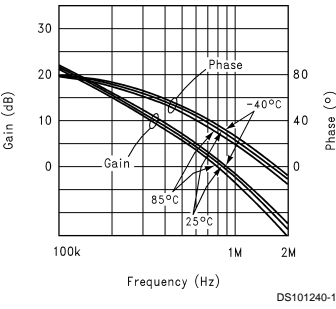

Gain/Phase vs. Frequency
 $R_L = \text{open}$

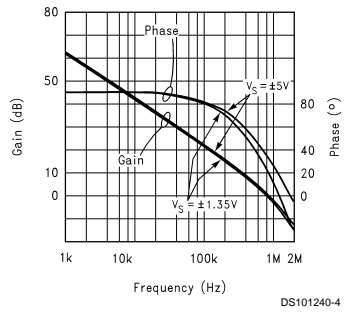

Gain vs. Phase for various C_L
 $V_S = \pm 1.35V$

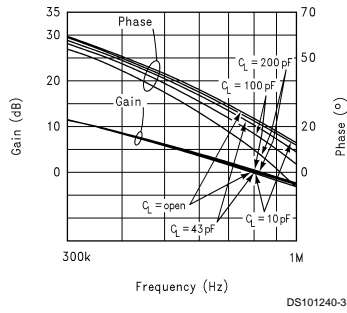

Unity Gain Frequency vs. Supply Voltage

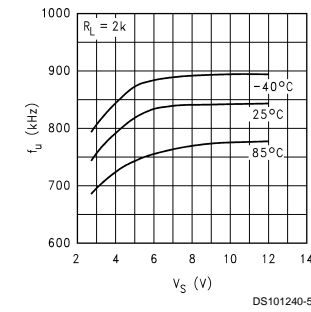

Phase Margin vs. Supply Voltage

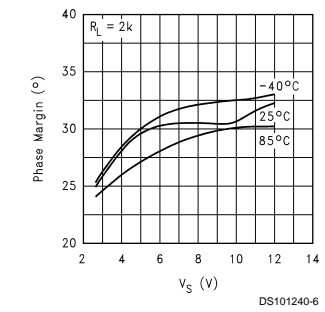

Unity Gain Frequency and Phase Margin vs. Load

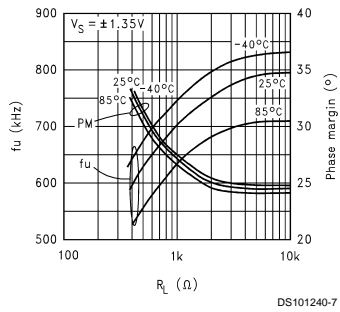

Unity Gain Frequency and Phase Margin vs. Load

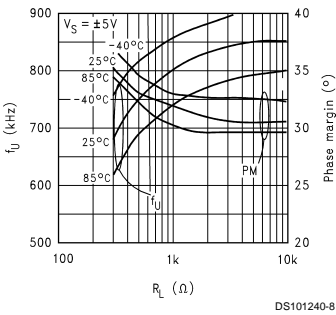

PSRR vs. Frequency

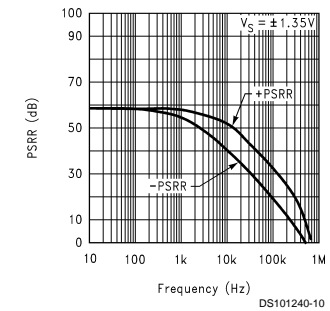

Typical Performance Characteristics $V_S = 2.7V$, Single Supply, $V_{CM} = V^+/2$, $T_A = 25^\circ C$ unless specified (Continued)

PSRR vs. Frequency

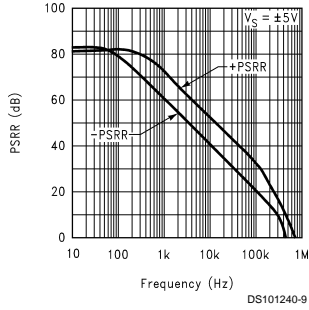

CMRR vs. Frequency

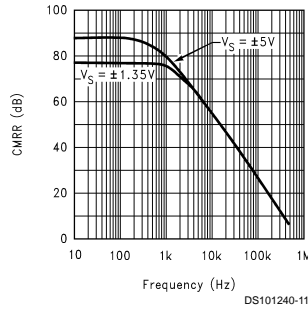

Input Bias Current vs. Common Mode Voltage @ 85°C

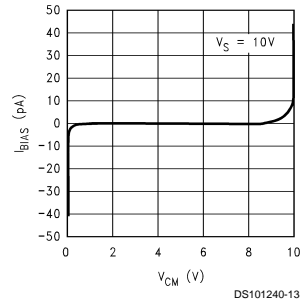

Input Current vs. Temperature
 $V_S = 10V$

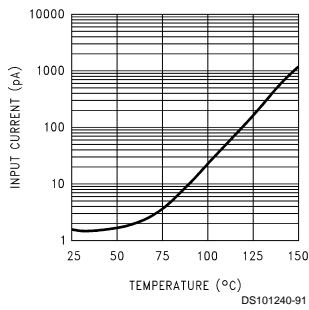

V_{in} vs. V_{out}

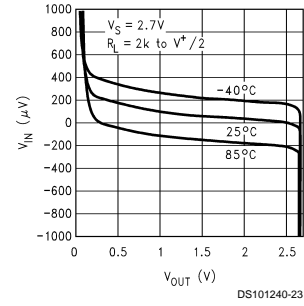

V_{in} vs. V_{out}

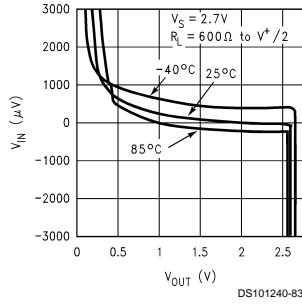

V_{in} vs. V_{out}

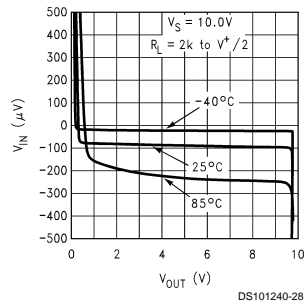

V_{in} vs. V_{out}

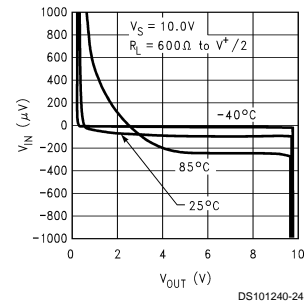

Supply Current vs. Supply Voltage

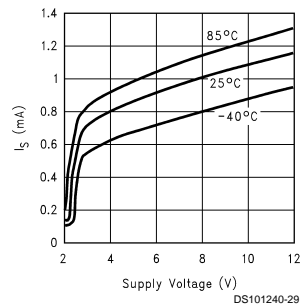

Typical Performance Characteristics $V_S = 2.7V$, Single Supply, $V_{CM} = V^+/2$, $T_A = 25^\circ C$ unless specified (Continued)

Delta V_{OS} vs. V_{CM}
(Ref $V_{CM} = 1.35V$)

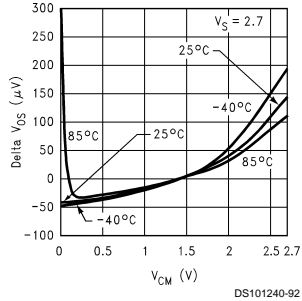

Delta V_{OS} vs. V_{CM}
(Ref $V_{CM} = 5V$)

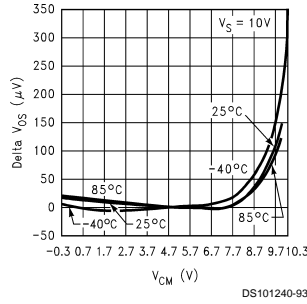

Offset Voltage vs. V_{SUPPLY}

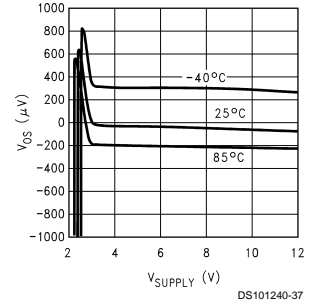

Output Positive Swing vs. Supply Voltage, $R_L = 600\Omega$ to $V^+/2$

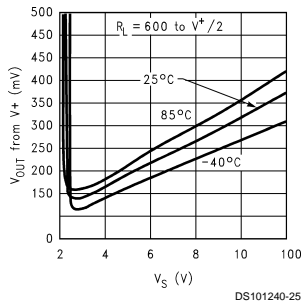

Output Positive Swing vs. Supply Voltage $R_L = 2k$ to $V^+/2$

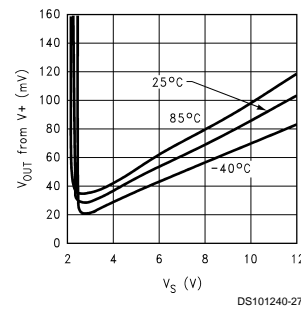

Output Negative Swing vs. Supply Voltage, $R_L = 600\Omega$ to $V^+/2$

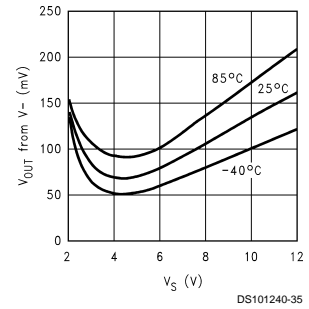

Output Negative Swing vs. Supply Voltage, $R_L = 2k$ to $V^+/2$

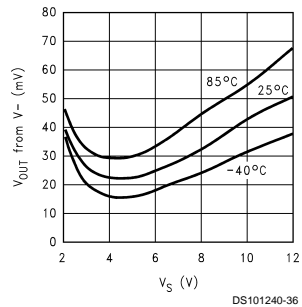

Short Circuit Sinking Current vs. Supply Voltage

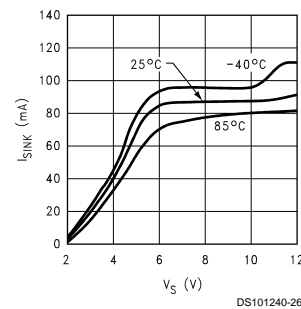

Short Circuit Sourcing Current vs. Supply Voltage

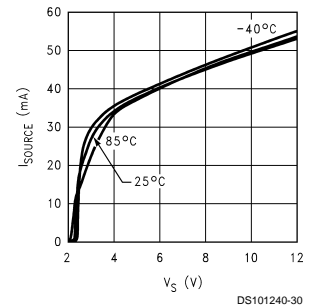

Typical Performance Characteristics $V_S = 2.7V$, Single Supply, $V_{CM} = V^+/2$, $T_A = 25^\circ C$ unless specified (Continued)

Undistorted Output Voltage Swing vs. Output Load Resistance

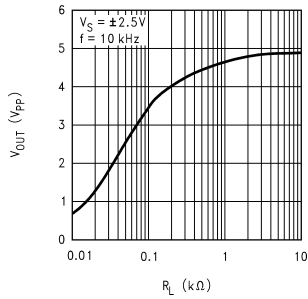

Step Response 1% settling time and % overshoot vs. Cap Load

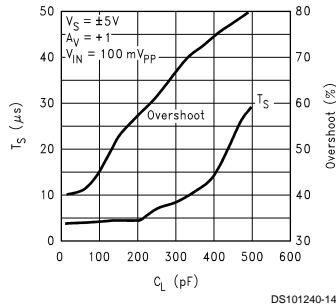

Large Signal Step Response

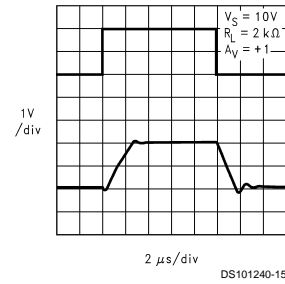

Small Signal Step Response

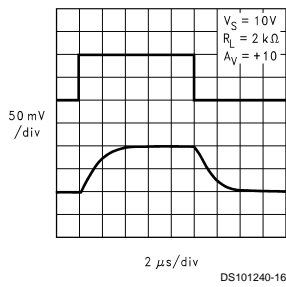

Large Signal Step Response

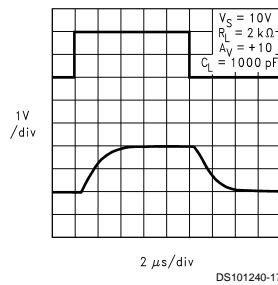

Small Signal Step Response

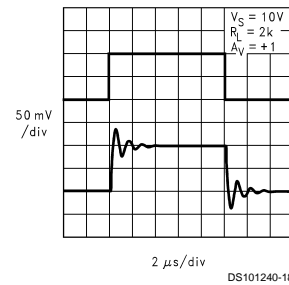

Small Signal Step Response

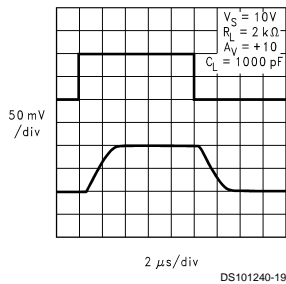

Large Signal Step Response

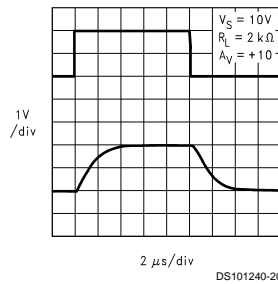

Large Signal Step Response

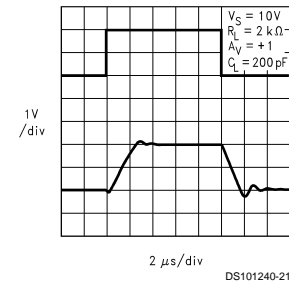

Typical Performance Characteristics $V_S = 2.7V$, Single Supply, $V_{CM} = V^+/2$, $T_A = 25^\circ C$ unless specified (Continued)

Small Signal Step Response

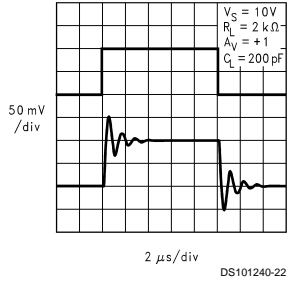

Slew Rate vs. Supply Voltage

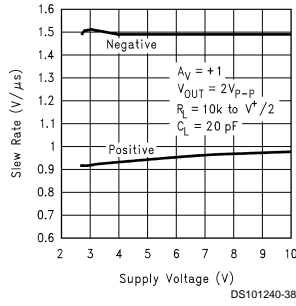

Slew Rate vs. Capacitive Load

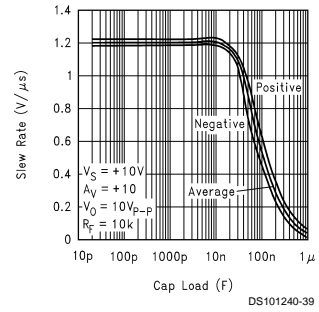

Slew Rate vs. Capacitive Load

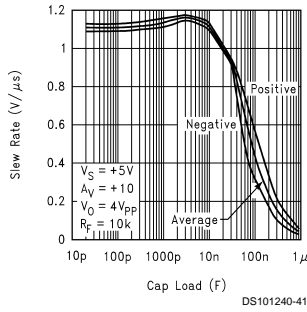

Slew Rate vs. Capacitive Load

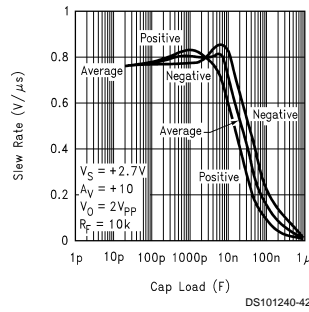

Slew Rate vs. Capacitive Load

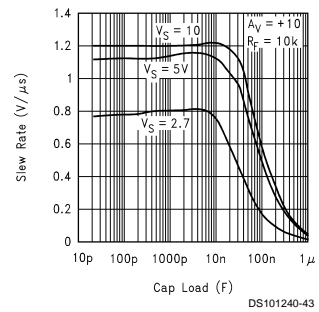

Voltage Noise vs. Frequency

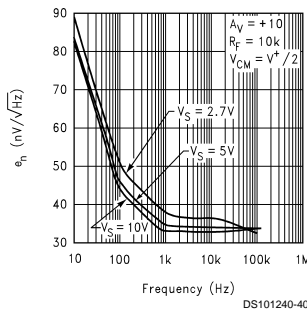

Voltage Noise vs. V_{CM} @ Various Frequencies

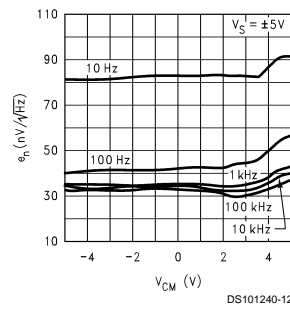

THD+N vs. Amplitude

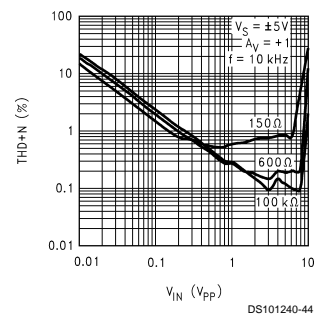

Typical Performance Characteristics $V_S = 2.7V$, Single Supply, $V_{CM} = V^+/2$, $T_A = 25^\circ C$ unless specified (Continued)

THD+N vs. Frequency

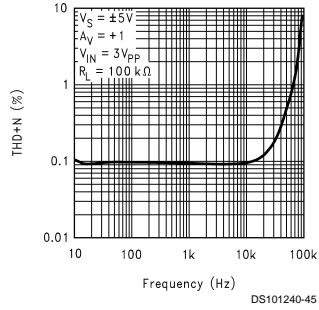

Sourcing Current vs. Output Voltage ($V_S = 2.7V$)

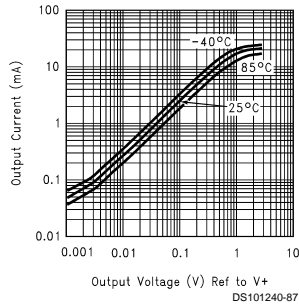

Sinking Current vs. Output Voltage ($V_S = 2.7V$)

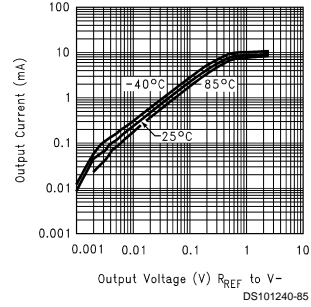

Sourcing Current vs. Output Voltage ($V_S = 10V$)

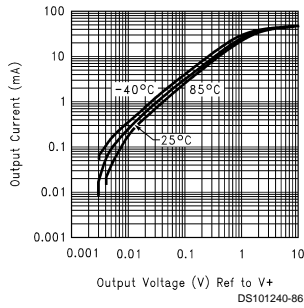

Sinking Current vs. Output Voltage ($V_S = 10V$)

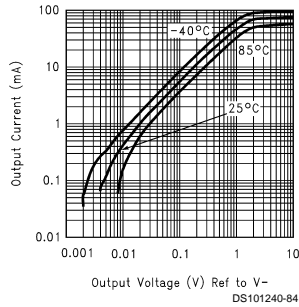

Cap Load vs. I_{OUT}

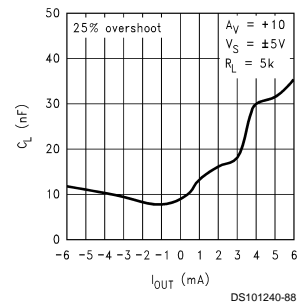

Cap Load vs. Isolation Resistance

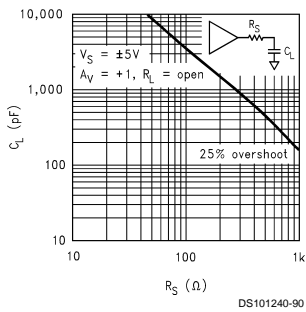

Physical Dimensions inches (millimeters) unless otherwise noted

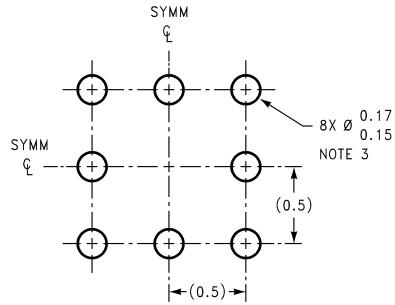

LAND PATTERN RECOMMENDATION

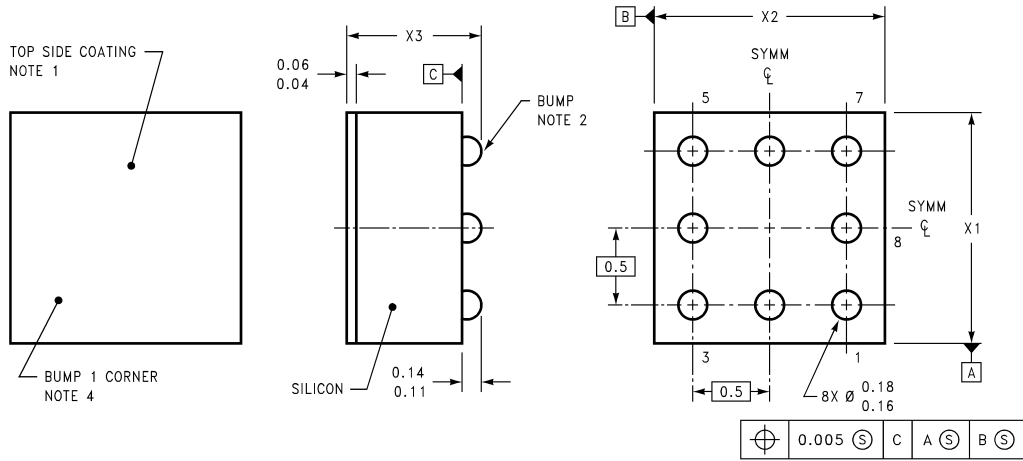

DIMENSIONS ARE IN MILLIMETERS

BPA08XXX (REV A)

NOTES: UNLESS OTHERWISE SPECIFIED

1. EPOXY COATING
2. 63Sn/37Pb EUTECTIC BUMP
3. RECOMMENDED NON-SOLDER MASK DEFINED LANDING PAD.
4. PIN 1 IS ESTABLISHED BY LOWER LEFT CORNER WITH RESPECT TO TEXT ORIENTATION. REMAINING PINS ARE NUMBERED COUNTERCLOCKWISE.
5. XXX IN DRAWING NUMBER REPRESENTS PACKAGE SIZE VARIATION WHERE X1 IS PACKAGE WIDTH, X2 IS PACKAGE LENGTH AND X3 IS PACKAGE HEIGHT.
6. REFERENCE JEDEC REGISTRATION MO-211, VARIATION BC.

micro SMD Package
Order Package Number LMC8101BP or LMC8101BPX
NS Package Number BPA08EFB
 $X_1 = 1.387$ $X_2 = 1.4127$ $X_3 = 0.850$

Physical Dimensions inches (millimeters) unless otherwise noted (Continued)

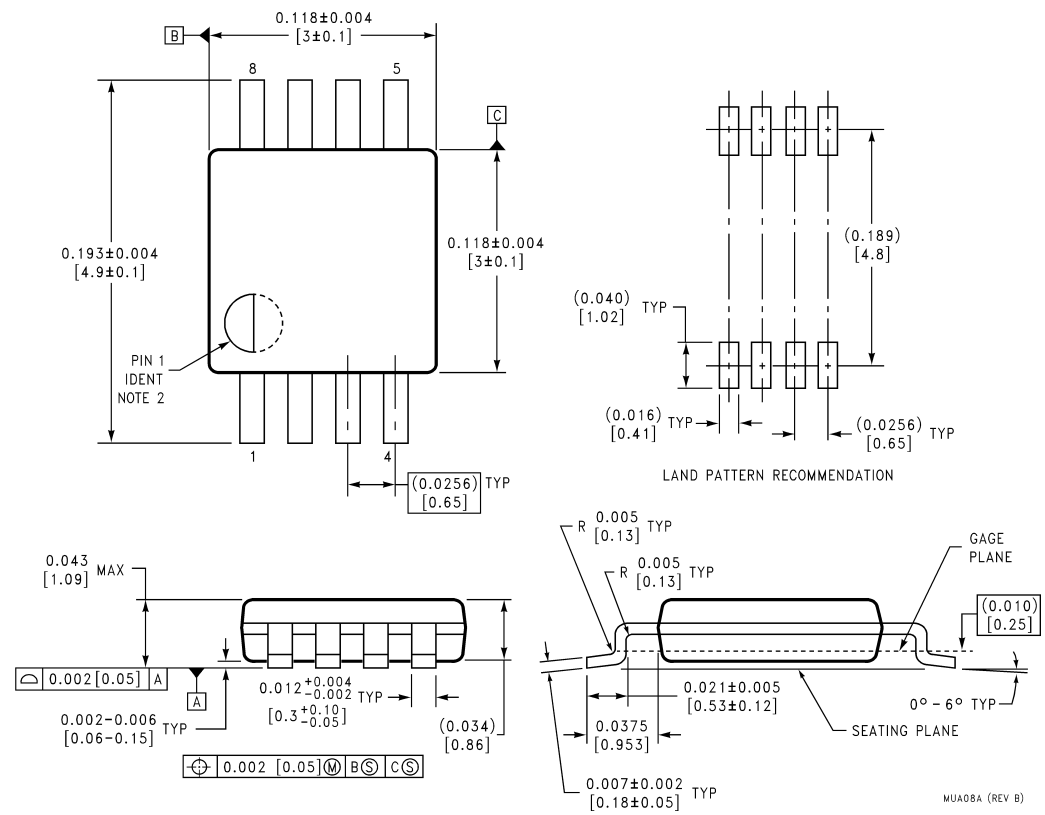

8-Pin MSOP Package
Order Package Number LMC8101MM or LMC8101MMX
NS Package Number MUA08A

LIFE SUPPORT POLICY

NATIONAL'S PRODUCTS ARE NOT AUTHORIZED FOR USE AS CRITICAL COMPONENTS IN LIFE SUPPORT DEVICES OR SYSTEMS WITHOUT THE EXPRESS WRITTEN APPROVAL OF THE PRESIDENT AND GENERAL COUNSEL OF NATIONAL SEMICONDUCTOR CORPORATION. As used herein:

1. Life support devices or systems are devices or systems which, (a) are intended for surgical implant into the body, or (b) support or sustain life, and whose failure to perform when properly used in accordance with instructions for use provided in the labeling, can be reasonably expected to result in a significant injury to the user.
2. A critical component is any component of a life support device or system whose failure to perform can be reasonably expected to cause the failure of the life support device or system, or to affect its safety or effectiveness.

 <p>National Semiconductor Corporation Americas Tel: 1-800-272-9959 Fax: 1-800-737-7018 Email: support@nsc.com www.national.com</p>	<p>National Semiconductor Europe Fax: +49 (0) 1 80-530 85 86 Email: europe.support@nsc.com Deutsch Tel: +49 (0) 1 80-530 85 85 English Tel: +49 (0) 1 80-532 78 32 Français Tel: +49 (0) 1 80-532 93 58 Italiano Tel: +49 (0) 1 80-534 16 80</p>	<p>National Semiconductor Asia Pacific Customer Response Group Tel: 65-2544466 Fax: 65-2504466 Email: sea.support@nsc.com</p>	<p>National Semiconductor Japan Ltd. Tel: 81-3-5639-7560 Fax: 81-3-5639-7507</p>
--	---	---	---

National does not assume any responsibility for use of any circuitry described, no circuit patent licenses are implied and National reserves the right at any time without notice to change said circuitry and specifications.