

4 PIN DIP PHOTOTRANSISTOR AC INPUT PHOTOCOUPLER

EL814 Series

Features:

- AC input response
- Current transfer ratio
(CTR: Min. 20% at $I_F = \pm 1\text{mA}$, $V_{CE} = 5\text{V}$)
- High isolation voltage between input and output ($V_{iso} = 5000\text{ V rms}$)
- Wide Operating temperature range
-55~110°C
- High collector-emitter voltage $V_{CEO} = 80\text{V}$
- Compact dual-in-line package
- Pb free and RoHS compliant.
- UL approved (No. E214129)
- VDE approved (No. 132249)
- SEMKO approved (No. 716108)
- NEMKO approved (No. P06206474)
- DEMKO approved (No. 313924)
- FIMKO approved (No. FI 22807)
- CSA approved (No. 1143601)

Description

The EL814 series of devices each consist of two infrared emitting diodes, connected in inverse parallel, optically coupled to a phototransistor detector.

They are packaged in a 4-pin DIP package and available in wide-lead spacing and SMD option.

Applications

- AC line monitor
- Programmable controllers
- Telephone line interface
- Unknown polarity DC sensor

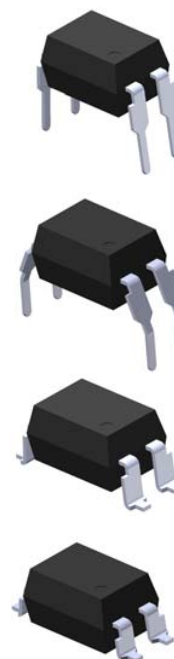

Schematic

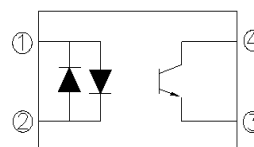

Pin Configuration

1. Anode / Cathode
2. Cathode / Anode
3. Emitter
4. Collector



LIGHTING FOREVER

4 PIN DIP PHOTOTRANSISTOR AC INPUT PHOTOCOUPLER

EL814 Series

Absolute Maximum Ratings ($T_a=25^{\circ}\text{C}$)

Parameter		Symbol	Rating	Unit
Input	Forward current	I_F	± 50	mA
	Peak forward current ($t = 10\mu\text{s}$)	I_{FM}	1	A
	Power dissipation	P_D	70	mW
	Derating factor (above 100°C)		2.9	mW/ $^{\circ}\text{C}$
Output	Power dissipation	P_C	150	mW
	Derating factor (above 100°C)		5.8	mW/ $^{\circ}\text{C}$
	Collector-Emitter voltage	V_{CEO}	80	V
	Emitter-Collector voltage	V_{ECO}	6	V
Total power dissipation		P_{tot}	200	mW
Isolation voltage ^{*1}		V_{iso}	5000	V rms
Operating temperature		T_{opr}	-55~+110	$^{\circ}\text{C}$
Storage temperature		T_{stg}	-55~+125	$^{\circ}\text{C}$
Soldering temperature ^{*2}		T_{sol}	260	$^{\circ}\text{C}$

Notes

*1 AC for 1 minute, R.H.= 40 ~ 60% R.H. In this test, pins 1 & 2 are shorted together, and pins 3 & 4 are shorted together.

*2 For 10 seconds.



LIGHTING FOREVER

4 PIN DIP PHOTOTRANSISTOR AC INPUT PHOTOCOUPLER

EL814 Series

Electrical Characteristics ($T_a=25^{\circ}\text{C}$ unless specified otherwise)

Input

Parameter	Symbol	Min.	Typ.*	Max.	Unit	Condition
Forward voltage	V_F	-	1.2	1.4	V	$I_F = \pm 20\text{mA}$
Input capacitance	C_{in}	-	50	250	pF	$V = 0, f = 1\text{KHz}$

Output

Parameter	Symbol	Min.	Typ.*	Max.	Unit	Condition
Collector-Emitter dark current	I_{CEO}	-	-	100	nA	$V_{CE} = 20\text{V}, I_F = 0\text{mA}$
Collector-Emitter breakdown voltage	BV_{CEO}	80	-	-	V	$I_C = 0.1\text{mA}$
Emitter-Collector breakdown voltage	BV_{ECO}	6	-	-	V	$I_E = 0.1\text{mA}$

Transfer Characteristics ($T_a=25^{\circ}\text{C}$ unless specified otherwise)

Parameter	Symbol	Min.	Typ.*	Max.	Unit	Condition
Current Transfer ratio	EL814	20	-	300	%	$I_F = \pm 1\text{mA}, V_{CE} = 5\text{V}$
	EL814A	50	-	150		
Collector-emitter saturation voltage	$V_{CE(sat)}$	-	0.05	0.2	V	$I_F = \pm 20\text{mA}, I_C = 1\text{mA}$
Isolation resistance	R_{IO}	5×10^{10}	10^{11}	-	Ω	$V_{IO} = 500\text{Vdc}, 40\sim 60\%R.H$
Cut-off frequency	f_c	-	80	-	kHz	$V_{CE}=5\text{V}, I_C=2\text{mA}, R_L=100\Omega, -3\text{dB}$
Floating capacitance	C_{IO}	-	0.6	1.0	pF	$V_{IO} = 0, f = 1\text{MHz}$
Rise time	T_r	-	7	18	μs	$V_{CE}=2\text{V}, I_C=2\text{mA}, R_L=100\Omega$
Fall time	T_f	-	11	18	μs	

* Typical values at $T_a = 25^{\circ}\text{C}$

4 PIN DIP PHOTOTRANSISTOR AC INPUT PHOTOCOUPLER

EL814 Series

Typical Performance Curves

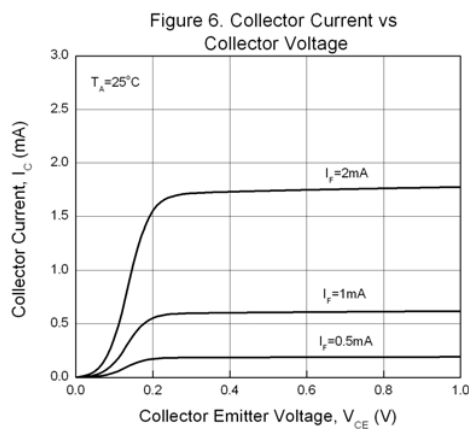
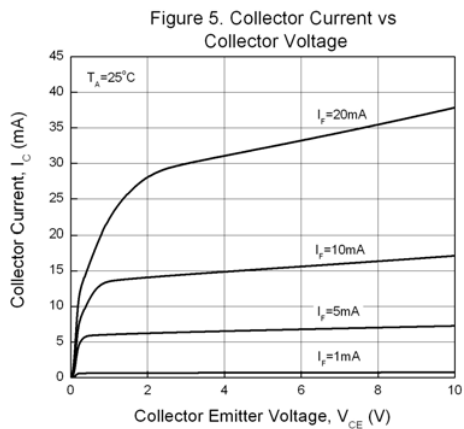
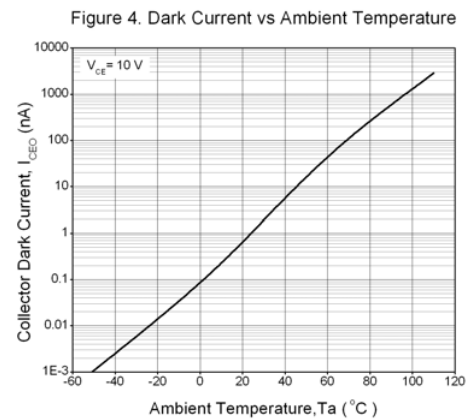
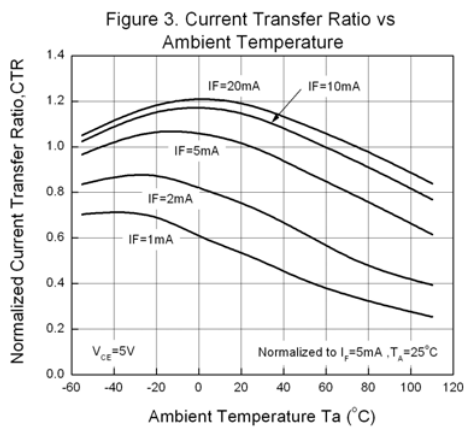
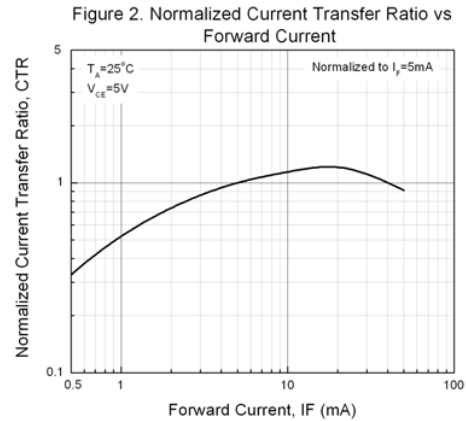
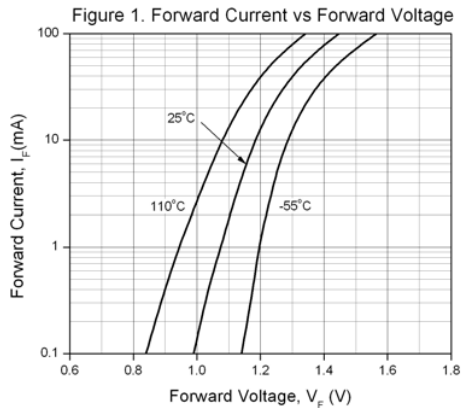

4 PIN DIP PHOTOTRANSISTOR AC INPUT PHOTOCOUPLER

EL814 Series

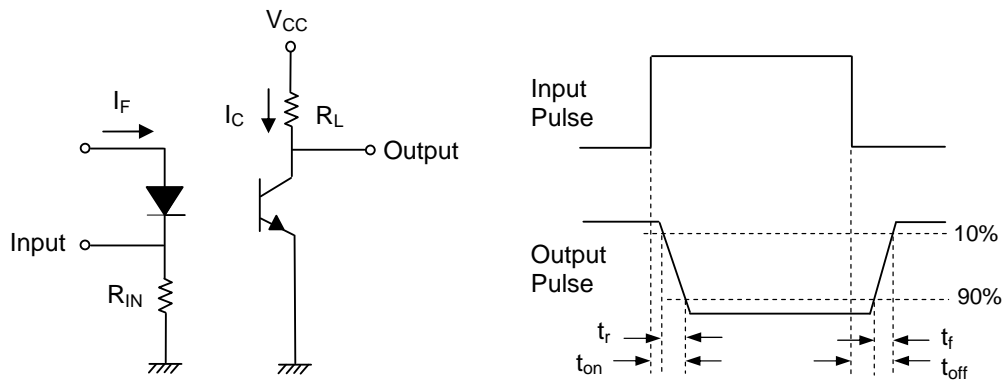
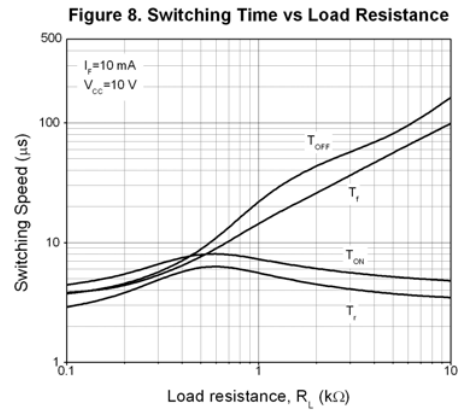
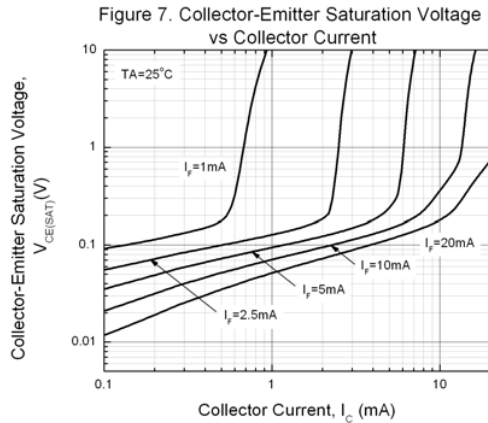

Figure 9. Switching Time Test Circuit & Waveforms



LIGHTING FOREVER

4 PIN DIP PHOTOTRANSISTOR AC INPUT PHOTOCOUPLER

EL814 Series

Order Information

Part Number

EL814X(Y)(Z)

Note

- X = Lead form option (S, S1, M or none)
- Y = CTR Rank option (A or none)
- Z = Tape and reel option (TA, TB, TU, TD or none).

Option	Description	Packing quantity
None	Standard DIP-4	100 units per tube
M	Wide lead bend (0.4 inch spacing)	100 units per tube
S (TA)	Surface mount lead form + TA tape & reel option	1000 units per reel
S (TB)	Surface mount lead form + TB tape & reel option	1000 units per reel
S1 (TA)	Surface mount lead form (low profile) + TA tape & reel option	1000 units per reel
S1 (TB)	Surface mount lead form (low profile) + TB tape & reel option	1000 units per reel
S (TU)	Surface mount lead form + TU tape & reel option	1500 units per reel
S (TD)	Surface mount lead form + TD tape & reel option	1500 units per reel
S1 (TU)	Surface mount lead form (low profile) + TU tape & reel option	1500 units per reel
S1 (TD)	Surface mount lead form (low profile) + TD tape & reel option	1500 units per reel

4 PIN DIP PHOTOTRANSISTOR AC INPUT PHOTOCOUPLER

EL814 Series

Package Drawings (Dimensions in mm)

Standard DIP Type

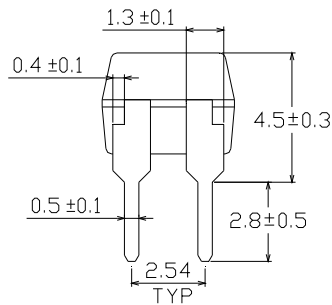
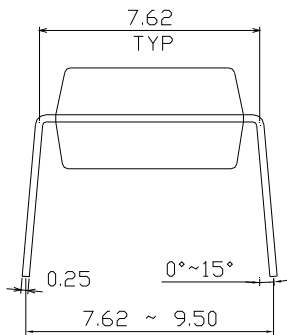
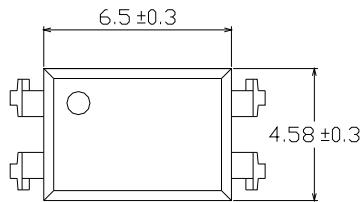

Option M Type

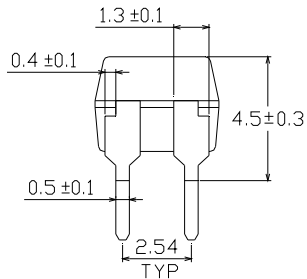
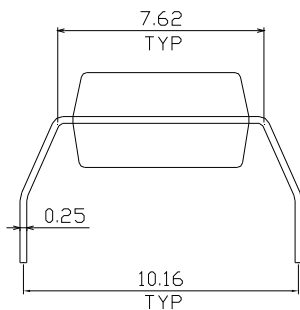
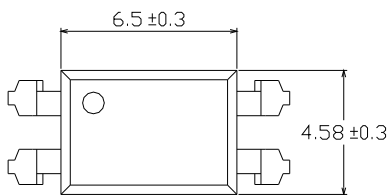

4 PIN DIP PHOTOTRANSISTOR AC INPUT PHOTOCOUPLER

EL814 Series

Option S Type

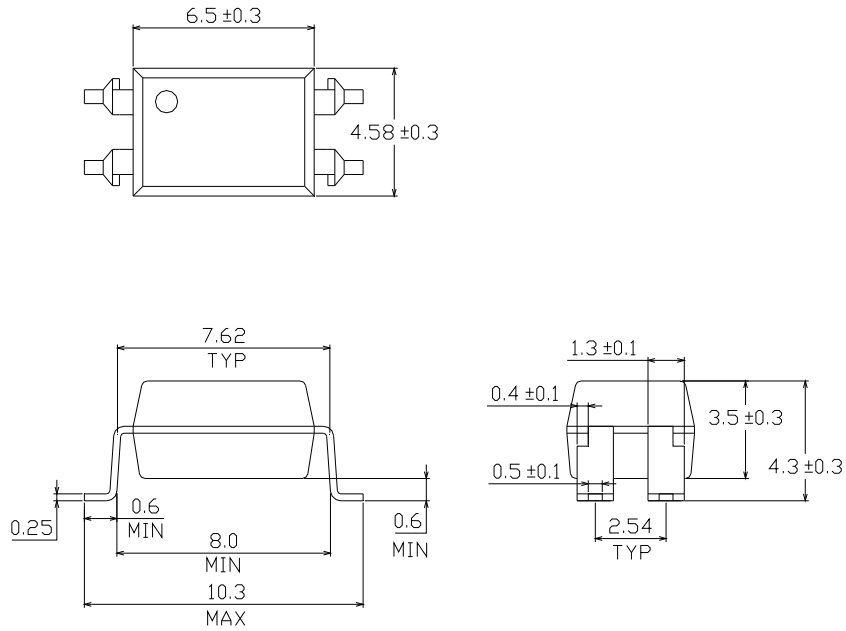

Option S1 Type

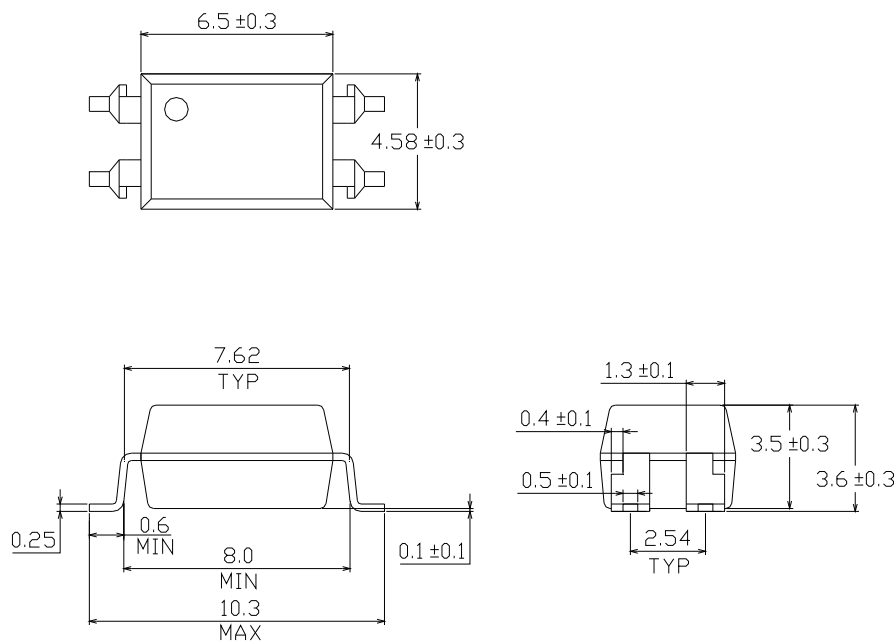



LIGHTING FOREVER

4 PIN DIP PHOTOTRANSISTOR AC INPUT PHOTOCOUPLER

EL814 Series

Recommended pad layout for surface mount leadform

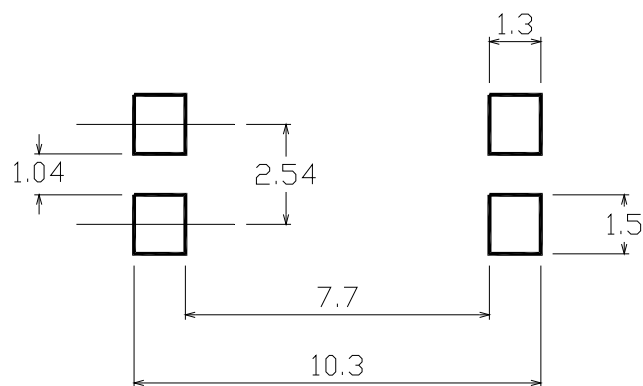

Device Marking



Notes

- EL814 denotes Device Number
- F denotes Factory Code (C: China, T: Taiwan)
- R denotes CTR Rank (A or none)
- Y denotes 1 digit Year code
- WW denotes 2 digit Week code

4 PIN DIP PHOTOTRANSISTOR AC INPUT PHOTOCOUPLER

EL814 Series

Tape & Reel Packing Specifications

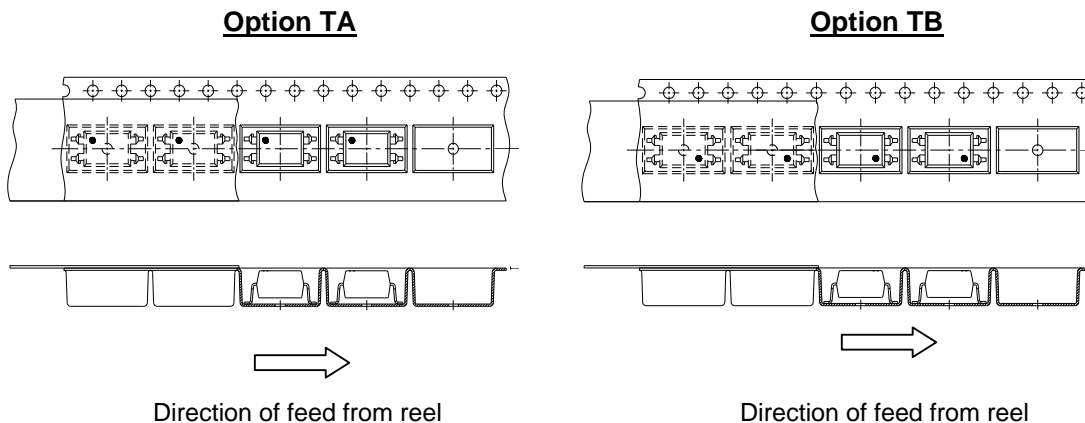

Tape dimensions

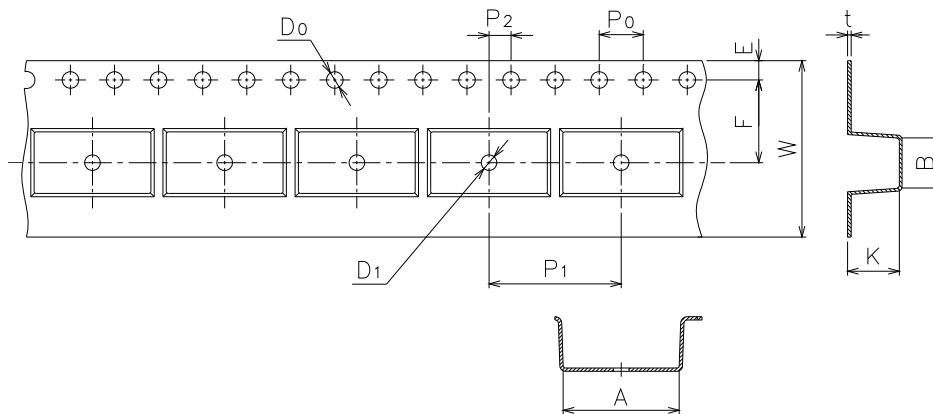

Dimension No.	A	B	Do	D1	E	F
Dimension(mm)	10.4±0.1	4.55±0.1	1.5±0.1	1.5±0.05	1.75±0.1	7.5±0.1
Dimension No.	Po	P1	P2	t	W	K
Dimension(mm)	4.0±0.1	12.0±0.1	2.0±0.1	0.33±0.1	16.0+0.3/ -0.1	4.55±0.1

4 PIN DIP PHOTOTRANSISTOR AC INPUT PHOTOCOUPLER

EL814 Series

Option TD

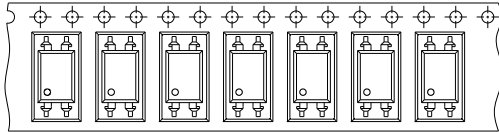

Option TU

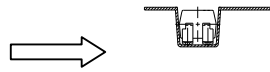
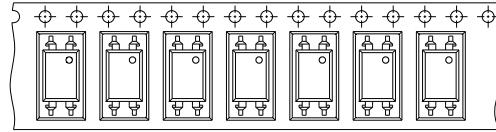

Direction of feed from reel



Direction of feed from reel

Tape dimensions

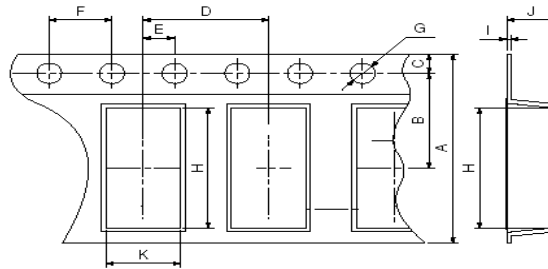

Dimension No.	A	B	C	D	E	F
Dimension(mm)	16.00±0.3	7.5±0.1	1.75±0.1	8.0±0.1	2.0±0.1	4.0±0.1
Dimension No.	G	H	I	J	K	
Dimension(mm)	1.5+0.1/-0	10.4±0.1	0.4±0.05	4.55±0.1	5.1±0.1	

4 PIN DIP PHOTOTRANSISTOR AC INPUT PHOTOCOUPLER

EL814 Series

Solder Reflow Temperature Profile

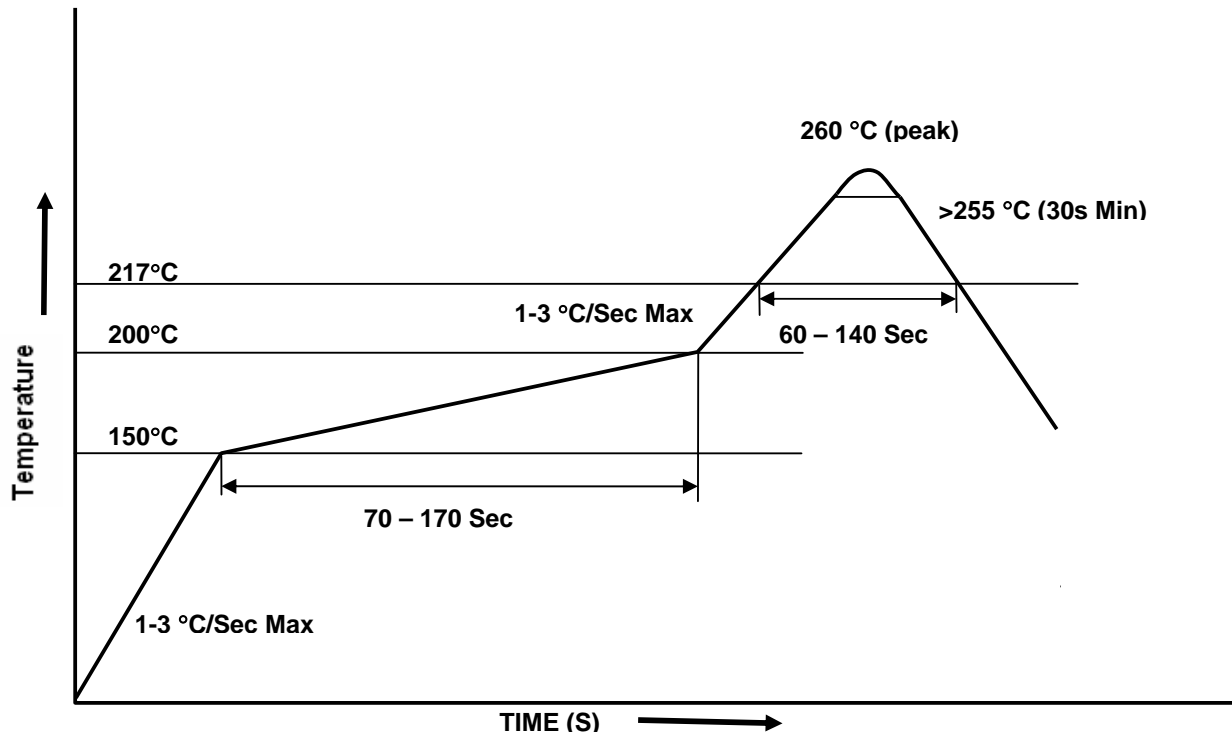



LIGHTING FOREVER

4 PIN DIP PHOTOTRANSISTOR AC INPUT PHOTOCOUPLER

EL814 Series

DISCLAIMER

1. The specifications in this datasheet may be changed without notice. EVERLIGHT reserves the authority on material change for above specification.
2. When using this product, please observe the absolute maximum ratings and the instructions for use as outlined in this datasheet. EVERLIGHT assumes no responsibility for any damage resulting from use of the product which does not comply with the absolute maximum ratings and the instructions included in this datasheet.
3. These specification sheets include materials protected under copyright of EVERLIGHT. Reproduction in any form is prohibited without the specific consent of EVERLIGHT.