

## 600MHz Current Feedback Amplifiers with Enable



The EL5164, EL5165, and EL5364 are current feedback amplifiers with a very high bandwidth of 600MHz. This

makes these amplifiers ideal for today's high speed video and monitor applications.

With a supply current of just 5mA and the ability to run from a single supply voltage from 5V to 12V, the amplifiers are also ideal for hand held, portable or battery-powered equipment.

The EL5164 also incorporates an enable and disable function to reduce the supply current to 100 $\mu$ A typical per amplifier. Allowing the CE pin to float or applying a low logic level will enable the amplifier.

The EL5165 is offered in the 5-pin SOT-23 package, EL5164 is available in the 6-pin SOT-23 and the industry-standard 8-pin SO packages, and the EL5364 in a 16-pin SO and 16-pin QSOP packages. All operate over the industrial temperature range of -40°C to +85°C.

## Ordering Information

PART NUMBER	PACKAGE	TAPE & REEL	PKG. DWG. #
EL5164IS	8-Pin SO	-	MDP0027
EL5164IS-T7	8-Pin SO	7"	MDP0027
EL5164IS-T13	8-Pin SO	13"	MDP0027
EL5164IW-T7	6-Pin SOT-23	7" (3K pcs)	MDP0038
EL5164IW-T7A	6-Pin SOT-23	7" (250 pcs)	MDP0038
EL5165IW-T7	5-Pin SOT-23	7" (3K pcs)	MDP0038
EL5165IW-T7A	5-Pin SOT-23	7" (250 pcs)	MDP0038
EL5165IC-T7	5-Pin SC-70	7" (3K pcs)	P5.049
EL5165IC-T7A	5-Pin SC-70	7" (250 pcs)	P5.049
EL5364IS	16-Pin SO (0.150")	-	MDP0027
EL5364IS-T7	16-Pin SO (0.150")	7"	MDP0027
EL5364IS-T13	16-Pin SO (0.150")	13"	MDP0027
EL5364IU	16-Pin QSOP	-	MDP0040
EL5364IU-T7	16-Pin QSOP	7"	MDP0040
EL5364IU-T13	16-Pin QSOP	13"	MDP0040
EL5364IUZ (See Note)	16-Pin QSOP (Pb-free)	-	MDP0040
EL5364IUZ-T7 (See Note)	16-Pin QSOP (Pb-free)	7"	MDP0040
EL5364IUZ-T13 (See Note)	16-Pin QSOP (Pb-free)	13"	MDP0040

NOTE: Intersil Pb-free products employ special Pb-free material sets; molding compounds/die attach materials and 100% matte tin plate termination finish, which is compatible with both SnPb and Pb-free soldering operations. Intersil Pb-free products are MSL classified at Pb-free peak reflow temperatures that meet or exceed the Pb-free requirements of IPC/JEDEC J Std-020B.

## Features

- 600MHz -3dB bandwidth
- 4700V/ $\mu$ s slew rate
- 5mA supply current
- Single and dual supply operation, from 5V to 12V supply span
- Fast enable/disable (EL5164 & EL5364 only)
- Available in SOT-23 packages
- Dual (EL5264 & EL5265) and triple (EL5362 & EL5363) also available
- High speed, 1GHz product available (EL5166 & EL5167)
- 300MHz product available (EL5162 family)
- Pb-free available

## Applications

- Video amplifiers
- Cable drivers
- RGB amplifiers
- Test equipment
- Instrumentation
- Current to voltage converters

Pinouts

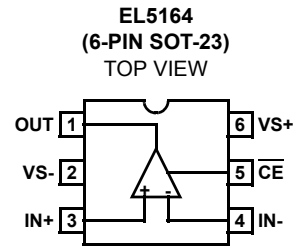
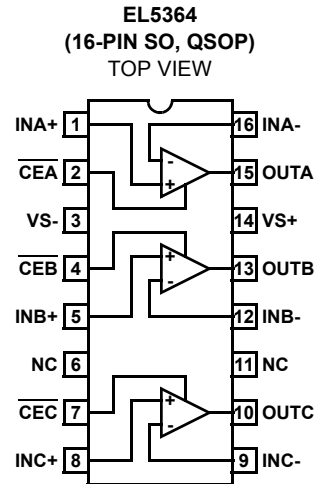
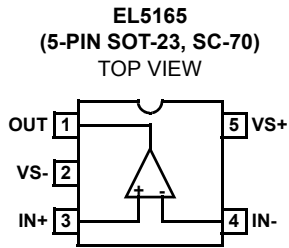
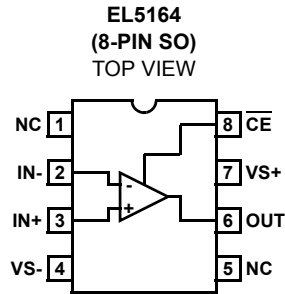

## EL5164, EL5165, EL5364

### Absolute Maximum Ratings ( $T_A = 25^\circ\text{C}$ )

Supply Voltage between $V_{S+}$ and $V_{S-}$ . . . . . 13.2V	Power Dissipation . . . . . See Curves
Maximum Continuous Output Current . . . . . 50mA	Storage Temperature . . . . . $-65^\circ\text{C}$ to $+150^\circ\text{C}$
Pin Voltages . . . . . $V_{S-} -0.5\text{V}$ to $V_{S+} +0.5\text{V}$	Ambient Operating Temperature . . . . . $-40^\circ\text{C}$ to $+85^\circ\text{C}$
Operating Junction Temperature . . . . . $125^\circ\text{C}$	

*CAUTION: Stresses above those listed in "Absolute Maximum Ratings" may cause permanent damage to the device. This is a stress only rating and operation of the device at these or any other conditions above those indicated in the operational sections of this specification is not implied.*

*IMPORTANT NOTE: All parameters having Min/Max specifications are guaranteed. Typical values are for information purposes only. Unless otherwise noted, all tests are at the specified temperature and are pulsed tests, therefore:  $T_J = T_C = T_A$*

**Electrical Specifications**  $V_{S+} = +5\text{V}$ ,  $V_{S-} = -5\text{V}$ ,  $R_F = 750\Omega$  for  $A_V = 1$ ,  $R_F = 375\Omega$  for  $A_V = 2$ ,  $R_L = 150\Omega$ ,  $V_{ENABLE} = V_{S+} - 1\text{V}$ ,  
 $T_A = 25^\circ\text{C}$  unless otherwise specified.

PARAMETER	DESCRIPTION	CONDITIONS	MIN	TYP	MAX	UNIT
<b>AC PERFORMANCE</b>						
BW	-3dB Bandwidth	$A_V = +1$ , $R_L = 500\Omega$ , $R_F = 510\Omega$		600		MHz
		$A_V = +2$ , $R_L = 150\Omega$ , $R_F = 412\Omega$		450		MHz
BW1	0.1dB Bandwidth	$A_V = +2$ , $R_L = 150\Omega$ , $R_F = 412\Omega$		50		MHz
SR	Slew Rate	$V_{OUT} = -3\text{V}$ to $+3\text{V}$ , $A_V = +2$ , $R_L = 100\Omega$ (EL5164, EL5165)	3500	4700	7000	V/ $\mu\text{s}$
		$V_{OUT} = -3\text{V}$ to $+3\text{V}$ , $A_V = +2$ , $R_L = 100\Omega$ (EL5364)	3000	4200	6000	V/ $\mu\text{s}$
$t_S$	0.1% Settling Time	$V_{OUT} = -2.5\text{V}$ to $+2.5\text{V}$ , $A_V = +2$ , $R_F = R_G = 1\text{k}\Omega$		15		ns
$e_N$	Input Voltage Noise	$f = 1\text{MHz}$		2.1		nV/ $\sqrt{\text{Hz}}$
$i_{N-}$	IN- Input Current Noise	$f = 1\text{MHz}$		13		pA/ $\sqrt{\text{Hz}}$
$i_{N+}$	IN+ Input Current Noise	$f = 1\text{MHz}$		13		pA/ $\sqrt{\text{Hz}}$
HD2		5MHz, 2.5V <sub>P-P</sub>		-81		dBc
HD3		5MHz, 2.5V <sub>P-P</sub>		-74		dBc
dG	Differential Gain Error (Note 1)	$A_V = +2$		0.01		%
dP	Differential Phase Error (Note 1)	$A_V = +2$		0.01		°
<b>DC PERFORMANCE</b>						
$V_{OS}$	Offset Voltage		-5	1.5	+5	mV
$T_C V_{OS}$	Input Offset Voltage Temperature Coefficient	Measured from $T_{MIN}$ to $T_{MAX}$		6		$\mu\text{V}/^\circ\text{C}$
$R_{OL}$	Transimpedance		1.1	3		M $\Omega$
<b>INPUT CHARACTERISTICS</b>						
CMIR	Common Mode Input Range	Guaranteed by CMRR test	$\pm 3$	$\pm 3.3$		V
CMRR	Common Mode Rejection Ratio	$V_{IN} = \pm 3\text{V}$	50	62	75	dB
-ICMR	- Input Current Common Mode Rejection		-1	0.1	+1	$\mu\text{A}/\text{V}$
+ $I_{IN}$	+ Input Current		-10	2	+10	$\mu\text{A}$
- $I_{IN}$	- Input Current		-10	2	+10	$\mu\text{A}$
$R_{IN}$	Input Resistance	+ Input	300	650	1200	k $\Omega$
$C_{IN}$	Input Capacitance			1		pF

**EL5164, EL5165, EL5364**

**Electrical Specifications**  $V_{S+} = +5V$ ,  $V_{S-} = -5V$ ,  $R_F = 750\Omega$  for  $A_V = 1$ ,  $R_F = 375\Omega$  for  $A_V = 2$ ,  $R_L = 150\Omega$ ,  $V_{ENABLE} = V_{S+} - 1V$ ,  
 $T_A = 25^\circ C$  unless otherwise specified. **(Continued)**

PARAMETER	DESCRIPTION	CONDITIONS	MIN	TYP	MAX	UNIT
<b>OUTPUT CHARACTERISTICS</b>						
$V_O$	Output Voltage Swing	$R_L = 150\Omega$ to GND	$\pm 3.6$	$\pm 3.8$	$\pm 4.0$	V
		$R_L = 1k\Omega$ to GND	$\pm 3.9$	$\pm 4.1$	$\pm 4.2$	V
$I_{OUT}$	Output Current	$R_L = 10\Omega$ to GND	100	140	190	mA
<b>SUPPLY</b>						
$I_{SON}$	Supply Current - Enabled	No load, $V_{IN} = 0V$	3.2	3.5	4.2	mA
$I_{SOFF+}$	Supply Current - Disabled, per Amplifier		0		+75	$\mu A$
$I_{SOFF-}$	Supply Current - Disabled, per Amplifier	No load, $V_{IN} = 0V$	-75	-14	0	$\mu A$
PSRR	Power Supply Rejection Ratio	DC, $V_S = \pm 4.75V$ to $\pm 5.25V$	65	79		dB
-IPSR	- Input Current Power Supply Rejection	DC, $V_S = \pm 4.75V$ to $\pm 5.25V$	-1	0.1	+1	$\mu A/V$
<b>ENABLE (EL5164 ONLY)</b>						
$t_{EN}$	Enable Time			200		ns
$t_{DIS}$	Disable Time			800		ns
$I_{IHCE}$	$\overline{CE}$ Pin Input High Current	$\overline{CE} = V_{S+}$	1	10	+25	$\mu A$
$I_{ILCE}$	$\overline{CE}$ Pin Input Low Current	$\overline{CE} = (V_{S+}) - 5V$	-1	0	+1	$\mu A$
$V_{IHCE}$	$\overline{CE}$ Input High Voltage for Power-down		$V_{S+} - 1$			V
$V_{ILCE}$	$\overline{CE}$ Input Low Voltage for Power-down				$V_{S+} - 3$	V

NOTE:

- Standard NTSC test, AC signal amplitude = 286mV<sub>p-p</sub>, f = 3.58MHz

Typical Performance Curves

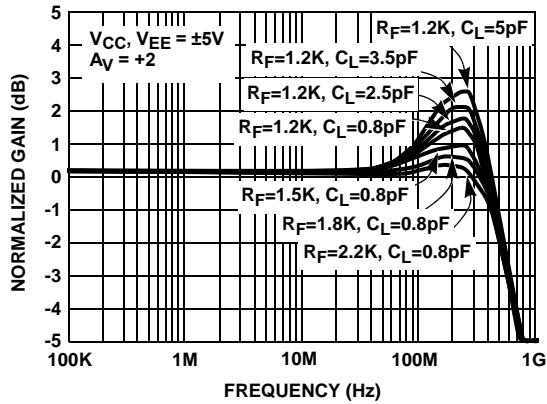

FIGURE 1. FREQUENCY RESPONSE FOR VARIOUS  $R_F$  AND  $C_L$

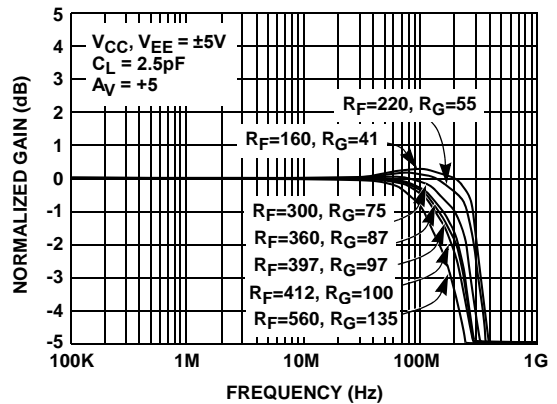

FIGURE 2. FREQUENCY RESPONSE FOR VARIOUS  $R_F$

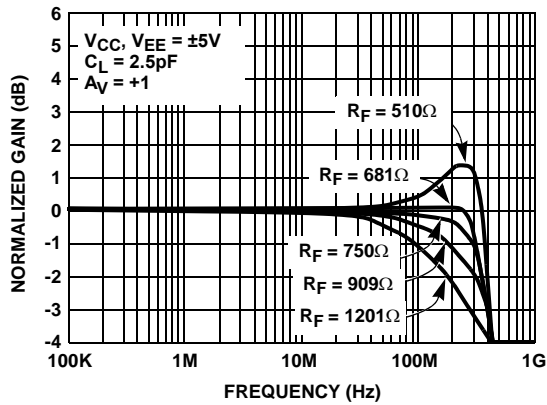

FIGURE 3. FREQUENCY RESPONSE FOR VARIOUS  $R_F$

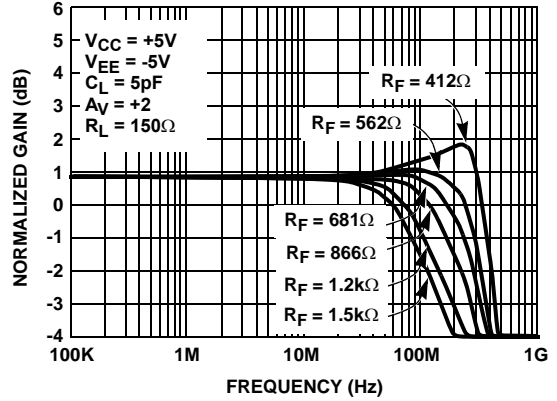

FIGURE 4. FREQUENCY RESPONSE FOR VARIOUS  $R_F$

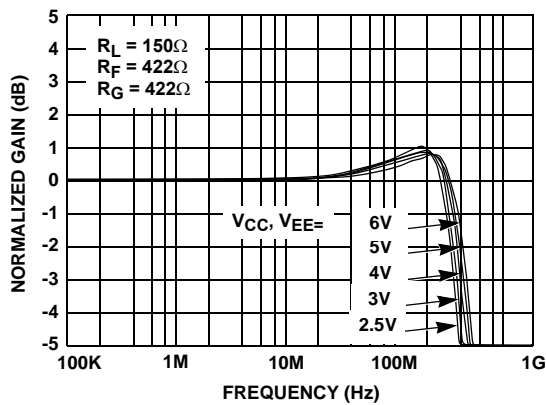

FIGURE 5. FREQUENCY RESPONSE FOR VARIOUS POWER SUPPLY VOLTAGES

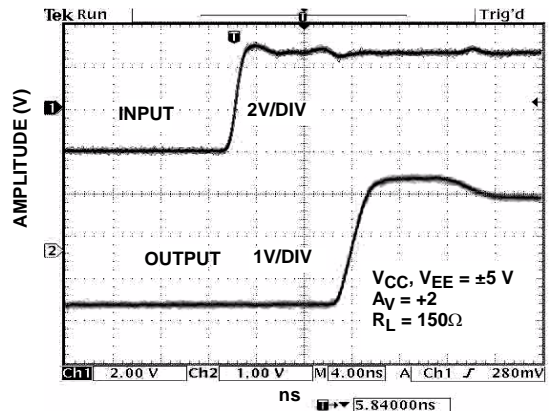

FIGURE 6. RISE TIME (ns)

Typical Performance Curves (Continued)

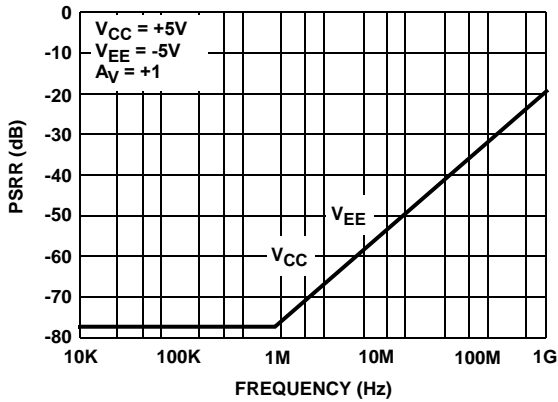

FIGURE 7. PSRR

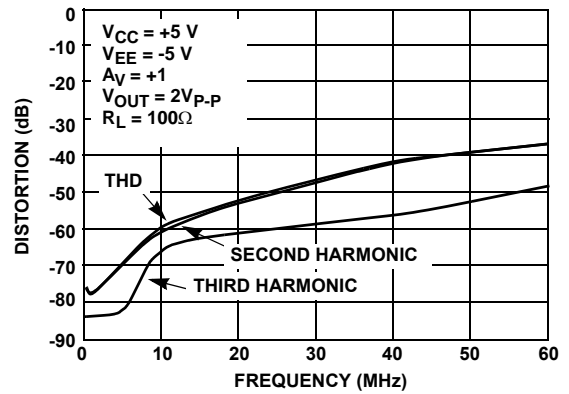

FIGURE 8. DISTORTION vs FREQUENCY ( $A_V = +1$ )

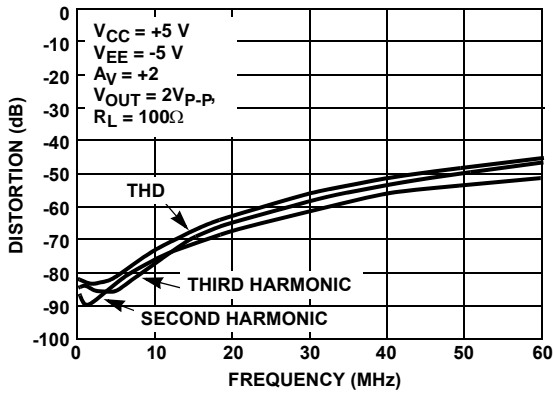

FIGURE 9. DISTORTION vs FREQUENCY ( $A_V = +2$ )

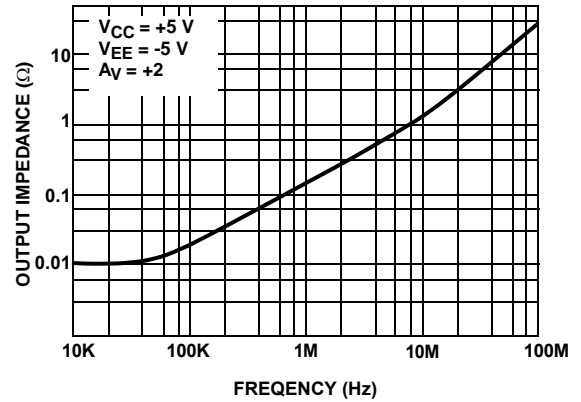

FIGURE 10. OUTPUT IMPEDANCE

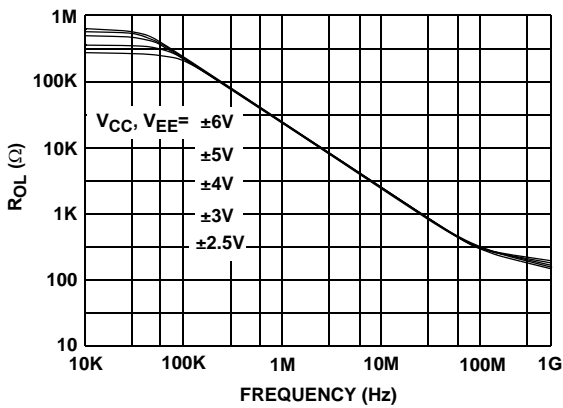

FIGURE 11.  $R_{OL}$  FOR VARIOUS  $V_{CC}, V_{EE}$

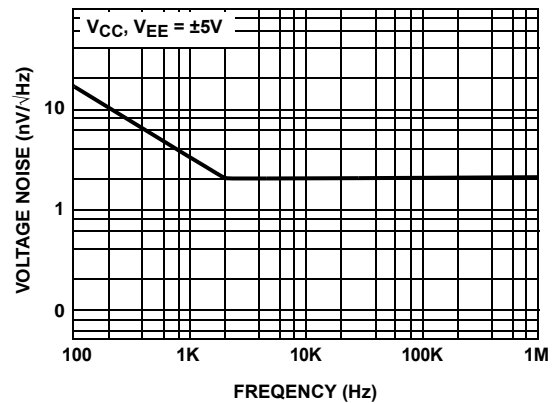

FIGURE 12. VOLTAGE NOISE

Typical Performance Curves (Continued)

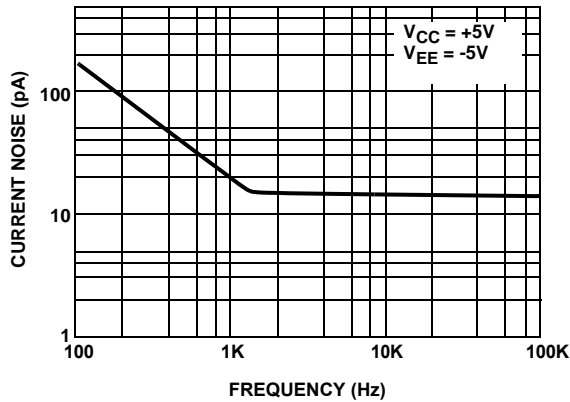

FIGURE 13. CURRENT NOISE

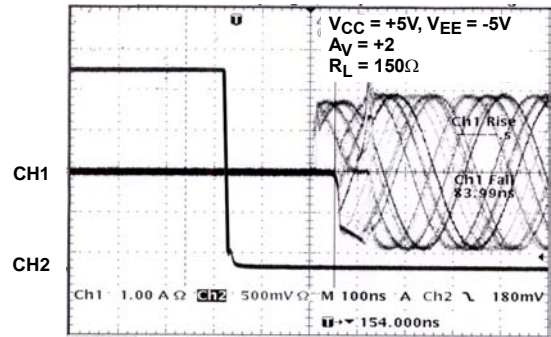

FIGURE 14. TURN ON DELAY

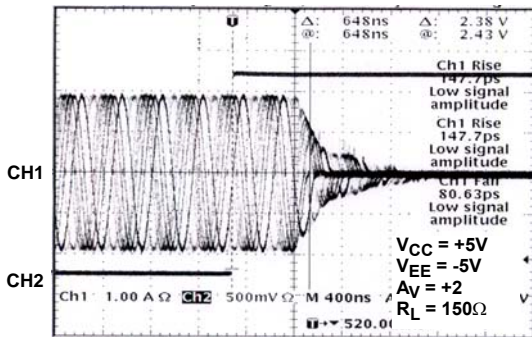

FIGURE 15. TURN OFF DELAY

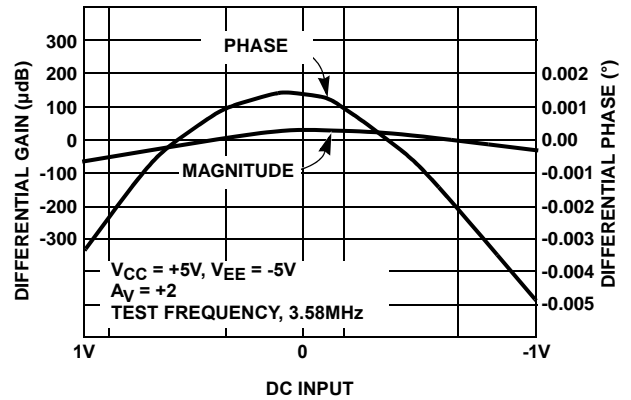

FIGURE 16. DIFFERENTIAL GAIN/PHASE vs DC INPUT VOLTAGE AT 3.58MHz

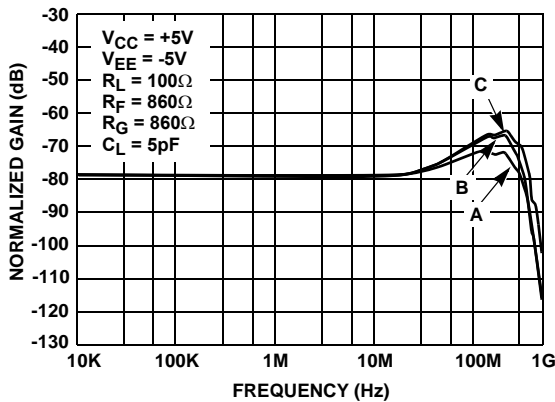

FIGURE 17. FREQUENCY RESPONSE FOR VARIOUS CHANNELS

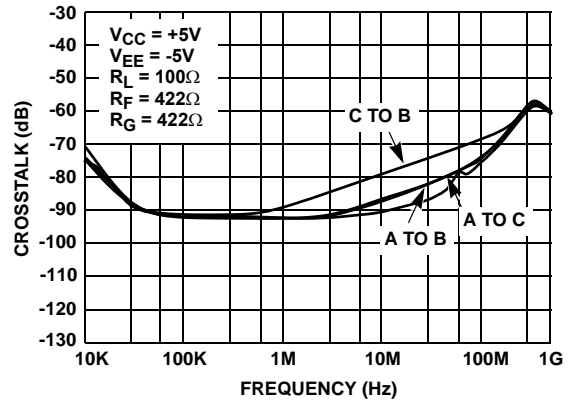

FIGURE 18. CHANNEL CROSSTALK BETWEEN CHANNELS

Typical Performance Curves (Continued)

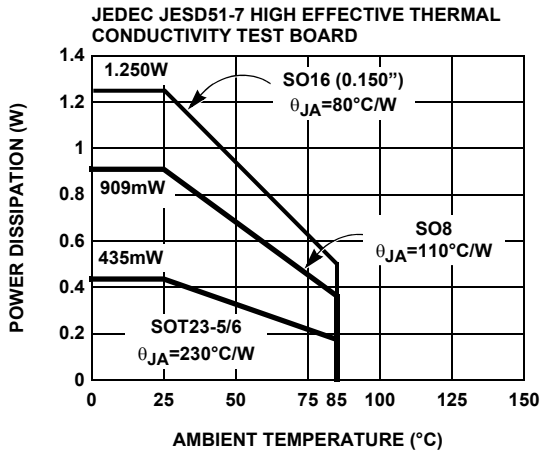

FIGURE 19. PACKAGE POWER DISSIPATION vs AMBIENT TEMPERATURE

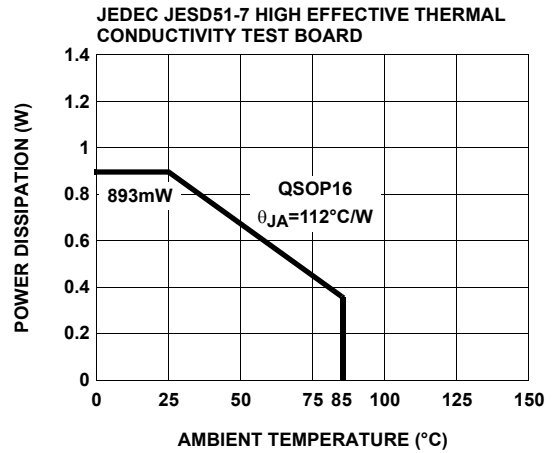

FIGURE 20. PACKAGE POWER DISSIPATION vs AMBIENT TEMPERATURE

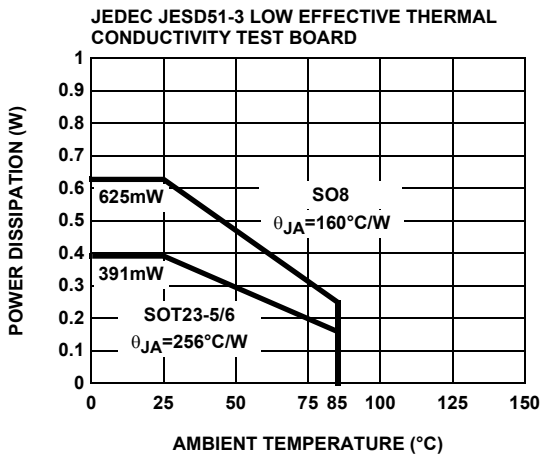

FIGURE 21. PACKAGE POWER DISSIPATION vs AMBIENT TEMPERATURE

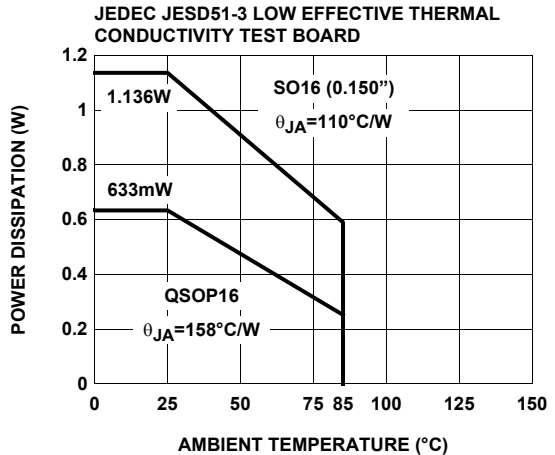

FIGURE 22. PACKAGE POWER DISSIPATION vs AMBIENT TEMPERATURE



**Pin Descriptions**

EL5164 (8-PIN SO)	EL5164 (6-PIN SOT-23)	EL5165 (5-PIN SOT-23)	PIN NAME	FUNCTION	EQUIVALENT CIRCUIT
1, 5			NC	Not connected	
2	4	4	IN-	Inverting input	<p>Circuit 1</p>
3	3	3	IN+	Non-inverting input	(See circuit 1)
4	2	2	VS-	Negative supply	
6	1	1	OUT	Output	<p>Circuit 2</p>
7	6	5	VS+	Positive supply	
8	5		$\overline{\text{CE}}$	Chip enable, allowing the pin to float or applying a low logic level will enable the amplifier.	<p>Circuit 3</p>

**Applications Information**

**Product Description**

The EL5164, EL5165, and EL5364 are current-feedback operational amplifiers that offers a wide -3dB bandwidth of 600MHz and a low supply current of 5mA per amplifier. The EL5164, EL5165, and EL5364 work with supply voltages ranging from a single 5V to 10V and they are also capable of swinging to within 1V of either supply on the output. Because of their current-feedback topology, the EL5164, EL5165, and EL5364 do not have the normal gain-bandwidth product associated with voltage-feedback operational amplifiers. Instead, its -3dB bandwidth to remain relatively constant as closed-loop gain is increased. This combination of high bandwidth and low power, together with aggressive pricing make the EL5164, EL5165, and EL5364 ideal choices for many low-power/high-bandwidth applications such as portable, handheld, or battery-powered equipment.

For varying bandwidth needs, consider the EL5166 and EL5167 with 1GHz on a 8.5mA supply current or the EL5162 and EL5163 with 300MHz on a 8.5mA supply current.

Versions include single, dual, and triple amp packages with 5-pin SOT-23, 16-pin QSOP, and 8-pin or 16-pin SO outlines.

**Power Supply Bypassing and Printed Circuit Board Layout**

As with any high frequency device, good printed circuit board layout is necessary for optimum performance. Low impedance ground plane construction is essential. Surface mount components are recommended, but if leaded components are used, lead lengths should be as short as possible. The power supply pins must be well bypassed to reduce the risk of oscillation. The combination of a 4.7µF tantalum capacitor in parallel with a 0.01µF capacitor has been shown to work well when placed at each supply pin.

For good AC performance, parasitic capacitance should be kept to a minimum, especially at the inverting input. (See the Capacitance at the Inverting Input section.) Even when ground plane construction is used, it should be removed from the area near the inverting input to minimize any stray capacitance at that node. Carbon or Metal-Film resistors are

acceptable with the Metal-Film resistors giving slightly less peaking and bandwidth because of additional series inductance. Use of sockets, particularly for the SO package, should be avoided if possible. Sockets add parasitic inductance and capacitance which will result in additional peaking and overshoot.

### **Disable/Power-Down**

The EL5164 amplifier can be disabled placing its output in a high impedance state. When disabled, the amplifier supply current is reduced to  $< 150\mu\text{A}$ . The EL5164 is disabled when its  $\overline{\text{CE}}$  pin is pulled up to within 1V of the positive supply. Similarly, the amplifier is enabled by floating or pulling its  $\overline{\text{CE}}$  pin to at least 3V below the positive supply. For  $\pm 5\text{V}$  supply, this means that an EL5164 amplifier will be enabled when  $\overline{\text{CE}}$  is 2V or less, and disabled when  $\overline{\text{CE}}$  is above 4V. Although the logic levels are not standard TTL, this choice of logic voltages allows the EL5164 to be enabled by tying  $\overline{\text{CE}}$  to ground, even in 5V single supply applications. The  $\overline{\text{CE}}$  pin can be driven from CMOS outputs.

### **Capacitance at the Inverting Input**

Any manufacturer's high-speed voltage- or current-feedback amplifier can be affected by stray capacitance at the inverting input. For inverting gains, this parasitic capacitance has little effect because the inverting input is a virtual ground, but for non-inverting gains, this capacitance (in conjunction with the feedback and gain resistors) creates a pole in the feedback path of the amplifier. This pole, if low enough in frequency, has the same destabilizing effect as a zero in the forward open-loop response. The use of large-value feedback and gain resistors exacerbates the problem by further lowering the pole frequency (increasing the possibility of oscillation.)

The EL5164, EL5165, and EL5364 have been optimized with a  $\text{TBD}\Omega$  feedback resistor. With the high bandwidth of these amplifiers, these resistor values might cause stability problems when combined with parasitic capacitance, thus ground plane is not recommended around the inverting input pin of the amplifier.

### **Feedback Resistor Values**

The EL5164, EL5165, and EL5364 have been designed and specified at a gain of +2 with  $R_F$  approximately  $412\Omega$ . This value of feedback resistor gives 300MHz of -3dB bandwidth at  $A_V = 2$  with 2dB of peaking. With  $A_V = -2$ , an  $R_F$  of  $300\Omega$  gives 275MHz of bandwidth with 1dB of peaking. Since the EL5164, EL5165, and EL5364 are current-feedback amplifiers, it is also possible to change the value of  $R_F$  to get more bandwidth. As seen in the curve of Frequency Response for Various  $R_F$  and  $R_G$ , bandwidth and peaking can be easily modified by varying the value of the feedback resistor.

Because the EL5164, EL5165, and EL5364 are current-feedback amplifiers, their gain-bandwidth product is not a constant for different closed-loop gains. This feature actually

allows the EL5164, EL5165, and EL5364 to maintain about the same -3dB bandwidth. As gain is increased, bandwidth decreases slightly while stability increases. Since the loop stability is improving with higher closed-loop gains, it becomes possible to reduce the value of  $R_F$  below the specified  $\text{TBD}\Omega$  and still retain stability, resulting in only a slight loss of bandwidth with increased closed-loop gain.

### **Supply Voltage Range and Single-Supply Operation**

The EL5164, EL5165, and EL5364 have been designed to operate with supply voltages having a span of greater than 5V and less than 10V. In practical terms, this means that they will operate on dual supplies ranging from  $\pm 2.5\text{V}$  to  $\pm 5\text{V}$ . With single-supply, the EL5164, EL5165, and EL5364 will operate from 5V to 10V.

As supply voltages continue to decrease, it becomes necessary to provide input and output voltage ranges that can get as close as possible to the supply voltages. The EL5164, EL5165, and EL5364 have an input range which extends to within 2V of either supply. So, for example, on  $\pm 5\text{V}$  supplies, the EL5164, EL5165, and EL5364 have an input range which spans  $\pm 3\text{V}$ . The output range of the EL5164, EL5165, and EL5364 is also quite large, extending to within 1V of the supply rail. On a  $\pm 5\text{V}$  supply, the output is therefore capable of swinging from -4V to +4V. Single-supply output range is larger because of the increased negative swing due to the external pull-down resistor to ground.

### **Video Performance**

For good video performance, an amplifier is required to maintain the same output impedance and the same frequency response as DC levels are changed at the output. This is especially difficult when driving a standard video load of  $150\Omega$ , because of the change in output current with DC level. Previously, good differential gain could only be achieved by running high idle currents through the output transistors (to reduce variations in output impedance.) These currents were typically comparable to the entire 5.5mA supply current of each EL5164, EL5165, and EL5364 amplifiers. Special circuitry has been incorporated in the EL5164, EL5165, and EL5364 to reduce the variation of output impedance with current output. This results in dG and dP specifications of  $\text{TBD}\%$  and  $\text{TBD}^\circ$ , while driving  $150\Omega$  at a gain of 2.

Video performance has also been measured with a  $500\Omega$  load at a gain of +1. Under these conditions, the EL5164, EL5165, and EL5364 have dG and dP specifications of 0.01% and  $0.01^\circ$ , respectively.

### **Output Drive Capability**

In spite of their low 5.5mA of supply current, the EL5164, EL5165, and EL5364 are capable of providing a minimum of  $\pm 75\text{mA}$  of output current. With a minimum of  $\pm 75\text{mA}$  of output drive, the EL5164, EL5165, and EL5364 are capable of driving  $50\Omega$  loads to both rails, making it an excellent

choice for driving isolation transformers in telecommunications applications.

**Driving Cables and Capacitive Loads**

When used as a cable driver, double termination is always recommended for reflection-free performance. For those applications, the back-termination series resistor will decouple the EL5164, EL5165, and EL5364 from the cable and allow extensive capacitive drive. However, other applications may have high capacitive loads without a back-termination resistor. In these applications, a small series resistor (usually between 5Ω and 50Ω) can be placed in series with the output to eliminate most peaking. The gain resistor (R<sub>G</sub>) can then be chosen to make up for any gain loss which may be created by this additional resistor at the output. In many cases it is also possible to simply increase the value of the feedback resistor (R<sub>F</sub>) to reduce the peaking.

**Current Limiting**

The EL5164, EL5165, and EL5364 have no internal current-limiting circuitry. If the output is shorted, it is possible to exceed the Absolute Maximum Rating for output current or power dissipation, potentially resulting in the destruction of the device.

**Power Dissipation**

With the high output drive capability of the EL5164, EL5165, and EL5364, it is possible to exceed the 125°C Absolute Maximum junction temperature under certain very high load current conditions. Generally speaking when R<sub>L</sub> falls below about 25Ω, it is important to calculate the maximum junction temperature (T<sub>JMAX</sub>) for the application to determine if power supply voltages, load conditions, or package type need to be modified for the EL5164, EL5165, and EL5364 to remain in the safe operating area. These parameters are calculated as follows:

$$T_{JMAX} = T_{MAX} + (\theta_{JA} \times n \times PD_{MAX})$$

where:

- T<sub>MAX</sub> = Maximum ambient temperature
- θ<sub>JA</sub> = Thermal resistance of the package
- n = Number of amplifiers in the package
- PD<sub>MAX</sub> = Maximum power dissipation of each amplifier in the package

PD<sub>MAX</sub> for each amplifier can be calculated as follows:

$$PD_{MAX} = (2 \times V_S \times I_{SMAX}) + \left[ (V_S - V_{OUTMAX}) \times \frac{V_{OUTMAX}}{R_L} \right]$$

where:

- V<sub>S</sub> = Supply voltage
- I<sub>SMAX</sub> = Maximum supply current of 1A
- V<sub>OUTMAX</sub> = Maximum output voltage (required)
- R<sub>L</sub> = Load resistance

**Typical Application Circuits**

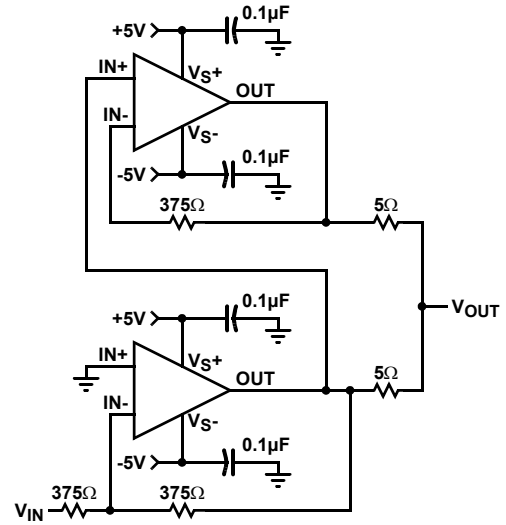

FIGURE 23. INVERTING 200mA OUTPUT CURRENT DISTRIBUTION AMPLIFIER

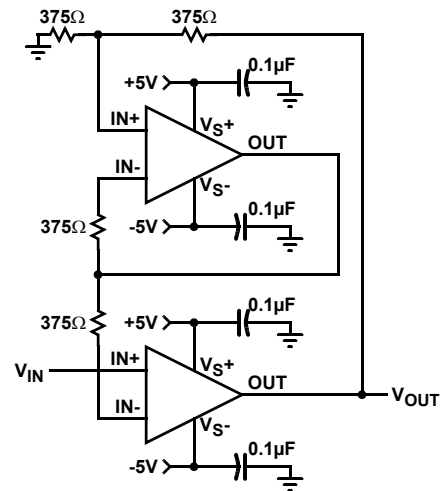

FIGURE 24. FAST-SETTLING PRECISION AMPLIFIER

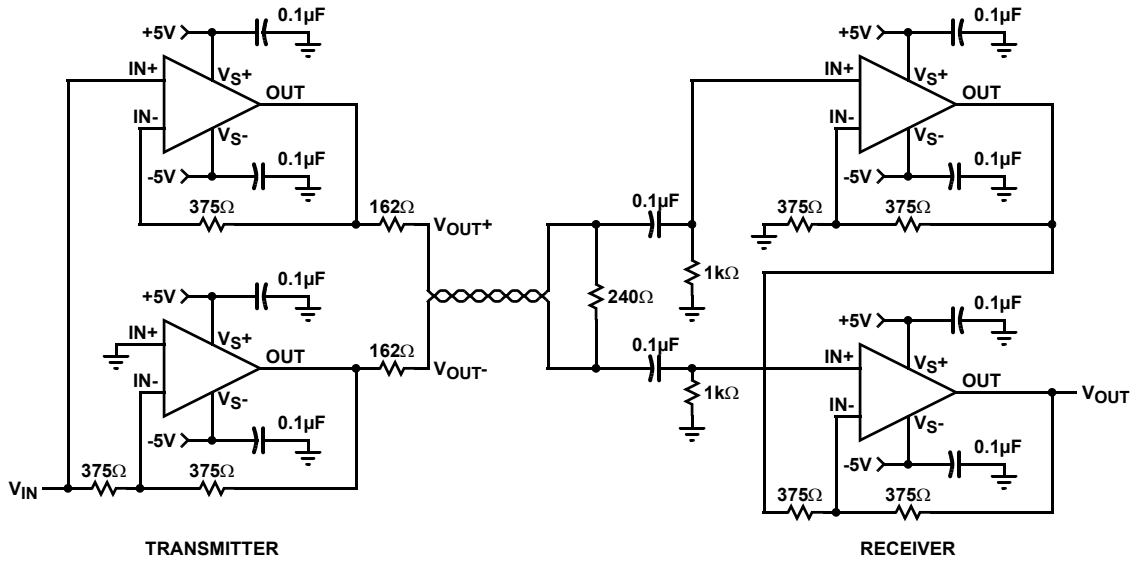

FIGURE 25. DIFFERENTIAL LINE DRIVER/RECEIVER

All Intersil U.S. products are manufactured, assembled and tested utilizing ISO9000 quality systems.  
Intersil Corporation's quality certifications can be viewed at [www.intersil.com/design/quality](http://www.intersil.com/design/quality)

*Intersil products are sold by description only. Intersil Corporation reserves the right to make changes in circuit design, software and/or specifications at any time without notice. Accordingly, the reader is cautioned to verify that data sheets are current before placing orders. Information furnished by Intersil is believed to be accurate and reliable. However, no responsibility is assumed by Intersil or its subsidiaries for its use; nor for any infringements of patents or other rights of third parties which may result from its use. No license is granted by implication or otherwise under any patent or patent rights of Intersil or its subsidiaries.*

For information regarding Intersil Corporation and its products, see [www.intersil.com](http://www.intersil.com)