

The RF Line VHF Power Amplifiers

... designed for 7.5 volt VHF power amplifier applications in industrial and commercial equipment primarily hand portable radios.

- MHW607-1: 136–150 MHz
- MHW607-2: 146–174 MHz
- MHW607-3: 174–195 MHz
- MHW607-4: 184–210 MHz
- Specified 7.5 Volt Characteristics:
 - RF Input Power = 1.0 mW (0 dBm)
 - RF Output Power = 7.0 Watts (MHW607-1,-2); 6.5 W (MHW607-3,-4)
 - Minimum Gain ($V_{Control} = 7.0 V$) = 38.5 dB
 - Harmonics = -40 dBc Max @ 2.0 f_o
- 50 Ω Input/Output Impedance
- Guaranteed Stability and Ruggedness
- Epoxy Glass PCB Construction Gives Consistent Performance and Reliability
- Circuit board photomaster available upon request by contacting RF Tactical Marketing in Phoenix, AZ.

MHW607-1
MHW607-2
MHW607-3
MHW607-4

7.0 W — 136 to 210 MHz
6.5 W — 174 to 210 MHz
VHF POWER
AMPLIFIERS

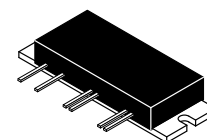

CASE 301K-02, STYLE 3

MAXIMUM RATINGS (Flange Temperature = 25°C)

Rating	Symbol	Value	Unit
DC Supply Voltage (Pins 2, 4, 5)	$V_{S1,2,3}$	9.0	Vdc
DC Control Voltage (Pin 3)	V_{Cont}	9.0	Vdc
RF Input Power	P_{in}	5.0	mW
RF Output Power ($V_{S1} = V_{S2} = V_{S3} = 9.0 V$)	P_{out}	10	W
Operating Case Temperature Range	T_C	-30 to +100	°C
Storage Temperature Range	T_{stg}	-30 to +100	°C

ELECTRICAL CHARACTERISTICS ($V_{S1} = V_{S2} = V_{S3} = 7.5 Vdc$, (Pins 2, 4, 5), $T_C = 25^\circ C$, 50 Ω System)

Characteristic	Symbol	Min	Max	Unit
Frequency Range MHW607-1 MHW607-2 MHW607-3 MHW607-4	—	136 146 174 184	150 174 195 210	MHz
Control Voltage ($P_{out} = 7.0 W$, $P_{in} = 1.0 mW$)(1)	V_{Cont}	0	7.0	Vdc
Quiescent Current ($V_{S1} = V_{S2} = V_{S3} = 7.5 Vdc$, $V_{Cont} = 7.0 Vdc$)	$I_{S1(q)} + I_{S2(q)}$	—	160	mA
Power Gain ($P_{out} = 7.0 W$, $V_{Cont} = 7.0 Vdc$)	G_p	38.5	—	dB
Efficiency ($P_{out} = 7.0 W$, $P_{in} = 1.0 mW$)(1)	η	40	—	%
Harmonics ($P_{out} = 7.0 W$)(1) $2 f_o$ ($P_{in} = 1.0 mW$) $3 f_o$	—	—	-40 -45	dBc
Input VSWR ($P_{out} = 7.0 W$, $P_{in} = 1.0 mW$), 50 Ω Ref. (1)	—	—	2.0:1	—
Load Mismatch ($V_{S1} = V_{S2} = V_{S3} = 9.0 Vdc$) VSWR = 20:1, $P_{out} = 8 W$, $P_{in} = 5.0 mW$)(1)			No Degradation in Power Output	
Stability ($P_{in} = 1.0-30 mW$, $V_{S1} = V_{S2} = V_{S3} = 6.0-9.0 Vdc$) P_{out} between 1.0 W and 10 W (1) Load VSWR = 8:1			All spurious outputs more than 60 dB below desired signal	
Control Current ($V_{S1} = V_{S2} = V_{S3} = 7.5 V$, $P_{in} = 0 dBm$, V_{Cont} Set for $P_o = 7.0 W$)		—	325	mA

(1) Adjust V_{Cont} for specified P_{out} .

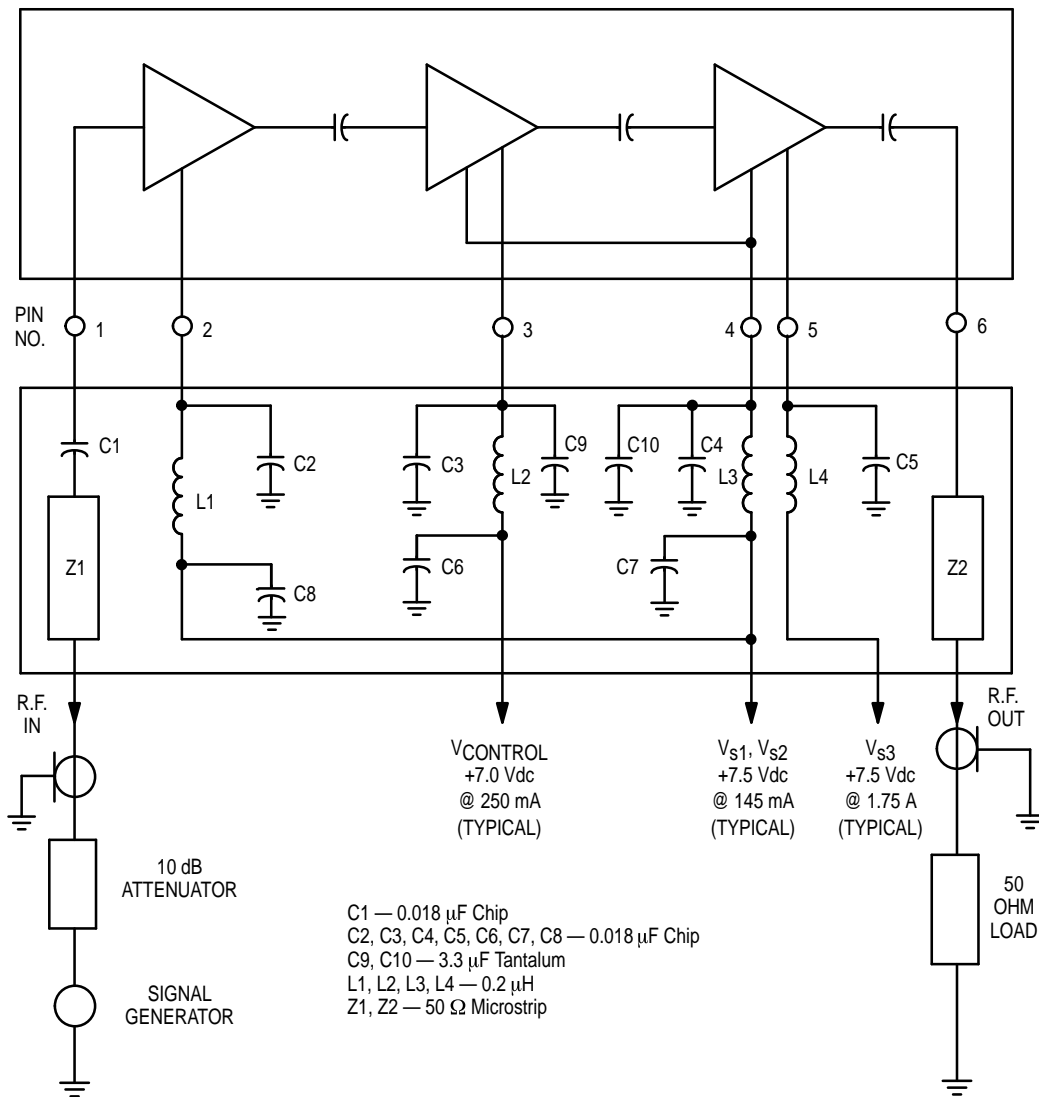

Figure 1. Power Module Test System Block Diagram

TYPICAL CHARACTERISTICS

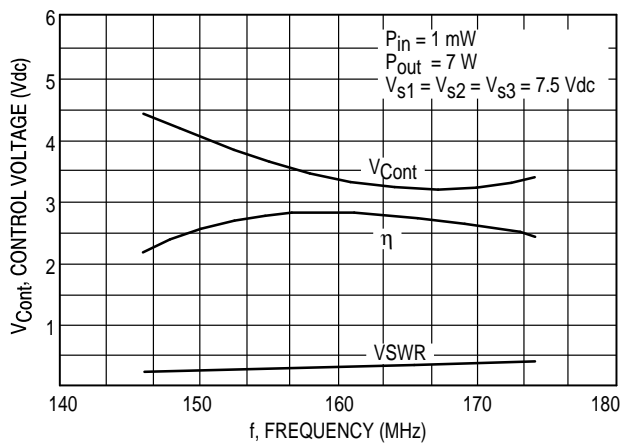

Figure 2. Control Voltage, Efficiency and VSWR versus Frequency

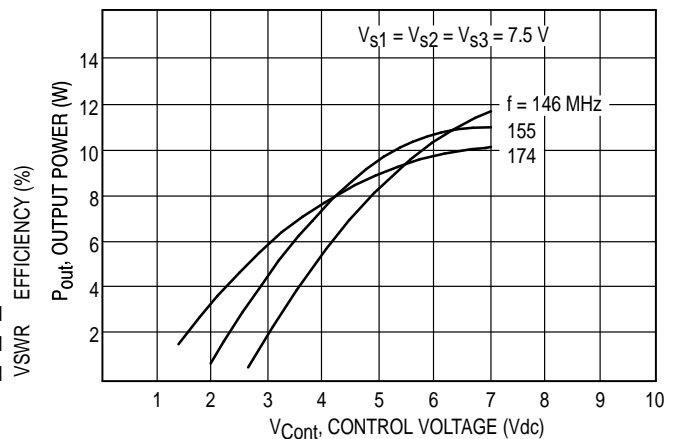

Figure 3. Output Power versus Control Voltage

TYPICAL CHARACTERISTICS

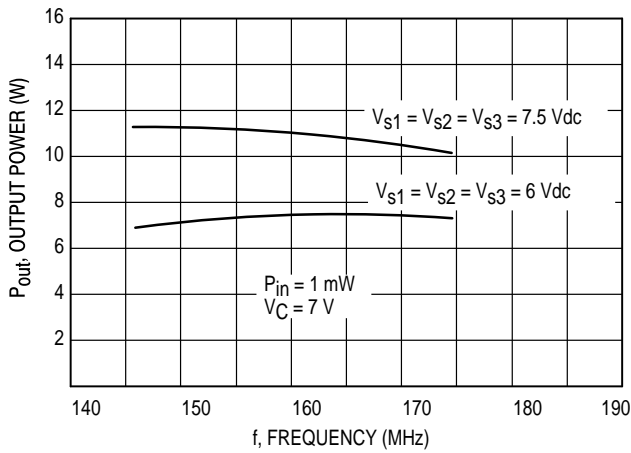

Figure 4. Output Power versus Frequency

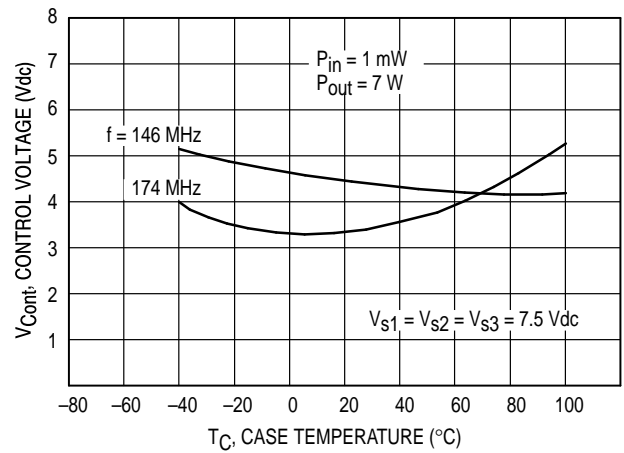

Figure 5. Control Voltage versus Case Temperature

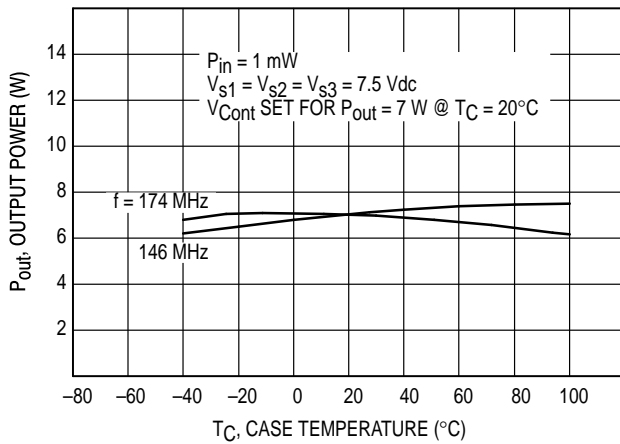

Figure 6. Output Power versus Case Temperature

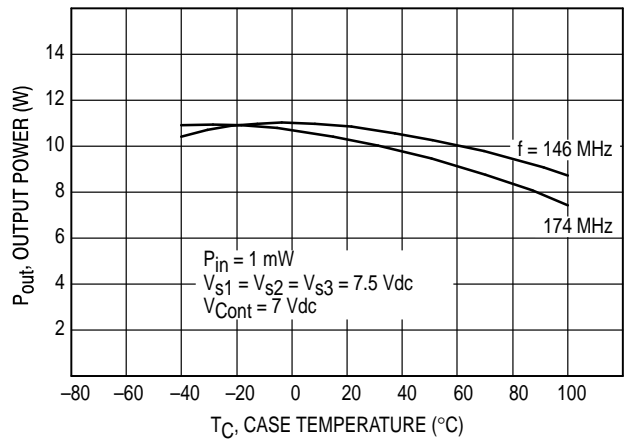

Figure 7. Output Power versus Case Temperature at Maximum Control Voltage

APPLICATIONS INFORMATION

NOMINAL OPERATION

All electrical specifications are based on the nominal conditions of $V_{S1} = V_{S2} = V_{S3} = 7.5 \text{ Vdc}$ (Pins 2, 4, 5) and P_{Out} equal to 7.0 watts. With these conditions, maximum current density on any device is $1.5 \times 10^5 \text{ A/cm}^2$ and maximum die temperature with 100°C case operating temperature is 165°C . While the modules are designed to have excess gain margin with ruggedness, operation of these units outside the limits of published specifications is not recommended unless prior communications regarding intended use have been made with the factory representative.

GAIN CONTROL

The module output should be limited to 7.0 watts. The preferred method of power output control is to fix $V_{S1} = V_{S2} = V_{S3} = 7.5 \text{ Vdc}$ (Pins 2, 4, 5), P_{in} (Pin 1) at 1.0 mW, and vary V_{Cont} (Pin 3) voltage.

DECOUPLING

Due to the high gain of the three stages and the module size limitation, external decoupling networks require careful consideration. Pins 2, 3, 4 and 5 are internally bypassed with a $0.018 \mu\text{F}$ chip capacitor which is effective for frequencies from 5.0 MHz through 174 MHz. For bypassing frequencies below 5.0 MHz, networks equivalent to that shown in Figure 1 are recommended. Inadequate decoupling will result in spurious outputs at certain operating frequencies and certain phase angles of input and output VSWR.

LOAD MISMATCH

During final test, each module is load mismatch tested in a fixture having the identical decoupling networks described in Figure 1. Electrical conditions are $V_{S1} = V_{S2} = V_{S3}$ equal to 9.0 Vdc, VSWR equal to 20:1, and output power equal to 8.0 watts.

PACKAGE DIMENSIONS

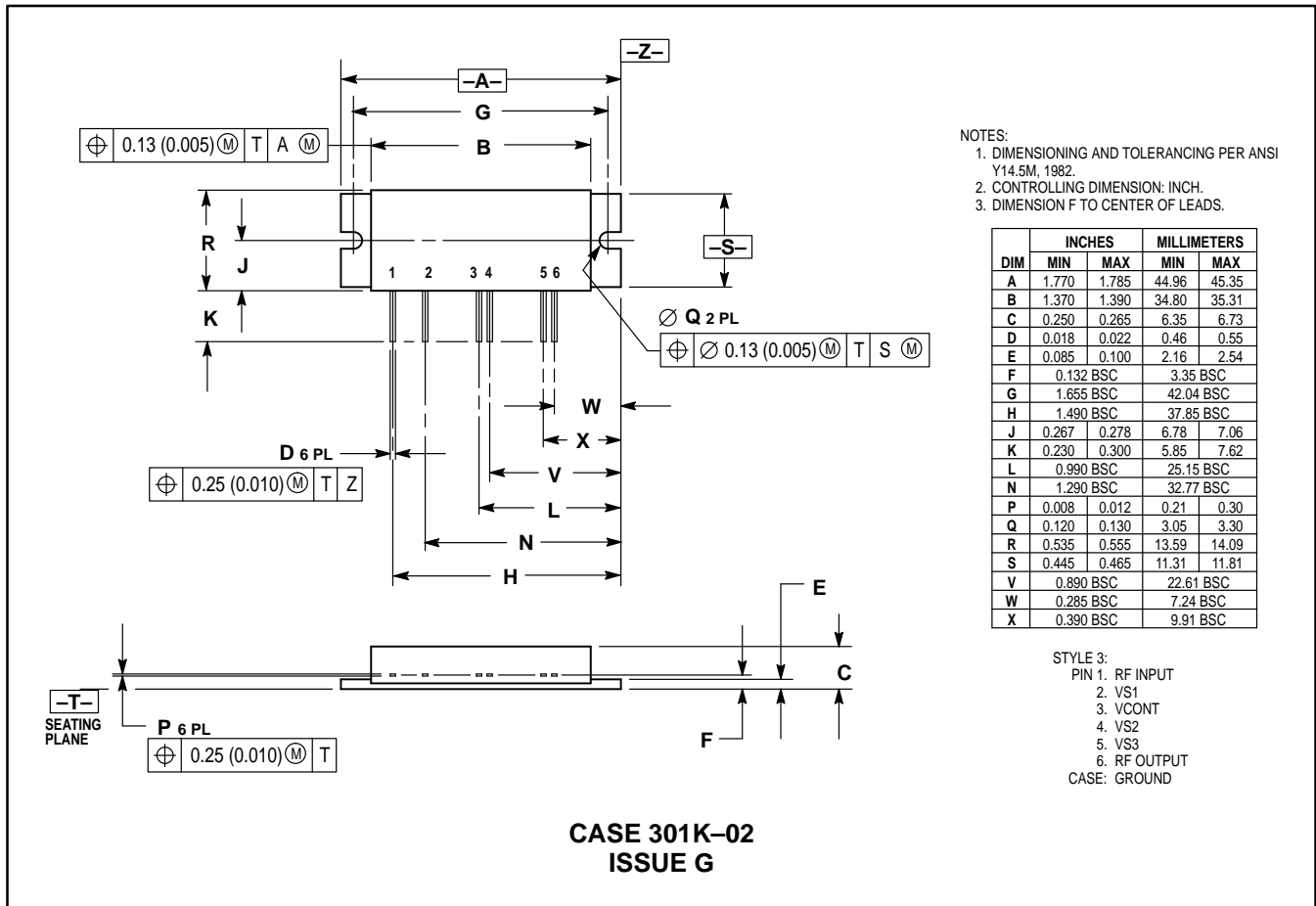

Motorola reserves the right to make changes without further notice to any products herein. Motorola makes no warranty, representation or guarantee regarding the suitability of its products for any particular purpose, nor does Motorola assume any liability arising out of the application or use of any product or circuit, and specifically disclaims any and all liability, including without limitation consequential or incidental damages. "Typical" parameters can and do vary in different applications. All operating parameters, including "Typicals" must be validated for each customer application by customer's technical experts. Motorola does not convey any license under its patent rights nor the rights of others. Motorola products are not designed, intended, or authorized for use as components in systems intended for surgical implant into the body, or other applications intended to support or sustain life, or for any other application in which the failure of the Motorola product could create a situation where personal injury or death may occur. Should Buyer purchase or use Motorola products for any such unintended or unauthorized application, Buyer shall indemnify and hold Motorola and its officers, employees, subsidiaries, affiliates, and distributors harmless against all claims, costs, damages, and expenses, and reasonable attorney fees arising out of, directly or indirectly, any claim of personal injury or death associated with such unintended or unauthorized use, even if such claim alleges that Motorola was negligent regarding the design or manufacture of the part. Motorola and  are registered trademarks of Motorola, Inc. Motorola, Inc. is an Equal Opportunity/Affirmative Action Employer.

How to reach us:

USA / EUROPE: Motorola Literature Distribution;
P.O. Box 20912; Phoenix, Arizona 85036. 1-800-441-2447

JAPAN: Nippon Motorola Ltd.; Tatsumi-SPD-JLDC, Toshikatsu Otsuki,
6F Seibu-Butsuryu-Center, 3-14-2 Tatsumi Koto-Ku, Tokyo 135, Japan. 03-3521-8315

MFAX: RMFAX0@email.sps.mot.com – TOUCHTONE (602) 244-6609
INTERNET: <http://Design-NET.com>

HONG KONG: Motorola Semiconductors H.K. Ltd.; 8B Tai Ping Industrial Park,
51 Ting Kok Road, Tai Po, N.T., Hong Kong. 852-26629298



MHW607/D

