

# Comlinear CLC103

## Fast Settling, High Current Wideband Op Amp

### General Description

The CLC103 is a high-power, wideband op amp designed for the most demanding high-speed applications. The wide bandwidth, fast settling, linear phase, and very low harmonic distortion provide the designer with the signal fidelity needed in applications such as driving flash A to Ds. **The 80MHz full-power bandwidth and 200mA output current of the CLC103 eliminate the need for power buffers in most applications;** the CLC103 is an excellent choice for driving large high-speed signals into coaxial lines.

In the design of the CLC103 special care was taken in order to guarantee that the output settle quickly to within 0.4% of the final value for use with ultra fast flash A to D converters. This is one of the most demanding of all op amp requirements since settling time is affected by the op amp's bandwidth, passband gain flatness, and harmonic distortion. This high degree of performance ensures excellent performance in many other demanding applications as well.

The dynamic performance of the CLC103 is based on Comlinear's proprietary op amp topology. This new design provides performance far beyond that available from conventional op amp designs; unlike conventional op amps where optimum gain-bandwidth product occurs at a high gain, minimum settling time at a gain of -1, and maximum slew rate at a gain of +1, the Comlinear design provides consistent, predictable performance across its entire gain range. For example, the table below shows how **the -3dB bandwidth remains nearly constant over a wide range of gains.** And since the amplifier is inherently stable, no external compensation is required. The result is shorter design time and the ability to accommodate design changes (in gain, for example) without loss of performance or redesign of compensation circuits.

The CLC103 is constructed using thin film resistor/bipolar transistor technology, and is available in two versions:

CLC103AI	-25°C to +85°C	24-pin ceramic DIP
CLC103AM	-55°C to +125°C	24-pin ceramic DIP, MIL-STD-883, Level B

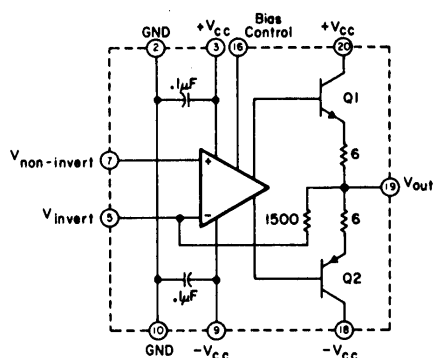

CLC103 Equivalent Circuit Diagram  
(all undesignated pins are internally unconnected)

### Features

- 80MHz full-power bandwidth (20V<sub>pp</sub>, 100Ω)
- 200mA output current
- 0.4% settling in 10ns
- 600V/μs slew rate
- 4ns rise and fall times (20V)

### Applications

- Coaxial line driving
- DAC current to voltage amplifier
- Flash A to D
- Baseband and video communications
- Radar and IF processors

Small Signal Pulse Response

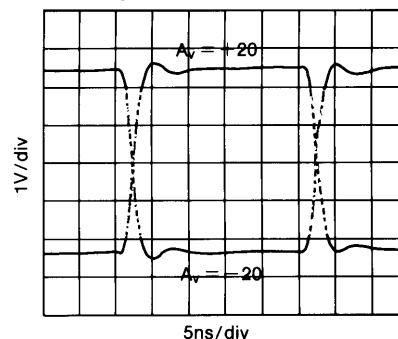

Package Dimensions

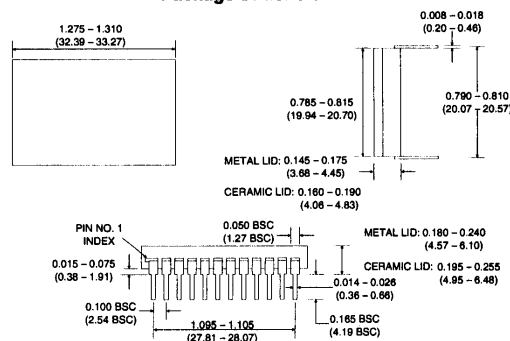

### Typical Performance

parameter	gain setting						units
	+4	+20	+40	-4	-20	-40	
-3dB bandwidth	230	150	130	155	145	125	MHz
rise time (20V)	4	4	4	4	4	4	ns
slew rate	6	6	6	6	6	6	V/ns
settling time (0.4%)	10	10	12	10	10	12	ns

# CLC103 Electrical Characteristics ( $A_V = +20$ , $V_{CC} = \pm 15V$ , $R_L = 100\Omega$ unless specified)

PARAMETERS	CONDITIONS	TYP	MAX & MIN RATINGS <sup>1</sup>			UNITS	SYMBOL
Ambient Temperature <sup>1</sup>	CLC103AM	+25°C	-55°C	+25°C	+125°C		
Ambient Temperature <sup>1</sup>	CLC103AI	+25°C	-25°C	+25°C	+85°C		
<b>FREQUENCY DOMAIN RESPONSE</b>							
* -3dB bandwidth	$V_{out} < 4V_{pp}$	150	>125	>135	>120	MHz	SSBW
gain flatness	$V_{out} < 4V_{pp}$						
* peaking	0.1 to 50MHz	0.1	<0.6	<0.3	<0.3	dB	GFPL
* peaking	>50MHz	0.2	<1.5	<0.6	<0.6	dB	GFPH
* rolloff	at 100MHz	—	<0.4	<0.6	<0.8	dB	GFR
group delay	to 75MHz	3.0	—	—	—	ns	GD
linear phase deviation	to 75MHz	1	<3	<2	<4	°	LPD
reverse isolation - non-inverting	to 150MHz	55	>45	>45	>45	dB	RINI
<b>TIME DOMAIN RESPONSE</b>							
rise and fall time	5V step	2.3	<2.8	<2.6	<2.9	ns	TRS
	20V step	4	<5	<5	<5	ns	TRL
settling time to 0.4%	10V step	10	<25	<20	<25	ns	TSP
overshoot	5V step	5	<15	<10	<10	%	OS
slew rate (overdriven input)		6	>5	>5	>5	V/ns	SR
overload recovery							
<50ns pulse, 200% overdrive		30	—	—	—	ns	OR
<b>DISTORTION AND NOISE RESPONSE</b>							
* 2nd harmonic distortion	$2V_{pp}$ , 20MHz	-48	<-40	<-40	<-40	dBc	HD2
* 3rd harmonic distortion	$2V_{pp}$ , 20MHz	-48	<-40	<-40	<-40	dBc	HD3
equivalent input noise							
noise floor	>100kHz	-158	<-152	<-152	<-152	dBm(1Hz)	SNF
integrated noise	1kHz to 100MHz	28	<56	<56	<56	$\mu V$	INV
noise floor	>5MHz	-158	<-152	<-152	<-152	dBm(1Hz)	SNF
integrated noise	5MHz to 100MHz	28	<56	<56	<56	$\mu V$	INV
<b>STATIC, DC PERFORMANCE</b>							
* input offset voltage		10	<30	<25	<30	mV	VIO
average temperature coefficient		35	<120	<120	<120	$\mu V/^\circ C$	DVIO
* input bias current	non-inverting	10	<40	<30	<40	$\mu A$	IBN
average temperature coefficient		20	<125	<125	<125	$nA/^\circ C$	DIBN
* input bias current	inverting	20	<110	<60	<110	$\mu A$	IBI
average temperature coefficient		250	<500	<500	<500	$nA/^\circ C$	DIBI
* power supply rejection ratio		54	>45	>45	>45	dB	PSRR
common mode rejection ratio		38	>30	>30	>30	dB	CMRR
* supply current	no load	30	<36	<34	<36	mA	ICC
<b>MISCELLANEOUS PERFORMANCE</b>							
non-inverting input	resistance	250	>100	>100	>100	k $\Omega$	RIN
	capacitance	2.4	<3	<3	<3	pF	CIN
output impedance	at DC	—	<0.1	<0.1	<0.1	$\Omega$	RO
	at 100MHz	2, 45	—	—	—	$\Omega$ , nH	ZO
output voltage range	no load	—	> $\pm 11$	> $\pm 11$	> $\pm 11$	V	VO

Min/max ratings are based on product characterization and simulation. Individual parameters are tested as noted. Outgoing quality levels are determined from tested parameters.

## Absolute Maximum Ratings

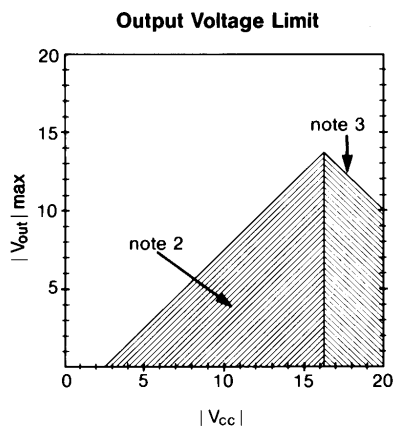

supply voltage ( $V_{CC}$ )	$\pm 20V$
output current	$\pm 200mA$
thermal resistance ( $\theta_{ca}$ )	see thermal model
junction temperature	+175°C
operating temperature	AI: -25°C to +85°C AM: -55°C to +125°C
storage temperature	-65°C to +150°C
lead temperature (soldering 10s)	+300°C

**\*note 1:** Parameters preceded by an \* are the final electrical test parameters and are 100% tested. AM units are tested at -55°C, +25°C, and +125°C. AI units are tested only at +25°C although their performance is guaranteed at -25°C and +85°C as indicated above.

**note 2:** This rating protects against damage to the input stage caused by saturation of either the input or output stages. Under transient conditions not exceeding 1 $\mu s$  (duty cycle not exceeding 10%, maximum input voltage may be as large as twice the maximum.  $V_{cm}$  should never exceed  $\pm 5V$ . ( $V_{cm}$  is the voltage at the non-inverting input, pin 7.)

**note 3:** This rating protects against exceeding transistor collector-emitter breakdown ratings. Recommended  $V_{CC}$  is  $\pm 15V$ .

# CLC103 Typical Performance Characteristics ( $A_v = +20$ , $V_{CC} = \pm 15V$ , $R_L = 100\Omega$ ; unless specified)

**Non-Inverting Gain and Phase**

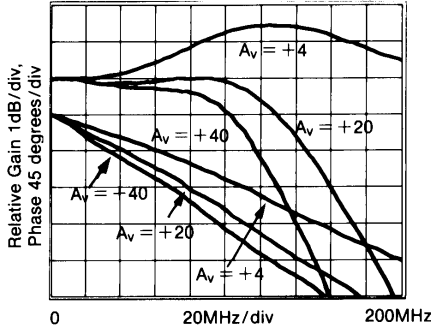

**Inverting Gain and Phase**

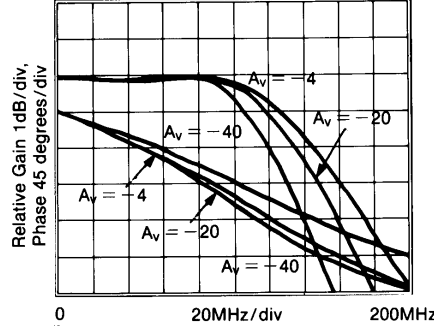

**Broadband Inverting and Non-Inverting Gain**

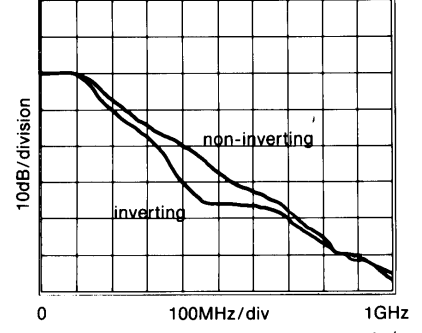

**Large Signal Gain and Phase**

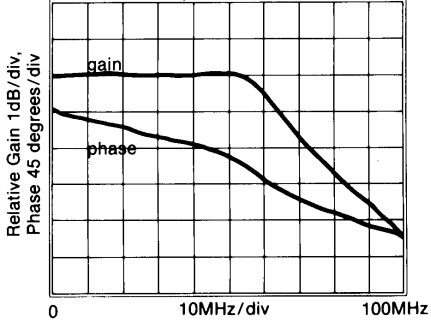

**Relative Bandwidth vs. Vcc**

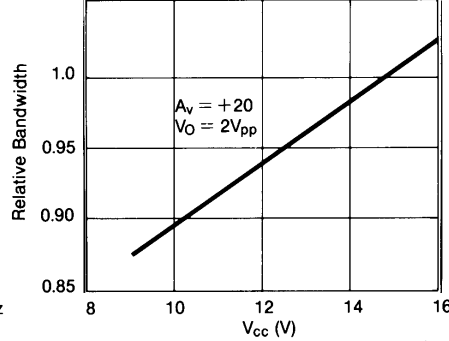

**Gain vs. Frequency for Various Loads**

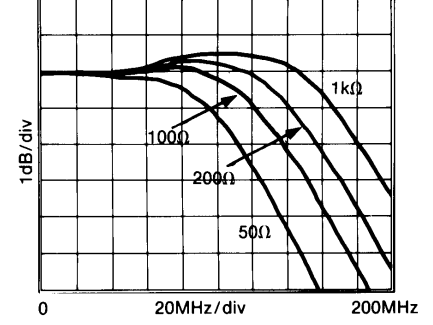

**Small Signal Pulse Response (Inv, Non-Inv)**

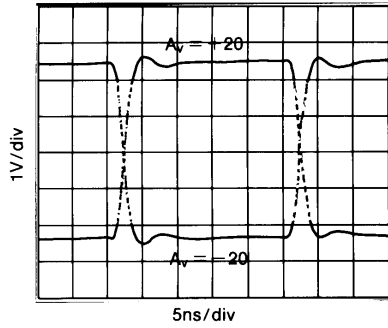

**Large Signal Pulse Response (Inv, Non-Inv)**

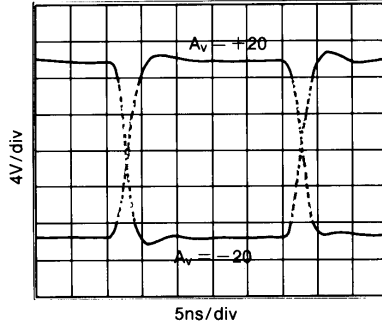

**Settling Time**

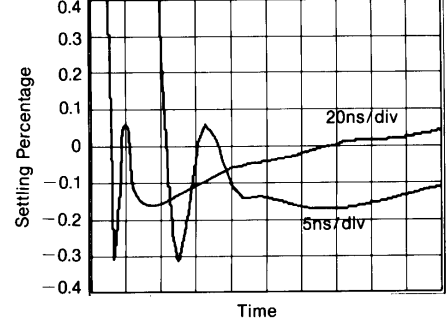

**2nd and 3rd Harmonic Distortion Intercept**

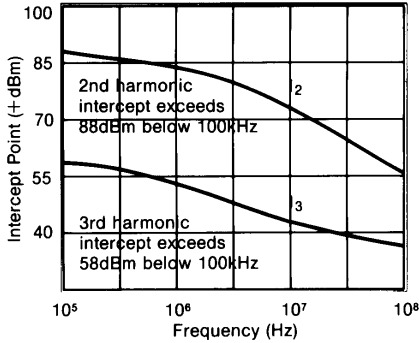

**2-Tone 3rd Order Intermod. Intercept**

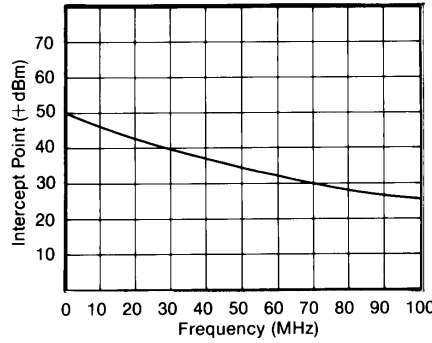

**CMRR and PSRR**

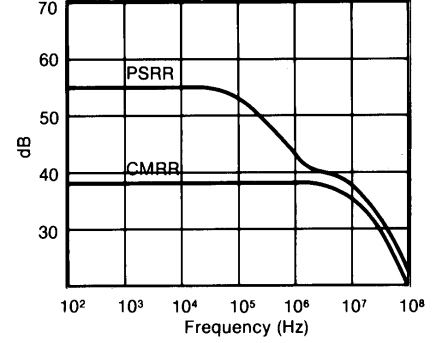

**Equivalent Input Noise**

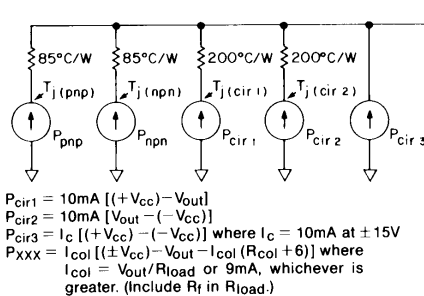
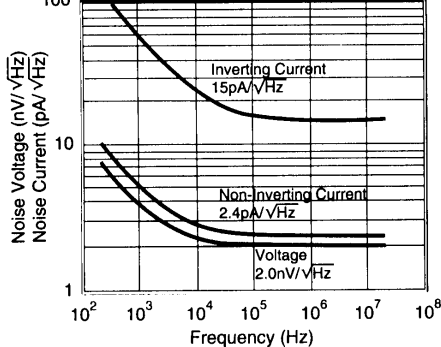

$\theta_{ca} = 23^\circ C/W$  in still air without a heatsink (With heat sinking or air flow,  $\theta_{ca}$  will be lower.)  
 $T_{ambient}$   
 (For positive  $V_{out}$  and  $V_{CC}$ ,  $P_{xxx}$  is the power in the npn device. For negative  $V_{out}$  and  $V_{CC}$ , this power is in the pnp device.)  
 $R_{col}$  is an external resistor (22 ohms recommended) between the xxx collector and  $\pm V_{CC}$ .  
 $T_j(pnp) = (P_{pnp}) 85^\circ C/W + (P_{total}) \theta_{ca} + T_{ambient}$ , similar for  $T_j(npn)$ .  
 $T_j(cir1) = (P_{cir1}) 200^\circ C/W + (P_{total}) \theta_{ca} + T_{ambient}$ , similar for  $T_j(cir2)$ .

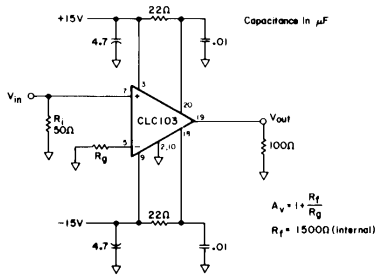

Figure 1: recommended non-inverting gain circuit

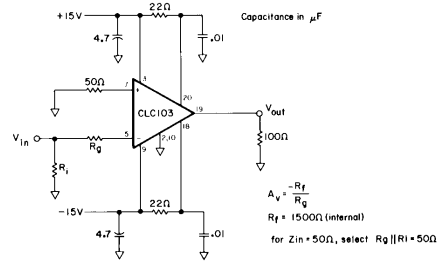

Figure 2: recommended inverting gain circuit

Test fixture layout artwork is available upon request.

### CLC103 Operation

The CLC103 is based on Comlinear's proprietary op amp topology, a unique design which uses current feedback instead of the usual voltage feedback. This design provides dynamic performance far beyond that previously available, yet it is used basically the same as the familiar voltage-feedback op amp (see the gain equations above). A complete discussion of current feedback is given in application note AN300-1.

### Layout Considerations

To obtain optimum performance from any circuit operating at high frequencies, good PC layout is essential. Fortunately, the stable, well-behaved response of the CLC103 makes operation at high frequencies less sensitive to layout than is the case with other wideband op amps, even though the CLC103 has a much wider bandwidth.

In general, a good layout is one which minimizes the unwanted coupling of a signal between nodes in a circuit. A continuous ground plane from the signal input to output on the circuit side of the board is helpful. Traces should be kept short to minimize inductance. If long traces are needed, use microstrip transmission lines which are terminated in their characteristic impedance. At some high-impedance nodes, or in sensitive areas such as near pin 5 of the CLC103, stray capacitance should be kept small by keeping nodes small and removing ground plane directly around the node.

The  $\pm V_{cc}$  connections to the CLC103 are internally bypassed to ground with 0.1  $\mu\text{F}$  capacitors to provide good high-frequency decoupling. It is recommended that 1  $\mu\text{F}$  or larger tantalum capacitors be provided for low-frequency decoupling. The 0.01  $\mu\text{F}$  capacitors shown at pins 18 and 20 in figures 1 and 2 should be kept within 0.1" of those pins. A wide strip of ground plane should be provided for a signal return path between the load-resistor ground and these capacitors.

Since the layout of the PC board forms such an important part of the circuit, much time can be saved if prototype amplifier boards are tested early in the design stage. Encased/connectorized amplifiers are available from Comlinear.

### Settling Time, Offset, and Drift

After an output transition has occurred, the output settles very rapidly to the final value and no change occurs for several microseconds. Thereafter, thermal gradients inside the CLC103 will cause the output to begin to drift. When this cannot be tolerated, or when the initial offset voltage and drift is unacceptable, the use of a composite amplifier is advised.

A composite amplifier can also be referred to as a feed-forward amplifier. Most feed-forward techniques such as those used in the vast majority of wideband op amps, involve the use of a wideband AC-coupled channel in parallel with a low-bandwidth, high-gain DC-coupled amplifier. For the composite amplifier suggested for use with the CLC103, the CLC103 replaces the wideband AC-coupled amplifier and a low-cost monolithic op amp is used to supply high open-loop gain at low frequencies. Since the CLC103 is strictly DC coupled throughout, crossover distortion of less than 0.01dB and 1° results.

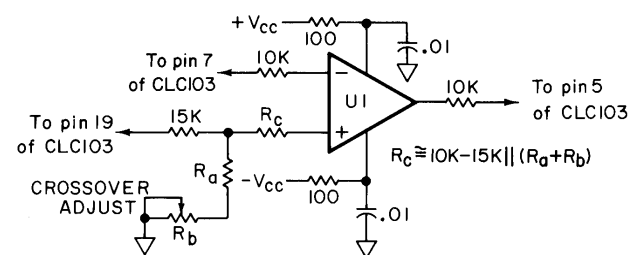

Figure 3: non-inverting gain composite amp to be used with figure 1 circuit

For composite operation in the non-inverting mode, the circuit in figure 1 should be modified by the addition of the circuit shown in figure 3. For inverting operation, modify the circuit in figure 2 by the addition of the circuit in figure 4. Keep all resistors which connect to the CLC103 within 0.2" of the CLC103 pins. The other side of these resistors should likewise be as close to U1 as possible. For good overall results, U1 should be similar to the LF356; this gives 5  $\mu\text{V}/^\circ\text{C}$  input offset drift and the crossover frequency occurs at about 2MHz. Since U1 has a feedback network composed of  $R_a + R_b$  and a 15k $\Omega$  resistor, which is in parallel with  $R_g$  and the internal 1.5k $\Omega$  feedback resistor of the CLC103,  $R_b$  must be adjusted to match the feedback ratios of the two networks. This is done by driving the composite amplifier with a 70kHz square wave large enough to produce a transition from +5V to -5V at the CLC103 output and adjusting  $R_b$  until the output of U1 is at a minimum.  $R_a$  should be about 9.5 $R_g$  for best results; thus,  $R_b$  should be adjusted around the value of 0.5 $R_g$ .

### Bias Control

In normal operation, the bias control pin (pin 16) is left unconnected. However, if control over the bias of the amplifier is desired, the bias control pin may be driven with a TTL signal; a TTL high level will turn the amplifier off.

### Distortion and Noise

The graphs of intercept point versus frequency on the preceding page make it easy to predict the distortion at any frequency, given the output voltage of the CLC103. First, convert the output voltage  $V_o$  to  $V_{rms} = (V_{pp}/2\sqrt{2})$  and then to  $P = (10\log_{10}(20V_{rms}^2))$  to get the output power in dBm. At the frequency of interest, its 2nd harmonic will be  $S_2 = (I_2 - P)$ dB below the level of P. Its third harmonic will be  $S_3 = 2(I_3 - P)$ dB below the level of P, as will the two-tone third order intermodulation products. These approximations are useful for  $P < -1$ dB compression levels.

Approximate noise figure can be determined for the CLC103 using the Equivalent Input Noise graph on the preceding page. The following equation can be used to determine noise figure (F) in dB.

$$F = 10\log \left[ 1 + \frac{v_n^2 + i_n^2 R_F^2}{4kTR_s \Delta f} \right]$$

where  $v_n$  is the rms noise voltage and  $i_n$  is the rms noise current. Beyond the breakpoint of the curves (i.e., where they are flat), broadband noise figure equals spot noise, so  $\Delta f$  should equal one (1) and  $v_n$  and  $i_n$  should be read directly off the graph. Below the breakpoint, the noise must be integrated and  $\Delta f$  set to the appropriate bandwidth.

### Application Notes and Assistance

Application notes that address topics such as data conversion, fiber optics, and general high-frequency circuit design are available from Comlinear or your Comlinear sales engineer.

Comlinear maintains a staff of highly-qualified applications engineers to provide technical and design assistance.

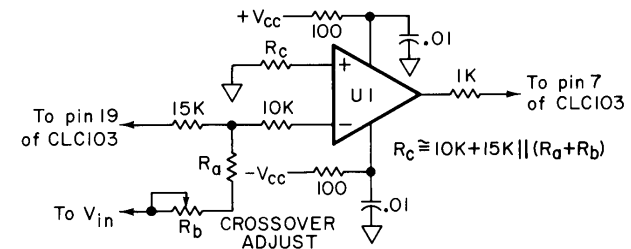

Figure 4: inverting gain composite amplifier to be used with figure 2 circuit

**This page intentionally left blank.**

---

### Customer Design Applications Support

National Semiconductor is committed to design excellence. For sales, literature and technical support, call the National Semiconductor Customer Response Group at **1-800-272-9959** or fax **1-800-737-7018**.

### Life Support Policy

National's products are not authorized for use as critical components in life support devices or systems without the express written approval of the president of National Semiconductor Corporation. As used herein:

1. Life support devices or systems are devices or systems which, a) are intended for surgical implant into the body, or b) support or sustain life, and whose failure to perform, when properly used in accordance with instructions for use provided in the labeling, can be reasonably expected to result in a significant injury to the user.
2. A critical component is any component of a life support device or system whose failure to perform can be reasonably expected to cause the failure of the life support device or system, or to affect its safety or effectiveness.



#### National Semiconductor Corporation

1111 West Bardin Road  
Arlington, TX 76017  
Tel: 1(800) 272-9959  
Fax: 1(800) 737-7018

#### National Semiconductor Europe

Fax: (+49) 0-180-530 85 86  
E-mail: europe.support.nsc.com  
Deutsch Tel: (+49) 0-180-530 85 85  
English Tel: (+49) 0-180-532 78 32  
Francais Tel: (+49) 0-180-532 93 58  
Italiano Tel: (+49) 0-180-534 16 80

#### National Semiconductor Hong Kong Ltd.

13th Floor, Straight Block  
Ocean Centre, 5 Canton Road  
Tsimshatsui, Kowloon  
Hong Kong  
Tel: (852) 2737-1600  
Fax: (852) 2736-9960

#### National Semiconductor Japan Ltd.

Tel: 81-043-299-2309  
Fax: 81-043-299-2408

---

National does not assume any responsibility for use of any circuitry described, no circuit patent licenses are implied and National reserves the right at any time without notice to change said circuitry and specifications.