

- Converts Light Intensity to Output Voltage
- Monolithic Silicon IC Containing Photodiode, Transconductance Amplifier, and Feedback Components
- Single-Supply Operation . . . 2.7 V to 5.5 V
- High Irradiance Responsivity . . . Typical 96 mV/( $\mu\text{W}/\text{cm}^2$ ) at  $\lambda_p = 640 \text{ nm}$  (TSL12T)
- Low Supply Current . . . 1.1 mA Typical
- Low-Profile Surface-Mount Package
- RoHS Compliant

PACKAGE T  
4-LEAD SMD  
(TOP VIEW)

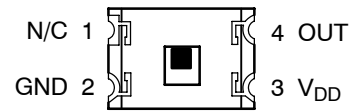

## Description

The TSL12T and TSL13T are cost-optimized, highly integrated light-to-voltage optical sensors, each combining a photodiode and a transimpedance amplifier (feedback resistor = 80 M $\Omega$  and 20 M $\Omega$ , respectively) on a single monolithic integrated circuit. The photodiode active area is 0.5 mm  $\times$  0.5 mm and the sensors respond to light in the range of 320 nm to 1050 nm. Output voltage is linear with light intensity (irradiance) incident on the sensor over a wide dynamic range. These devices are supplied in a low-profile surface-mount package (T).

## Functional Block Diagram

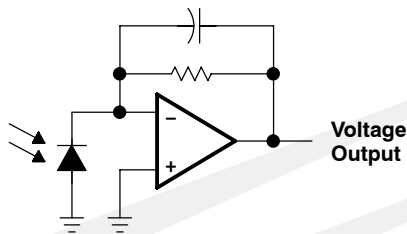

## Available Options

DEVICE	T <sub>A</sub>	PACKAGE – LEADS	PACKAGE DESIGNATOR	ORDERING NUMBER
TSL12	0°C to 70°	4-lead Low-Profile Surface-Mount	T	TSL12T
TSL13	0°C to 70°	4-lead Low-Profile Surface-Mount	T	TSL13T

# TSL12T, TSL13T LIGHT-TO-VOLTAGE CONVERTERS

TAOS062D – APRIL 2007

## Terminal Functions

TERMINAL		DESCRIPTION
NAME	T PKG NO.	
GND	2	Power supply ground (substrate). All voltages are referenced to GND.
OUT	4	Output voltage.
V <sub>DD</sub>	3	Supply voltage.
N/C	1	No connection.

## Absolute Maximum Ratings over operating free-air temperature range (unless otherwise noted)<sup>†</sup>

Supply voltage, V <sub>DD</sub> (see Note 1)	6 V
Output current, I <sub>O</sub>	±10 mA
Duration of short-circuit current at (or below) 25°C (see Note 2)	5 s
Operating free-air temperature range, T <sub>A</sub>	–25°C to 85°C
Storage temperature range, T <sub>stg</sub>	–25°C to 85°C
Solder conditions in accordance with JEDEC J–STD–020A, maximum temperature	260°C

<sup>†</sup> Stresses beyond those listed under “absolute maximum ratings” may cause permanent damage to the device. These are stress ratings only, and functional operation of the device at these or any other conditions beyond those indicated under “recommended operating conditions” is not implied. Exposure to absolute-maximum-rated conditions for extended periods may affect device reliability.

- NOTES: 1. All voltages are with respect to GND.  
2. Output may be shorted to supply.

## Recommended Operating Conditions

	MIN	NOM	MAX	UNIT
Supply voltage, V <sub>DD</sub>	2.7		5.5	V
Operating free-air temperature, T <sub>A</sub>	0		70	°C

**Electrical Characteristics at  $V_{DD} = 5\text{ V}$ ,  $T_A = 25^\circ\text{C}$ ,  $\lambda_p = 640\text{ nm}$ ,  $R_L = 10\text{ k}\Omega$  (unless otherwise noted) (see Notes 3, 4, 5)**

PARAMETER	TEST CONDITIONS	TSL12T			TSL13T			UNIT
		MIN	TYP	MAX	MIN	TYP	MAX	
$V_{OM}$ Maximum output voltage		4.6	4.9		4.6	4.9		V
$V_O$ Output voltage	$E_e = 20.5\ \mu\text{W}/\text{cm}^2$	1.5	2	2.5				V
	$E_e = 83\ \mu\text{W}/\text{cm}^2$				1.5	2	2.5	
	$E_e = 41\ \mu\text{W}/\text{cm}^2$		4					
	$E_e = 166\ \mu\text{W}/\text{cm}^2$					4		
$R_e$ Irradiance responsivity	Note 6		96			24		mV/ ( $\mu\text{W}/\text{cm}^2$ )
$V_{OS}$ Extrapolated offset voltage	Note 6	-0.02	0.03	0.08	-0.02	0.03	0.08	V
$V_d$ Dark voltage	$E_e = 0$	0		0.08	0		0.08	V
$I_D$ Supply current	$E_e = 20.5\ \mu\text{W}/\text{cm}^2$		1.1	1.7				mA
	$E_e = 83\ \mu\text{W}/\text{cm}^2$					1.1	1.7	

- NOTES: 3. Measurements are made with  $R_L = 10\text{ k}\Omega$  between output and ground.  
 4. Optical measurements are made using small-angle incident radiation from an LED optical source.  
 5. The 640 nm input irradiance  $E_e$  is supplied by an AlInGaP LED with peak wavelength  $\lambda_p = 640\text{ nm}$ .  
 6. Irradiance responsivity is characterized over the range  $V_O = 0.2$  to 4 V. The best-fit straight line of Output Voltage  $V_O$  versus irradiance  $E_e$  over this range may have a positive or negative extrapolated  $V_O$  value for  $E_e = 0$ . For low irradiance values, the output voltage  $V_O$  versus irradiance  $E_e$  characteristic is non linear with a deviation toward  $V_O = 0$ ,  $E_e = 0$  origin from the best-fit straight line referenced above.

**Dynamic Characteristics at  $V_{DD} = 5\text{ V}$ ,  $T_A = 25^\circ\text{C}$ ,  $\lambda_p = 640\text{ nm}$ ,  $R_L = 10\text{ k}\Omega$  (unless otherwise noted) (see Figure 1)**

PARAMETER	TEST CONDITIONS	TSL12T			TSL13T			UNIT
		MIN	TYP	MAX	MIN	TYP	MAX	
$t_{dr}$ Output pulse delay time for rising edge (0% to 10%)	Min $V_O = 0\text{ V}$ ; Peak $V_O = 2\text{ V}$		13			1.7		$\mu\text{s}$
	Min $V_O = 0.5\text{ V}$ ; Peak $V_O = 2\text{ V}$		2.3			1.2		
$t_r$ Output pulse rise time (10% to 90%)	Min $V_O = 0\text{ V}$ ; Peak $V_O = 2\text{ V}$		20			7.2		$\mu\text{s}$
	Min $V_O = 0.5\text{ V}$ ; Peak $V_O = 2\text{ V}$		10			6.5		
$t_{df}$ Output pulse delay time for falling edge (100% to 90%)	Min $V_O = 0\text{ V}$ ; Peak $V_O = 2\text{ V}$		2.3			1.2		$\mu\text{s}$
	Min $V_O = 0.5\text{ V}$ ; Peak $V_O = 2\text{ V}$		2.2			1.1		
$t_f$ Output pulse fall time (90% to 10%)	Min $V_O = 0\text{ V}$ ; Peak $V_O = 2\text{ V}$		10			6.8		$\mu\text{s}$
	Min $V_O = 0.5\text{ V}$ ; Peak $V_O = 2\text{ V}$		9			6.4		

# TSL12T, TSL13T LIGHT-TO-VOLTAGE CONVERTERS

TAOS062D – APRIL 2007

## PARAMETER MEASUREMENT INFORMATION

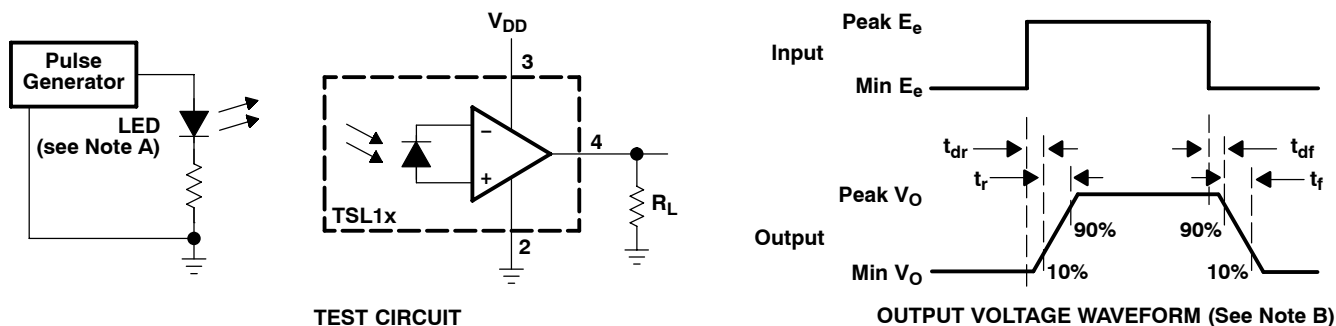

- NOTES: A. The input irradiance is supplied by a pulsed AlInGaP light-emitting diode with the following characteristics:  $\lambda_p = 640 \text{ nm}$ ,  $t_r < 1 \mu\text{s}$ ,  $t_f < 1 \mu\text{s}$ .
- B. The output waveform is monitored on an oscilloscope with the following characteristics:  $t_r < 100 \text{ ns}$ ,  $Z_i \geq 1 \text{ M}\Omega$ ,  $C_i \leq 20 \text{ pF}$ .

Figure 1. Switching Times

## TYPICAL CHARACTERISTICS

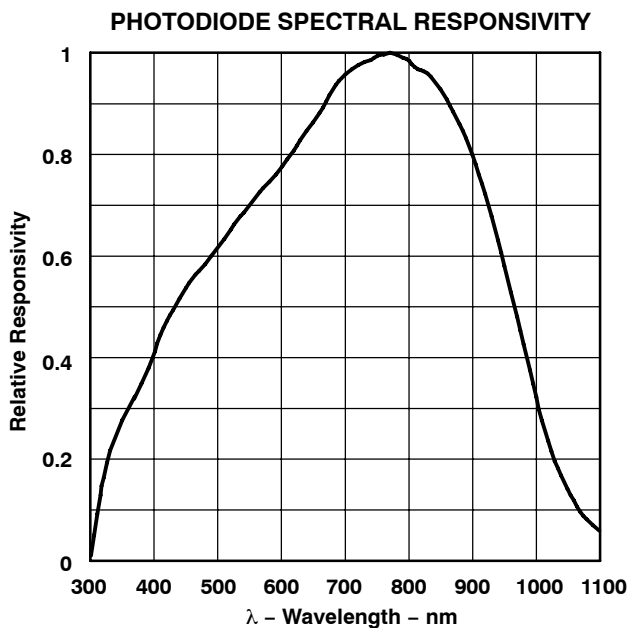

Figure 2

TYPICAL CHARACTERISTICS

TSL12T

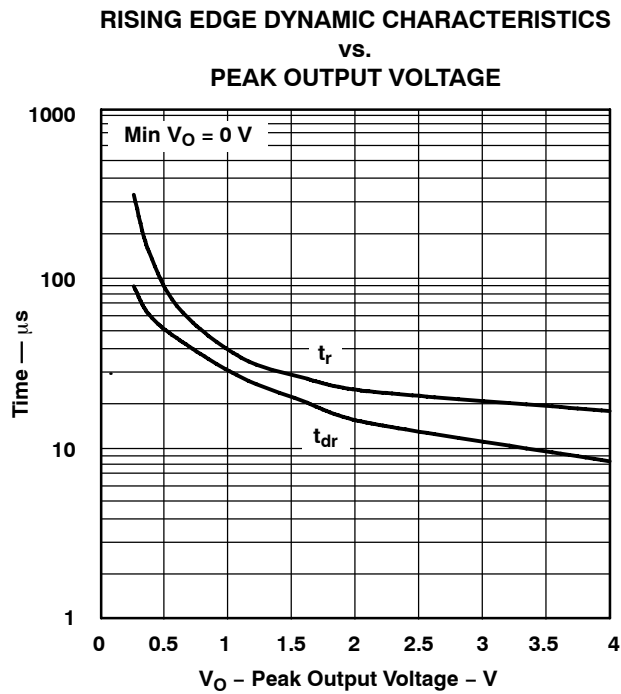

Figure 3

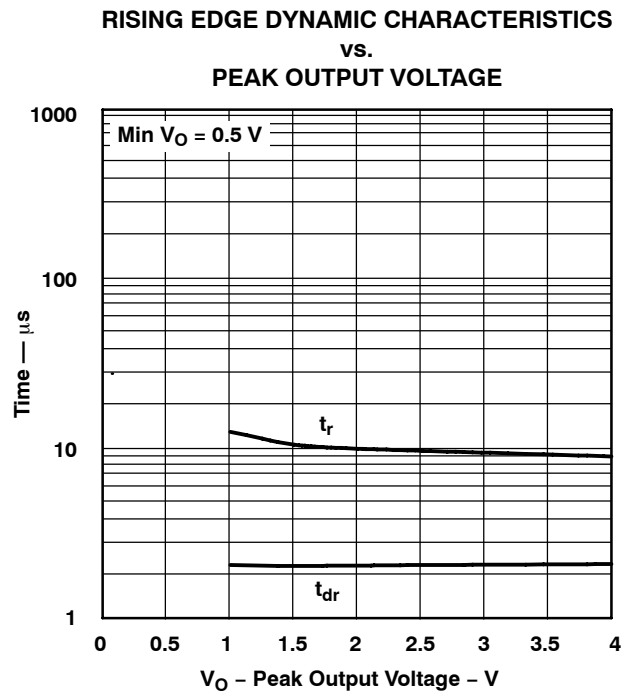

Figure 4

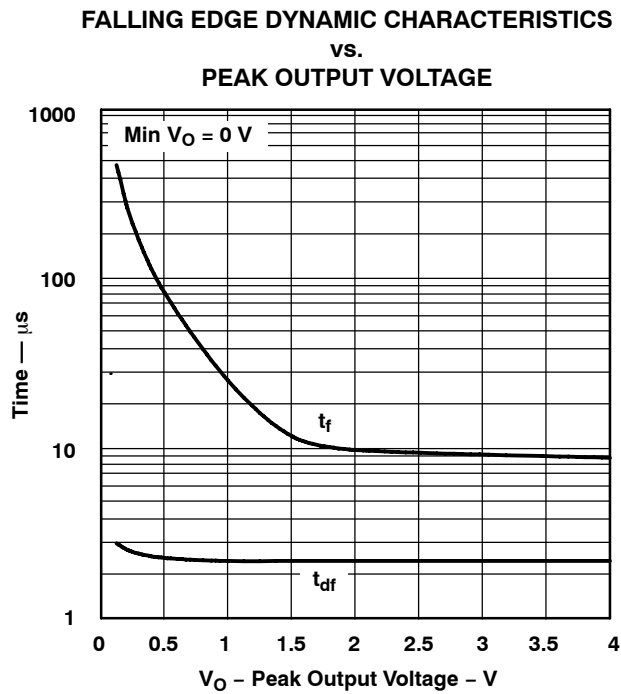

Figure 5

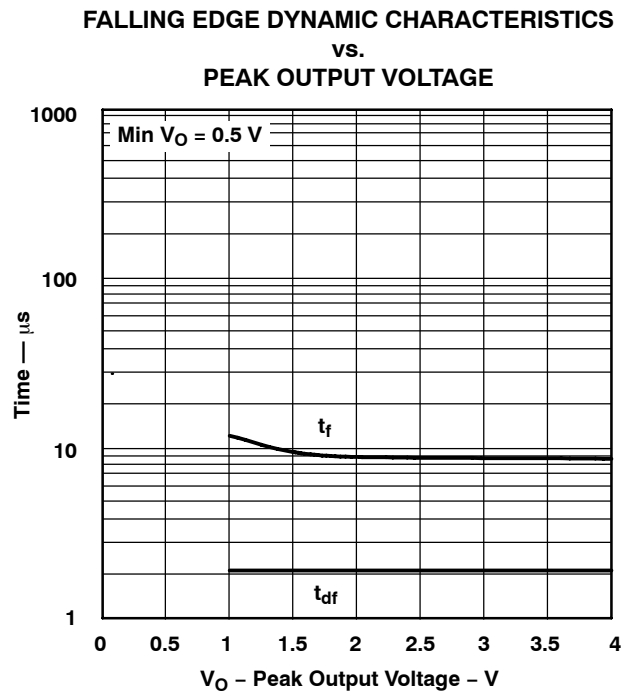

Figure 6

# TSL12T, TSL13T LIGHT-TO-VOLTAGE CONVERTERS

TAOS062D – APRIL 2007

## TYPICAL CHARACTERISTICS

### TSL12T

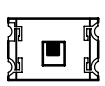

NORMALIZED OUTPUT VOLTAGE  
vs.  
ANGULAR DISPLACEMENT

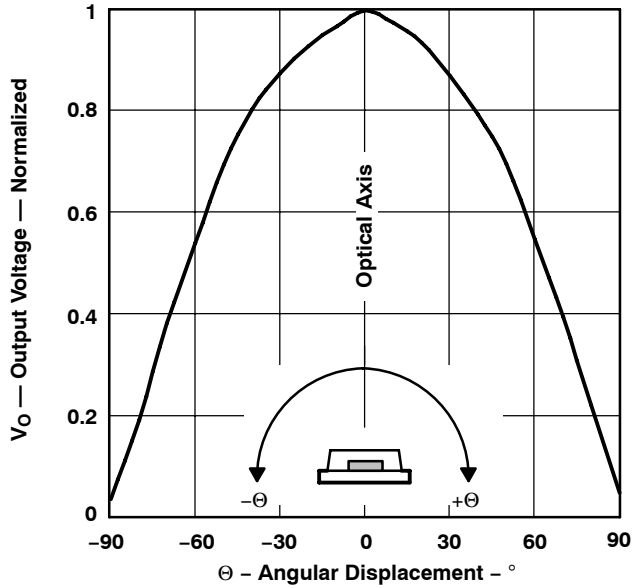
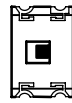

Figure 7



NORMALIZED OUTPUT VOLTAGE  
vs.  
ANGULAR DISPLACEMENT

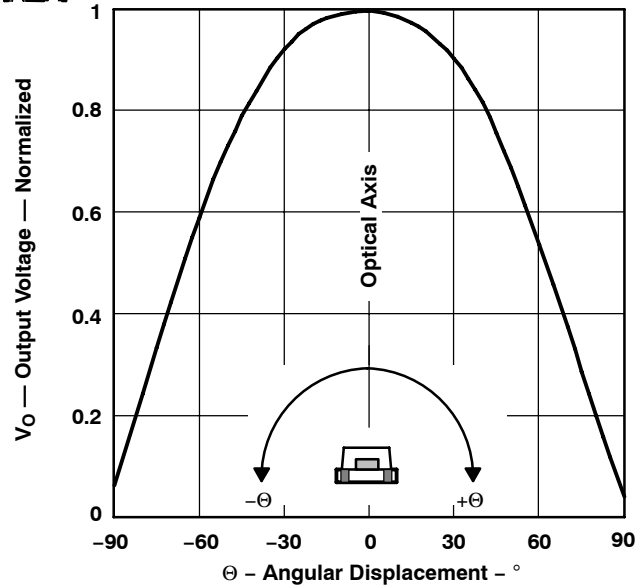

Figure 8

TYPICAL CHARACTERISTICS

TSL13T

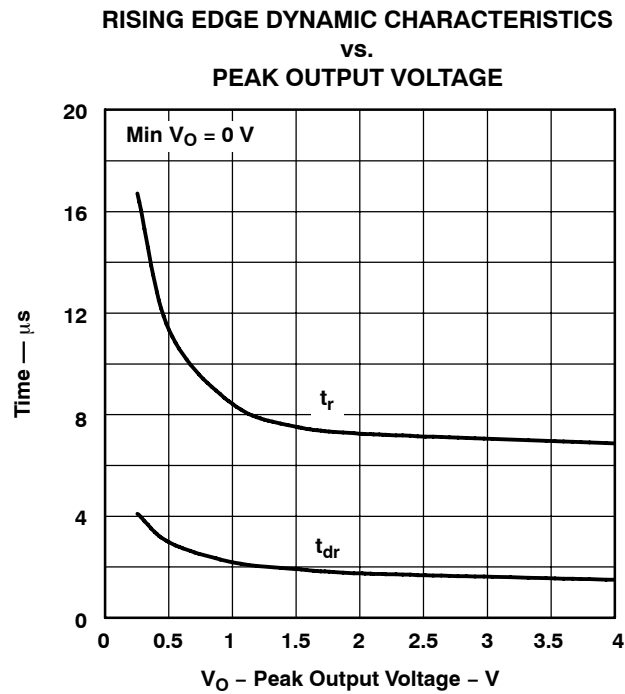

Figure 9

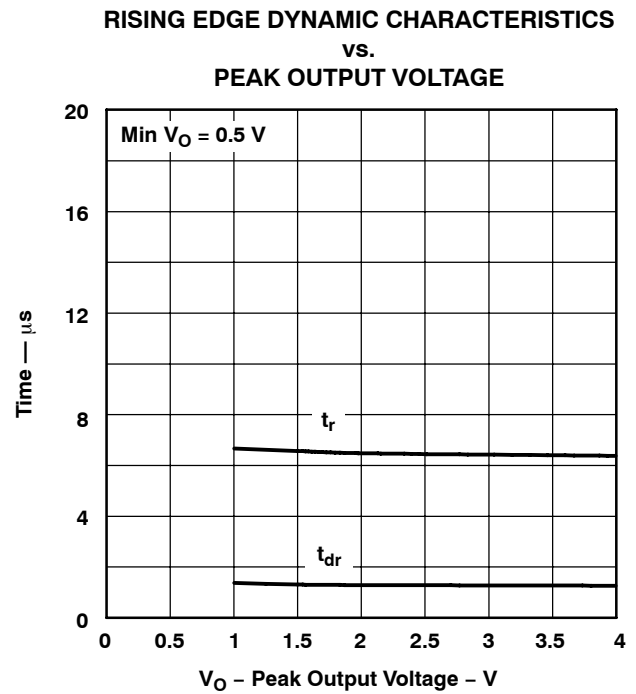

Figure 10

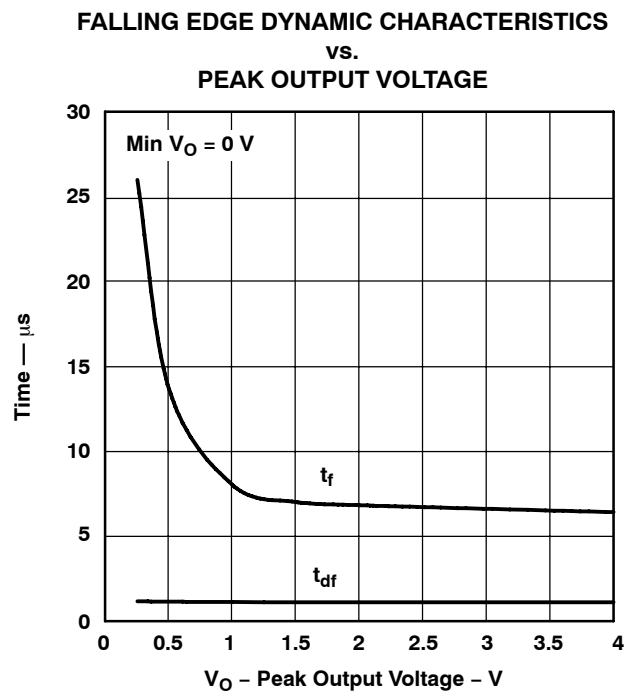

Figure 11

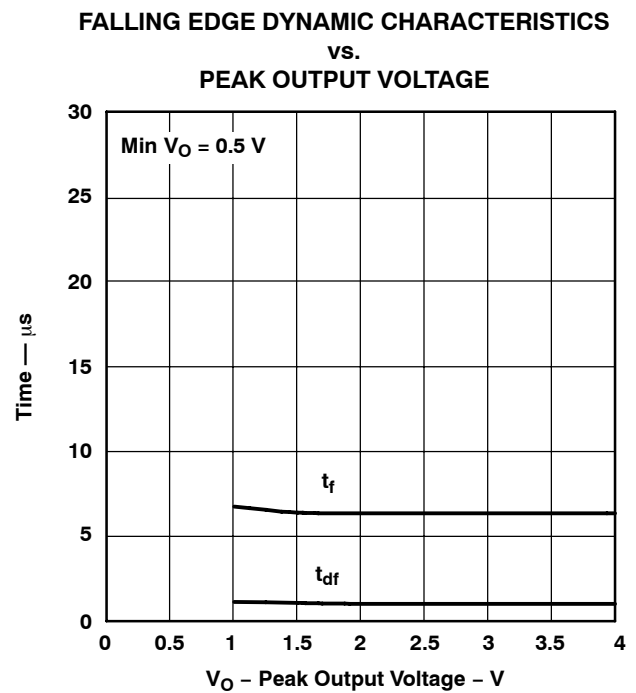

Figure 12

# TSL12T, TSL13T LIGHT-TO-VOLTAGE CONVERTERS

TAOS062D – APRIL 2007

## TYPICAL CHARACTERISTICS

### TSL13T

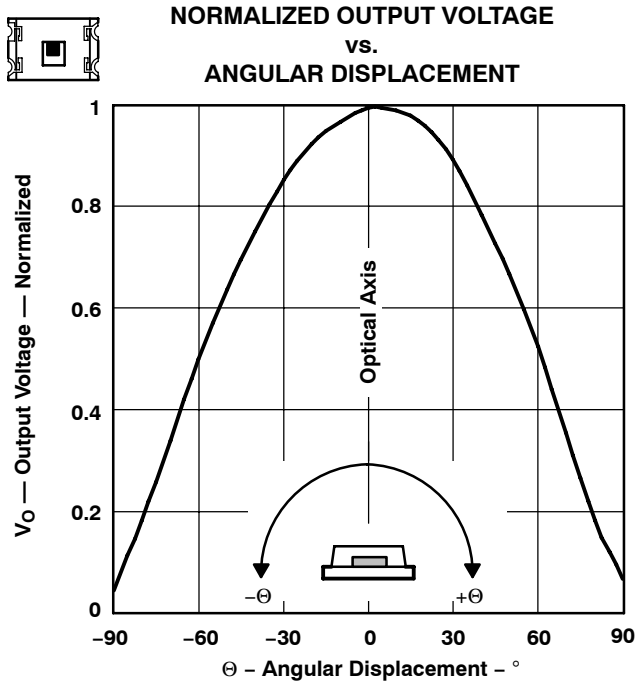

Figure 13

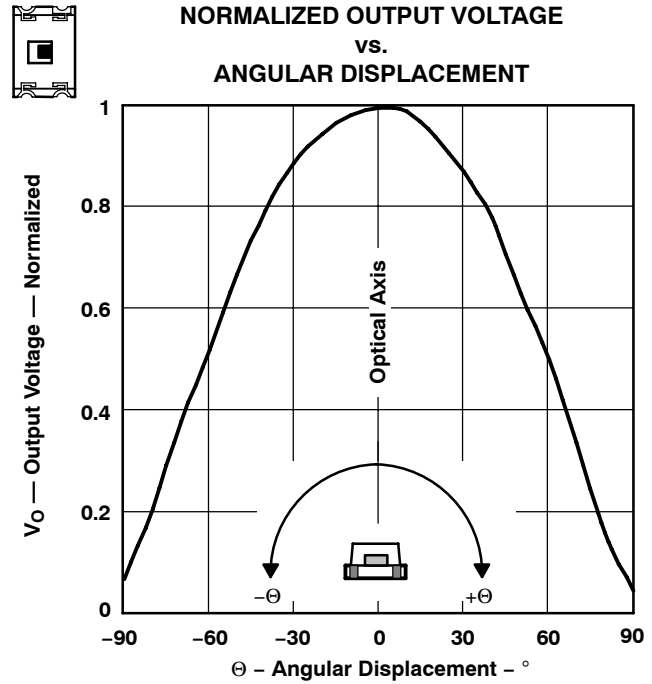

Figure 14



APPLICATION INFORMATION

PCB Pad Layout

Suggested PCB pad layout guidelines for the T package are shown in Figure 15.

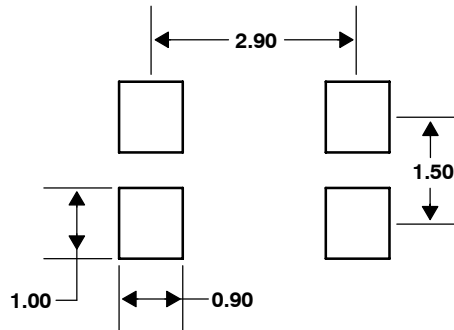

- NOTES: A. All linear dimensions are in millimeters.  
B. This drawing is subject to change without notice.

Figure 15. Suggested T Package PCB Layout

# TSL12T, TSL13T LIGHT-TO-VOLTAGE CONVERTERS

TAOS062D – APRIL 2007

## MECHANICAL DATA

The TSL12T and TSL13T are supplied in a low-profile surface-mount package. This package contains no lead (Pb).

### PACKAGE T

### Four-Lead Surface Mount Device

#### TOP VIEW

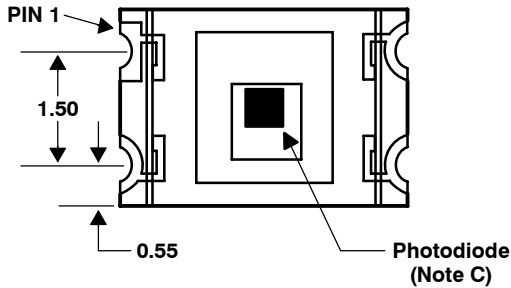

#### SIDE VIEW

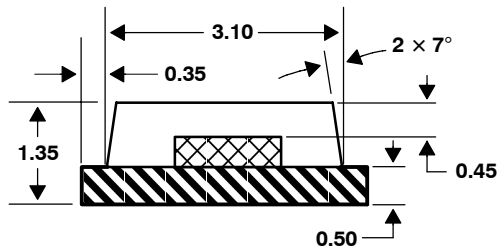

#### DETAIL A: TYPICAL PACKAGE TERMINAL

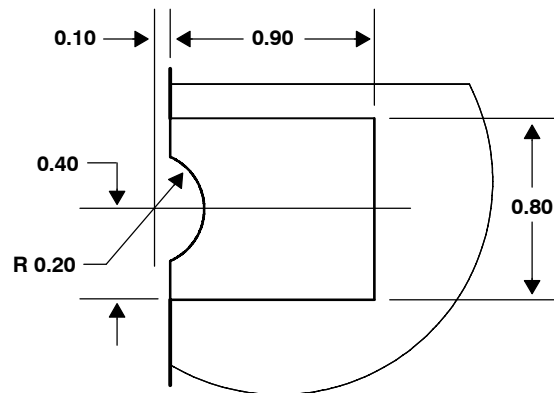

#### BOTTOM VIEW

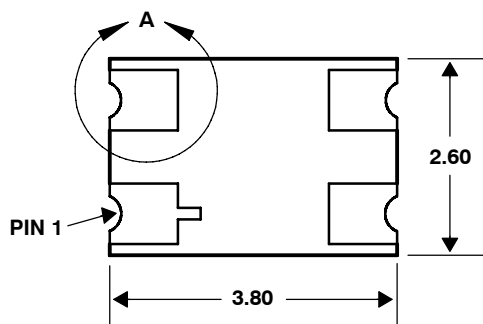

Lead Free

- NOTES: A. All linear dimensions are in millimeters.  
 B. Terminal finish is gold.  
 C. The center of the 0.50 mm x 0.50 mm integrated photodiode active area is typically located in the center of the package.  
 D. Dimension tolerance is  $\pm 0.15$  mm.  
 E. This drawing is subject to change without notice.

**Figure 16. Package T — Four-Lead Surface Mount Device Packaging Configuration**

MECHANICAL DATA

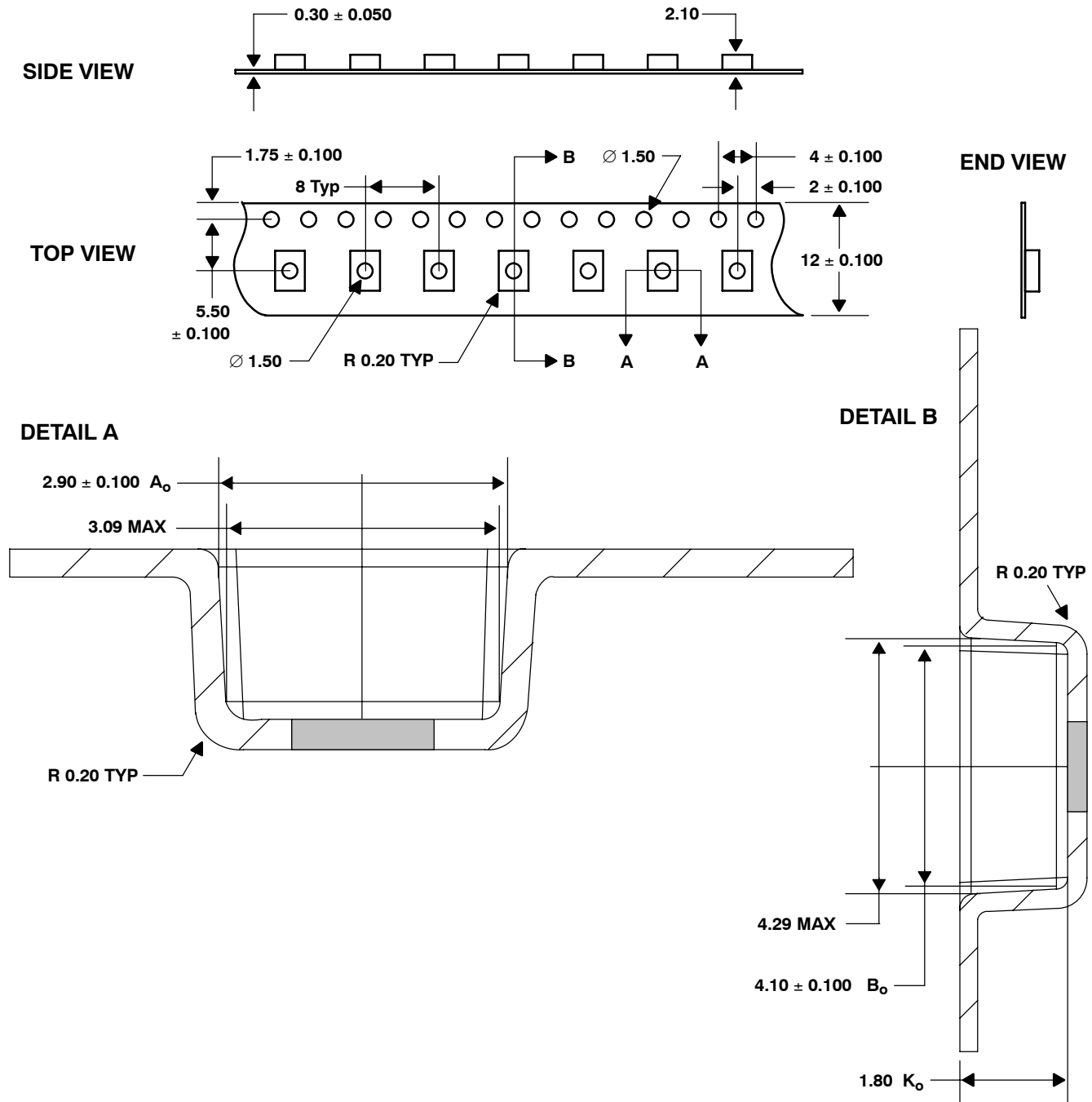

- NOTES: A. All linear dimensions are in millimeters.  
 B. The dimensions on this drawing are for illustrative purposes only. Dimensions of an actual carrier may vary slightly.  
 C. Symbols on drawing  $A_o$ ,  $B_o$ , and  $K_o$  are defined in ANSI EIA Standard 481-B 2001.  
 D. Each reel is 178 millimeters in diameter and contains 1000 parts.  
 E. TAOS packaging tape and reel conform to the requirements of EIA Standard 481-B.  
 F. In accordance with EIA standard, device pin 1 is located next to the sprocket holes in the tape.  
 G. This drawing is subject to change without notice.

Figure 17. Four Lead Surface Mount Package Carrier Tape

# TSL12T, TSL13T LIGHT-TO-VOLTAGE CONVERTERS

TAOS062D – APRIL 2007

## MANUFACTURING INFORMATION

The reflow profile specified here describes expected maximum heat exposure of devices during the solder reflow process of the device on a PWB. Temperature is measured at the top of the device. Devices should be limited to one pass through the solder reflow profile.

**Table 1. TSL12T, TSL13T Solder Reflow Profile**

PARAMETER	REFERENCE	TSL12T, TSL13T
Average temperature gradient in preheating		2.5°C/sec
Soak time	$t_{soak}$	2 to 3 minutes
Time above $T_1$ , 217°C	$t_1$	Max 60 sec
Time above $T_2$ , 230°C	$t_2$	Max 50 sec
Time above $T_3$ , ( $T_{peak} - 10^\circ\text{C}$ )	$t_3$	Max 10 sec
Peak temperature in reflow	$T_{peak}$	260° C (-0°C/+5°C)
Temperature gradient in cooling		Max -5°C/sec

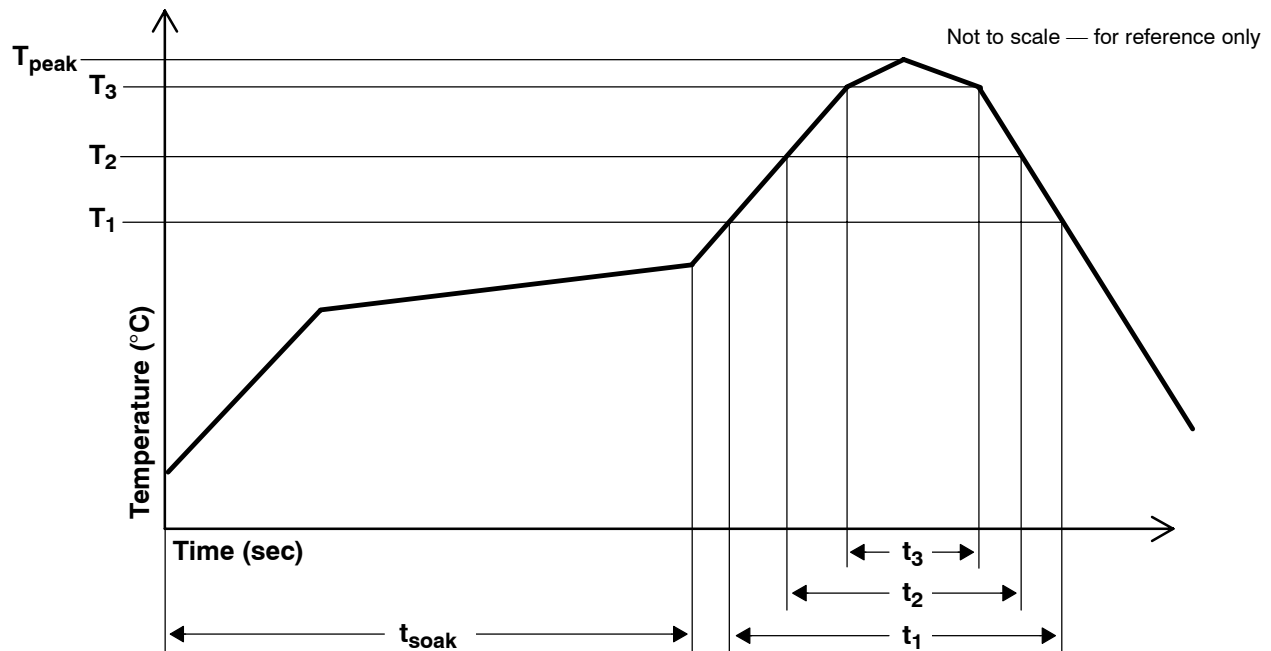

**Figure 18. TSL12T, TSL13T Solder Reflow Profile**

---

## MANUFACTURING INFORMATION

### Moisture Sensitivity

Optical characteristics of the device can be adversely affected during the soldering process by the release and vaporization of moisture that has been previously absorbed into the package molding compound. To ensure the package molding compound contains the smallest amount of absorbed moisture possible, each device is dry-baked prior to being packed for shipping. Devices are packed in a sealed aluminized envelope with silica gel to protect them from ambient moisture during shipping, handling, and storage before use.

This package has been assigned a moisture sensitivity level of MSL 3 and the devices should be stored under the following conditions:

Temperature Range	5°C to 50°C
Relative Humidity	60% maximum
Total Time	6 months from the date code on the aluminized envelope — if unopened
Opened Time	168 hours or fewer

Rebaking will be required if the devices have been stored unopened for more than 6 months or if the aluminized envelope has been open for more than 168 hours. If rebaking is required, it should be done at 90°C for 4 hours.

# TSL12T, TSL13T LIGHT-TO-VOLTAGE CONVERTERS

TAOS062D – APRIL 2007

---

**PRODUCTION DATA** — information in this document is current at publication date. Products conform to specifications in accordance with the terms of Texas Advanced Optoelectronic Solutions, Inc. standard warranty. Production processing does not necessarily include testing of all parameters.

## **LEAD-FREE (Pb-FREE) and GREEN STATEMENT**

**Pb-Free (RoHS)** TAOS' terms *Lead-Free* or *Pb-Free* mean semiconductor products that are compatible with the current RoHS requirements for all 6 substances, including the requirement that lead not exceed 0.1% by weight in homogeneous materials. Where designed to be soldered at high temperatures, TAOS Pb-Free products are suitable for use in specified lead-free processes.

**Green (RoHS & no Sb/Br)** TAOS defines *Green* to mean Pb-Free (RoHS compatible), and free of Bromine (Br) and Antimony (Sb) based flame retardants (Br or Sb do not exceed 0.1% by weight in homogeneous material).

**Important Information and Disclaimer** The information provided in this statement represents TAOS' knowledge and belief as of the date that it is provided. TAOS bases its knowledge and belief on information provided by third parties, and makes no representation or warranty as to the accuracy of such information. Efforts are underway to better integrate information from third parties. TAOS has taken and continues to take reasonable steps to provide representative and accurate information but may not have conducted destructive testing or chemical analysis on incoming materials and chemicals. TAOS and TAOS suppliers consider certain information to be proprietary, and thus CAS numbers and other limited information may not be available for release.

## **NOTICE**

Texas Advanced Optoelectronic Solutions, Inc. (TAOS) reserves the right to make changes to the products contained in this document to improve performance or for any other purpose, or to discontinue them without notice. Customers are advised to contact TAOS to obtain the latest product information before placing orders or designing TAOS products into systems.

TAOS assumes no responsibility for the use of any products or circuits described in this document or customer product design, conveys no license, either expressed or implied, under any patent or other right, and makes no representation that the circuits are free of patent infringement. TAOS further makes no claim as to the suitability of its products for any particular purpose, nor does TAOS assume any liability arising out of the use of any product or circuit, and specifically disclaims any and all liability, including without limitation consequential or incidental damages.

TEXAS ADVANCED OPTOELECTRONIC SOLUTIONS, INC. PRODUCTS ARE NOT DESIGNED OR INTENDED FOR USE IN CRITICAL APPLICATIONS IN WHICH THE FAILURE OR MALFUNCTION OF THE TAOS PRODUCT MAY RESULT IN PERSONAL INJURY OR DEATH. USE OF TAOS PRODUCTS IN LIFE SUPPORT SYSTEMS IS EXPRESSLY UNAUTHORIZED AND ANY SUCH USE BY A CUSTOMER IS COMPLETELY AT THE CUSTOMER'S RISK.

LUMENOLOGY, TAOS, the TAOS logo, and Texas Advanced Optoelectronic Solutions are registered trademarks of Texas Advanced Optoelectronic Solutions Incorporated.