

DATA SHEET

BGY135; BGY136 VHF power amplifier modules

Product specification
Supersedes data of June 1993
File under Discrete Semiconductors, SC09

1996 May 08

VHF power amplifier modules

BGY135; BGY136

FEATURES

- 12.5 V nominal supply voltage
- 18 W output power.

APPLICATIONS

- Mobile communication equipment operating directly from 12 V vehicle electrical systems.

DESCRIPTION

The BGY135 and BGY136 are two-stage broadband RF amplifier modules in a SOT132B package. Each module consists of two NPN transistor dies together with lumped-element matching components.

PINNING - SOT132B

PIN	DESCRIPTION
1	RF input
2	ground
3	V _{S1}
4	ground
5	V _{S2}
6	ground
7	RF output
Flange	ground

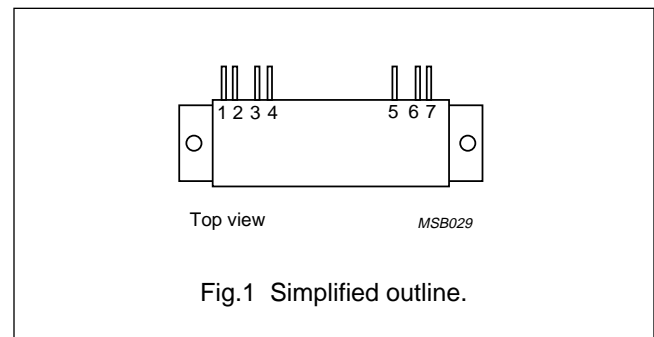

QUICK REFERENCE DATA

TYPE NUMBER	MODE OF OPERATION	f (MHz)	V _{S1} ; V _{S2} (V)	P _D (mW)	P _L (W)	Z _S ; Z _L (Ω)
BGY135	CW	132 to 156	12.5	150	≥18	50
BGY136	CW	146 to 174				

WARNING

Product and environmental safety - toxic materials

This product contains beryllium oxide. The product is entirely safe provided that the BeO inserts are not damaged. All persons who handle, use or dispose of this product should be aware of its nature and of the necessary safety precautions. After use, dispose of as chemical or special waste according to the regulations applying at the location of the user. It must never be thrown out with the general or domestic waste.

VHF power amplifier modules

BGY135; BGY136

LIMITING VALUES

In accordance with the Absolute Maximum Rating System (IEC 134).

SYMBOL	PARAMETER	MIN.	MAX.	UNIT
V_{S1}	DC supply voltage	–	15.6	V
V_{S2}	DC supply voltage	–	15.6	V
V_i	RF input voltage	–	25	V
V_o	RF output voltage	–	25	V
P_D	input drive power	–	300	mW
P_L	load power	–	25	W
T_{stg}	storage temperature	–40	+100	°C
T_h	heatsink operating temperature	–20	+90	°C

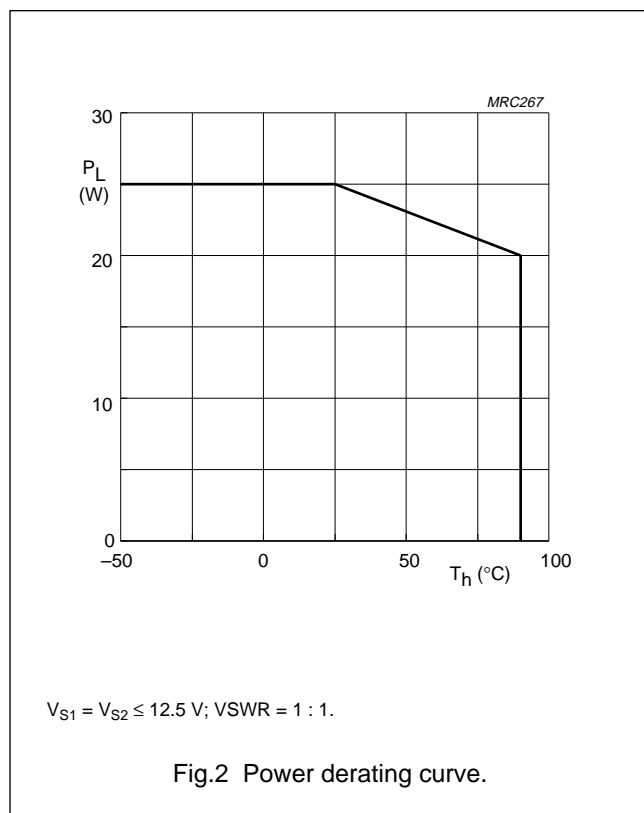

VHF power amplifier modules

BGY135; BGY136

CHARACTERISTICS

$Z_S = Z_L = 50 \Omega$; $P_D = 150 \text{ mW}$; $V_{S1} = V_{S2} = 12.5 \text{ V}$; $T_h = 25 \text{ }^\circ\text{C}$; unless otherwise specified.

SYMBOL	PARAMETER	CONDITIONS	MIN.	TYP.	MAX.	UNIT
f	frequency					
	BGY135		132	–	156	MHz
	BGY136		146	–	174	MHz
I_{Q2}	leakage current	$V_{S1} = 0$; $P_D = 0$	–	–	1	mA
P_L	load power		18	–	–	W
η	efficiency	adjust P_D for $P_L = 18 \text{ W}$	38	45	–	%
H_2	second harmonic	adjust P_D for $P_L = 18 \text{ W}$	–	–	–25	dBc
H_3	third harmonic	adjust P_D for $P_L = 18 \text{ W}$	–	–	–25	dBc
$V_{SWR_{in}}$	input VSWR	adjust P_D for $P_L = 18 \text{ W}$	–	1.5	3	
	stability	$V_{S1} = V_{S2} = 10.8 \text{ to } 15.6 \text{ V}$; $P_L = 2 \text{ to } 20 \text{ W}$; $V_{SWR} = 3 : 1$	–	–	–60	dBc
	ruggedness	$P_D \leq 300 \text{ mW}$; $V_{S1} = V_{S2} = 15.6 \text{ V}$ duration 5 s; $P_L < 25 \text{ W}$; $V_{SWR} = 50 : 1$	no degradation			

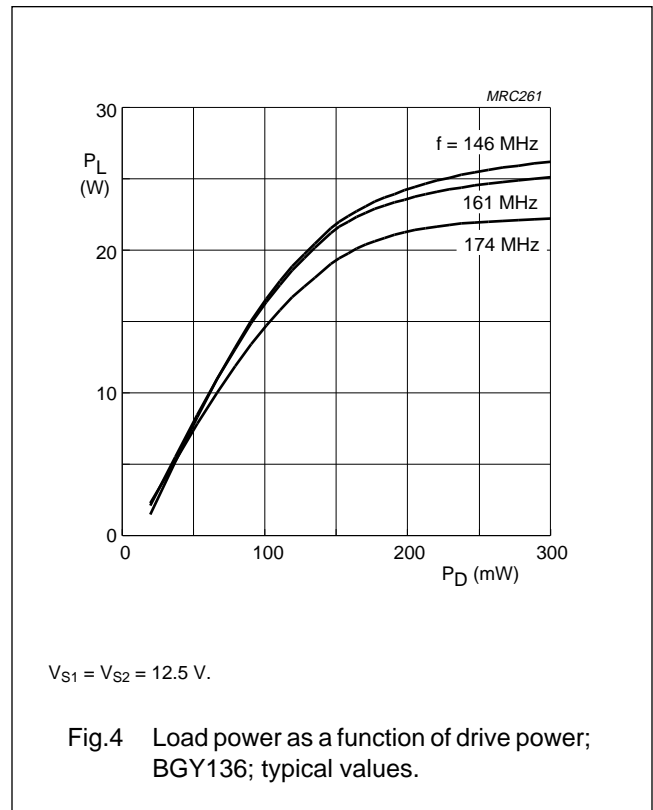
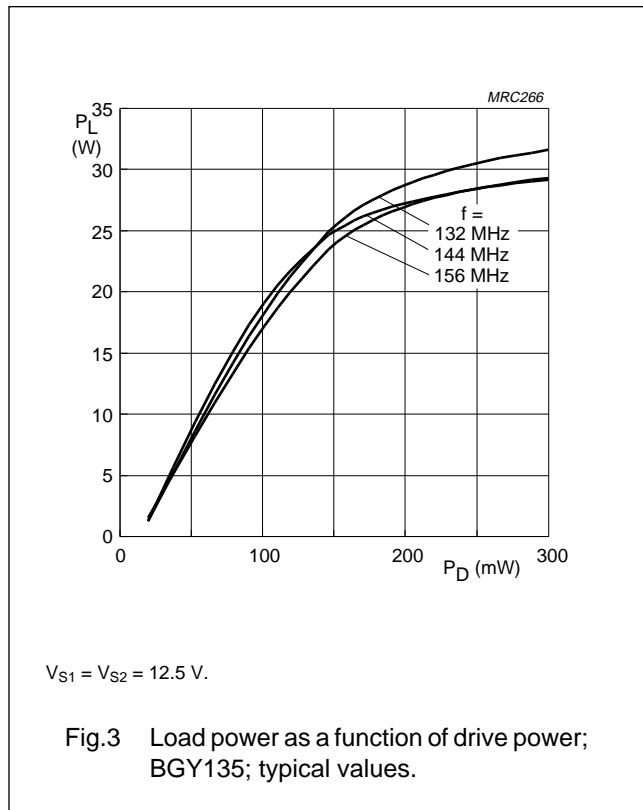

VHF power amplifier modules

BGY135; BGY136

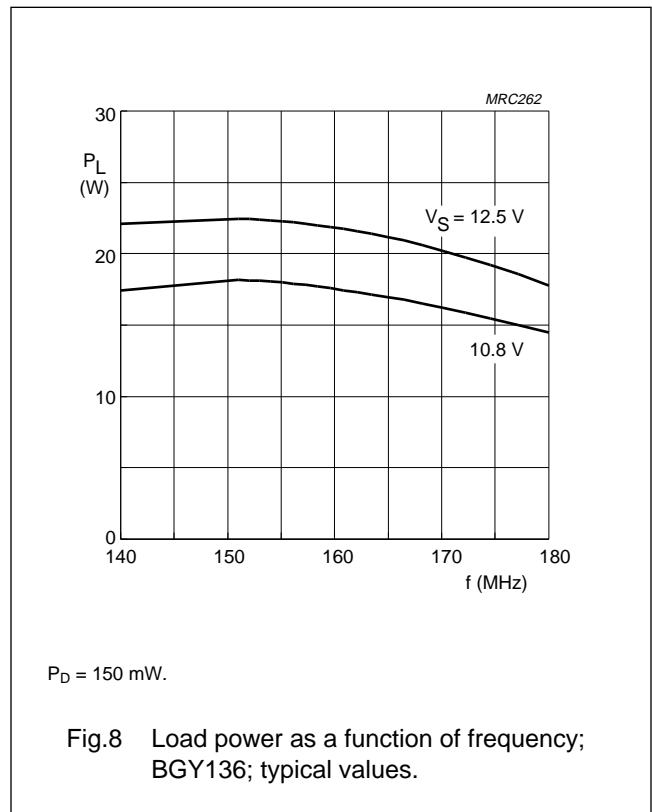
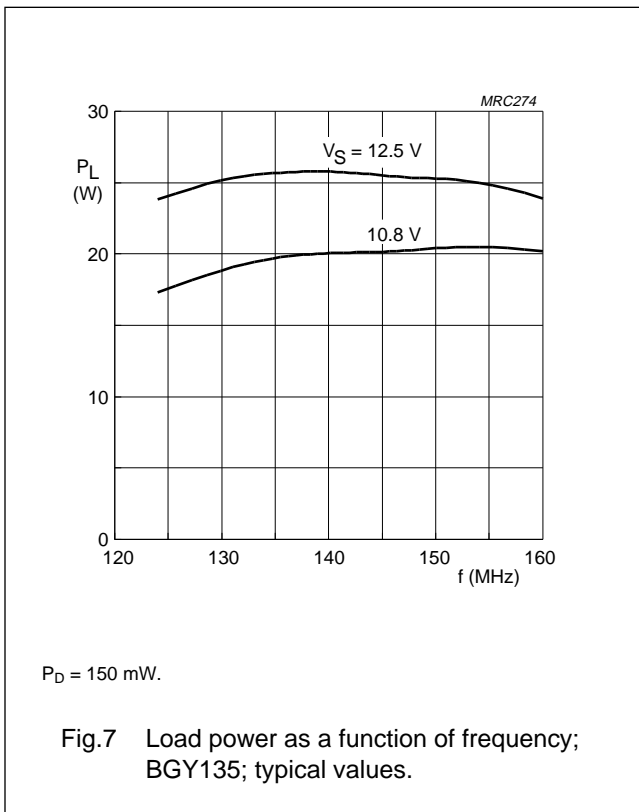
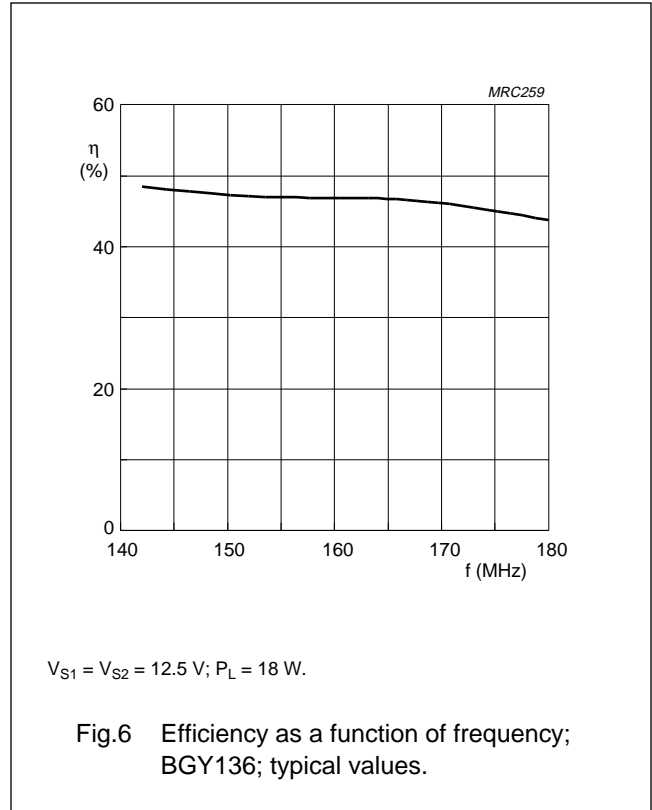
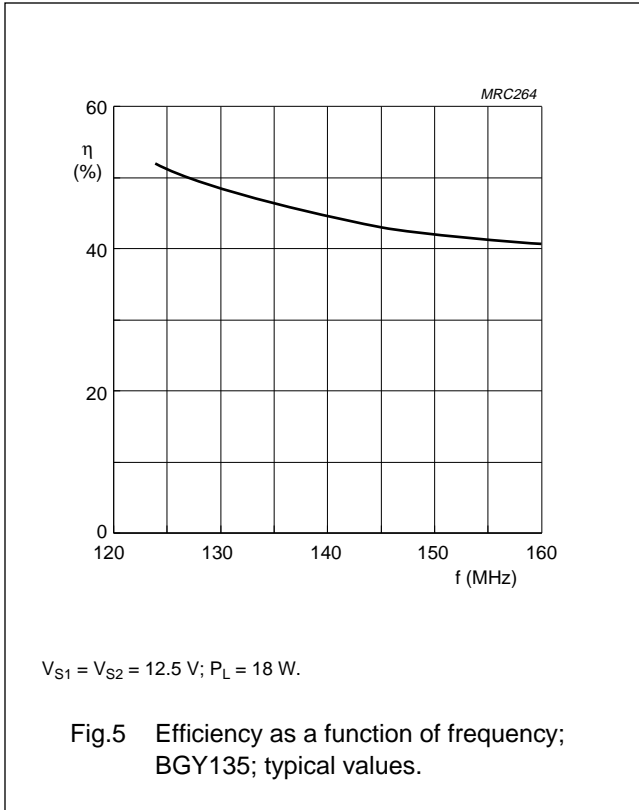

VHF power amplifier modules

BGY135; BGY136

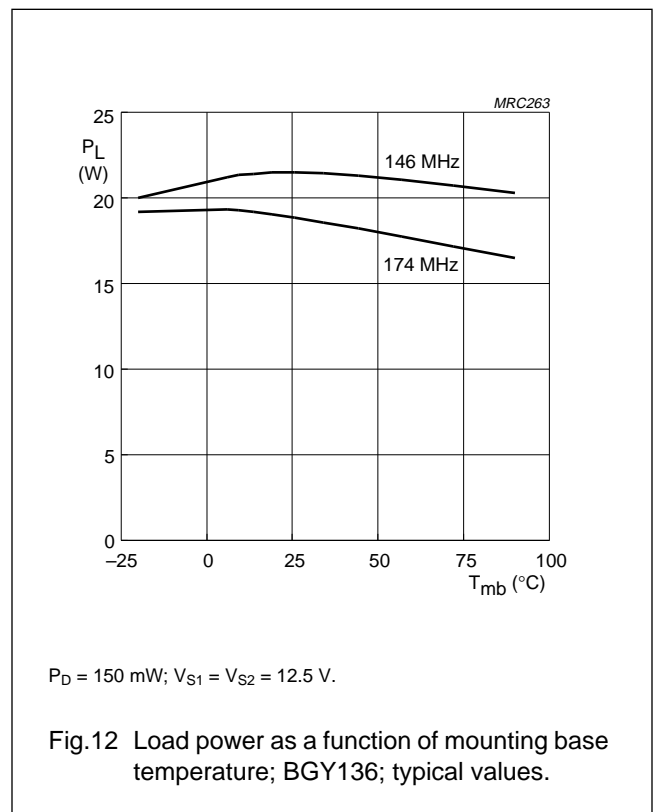
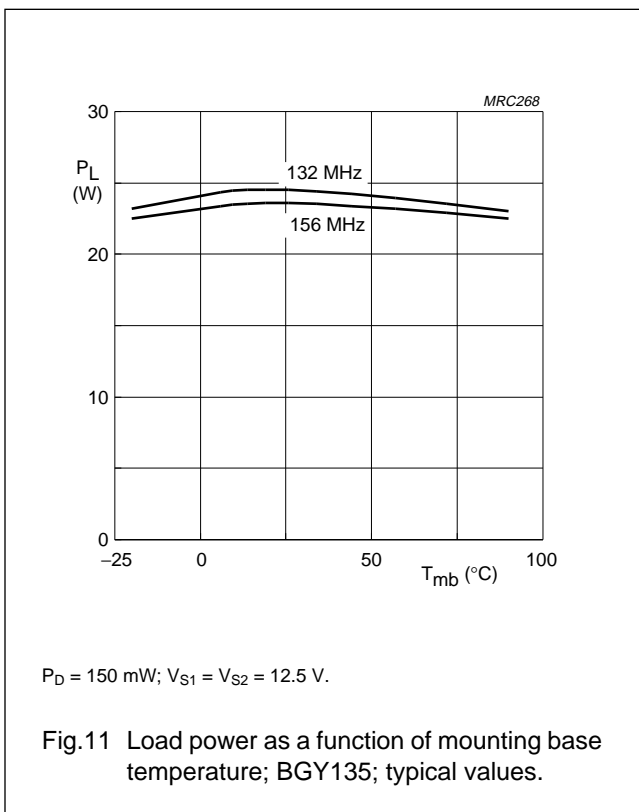
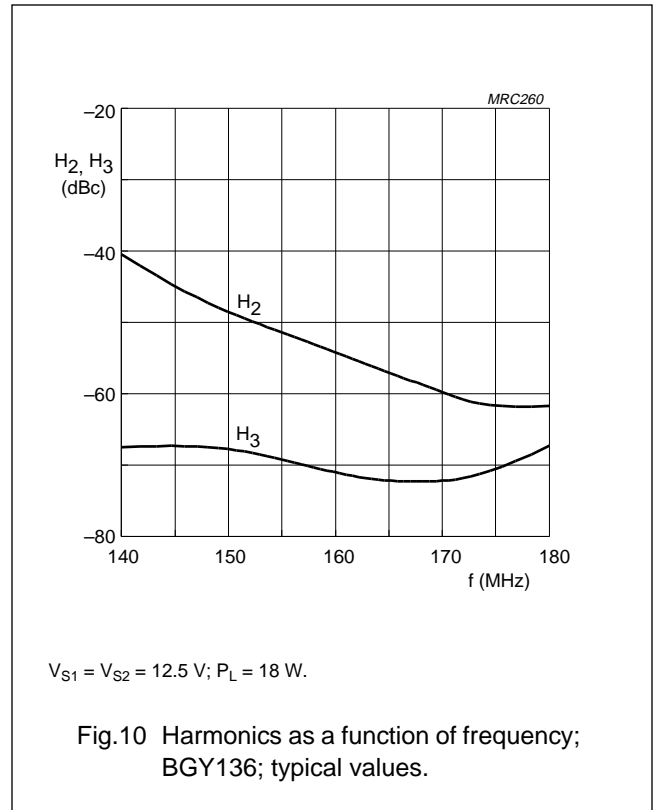
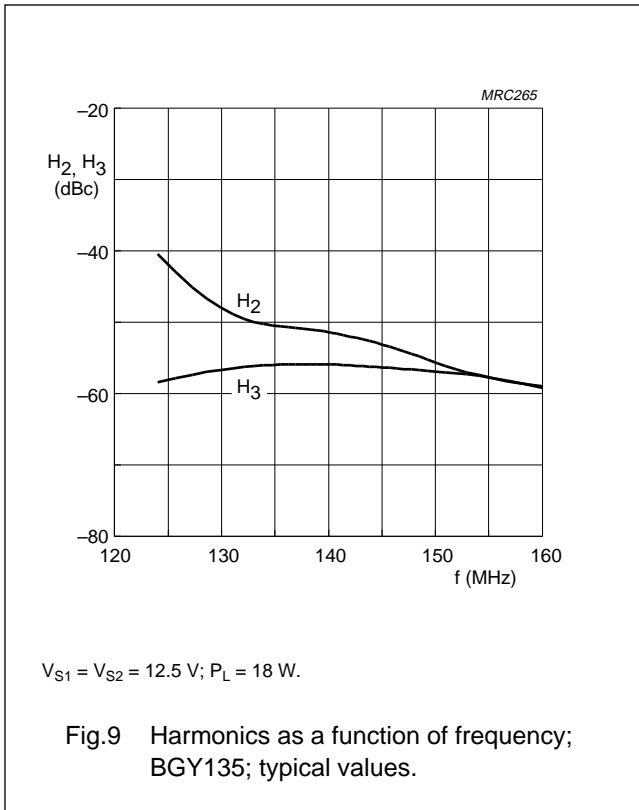

VHF power amplifier modules

BGY135; BGY136

Test circuit information

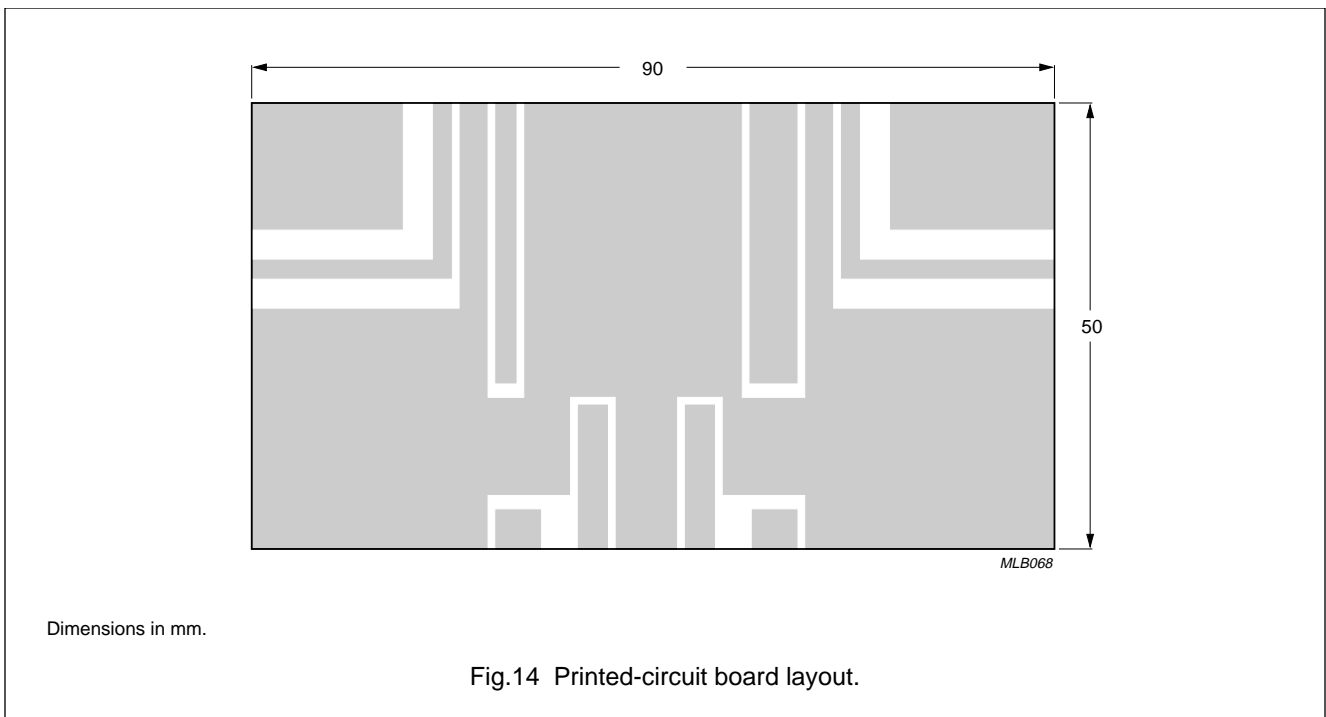
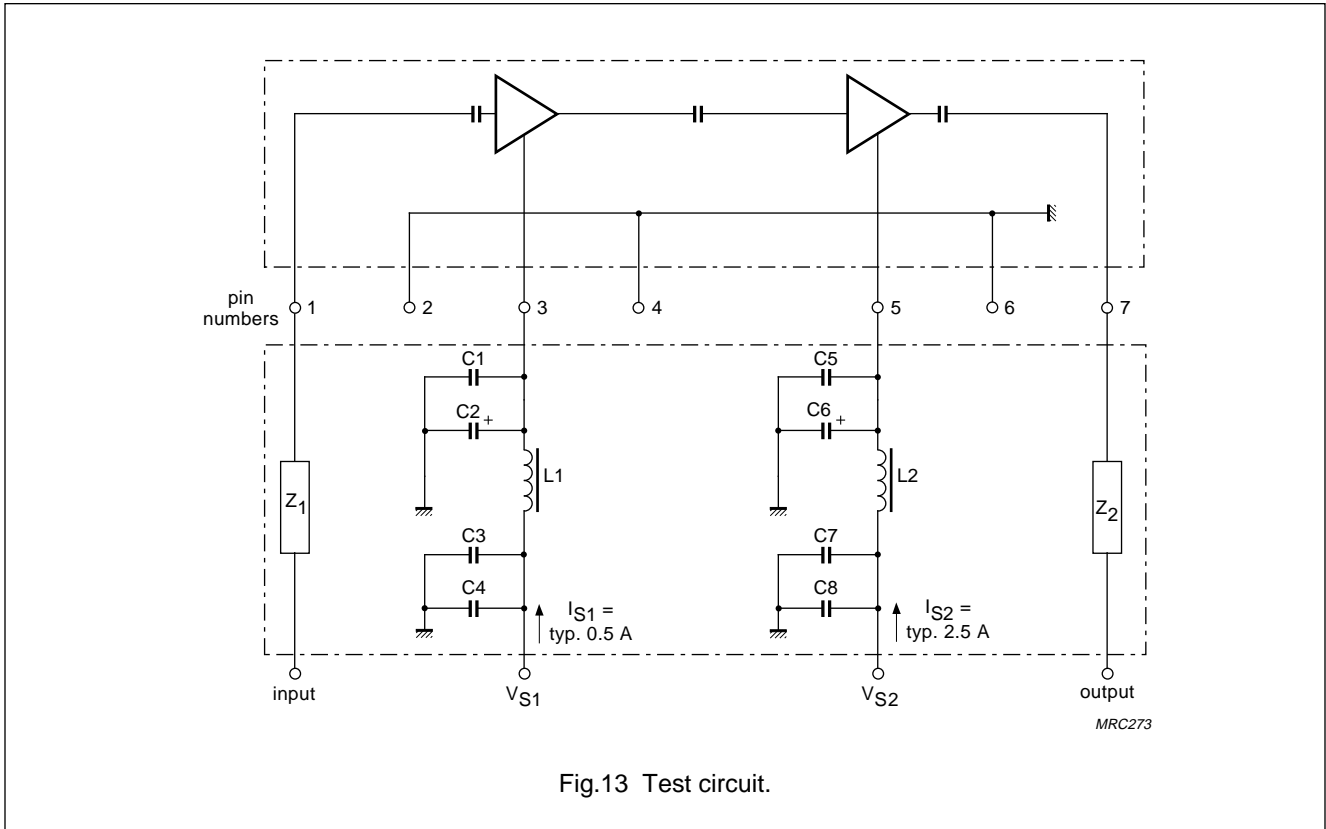

VHF power amplifier modules

BGY135; BGY136

List of components (see Fig.13)

COMPONENT	DESCRIPTION	VALUE	CATALOGUE NO
C1, C5	multilayer chip capacitor	1 nF	4822 590 06614
C2, C6	tantalum capacitor	6.8 μ F, 35 V	2022 001 00067
C3, C7	multilayer chip capacitor	10 nF	2222 852 47103
C4, C8	multilayer chip capacitor	100 nF	2222 852 47104
L1, L2	1 turn 0.5 mm copper wire on ferrite coil	1 μ H	3122 108 20153
Z ₁ , Z ₂	stripline; note 1	50 Ω	

Note

1. The striplines are on a double copper-clad printed-circuit board, with epoxy dielectric ($\epsilon_r = 4.7$), thickness $\frac{1}{16}$ inch.

VHF power amplifier modules

BGY135; BGY136

PACKAGE OUTLINE

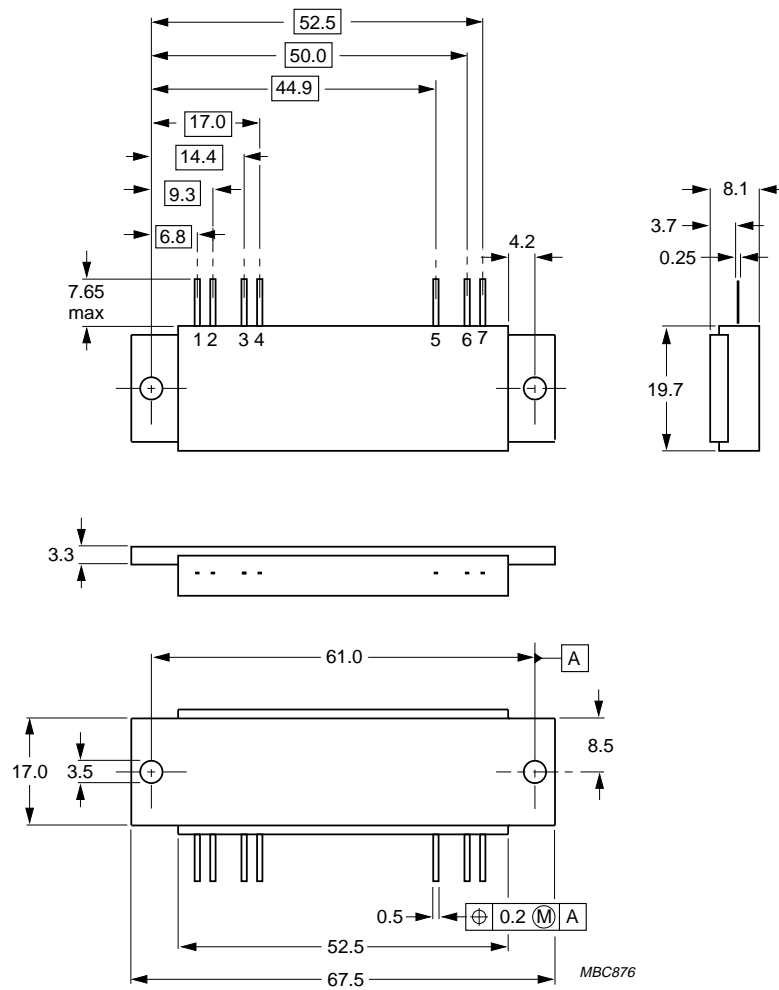

Dimensions in mm.

Fig.15 SOT132B.

VHF power amplifier modules

BGY135; BGY136

DEFINITIONS

Data sheet status	
Objective specification	This data sheet contains target or goal specifications for product development.
Preliminary specification	This data sheet contains preliminary data; supplementary data may be published later.
Product specification	This data sheet contains final product specifications.
Limiting values	
Limiting values given are in accordance with the Absolute Maximum Rating System (IEC 134). Stress above one or more of the limiting values may cause permanent damage to the device. These are stress ratings only and operation of the device at these or at any other conditions above those given in the Characteristics sections of the specification is not implied. Exposure to limiting values for extended periods may affect device reliability.	
Application information	
Where application information is given, it is advisory and does not form part of the specification.	

LIFE SUPPORT APPLICATIONS

These products are not designed for use in life support appliances, devices, or systems where malfunction of these products can reasonably be expected to result in personal injury. Philips customers using or selling these products for use in such applications do so at their own risk and agree to fully indemnify Philips for any damages resulting from such improper use or sale.