

1.5GHz to 3.8GHz High Linearity Upconverting Mixer

FEATURES

- High Output IP3: +27.3dBm at 2.14GHz
- Low Noise Floor: -158dBm/Hz ($P_{OUT} = -5dBm$)
- High Conversion Gain: 2.6dB at 2.14GHz
- Wide Frequency Range: 1.5GHz to 3.8GHz*
- Low LO Leakage
- Single-Ended RF and LO
- Low LO Drive Level: -1dBm
- Single 3.3V Supply
- 5mm × 5mm QFN24 Package

APPLICATIONS

- GSM/EDGE, W-CDMA, UMTS, LTE and TD-SCDMA Basestations
- 2.6GHz and 3.5GHz WiMAX Basestations
- 2.4GHz ISM Band Transmitters
- High Performance Transmitters

LT, LT, LTC and LTM are registered trademarks of Linear Technology Corporation. All other trademarks are the property of their respective owners.

*Operation over wider frequency range is possible with reduced performance. Consult Linear Technology for information and assistance.

DESCRIPTION

The LT[®]5579 mixer is a high performance upconverting mixer optimized for frequencies in the 1.5GHz to 3.8GHz range. The single-ended LO input and RF output ports simplify board layout and reduce system cost. The mixer needs only -1dBm of LO power and the balanced design results in low LO signal leakage to the RF output. At 2.6GHz operation, the LT5579 provides high conversion gain of 1.3dB, high OIP3 of +26dBm and a low noise floor of -157.5dBm/Hz at a -5dBm RF output signal level.

The LT5579 offers a high performance alternative to passive mixers. Unlike passive mixers, which have conversion loss and require high LO drive levels, the LT5579 delivers conversion gain at significantly lower LO input levels and is less sensitive to LO power level variations. The lower LO drive level requirements, combined with the excellent LO leakage performance, translate into lower LO signal contamination of the output signal.

TYPICAL APPLICATION

Frequency Upconversion in 2.14GHz W-CDMA Transmitter

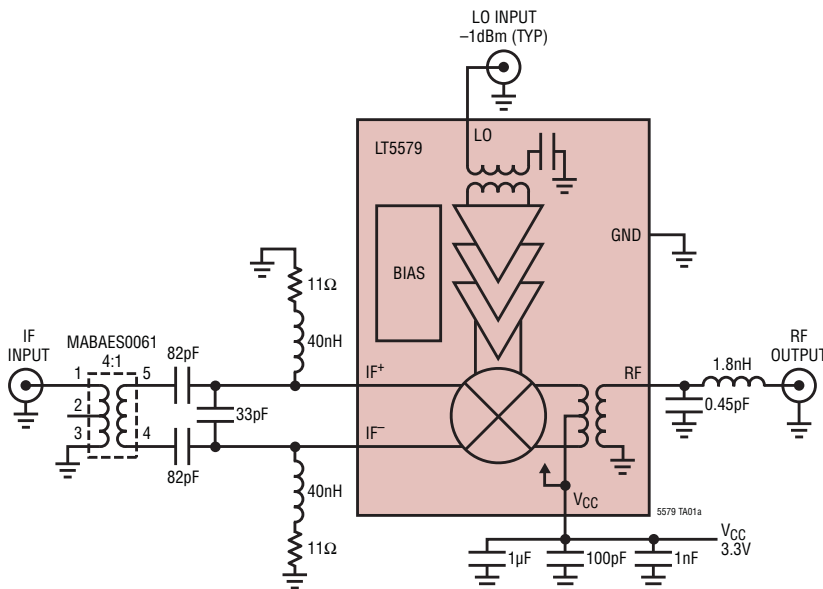

Gain, NF and OIP3 vs
RF Output Frequency

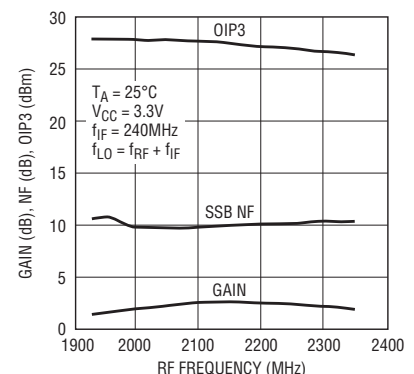

ABSOLUTE MAXIMUM RATINGS

(Note 1)

Supply Voltage	3.6V
LO Input Power	+10dBm
LO Input DC Voltage	-0.3V to $V_{CC} + 0.3V$
RF Output DC Current	60mA
IF Input Power (Differential).....	+13dBm
IF ⁺ , IF ⁻ DC Currents	60mA
T _{JMAX}	150°C
Operating Temperature Range.....	-40°C to 85°C
Storage Temperature Range.....	-65°C to 150°C

PIN CONFIGURATION

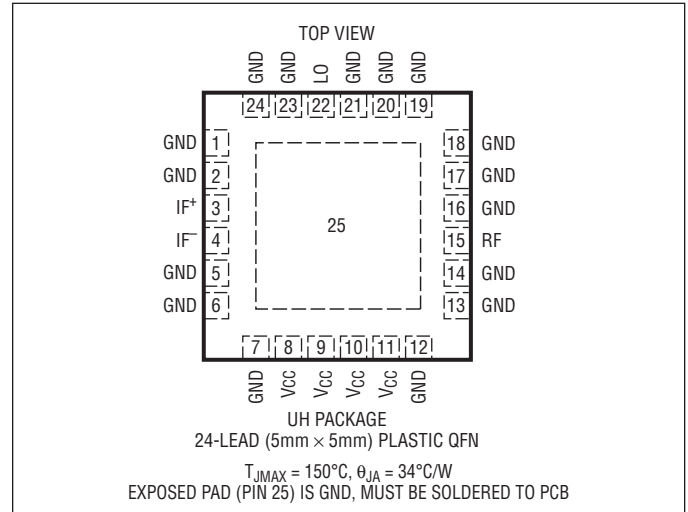

ORDER INFORMATION

LEAD FREE FINISH	TAPE AND REEL	PART MARKING	PACKAGE DESCRIPTION	TEMPERATURE RANGE
LT5579IUH#PBF	LT5579IUH#TRPBF	5579	24-Lead (5mm × 5mm) Plastic QFN	-40°C to 85°C

Consult LTC Marketing for parts specified with wider operating temperature ranges.

Consult LTC Marketing for information on non-standard lead based finish parts.

For more information on lead free part marking, go to: <http://www.linear.com/leadfree/>

For more information on tape and reel specifications, go to: <http://www.linear.com/tapeandreel/>

DC ELECTRICAL CHARACTERISTICS $V_{CC} = 3.3V$, $T_A = 25^\circ C$ (Note 3), unless otherwise noted.

PARAMETER	CONDITIONS	MIN	TYP	MAX	UNITS
Power Supply Requirements (V_{CC})					
Supply Voltage		3.15	3.3	3.6	V_{DC}
Supply Current	$V_{CC} = 3.3V$, $P_{LO} = -1dBm$		226	250	mA
	$V_{CC} = 3.6V$, $P_{LO} = -1dBm$		241		mA
Input Common Mode Voltage (V_{CM})	Internally Regulated		570		mV

AC ELECTRICAL CHARACTERISTICS (Notes 2, 3)

PARAMETER	CONDITIONS	MIN	TYP	MAX	UNITS
IF Input Frequency Range (Note 4)	Requires Matching		LF to 1000		MHz
LO Input Frequency Range (Note 4)	Requires Matching Below 1GHz		750 to 4300		MHz
RF Output Frequency Range (Note 4)	Requires Matching		900 to 3900		MHz

AC ELECTRICAL CHARACTERISTICS $V_{CC} = 3.3V$, $T_A = 25^\circ C$, $P_{RF} = -5dBm$ (-5dBm/tone for 2-tone tests, $\Delta f = 1MHz$), $P_{LO} = -1dBm$, unless otherwise noted. Test circuits are shown in Figure 1. (Notes 2, 3)

PARAMETER	CONDITIONS	MIN	TYP	MAX	UNITS
IF Input Return Loss	$Z_0 = 50\Omega$, External Match		15		dB
LO Input Return Loss	$Z_0 = 50\Omega$, 1100MHz to 4000MHz		>9		dB
RF Output Return Loss	$Z_0 = 50\Omega$, External Match		>10		dB
LO Input Power			-5 to 2		dBm

$V_{CC} = 3.3V$, $T_A = 25^\circ C$, $P_{RF} = -5dBm$ (-5dBm/tone for 2-tone tests, $\Delta f = 1MHz$), $P_{LO} = -1dBm$, unless otherwise noted. Low side LO for 1750MHz and 3600MHz. High side LO for 2140MHz and 2600MHz. (Notes 2, 3, 4)

PARAMETER	CONDITIONS	MIN	TYP	MAX	UNITS
Conversion Gain	$f_{IF} = 240MHz$, $f_{RF} = 1750MHz$		1.8		dB
	$f_{IF} = 240MHz$, $f_{RF} = 2140MHz$		2.6		dB
	$f_{IF} = 456MHz$, $f_{RF} = 2600MHz$		1.3		dB
	$f_{IF} = 456MHz$, $f_{RF} = 3600MHz$		-0.5		dB
Conversion Gain vs Temperature ($T_A = -40^\circ C$ to $85^\circ C$)	$f_{IF} = 240MHz$, $f_{RF} = 1750MHz$		-0.020		dB/ $^\circ C$
	$f_{IF} = 240MHz$, $f_{RF} = 2140MHz$		-0.020		dB/ $^\circ C$
	$f_{IF} = 456MHz$, $f_{RF} = 2600MHz$		-0.027		dB/ $^\circ C$
	$f_{IF} = 456MHz$, $f_{RF} = 3600MHz$		-0.027		dB/ $^\circ C$
Output 3rd Order Intercept	$f_{IF} = 240MHz$, $f_{RF} = 1750MHz$		29		dBm
	$f_{IF} = 240MHz$, $f_{RF} = 2140MHz$		27.3		dBm
	$f_{IF} = 456MHz$, $f_{RF} = 2600MHz$		26.2		dBm
	$f_{IF} = 456MHz$, $f_{RF} = 3600MHz$		23.2		dBm
Output 2nd Order Intercept	$f_{IF} = 240MHz$, $f_{RF} = 1750MHz$		41		dBm
	$f_{IF} = 240MHz$, $f_{RF} = 2140MHz$		42		dBm
	$f_{IF} = 456MHz$, $f_{RF} = 2600MHz$		45		dBm
	$f_{IF} = 456MHz$, $f_{RF} = 3600MHz$		54		dBm
Single Sideband Noise Figure	$f_{IF} = 240MHz$, $f_{RF} = 1750MHz$		9.2		dB
	$f_{IF} = 240MHz$, $f_{RF} = 2140MHz$		9.9		dB
	$f_{IF} = 456MHz$, $f_{RF} = 2600MHz$		12		dB
	$f_{IF} = 456MHz$, $f_{RF} = 3600MHz$		12		dB
Output Noise Floor ($P_{OUT} = -5dBm$)	$f_{IF} = 240MHz$, $f_{RF} = 1750MHz$		-159.5		dBm/Hz
	$f_{IF} = 240MHz$, $f_{RF} = 2140MHz$		-158.1		dBm/Hz
	$f_{IF} = 456MHz$, $f_{RF} = 2600MHz$		-157.5		dBm/Hz
	$f_{IF} = 456MHz$, $f_{RF} = 3600MHz$		-155.5		dBm/Hz
Output 1dB Compression	$f_{IF} = 240MHz$, $f_{RF} = 1750MHz$		13.3		dBm
	$f_{IF} = 240MHz$, $f_{RF} = 2140MHz$		13.9		dBm
	$f_{IF} = 456MHz$, $f_{RF} = 2600MHz$		13.7		dBm
	$f_{IF} = 456MHz$, $f_{RF} = 3600MHz$		10.7		dBm
IF to LO Isolation	$f_{IF} = 240MHz$, $f_{RF} = 1750MHz$		83		dB
	$f_{IF} = 240MHz$, $f_{RF} = 2140MHz$		81		dB
	$f_{IF} = 456MHz$, $f_{RF} = 2600MHz$		74		dB
	$f_{IF} = 456MHz$, $f_{RF} = 3600MHz$		73		dB
LO to IF Leakage	$f_{IF} = 240MHz$, $f_{RF} = 1750MHz$		-23		dBm
	$f_{IF} = 240MHz$, $f_{RF} = 2140MHz$		-28		dBm
	$f_{IF} = 456MHz$, $f_{RF} = 2600MHz$		-26		dBm
	$f_{IF} = 456MHz$, $f_{RF} = 3600MHz$		-22		dBm
LO to RF Leakage	$f_{IF} = 240MHz$, $f_{RF} = 1750MHz$		-39		dBm
	$f_{IF} = 240MHz$, $f_{RF} = 2140MHz$		-35		dBm
	$f_{IF} = 456MHz$, $f_{RF} = 2600MHz$		-36		dBm
	$f_{IF} = 456MHz$, $f_{RF} = 3600MHz$		-35		dBm

Note 1: Stresses beyond those listed under Absolute Maximum Ratings may cause permanent damage to the device. Exposure to any Absolute Maximum Rating condition for extended periods may affect device reliability and lifetime.

Note 2: Each set of frequency conditions requires appropriate matching (see Figure 1).

Note 3: The LT5579 is guaranteed to meet specified performance from $-40^\circ C$ to $85^\circ C$

Note 4: SSB noise figure measurements performed with a small-signal noise source and bandpass filter on LO signal generator. No other IF signal applied.

TYPICAL DC PERFORMANCE CHARACTERISTICS (Test Circuit Shown in Figure 1)

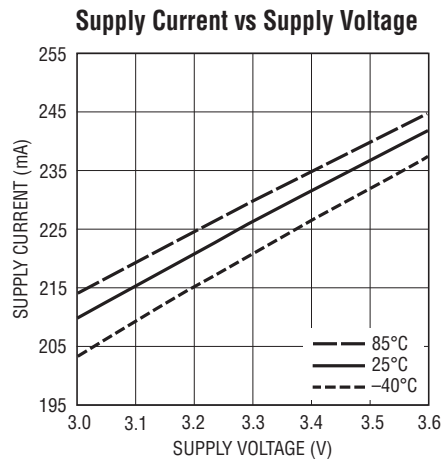

5579 G01

TYPICAL AC PERFORMANCE CHARACTERISTICS 3300MHz to 3800MHz Application:

$V_{CC} = 3.3V$, $T_A = 25^\circ C$, $f_{IF} = 456MHz$, $P_{IF} = -5dBm$ (-5dBm/tone for 2-tone tests, $\Delta f = 1MHz$), low side LO, $P_{LO} = -1dBm$, output measured at 3600MHz, unless otherwise noted. (Test circuit shown in Figure 1)

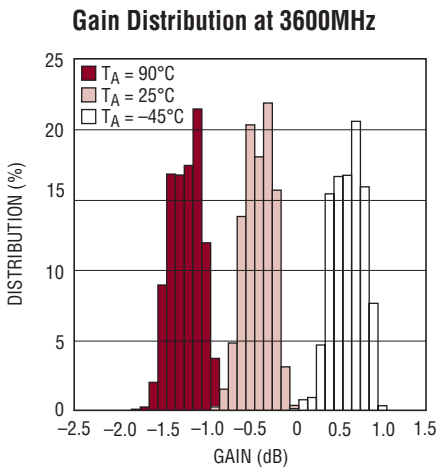

5579 G02

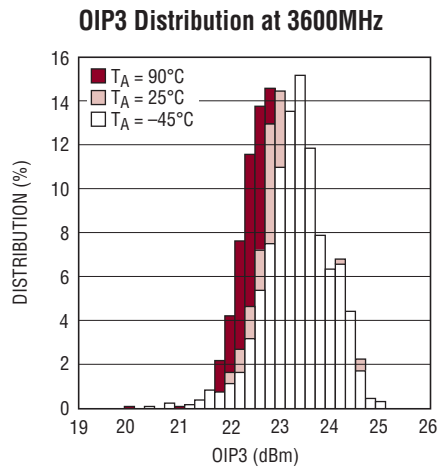

5579 G03

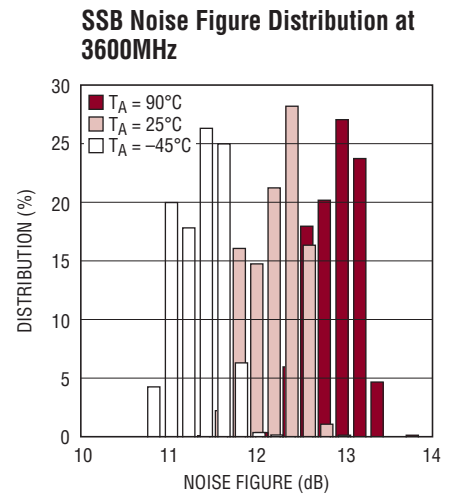

5579 G04

TYPICAL AC PERFORMANCE CHARACTERISTICS 3300MHz to 3800MHz Application:
 $V_{CC} = 3.3V$, $T_A = 25^\circ C$, $f_{IF} = 456MHz$, $P_{IF} = -5dBm$ (-5dBm/tone for 2-tone tests, $\Delta f = 1MHz$), low side LO, $P_{LO} = -1dBm$,
 output measured at 3600MHz, unless otherwise noted. (Test circuit shown in Figure 1)

Conversion Gain and OIP3 vs RF Output Frequency

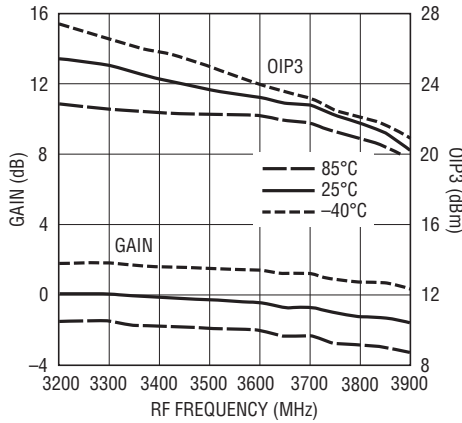

5579 G05

SSB Noise Figure vs RF Output Frequency

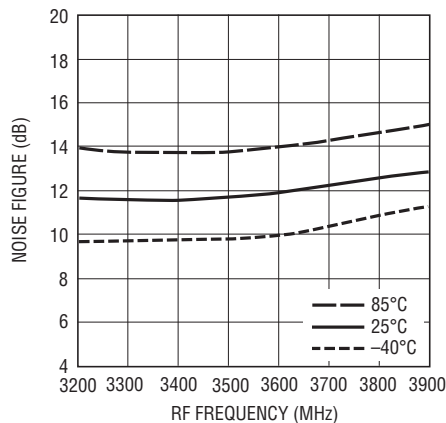

5579 G06

LO-RF Leakage vs RF Output Frequency

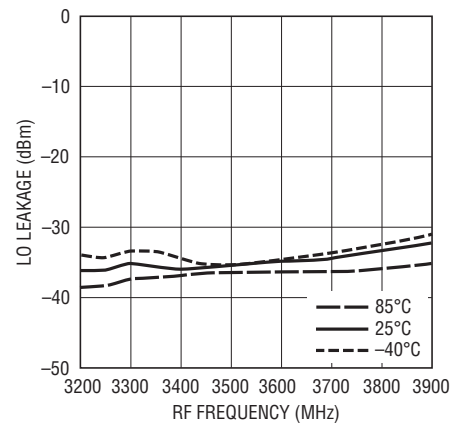

5579 G07

Conversion Gain and OIP3 vs LO Input Power

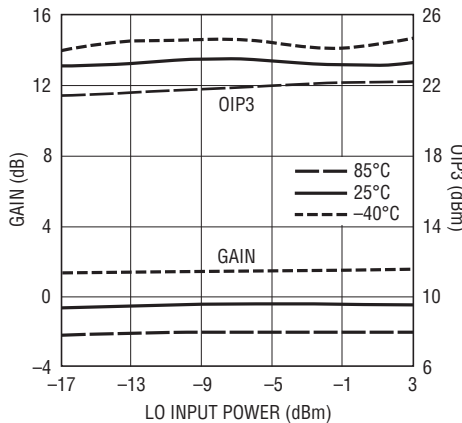

5579 G08

SSB Noise Figure vs LO Input Power

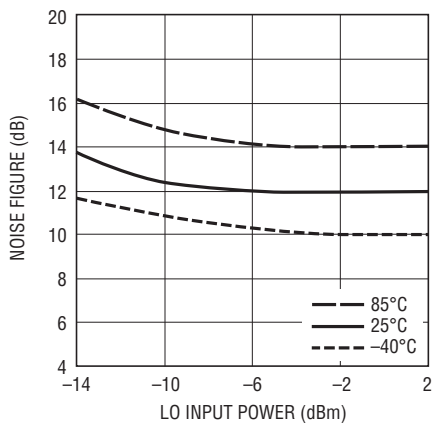

5579 G09

Conversion Gain and OIP3 vs Supply Voltage

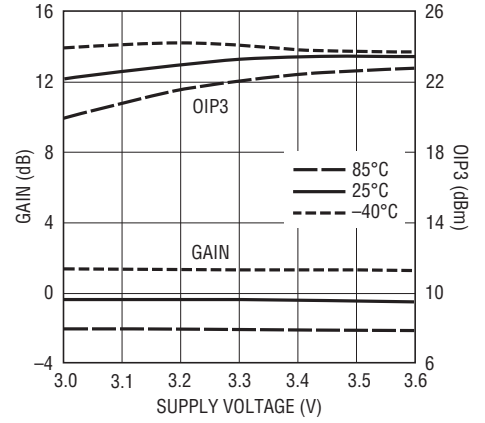

5579 G10

IM3 Level vs RF Output Power (2-Tone)

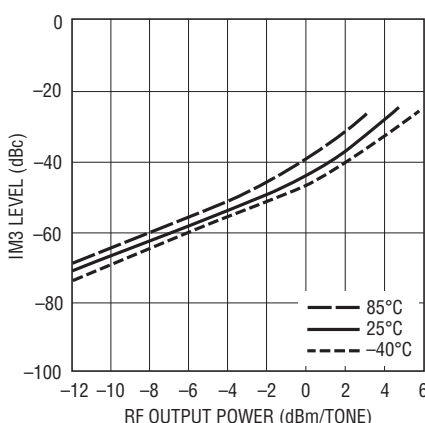

5579 G11

IM2 Level vs RF Output Power (2-Tone)

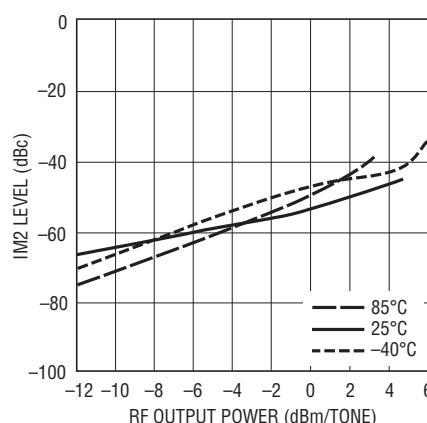

5579 G12

SSB Noise Figure vs Supply Voltage

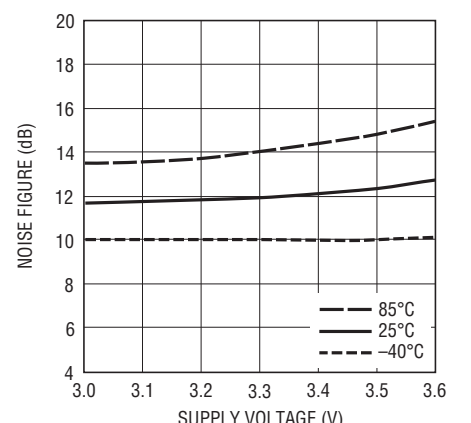

5579 G13

TYPICAL AC PERFORMANCE CHARACTERISTICS 2300MHz to 2700MHz Application:
 $V_{CC} = 3.3V$, $T_A = 25^\circ C$, $f_{IF} = 456MHz$, $P_{IF} = -5dBm$ (-5dBm/tone for 2-tone tests, $\Delta f = 1MHz$), high side LO, $P_{LO} = -1dBm$,
 output measured at 2600MHz, unless otherwise noted. (Test circuit shown in Figure 1)

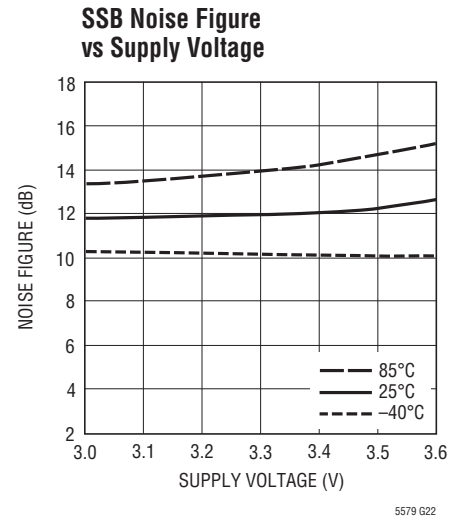
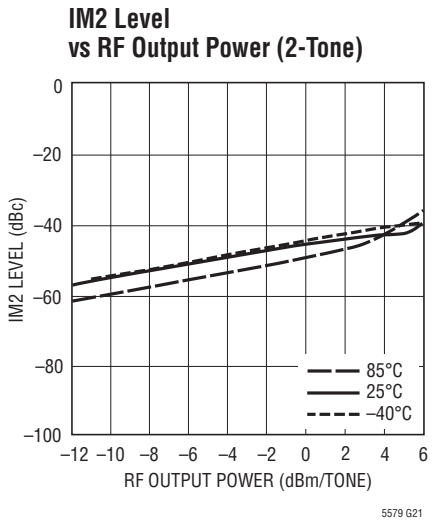
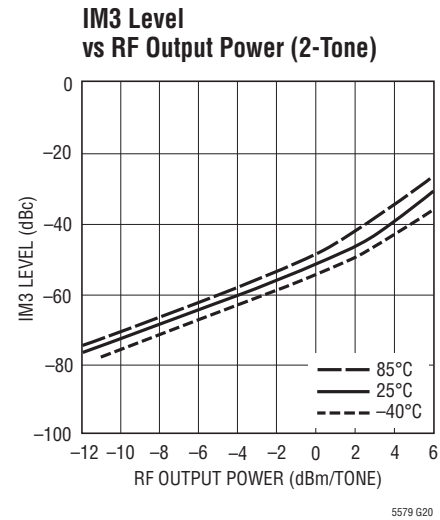
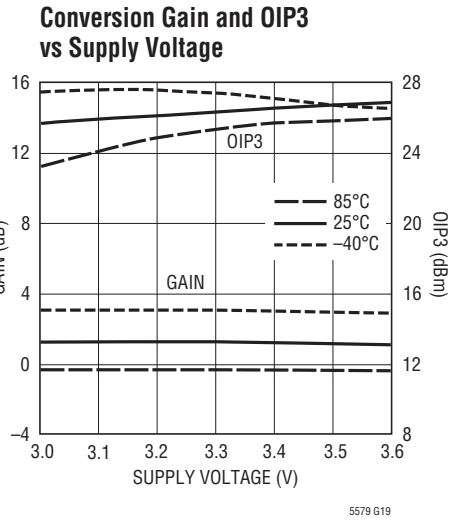
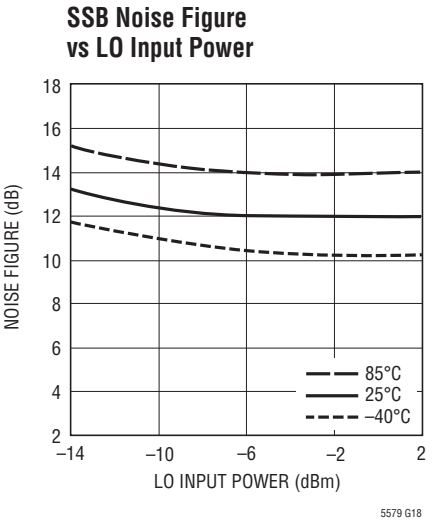
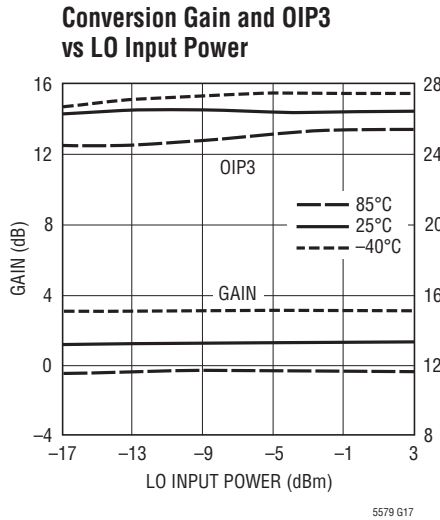
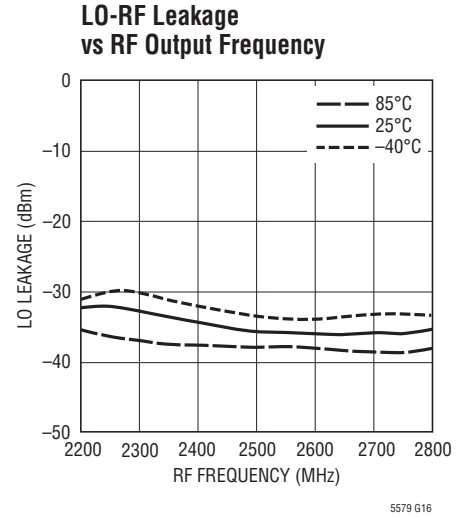
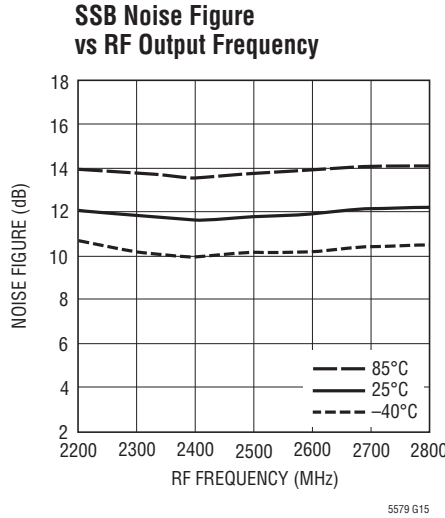
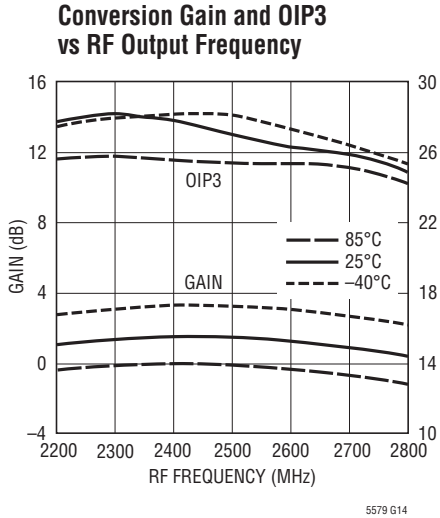

TYPICAL PERFORMANCE CHARACTERISTICS 2140MHz Application:

$V_{CC} = 3.3V$, $T_A = 25^\circ C$, $f_{IF} = 240MHz$, $P_{IF} = -5dBm$ (-5dBm/tone for 2-tone tests, $\Delta f = 1MHz$), high side LO, $P_{LO} = -1dBm$, output measured at 2140MHz, unless otherwise noted. (Test circuit shown in Figure 1)

Conversion Gain and OIP3 vs RF Output Frequency

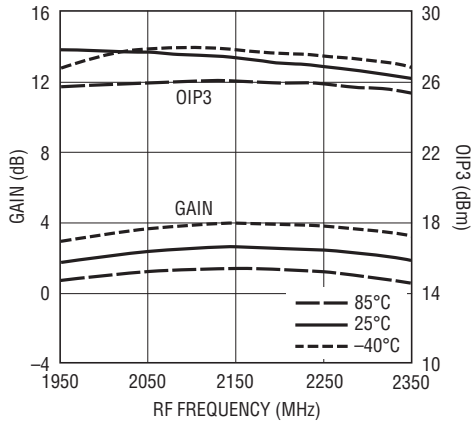

5579 G23

SSB Noise Figure vs RF Output Frequency

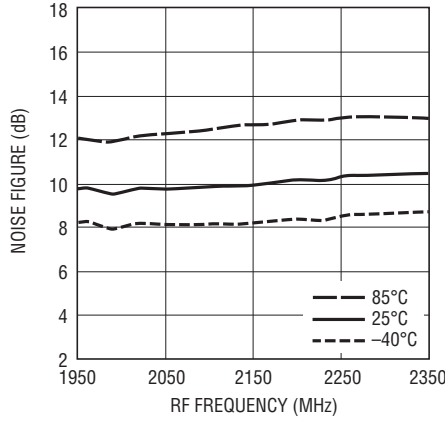

5579 G24

LO-RF Leakage vs RF Output Frequency

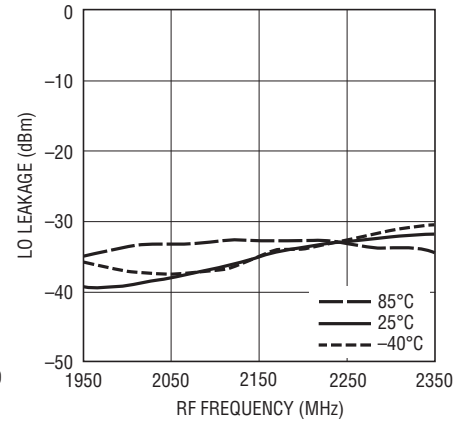

5579 G25

Conversion Gain and OIP3 vs LO Input Power

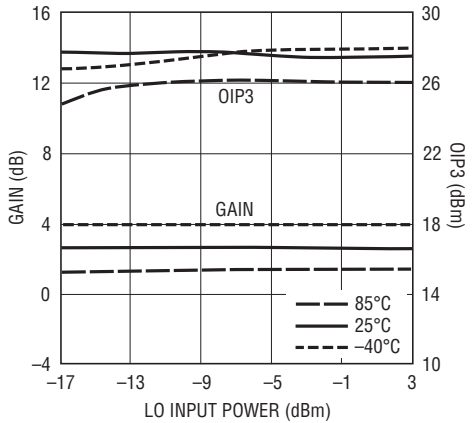

5579 G26

SSB Noise Figure vs LO Input Power

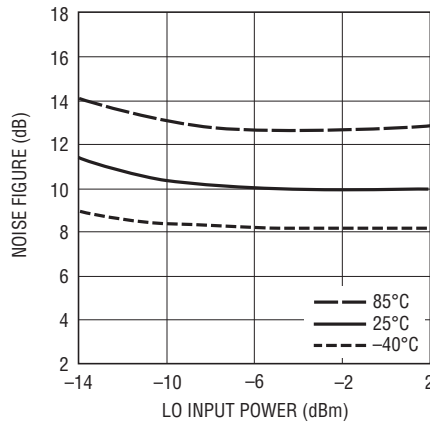

5579 G27

Conversion Gain and OIP3 vs Supply Voltage

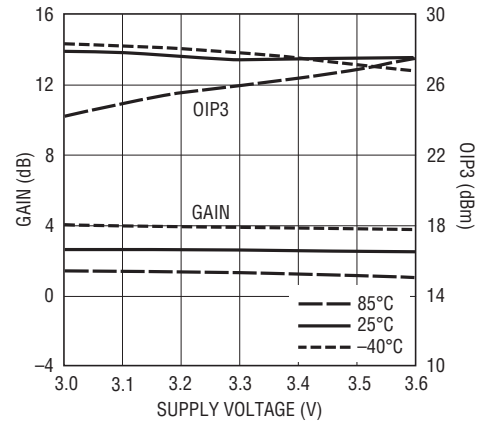

5579 G19

IM3 Level vs RF Output Power (2-Tone)

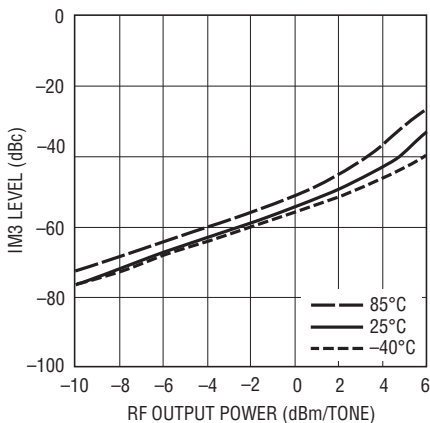

5579 G29

IM2 Level vs RF Output Power (2-Tone)

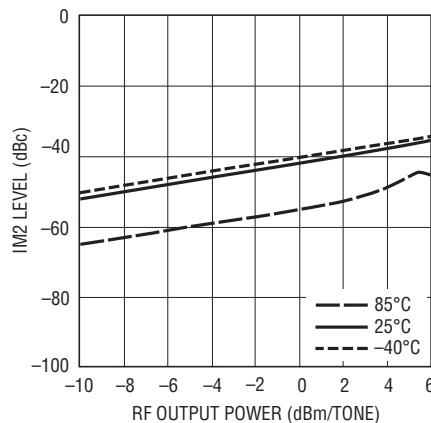

5579 G30

SSB Noise Figure vs Supply Voltage

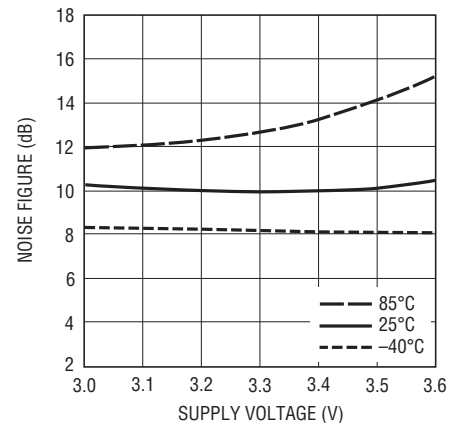

5579 G31

TYPICAL PERFORMANCE CHARACTERISTICS 1750MHz Application:

$V_{CC} = 3.3V$, $T_A = 25^\circ C$, $f_{IF} = 240MHz$, $P_{IF} = -5dBm$ (-5dBm/tone for 2-tone tests, $\Delta f = 1MHz$), low side LO, $P_{LO} = -1dBm$, output measured at 1750MHz, unless otherwise noted. (Test circuit shown in Figure 1)

Conversion Gain and OIP3 vs RF Output Frequency

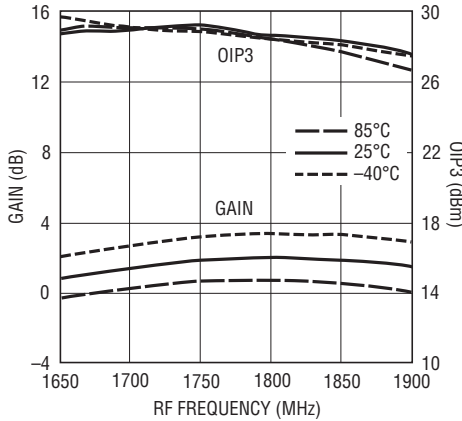

5579 G32

SSB Noise Figure vs RF Output Frequency

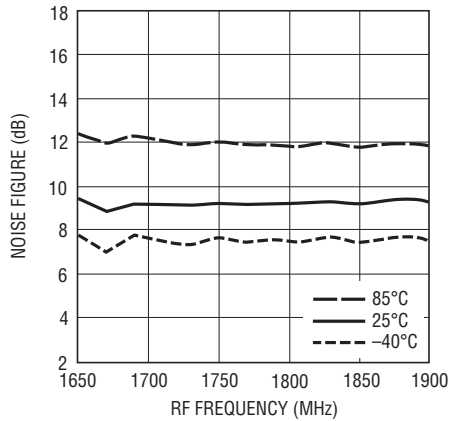

5579 G33

LO-RF Leakage vs RF Output Frequency

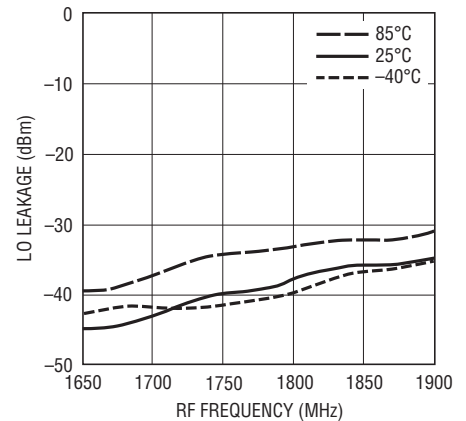

5579 G34

Conversion Gain and OIP3 vs LO Input Power

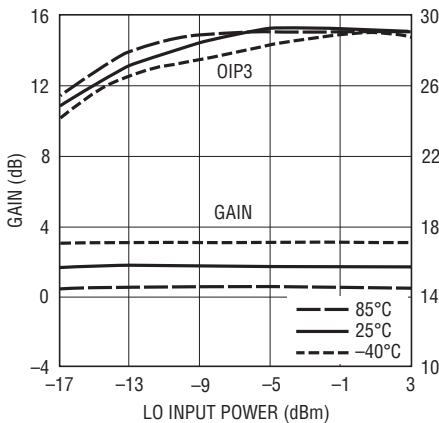

5579 G35

SSB Noise Figure vs LO Input Power

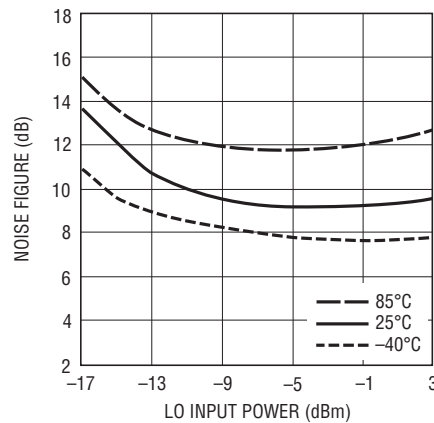

5579 G36

Conversion Gain and OIP3 vs Supply Voltage

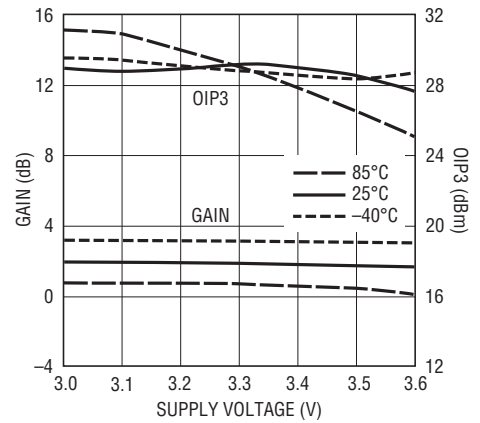

5579 G37

IM3 Level vs RF Output Power (2-Tone)

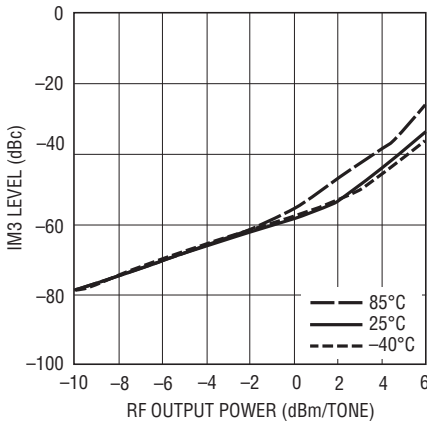

5579 G38

IM2 Level vs RF Output Power (2-Tone)

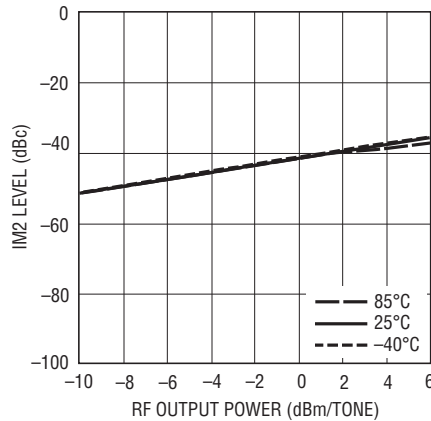

5579 G39

SSB Noise Figure vs Supply Voltage

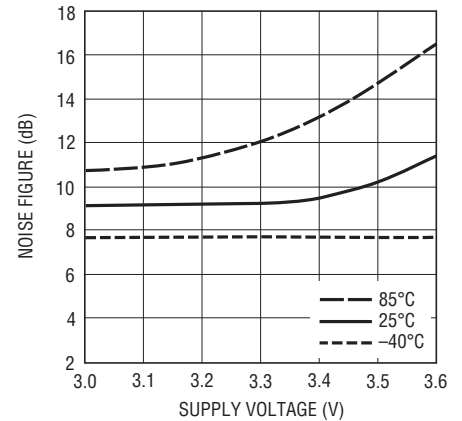

5579 G40

5579f

PIN FUNCTIONS

GND (Pins 1, 2, 5-7, 12-14, 16-18, 19-21, 23, 24): Ground Connections. These pins are internally connected to the exposed pad and should be soldered to a low impedance RF ground on the printed circuit board.

IF⁺, IF⁻ (Pins 3, 4): Differential IF Input. The common mode voltage on these pins is set internally to 570mV. The DC current from each pin is determined by the value of an external resistor to ground. The maximum DC current through each pin is 60mA.

V_{CC} (Pins 8-11): Power Supply Pins for the IC. These pins are connected together internally. Typical current consumption is 226mA. These pins should be connected together on the circuit board with external bypass capacitors of 1000pF, 100pF and 10pF located as close to the pins as possible.

RF (Pin 15): Single-Ended RF Output. This pin is connected to an internal transformer winding. The opposite end of the winding is grounded internally. An impedance transformation may be required to match the output and a DC decoupling capacitor is required if the following stage has a DC bias voltage present.

LO (Pin 22): Single-Ended Local Oscillator Input. An internal series capacitor acts as a DC block to this pin.

Exposed Pad (Pin 25): PGND. Electrical and thermal ground connection for the entire IC. This pad must be soldered to a low impedance RF ground on the printed circuit board. This ground must also provide a path for thermal dissipation.

BLOCK DIAGRAM

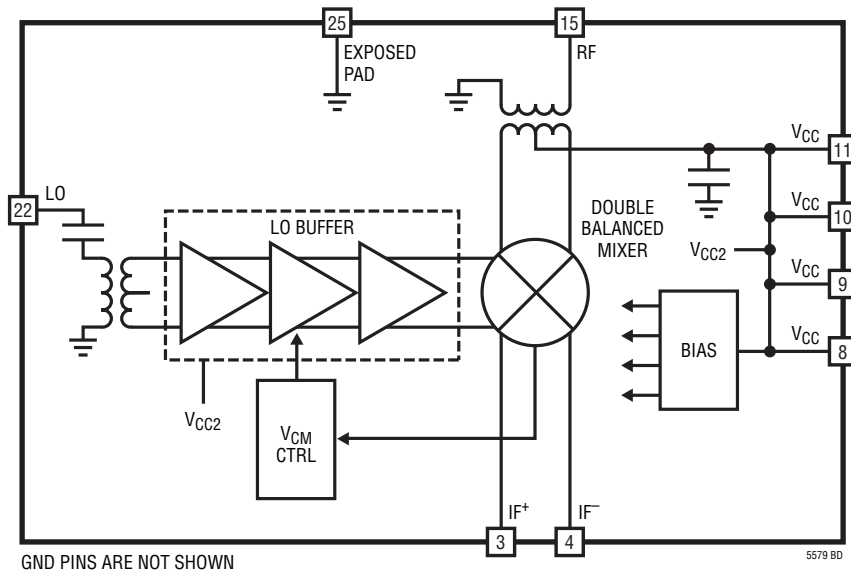

TEST CIRCUIT

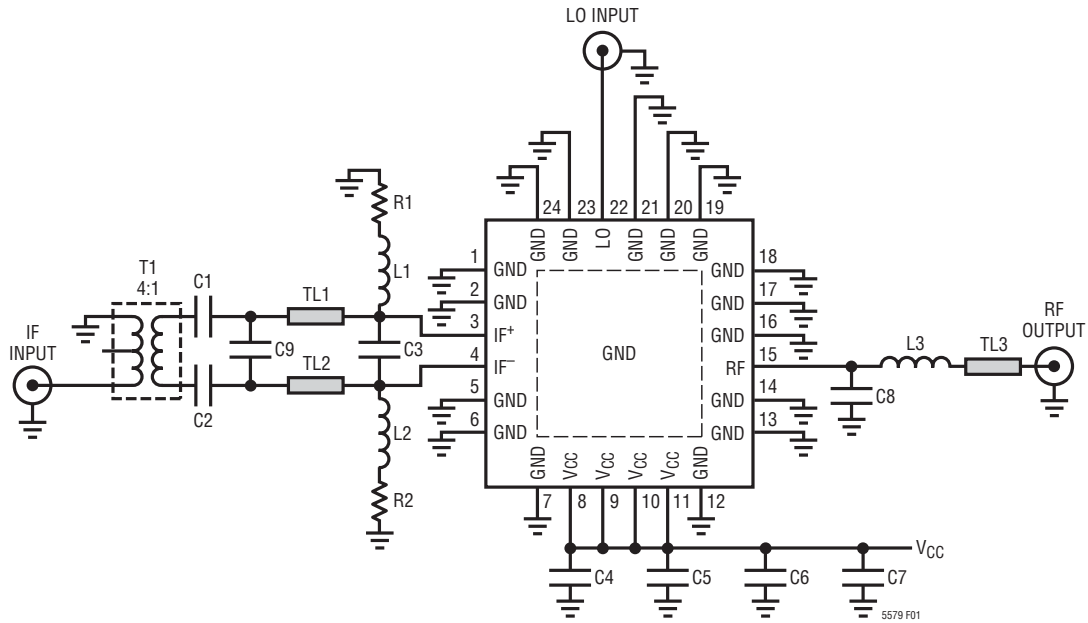

REF DES	$f_{RF} = 1750\text{MHz}$ $f_{IF} = 240\text{MHz}$	$f_{RF} = 2140\text{MHz}$ $f_{IF} = 240\text{MHz}$	$f_{RF} = 2600\text{MHz}$ $f_{IF} = 456\text{MHz}$	$f_{RF} = 3600\text{MHz}$ $f_{IF} = 456\text{MHz}$	SIZE	COMMENTS
C1, C2	82pF	82pF	33pF	33pF	0402	AVX
C3	—	—	2.7pF	1.8pF	0402	AVX
C4	100pF	100pF	100pF	100pF	0402	AVX
C5	10pF	10pF	10pF	10pF	0603	AVX
C6	1nF	1nF	1nF	1nF	0402	AVX
C7	1μF	1μF	1μF	1μF	0603	Taiyo Yuden LMK107BJ105MA
C8	1.2pF	0.45pF	—	0.7pF	0402	AVX ACCU-P
C9	33pF	33pF	33pF	33pF	0402	AVX
L1, L2	40nH	40nH	40nH	40nH	0402	Coilcraft 0402CS
L3	6.8nH	1.8nH	1nH	0Ω	0402	Toko LL1005-FHL/0Ω Jumper
R1, R2	11Ω, 0.1%	11Ω, 0.1%	11Ω, 0.1%	11Ω, 0.1%	0603	IRC PFC-W0603R-03-11R1-B
T1	4:1	4:1	4:1	4:1	SM-22	M/A-COM MABAES0061
TL1, TL2*	—	—	1.3mm	1.9mm	—	$Z_0 = 70\Omega$ Microstrip
TL3	2.3mm	2.3mm	2.3mm	2.3mm	—	$Z_0 = 70\Omega$ Microstrip

*Center-to-center spacing between C9 and C3. Center of C9 is 3.0mm from the edge of the IC package for all cases.

Figure 1. Test Circuit Schematic

APPLICATIONS INFORMATION

The LT5579 uses a high performance LO buffer amplifier driving a double-balanced mixer core to achieve frequency conversion with high linearity. Internal baluns are used to provide single-ended LO input and RF output ports. The IF input is differential. The LT5579 is intended for operation in the 1.5GHz to 3.8GHz frequency range, though operation outside this range is possible with reduced performance.

IF Input Interface

The IF inputs are tied to the emitters of the double-balanced mixer transistors, as shown in Figure 2. These pins are internally biased to a common mode voltage of 570mV. The optimum DC current in the mixer core is approximately 50mA per side, and is set by the external resistors, R1 and R2. The inductors and resistors must be able to handle the anticipated current and power dissipation. For best LO leakage performance the board layout must be symmetrical and the input resistors should be well matched (0.1% tolerance is recommended).

The purpose of the inductors (L1 and L2) is to reduce the loading effects of R1 and R2. The impedances of L1 and L2 should be at least several times greater than the IF input impedance at the desired IF frequency. The self-resonant frequency of the inductors should also be at least several times the IF frequency. Note that the DC resistances of L1 and L2 will affect the DC current and may need to be accounted for in the selection of R1 and R2.

L1 and L2 should connect to the signal lines as close to the package as possible. This location will be at the lowest impedance point, which will minimize the sensitivity of the performance to the loading of the shunt L-R branches.

Capacitors C1 and C2 are used to cancel out the parasitic series inductance of the IF transformer. They also provide DC isolation between the IF ports to prevent unwanted interactions that can affect the LO to RF leakage performance.

The differential input resistance to the mixer is approximately 10Ω , as indicated in Table 1. The package and external inductances (TL1 and TL2) are used along with

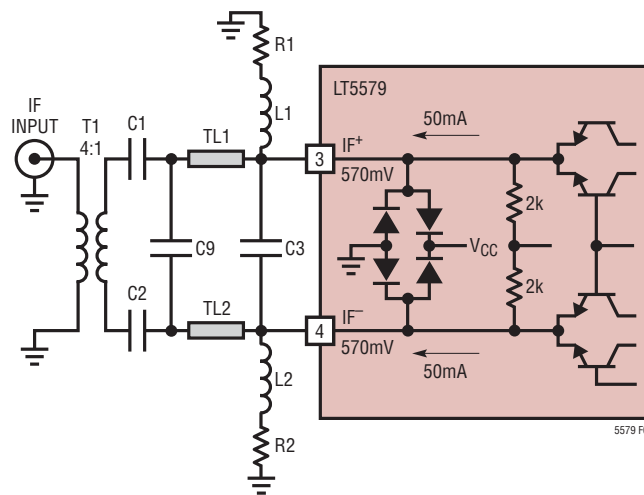

Figure 2. IF Input with External Matching

APPLICATIONS INFORMATION

C9 to step the impedance up to about 12.5Ω. At lower frequencies additional series inductance may be required between the IF ports and C9. The position of C9 may vary with the IF frequency due to the different series inductance requirements. The 4:1 impedance ratio of transformer T1 completes the transformation to 50 ohms. Table 1 lists the differential IF input impedances and reflection coefficients for several frequencies.

Table 1. IF Input Differential Impedance

FREQUENCY (MHz)	IF INPUT IMPEDANCE	REFLECTION COEFFICIENT	
		MAG	ANGLE
70	8.8+j1.3	0.70	177
140	8.7+j2.3	0.70	175
170	9.0+j2.8	0.70	174
190	8.9+j3.0	0.70	173
240	9.0+j4.0	0.70	170
380	9.7+j4.9	0.68	168
450	10.0+j5.2	0.67	167
750	10.8+j9.4	0.65	158
1000	11.8+j13.8	0.64	148

The purpose of capacitor C3 is to improve the LO-RF leakage in some applications. This relatively small-valued capacitor has little effect on the impedance match in most cases. This capacitor should typically be located close to the IC, however, there may be cases where re-positioning the capacitor may improve performance.

The measured return loss of the IF input is shown in Figure 3 for application frequencies of 70MHz, 240MHz and 456MHz. Component values are listed in Table 2. (For 70MHz matching details, refer to Figure 8.)

Table 2. IF Input Component Values

FREQUENCY (MHz)	C1, C2 (pF)	C9 (pF)	C3 (pF)	L1, L2 (nH)	R1, R2 (Ω)	MATCH BW (at 12dB RL)
140	1000	120	(1)	100	9.1	<50 to 158
240	82	33	(1)	40	11	174 to 263
450	33	33	(1)	40	11	330 to 505

Note: (1) Depends on RF, (2) T1 = M/A-Com MABAES0061

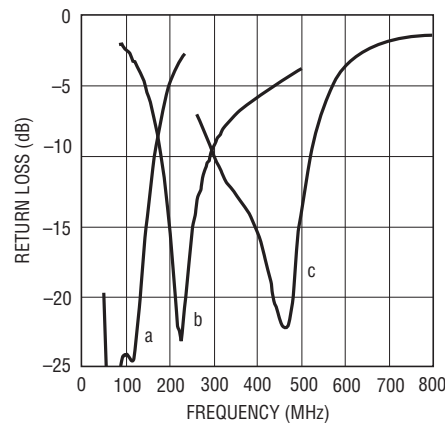

5579 F03

Figure 3. IF Input Return Loss with 70MHz (a), 240MHz (b) and 456MHz (c) Matching

APPLICATIONS INFORMATION

LO Input Interface

The simplified schematic for the single-ended LO input port is shown in Figure 4. An internal transformer provides a broadband impedance match and performs single-ended to differential conversion. An internal capacitor also aids in impedance matching and provides DC isolation to the primary transformer winding. The transformer secondary feeds the differential limiting amplifier stages that drive the mixer core.

The measured return loss of the LO input port is shown in Figure 5 for an LO input power of -1 dBm . The impedance match is acceptable from about 1.1GHz to beyond 4GHz, with a minimum return loss across this range of about 9dB at 2300MHz. If desired, the return loss can be improved below 1.1GHz by external components as shown in Figure 4. The return loss can also be improved by reducing the LO drive level, though performance will degrade if the level is too low.

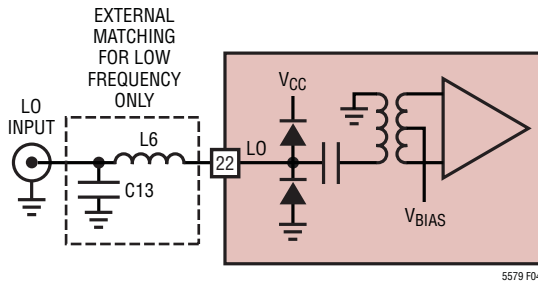

Figure 4. LO Input Circuit

While external matching of the LO input is not required for frequencies above 1.1GHz, external matching should be used for lower LO frequencies for best performance. Table 3 lists the input impedance and reflection coefficient vs frequency for the LO input for use in such cases.

Table 3. Single-Ended LO Input Impedance (at Pin 22, No External Match)

FREQUENCY (MHz)	INPUT IMPEDANCE	REFLECTION COEFFICIENT	
		MAG	ANGLE
750	63.3 -j30.5	0.68	-125
1000	20.3 -j1120	0.42	-179
1500	78.4 -j1250	0.22	-7.7
1900	79.1 -j113	0.34	-65.2
2000	74.7 -j96.3	0.35	-74.7
2150	66.8 -j81.5	0.36	-87.0
2400	53.8 -j69.8	0.35	-105
3050	33.7 -j115	0.26	-148
3150	33.0 -j146	0.24	-154
4000	43.9 +j173	0.15	-123

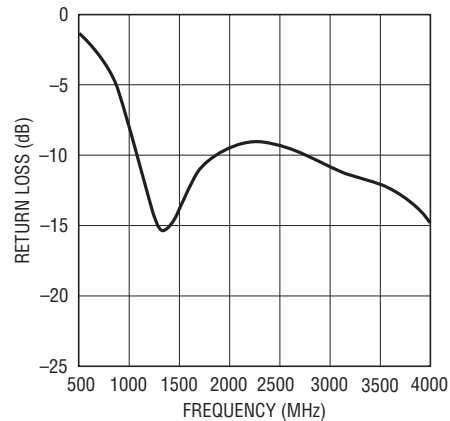

Figure 5. LO Input Return Loss

APPLICATIONS INFORMATION

RF Output Interface

The RF output interface is shown in Figure 6. An internal RF transformer reduces the mixer core output impedance to simplify matching of the RF output pin. A center tap in the transformer provides the DC connection to the mixer core and the transformer provides DC isolation to the RF output. The RF pin is internally grounded through the secondary winding of the transformer, thus a DC voltage should not be applied to this pin.

While the LT5579 performs best at frequencies above 1500MHz, the part can be used down to 900MHz. The internal RF transformer is not optimized for these lower frequencies, thus the gain and impedance matching bandwidth will decrease due to the low transformer inductance. The impedance data for the RF output, listed in Table 4, can be used to develop matching networks for different frequencies or load impedances. Figure 7 illustrates the output return loss performance for several applications. The component values and approximate matching bandwidths are listed in Table 5.

DC and RF Grounding

The LT5579 relies on the back side ground for both RF and thermal performance. The Exposed Pad must be soldered to the low impedance topside ground plane of the board. Several vias should connect the topside ground to other ground layers to aid in thermal dissipation.

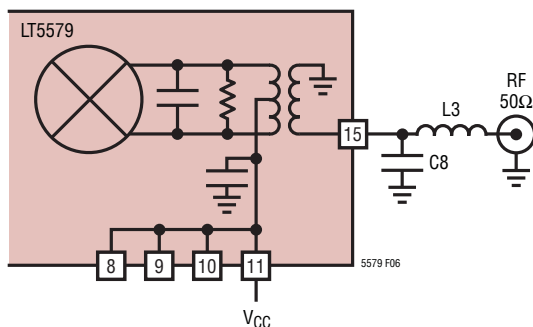

Figure 6. RF Output Circuit

Table 4. Single-Ended RF Output Impedance (at Pin 15, No External Matching)

FREQUENCY (MHz)	RF OUTPUT IMPEDANCE	REFLECTION COEFFICIENT	
		MAG	ANGLE
1250	11.0+j42.7	0.78	97.4
1750	55.6+j83.4	0.62	47.8
1950	119+j62.4	0.52	21.9
2150	116-j21.0	0.42	-10.4
2300	73.7-j37.7	0.34	-40.9
2600	35.2-j21.5	0.30	-110
3600	21.9+j17.8	0.45	134

Table 5. RF Output Component Values

FREQUENCY (MHz)	C8 (pF)	L3 (nH)	MATCH BW (at 12dB RL)
1650	1.5	6.8	1630 to 1770
1750	1.2	6.8	1725 to 1870
1950	1	4.7	1840 to 2020
2140	0.45	3.9	2035 to 2285
2600	0.45	1.8	2260 to 2780*
3600	0.7	0Ω	3170 to 4100*

*10dB Return Loss bandwidth

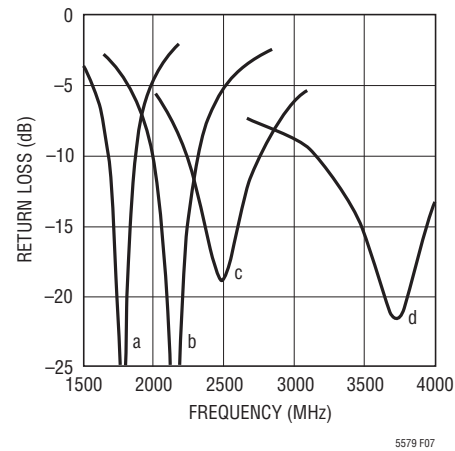

Figure 7. RF Output Return Loss with 1750MHz (a), 2140MHz (b), 2600MHz (c) and 3600MHz (d) Matching

TYPICAL APPLICATIONS

The following examples illustrate the implementation and performance of the LT5579 in different frequency configurations. These circuits were evaluated using the circuit board shown in Figure 12.

1650MHz Application

In this case, the LT5579 was evaluated while tuned for an IF of 70MHz and an RF output of 1650MHz. The matching configuration is shown in Figure 8.

Input capacitors are used only as DC blocks in this application. The 4.7nH inductors and the 120pF capacitor transform the input impedance of the IC up to approximately

12.5Ω. The relatively low input frequency demanded the use of 4.7nH chip inductors instead of short transmission lines.

Closer to the IC input, 47pF capacitors were used instead of a single differential capacitor (C3 in Figure 1), because it was found that the addition of common mode capacitance improved the high side LO performance in this application. The value of these 47pF capacitors was selected to resonate with the 100nH inductors at 70MHz. Note that adding common mode capacitance does not improve performance with all frequency configurations.

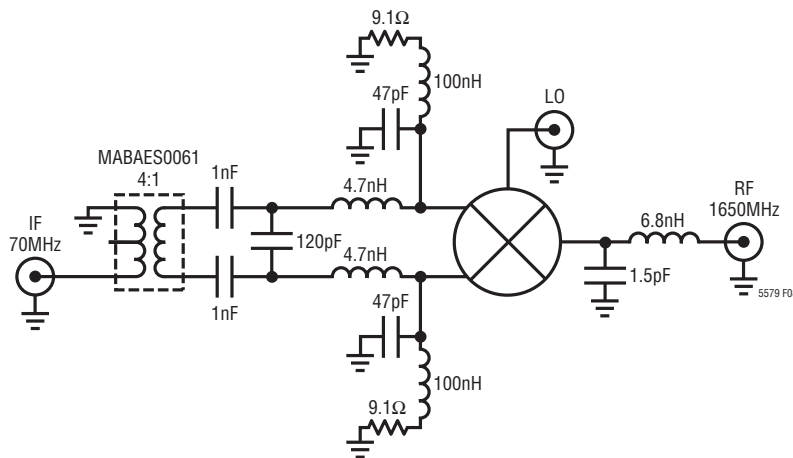

Figure 8. IF Input Tuned for 70MHz

TYPICAL APPLICATIONS

The RF port impedance match was realized with $C8 = 1.5\text{pF}$ and $L3 = 6.8\text{nH}$. The optimum impedance match was purposefully shifted high in order to achieve better OIP3 performance at the desired frequency.

Figure 9 shows the measured conversion gain and OIP3 as a function of RF output frequency. As mentioned above, the output impedance match is shifted towards the high side of the band, and this is evidenced by the positive slope of the gain. The single sideband noise figure across the frequency range is also shown.

Curves for both high side and low side LO cases are shown. In this particular application, the low side OIP3 outperforms the high side case.

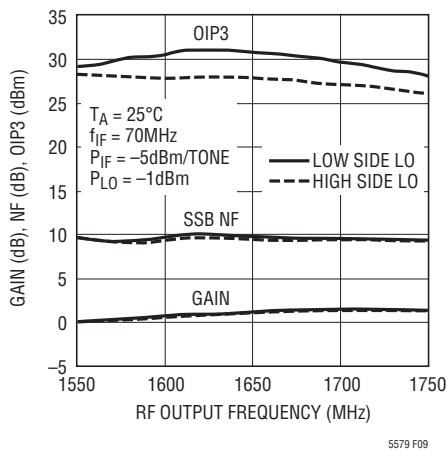

Figure 9. Gain, Noise Figure and OIP3 vs RF Frequency with 70MHz IF and 1650MHz RF

1950MHz Application

In this example, a high side LO was used to convert the IF input signal at 240MHz to 1950MHz at the RF output. The RF port impedance match was realized with $C8 = 1\text{pF}$ and $L3 = 4.7\text{nH}$. As in the 1650MHz case, it was found that tuning the output match slightly high in frequency gave better OIP3 results at the desired frequency. The input match for 240MHz operation is the same as described in the test circuit of Figure 1.

The measured 1950MHz performance is plotted in Figure 10 for both low side and high side LO drive. With this matching configuration, the low side LO case outperforms the high side LO. The gain, noise figure (SSB) and OIP3 are plotted as a function of RF output frequency.

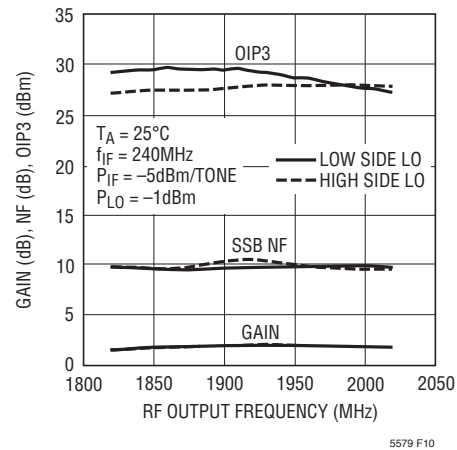
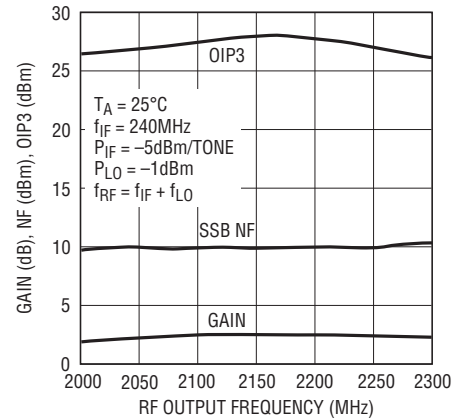

Figure 10. Gain, Noise Figure and OIP3 vs RF Frequency for the 1950MHz Application

TYPICAL APPLICATIONS

2140MHz with Low Side LO

The LT5579 was fully characterized with an RF output of 2140MHz and a high side LO. The part also works well when driven with low side LO, however, the performance benefited from the addition of common mode capacitance to the IF input match. A 10pF capacitor to ground was added to each IF pin. These capacitors were attached near inductors L1 and L2. The measured performance is shown in Figure 11.



5579 F11

Figure 11. Measured Performance when Tuned for 240MHz IF, 2140MHz RF and Low Side LO

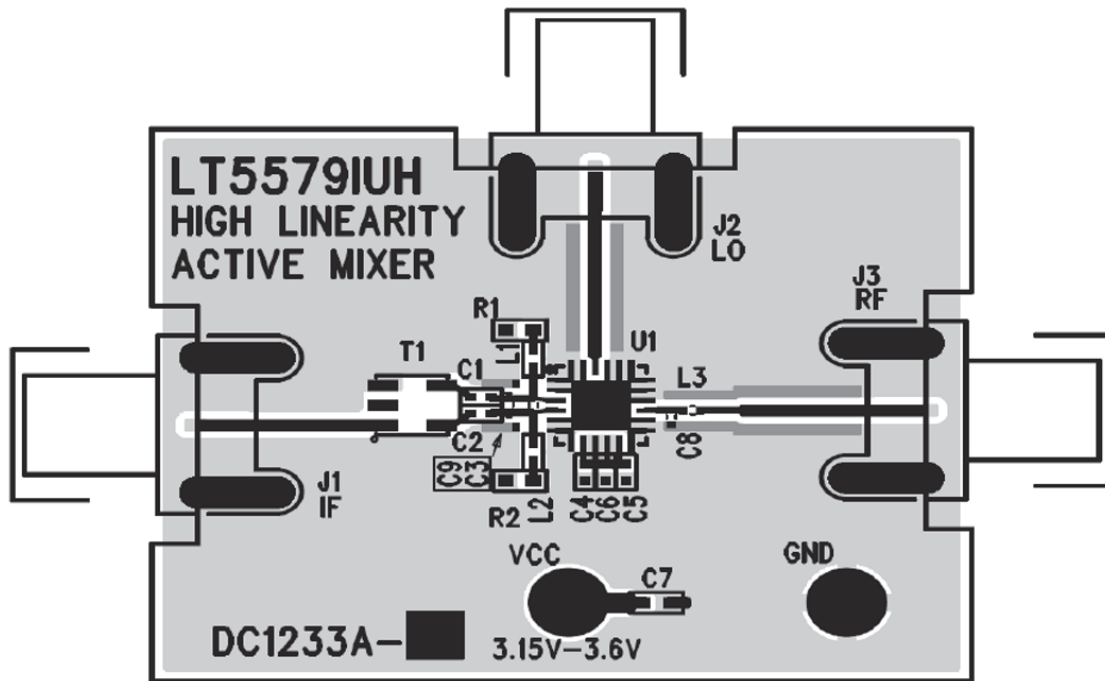
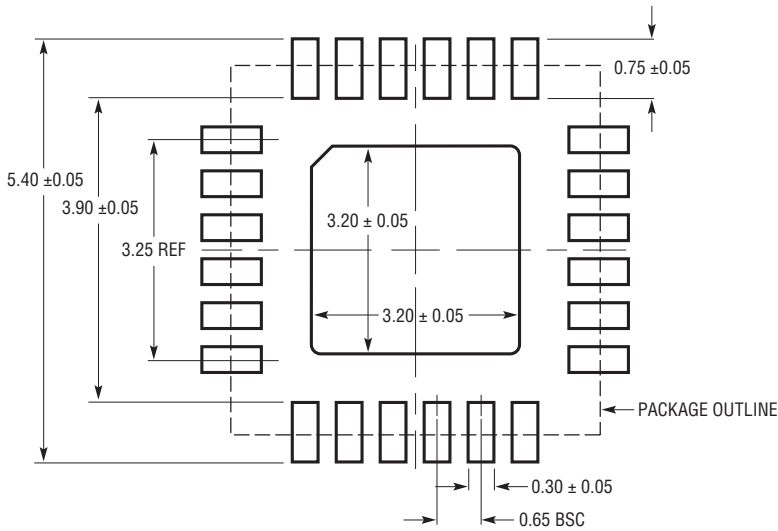

Figure 12. LT5579 Evaluation Board (DC1233A)

PACKAGE DESCRIPTION

UH Package
24-Lead Plastic QFN (5mm × 5mm)
 (Reference LTC DWG # 05-08-1747 Rev 0)



RECOMMENDED SOLDER PAD LAYOUT
 APPLY SOLDER MASK TO AREAS THAT ARE NOT SOLDERED

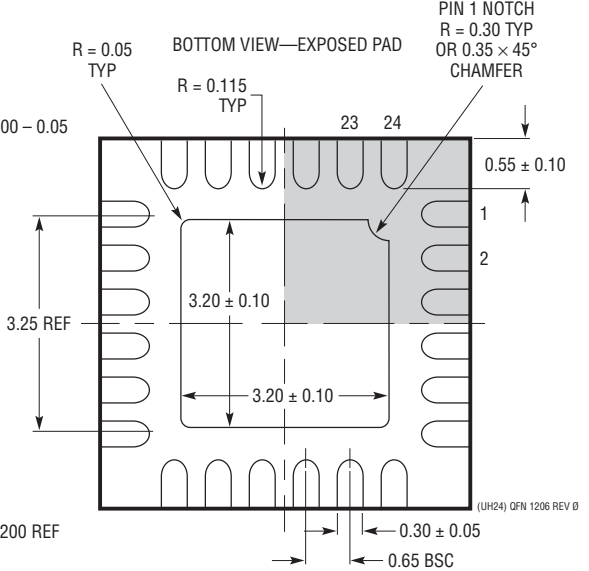
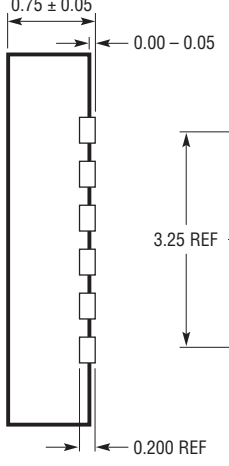
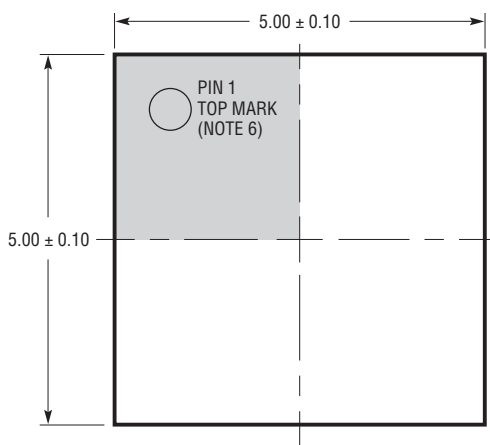

- NOTE:
1. DRAWING IS NOT A JEDEC PACKAGE OUTLINE
 2. DRAWING NOT TO SCALE
 3. ALL DIMENSIONS ARE IN MILLIMETERS
 4. DIMENSIONS OF EXPOSED PAD ON BOTTOM OF PACKAGE DO NOT INCLUDE MOLD FLASH. MOLD FLASH, IF PRESENT, SHALL NOT EXCEED 0.20mm ON ANY SIDE
 5. EXPOSED PAD SHALL BE SOLDER PLATED
 6. SHADED AREA IS ONLY A REFERENCE FOR PIN 1 LOCATION ON THE TOP AND BOTTOM OF PACKAGE

(UH24) QFN 1206 REV 0

RELATED PARTS

PART NUMBER	DESCRIPTION	COMMENTS
Infrastructure		
LT5514	Ultralow Distortion, IF Amplifier/ADC Driver with Digitally Controlled Gain	850MHz Bandwidth, 47dBm OIP3 at 100MHz, 10.5dB to 33dB Gain Control Range
LT5517	40MHz to 900MHz Quadrature Demodulator	21dBm IIP3, Integrated LO Quadrature Generator
LT5518	1.5GHz to 2.4GHz High Linearity Direct Quadrature Modulator	22.8dBm OIP3 at 2GHz, -158.2dBm/Hz Noise Floor, 50Ω Single-Ended RF and LO Ports, 4-Channel W-CDMA ACPR = -64dBc at 2.14GHz
LT5519	0.7GHz to 1.4GHz High Linearity Upconverting Mixer	17.1dBm IIP3 at 1GHz, Integrated RF Output Transformer with 50Ω Matching, Single-Ended LO and RF Ports Operation
LT5520	1.3GHz to 2.3GHz High Linearity Upconverting Mixer	15.9dBm IIP3 at 1.9GHz, Integrated RF Output Transformer with 50Ω Matching, Single-Ended LO and RF Ports Operation
LT5521	10MHz to 3700MHz High Linearity Upconverting Mixer	24.2dBm IIP3 at 1.95GHz, NF = 12.5dB, 3.15V to 5.25V Supply, Single-Ended LO Port Operation
LT5522	400MHz to 2.7GHz High Signal Level Downconverting Mixer	4.5V to 5.25V Supply, 25dBm IIP3 at 900MHz, NF = 12.5dB, 50Ω Single-Ended RF and LO Ports
LT5524	Low Power, Low Distortion ADC Driver with Digitally Programmable Gain	450MHz Bandwidth, 40dBm OIP3, 4.5dB to 27dB Gain Control
LT5525	High Linearity, Low Power Downconverting Mixer	Single-Ended 50Ω RF and LO Ports, 17.6dBm IIP3 at 1900MHz, I _{CC} = 28mA
LT5526	High Linearity, Low Power Downconverting Mixer	3V to 5.3V Supply, 16.5dBm IIP3, 100kHz to 2GHz RF, NF = 11dB, I _{CC} = 28mA, -65dBm LO-RF Leakage
LT5527	400MHz to 3.7GHz High Signal Level Downconverting Mixer	IIP3 = 23.5dBm and NF = 12.5dBm at 1900MHz, 4.5V to 5.25V Supply, I _{CC} = 78mA, Conversion Gain = 2dB
LT5528	1.5GHz to 2.4GHz High Linearity Direct Quadrature Modulator	21.8dBm OIP3 at 2GHz, -159.3dBm/Hz Noise Floor, 50Ω, 0.5V _{DC} Baseband Interface, 4-Channel W-CDMA ACPR = -66dBc at 2.14GHz
LT5557	400MHz to 3.8GHz 3.3V Downconverting Mixer	IIP3 = 23.5dBm at 3.6GHz, NF = 15.4dB, Conversion Gain = 1.7dB, 3.3V Supply at 82mA, Single-Ended RF and LO Inputs
LT5558	600MHz to 1100MHz High Linearity Direct Quadrature Modulator	22.4dBm OIP3 at 900MHz, -158dBm/Hz Noise Floor, 3kΩ, 2.1V _{DC} Baseband Interface, 3-Ch CDMA2000 ACPR = -70.4dBc at 900MHz
LT5560	Ultra-Low Power Active Mixer	10mA Supply Current, 10dBm IIP3, 10dB NF, Usable as Up- or Down-Converter.
LT5568	700MHz to 1050MHz High Linearity Direct Quadrature Modulator	22.9dBm OIP3 at 850MHz, -160.3dBm/Hz Noise Floor, 50Ω, 0.5V _{DC} Baseband Interface, 3-Ch CDMA2000 ACPR = -71.4dBc at 850MHz
LT5572	1.5GHz to 2.5GHz High Linearity Direct Quadrature Modulator	21.6dBm OIP3 at 2GHz, -158.6dBm/Hz Noise Floor, High-Ohmic 0.5V _{DC} Baseband Interface, 4-Ch W-CDMA ACPR = -67.7dBc at 2.14GHz
LT5575	700MHz to 2.7GHz Direct Conversion I/Q Demodulator	Integrated Baluns, 28dBm IIP3, 13dBm P1dB, 0.03dB I/Q Amplitude Match, 0.4° Phase Match
RF Power Detectors		
LTC [®] 5505	RF Power Detectors with >40dB Dynamic Range	300MHz to 3GHz, Temperature Compensated, 2.7V to 6V Supply
LTC5507	100kHz to 1000MHz RF Power Detector	100kHz to 1GHz, Temperature Compensated, 2.7V to 6V Supply
LTC5508	300MHz to 7GHz RF Power Detector	44dB Dynamic Range, Temperature Compensated, SC70 Package
LTC5509	300MHz to 3GHz RF Power Detector	36dB Dynamic Range, Low Power Consumption, SC70 Package
LTC5530	300MHz to 7GHz Precision RF Power Detector	Precision V _{OUT} Offset Control, Shutdown, Adjustable Gain
LTC5531	300MHz to 7GHz Precision RF Power Detector	Precision V _{OUT} Offset Control, Shutdown, Adjustable Offset
LTC5532	300MHz to 7GHz Precision RF Power Detector	Precision V _{OUT} Offset Control, Adjustable Gain and Offset
LT5534	50MHz to 3GHz Log RF Power Detector with 60dB Dynamic Range	±1dB Output Variation over Temperature, 38ns Response Time, Log Linear Response
LTC5536	Precision 600MHz to 7GHz RF Power Detector with Fast Comparator Output	25ns Response Time, Comparator Reference Input, Latch Enable Input, -26dBm to +12dBm Input Range
LT5537	Wide Dynamic Range Log RF/IF Detector	Low Frequency to 1GHz, 83dB Log Linear Dynamic Range
LT5570	2.7GHz Mean-Squared Detector	±0.5dB Accuracy Over Temperature and >50dB Dynamic Range, Fast 500ns Rise Time