

## FEATURES

### Low offset voltage

**B grade: 0.4 mV maximum**

**A grade: 1 mV maximum**

### Low offset voltage drift

**B grade: 4  $\mu\text{V}/^\circ\text{C}$  maximum**

**A grade: 8  $\mu\text{V}/^\circ\text{C}$  maximum**

### Low input bias current: 5 pA typical at $V_{\text{SY}} = \pm 15\text{ V}$

### Dual-supply operation: $\pm 4.5\text{ V}$ to $\pm 15\text{ V}$

### Low noise

**7.3 nV/ $\sqrt{\text{Hz}}$  typical at  $f = 1\text{ kHz}$**

**0.45  $\mu\text{V p-p}$  at 0.1 Hz to 10 Hz**

### Low distortion: 0.00006%

### No phase reversal

### Rail-to-rail output

### Unity gain stable

## APPLICATIONS

### Instrumentation

### Medical instruments

### Multipole filters

### Precision current measurement

### Photodiode amplifiers

### Sensors

### Audio

## GENERAL DESCRIPTION

The [ADA4610-2](#) is a dual channel, precision JFET amplifier that features low input voltage and current noise, offset voltage, input bias current, and rail-to-rail output.

The combination of low offset, noise, and very low input bias current makes these amplifiers especially suitable for high impedance sensor amplification and precise current measurements using shunts. With excellent dc precision, low noise, and fast settling time, the [ADA4610-2](#) provides superior accuracy in medical instruments, electronic measurement, and automated test equipment. Unlike many competitive amplifiers, the [ADA4610-2](#) maintains fast settling performance with substantial capacitive loads. Unlike many older JFET amplifiers, the [ADA4610-2](#) does not suffer from output phase reversal when input voltages exceed the maximum common-mode voltage range.

### Rev. A

Information furnished by Analog Devices is believed to be accurate and reliable. However, no responsibility is assumed by Analog Devices for its use, nor for any infringements of patents or other rights of third parties that may result from its use. Specifications subject to change without notice. No license is granted by implication or otherwise under any patent or patent rights of Analog Devices. Trademarks and registered trademarks are the property of their respective owners.

## PIN CONFIGURATIONS



### NOTES

1. THE EXPOSED PAD MUST BE CONNECTED TO  $V_{-}$ .

Figure 1. 8-Lead LFCSP (CP Suffix)

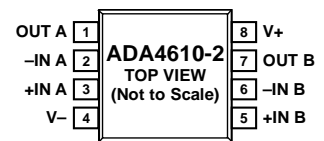

Figure 2. 8-Lead SOIC\_N (R Suffix) and 8-Lead MSOP (RM Suffix)

The fast slew rate and great stability with capacitive loads make the [ADA4610-2a](#) perfect fit for high performance filters. Low input bias currents, low offset, and low noise result in a wide dynamic range for photodiode amplifier circuits. Low noise and distortion, high output current, and excellent speed make the [ADA4610-2](#) a great choice for audio applications.

The [ADA4610-2](#) is specified over the  $-40^\circ\text{C}$  to  $+125^\circ\text{C}$  extended industrial temperature range.

The [ADA4610-2](#) is available in the 8-lead narrow SOIC, 8-lead MSOP, and 8-lead LFCSP packages.

**TABLE OF CONTENTS**

Features .....	1	ESD Caution.....	6
Applications.....	1	Typical Performance Characteristics .....	7
Pin Configurations .....	1	Comparative Voltage and Variable Voltage Graphs.....	13
General Description .....	1	Applications Information .....	15
Revision History .....	2	Comparator Operation.....	15
Specifications.....	3	Outline Dimensions .....	16
Electrical Characteristics .....	4	Ordering Guide .....	17
Absolute Maximum Ratings.....	6		

**REVISION HISTORY**

**5/12—Rev. 0 to Rev. A**

Changes to Data Sheet Title and General Description Section..	1
Changed Input Impedance, Differential to Input Capacitance, Differential in Table 1.....	3
Added Input Resistance in Table 1 .....	3
Changed Input Impedance, Differential to Input Capacitance, Differential in Table 2.....	4
Added Input Resistance in Table 2 .....	4
Added Figure 9, Figure 10, and Figure 14 .....	8
Added Figure 15.....	9
Updated Outline Dimensions .....	16
Changes to Ordering Guide .....	17

**12/11—Revision 0: Initial Version**

## SPECIFICATIONS

$V_{SY} = \pm 5\text{ V}$ ,  $V_{CM} = 0\text{ V}$ ,  $T_A = 25^\circ\text{C}$ , unless otherwise noted.

Table 1.

Parameter	Symbol	Test Conditions/Comments	Min	Typ	Max	Unit
<b>INPUT CHARACTERISTICS</b>						
Offset Voltage (B Grade) <sup>1</sup>	$V_{OS}$	$-40^\circ\text{C} < T_A < +125^\circ\text{C}$		0.2	0.4	mV
Offset Voltage (A Grade) <sup>1</sup>	$V_{OS}$	$-40^\circ\text{C} < T_A < +125^\circ\text{C}$		0.4	1	mV
Offset Voltage Drift (B Grade) <sup>2</sup>	$\Delta V_{OS}/\Delta T$			0.5	4	$\mu\text{V}/^\circ\text{C}$
Offset Voltage Drift (A Grade) <sup>2</sup>	$\Delta V_{OS}/\Delta T$			1	8	$\mu\text{V}/^\circ\text{C}$
Input Bias Current	$I_B$	$-40^\circ\text{C} < T_A < +125^\circ\text{C}$		5	25	pA
Input Offset Current	$I_{OS}$	$-40^\circ\text{C} < T_A < +125^\circ\text{C}$		2	20	pA
Input Voltage Range			-2.5		+2.5	V
Common-Mode Rejection Ratio	CMRR	$V_{CM} = -2.5\text{ V to }+2.5\text{ V}$ $-40^\circ\text{C} < T_A < +125^\circ\text{C}$	94	110		dB
Large Signal Voltage Gain	$A_{VO}$	$R_L = 2\text{ k}\Omega$ , $V_{OUT} = -3.5\text{ V to }+3.5\text{ V}$ $-40^\circ\text{C} < T_A < +125^\circ\text{C}$	98	100		dB
Input Capacitance, Differential		$V_{CM} = 0\text{ V}$		3.1		pF
Input Capacitance, Common-Mode		$V_{CM} = 0\text{ V}$		4.8		pF
Input Resistance		$V_{CM} = 0\text{ V}$		$>1 \times 10^{13}$		$\Omega$
<b>OUTPUT CHARACTERISTICS</b>						
Output Voltage High	$V_{OH}$	$R_L = 2\text{ k}\Omega$ $-40^\circ\text{C} < T_A < +125^\circ\text{C}$	4.85	4.90		V
		$R_L = 600\ \Omega$ $-40^\circ\text{C} < T_A < +125^\circ\text{C}$	4.6	4.89		V
Output Voltage Low	$V_{OL}$	$R_L = 2\text{ k}\Omega$ $-40^\circ\text{C} < T_A < +125^\circ\text{C}$	4.05	-4.95	-4.9	V
		$R_L = 600\ \Omega$ $-40^\circ\text{C} < T_A < +125^\circ\text{C}$		-4.9	-4.75	V
		$-40^\circ\text{C} < T_A < +125^\circ\text{C}$			-4.4	V
Short-Circuit Current	$I_{SC}$			$\pm 63$		mA
<b>POWER SUPPLY</b>						
Power Supply Rejection Ratio	PSRR	$V_{SY} = \pm 4.5\text{ V to } \pm 18\text{ V}$ $-40^\circ\text{C} < T_A < +125^\circ\text{C}$	106	125		dB
Supply Current/Amplifier	$I_S$	$I_{OUT} = 0\text{ mA}$ $-40^\circ\text{C} < T_A < +125^\circ\text{C}$		1.5	1.7	mA
					1.85	mA
<b>DYNAMIC PERFORMANCE</b>						
Gain Bandwidth Product	GBP	$V_{IN} = 5\text{ mV p-p}$ , $R_L = 2\text{ k}\Omega$ , $A_V = 100$		15.4		MHz
Unity-Gain Crossover	UGC	$V_{IN} = 5\text{ mV p-p}$ , $R_L = 2\text{ k}\Omega$ , $A_V = -10$		9.3		MHz
Phase Margin	$\phi_M$			61		Degrees
-3 dB Closed-Loop Bandwidth	-3 dB	$A_V = 1$ , $V_{IN} = 5\text{ mV p-p}$		10.6		MHz
<b>NOISE PERFORMANCE</b>						
Voltage Noise	$e_n$ p-p	0.1 Hz to 10 Hz		0.45		$\mu\text{V p-p}$
Voltage Noise Density	$e_n$	$f = 10\text{ Hz}$		14		$\text{nV}/\sqrt{\text{Hz}}$
		$f = 100\text{ Hz}$		8.2		$\text{nV}/\sqrt{\text{Hz}}$
		$f = 1\text{ kHz}$		7.3		$\text{nV}/\sqrt{\text{Hz}}$
		$f = 10\text{ kHz}$		7.3		$\text{nV}/\sqrt{\text{Hz}}$

<sup>1</sup> Offset voltage does not include solder heat resistance.

<sup>2</sup> Guaranteed by design and characterization.

**ELECTRICAL CHARACTERISTICS**

$V_{SY} = \pm 15\text{ V}$ ,  $V_{CM} = 0\text{ V}$ ,  $T_A = 25^\circ\text{C}$ , unless otherwise noted.

Table 2.

Parameter	Symbol	Test Conditions/Comments	Min	Typ	Max	Unit
<b>INPUT CHARACTERISTICS</b>						
Offset Voltage (B Grade) <sup>1</sup>	$V_{OS}$	$-40^\circ\text{C} < T_A < +125^\circ\text{C}$		0.2	0.4	mV
Offset Voltage (A Grade) <sup>1</sup>	$V_{OS}$	$-40^\circ\text{C} < T_A < +125^\circ\text{C}$		0.4	0.8	mV
Offset Voltage Drift (B Grade) <sup>2</sup>	$\Delta V_{OS}/\Delta T$	$-40^\circ\text{C} < T_A < +125^\circ\text{C}$		0.5	1.8	$\mu\text{V}/^\circ\text{C}$
Offset Voltage Drift (A Grade) <sup>2</sup>	$\Delta V_{OS}/\Delta T$	$-40^\circ\text{C} < T_A < +125^\circ\text{C}$		1	8	$\mu\text{V}/^\circ\text{C}$
Input Bias Current	$I_B$	$-40^\circ\text{C} < T_A < +125^\circ\text{C}$		5	25	pA
Input Offset Current	$I_{OS}$	$-40^\circ\text{C} < T_A < +125^\circ\text{C}$		2	1.5	nA
Input Voltage Range			-12.5		20	V
Common-Mode Rejection Ratio	CMRR	$V_{CM} = -12.5\text{ V to }+12.5\text{ V}$ $-40^\circ\text{C} < T_A < +125^\circ\text{C}$	100	115	0.25	dB
Large Signal Voltage Gain	$A_{VO}$	$R_L = 2\text{ k}\Omega$ , $V_{OUT} = \pm 13.5\text{ V}$ $-40^\circ\text{C} < T_A < +125^\circ\text{C}$	96	107	+12.5	dB
Input Capacitance, Differential		$V_{CM} = 0\text{ V}$		3.1		pF
Input Capacitance, Common-Mode		$V_{CM} = 0\text{ V}$		4.8		pF
Input Resistance		$V_{CM} = 0\text{ V}$		$> 1 \times 10^{13}$		$\Omega$
<b>OUTPUT CHARACTERISTICS</b>						
Output Voltage High	$V_{OH}$	$R_L = 2\text{ k}\Omega$ $-40^\circ\text{C} < T_A < +125^\circ\text{C}$	14.8	14.9		V
		$R_L = 600\ \Omega$ $-40^\circ\text{C} < T_A < +125^\circ\text{C}$	14.65	14.47		V
Output Voltage Low	$V_{OL}$	$R_L = 2\text{ k}\Omega$ $-40^\circ\text{C} < T_A < +125^\circ\text{C}$	14.25	-14.9	-14.85	V
		$R_L = 600\ \Omega$ $-40^\circ\text{C} < T_A < +125^\circ\text{C}$	13.35	-14.68	-14.75	V
Short-Circuit Current	$I_{SC}$	$-40^\circ\text{C} < T_A < +125^\circ\text{C}$		$\pm 79$	-14.3	V
<b>POWER SUPPLY</b>						
Power Supply Rejection Ratio	PSRR	$V_{SY} = \pm 4.5\text{ V to } \pm 18\text{ V}$ $-40^\circ\text{C} < T_A < +125^\circ\text{C}$	106	125		dB
Supply Current/Amplifier	$I_{SY}$	$I_{OUT} = 0\text{ mA}$ $-40^\circ\text{C} < T_A < +125^\circ\text{C}$	103	1.6	1.85	dB
<b>DYNAMIC PERFORMANCE</b>						
Slew Rate	SR	$R_L = 2\text{ k}\Omega$	$\pm 17^2$	+25/-61		V/ $\mu\text{s}$
Gain Bandwidth Product	GBP	$V_{IN} = 5\text{ mV p-p}$ , $R_L = 2\text{ k}\Omega$ , $A_V = 100$		16.3		MHz
Unity-Gain Crossover	UGC	$V_{IN} = 5\text{ mV p-p}$ , $R_L = 2\text{ k}\Omega$ , $A_V = -10$		9.3		MHz
Phase Margin	$\phi_M$			66		Degrees
-3 dB Closed-Loop Bandwidth	-3 dB	$A_V = 1$ , $V_{IN} = 5\text{ mV p-p}$		9.50		MHz
Total Harmonic Distortion (THD) + Noise	THD + N	1 kHz, $G = +1$ , $R_L = 2\text{ k}\Omega$ , $V_{IN} = 6\text{ V rms}$		0.00006		%

Parameter	Symbol	Test Conditions/Comments	Min	Typ	Max	Unit
NOISE PERFORMANCE						
Peak-to-Peak Voltage Noise	$e_n$ p-p	0.1 Hz to 10 Hz bandwidth		0.45		$\mu$ V p-p
Voltage Noise Density	$e_n$	f = 10 Hz		14		nV/ $\sqrt$ Hz
		f = 100 Hz		8.5		nV/ $\sqrt$ Hz
		f = 1 kHz		7.3		nV/ $\sqrt$ Hz
		f = 10 kHz		7.3		nV/ $\sqrt$ Hz

<sup>1</sup> Offset voltage does not include solder heat resistance.

<sup>2</sup> Guaranteed by design and characterization.

## ABSOLUTE MAXIMUM RATINGS

Table 3.

Parameter	Rating
Supply Voltage	$\pm 18$ V
Input Voltage	$\pm V_S$
Output Short-Circuit Duration to GND	Observe derating curves
Storage Temperature Range	$-65^{\circ}\text{C}$ to $+150^{\circ}\text{C}$
Operating Temperature Range	$-40^{\circ}\text{C}$ to $+125^{\circ}\text{C}$
Junction Temperature Range	$-65^{\circ}\text{C}$ to $+150^{\circ}\text{C}$
Lead Temperature (Soldering, 10 sec)	$300^{\circ}\text{C}$
Electrostatic Discharge (Human Body Model)	2500 V

Stresses above those listed under Absolute Maximum Ratings may cause permanent damage to the device. This is a stress rating only; functional operation of the device at these or any other conditions above those indicated in the operational section of this specification is not implied. Exposure to absolute maximum rating conditions for extended periods may affect device reliability.

Table 4. Thermal Resistance

Package Type	$\theta_{JA}^1$	$\theta_{JC}$	Unit
8-Lead MSOP (RM-8)	142	45	$^{\circ}\text{C}/\text{W}$
8-Lead SOIC_N (R-8)	120	43	$^{\circ}\text{C}/\text{W}$
8-Lead LFCSP_VD (CP-8-9)	57	12	$^{\circ}\text{C}/\text{W}$

<sup>1</sup>  $\theta_{JA}$  is specified for worst-case conditions, that is,  $\theta_{JA}$  is specified for device soldered in circuit board for surface-mount packages.

### ESD CAUTION



**ESD (electrostatic discharge) sensitive device.** Charged devices and circuit boards can discharge without detection. Although this product features patented or proprietary protection circuitry, damage may occur on devices subjected to high energy ESD. Therefore, proper ESD precautions should be taken to avoid performance degradation or loss of functionality.

# TYPICAL PERFORMANCE CHARACTERISTICS

T<sub>A</sub> = 25°C, unless otherwise noted.

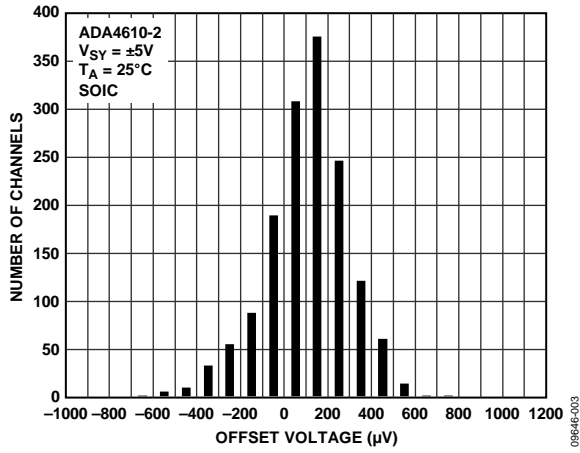

Figure 3. Input Offset Voltage Distribution

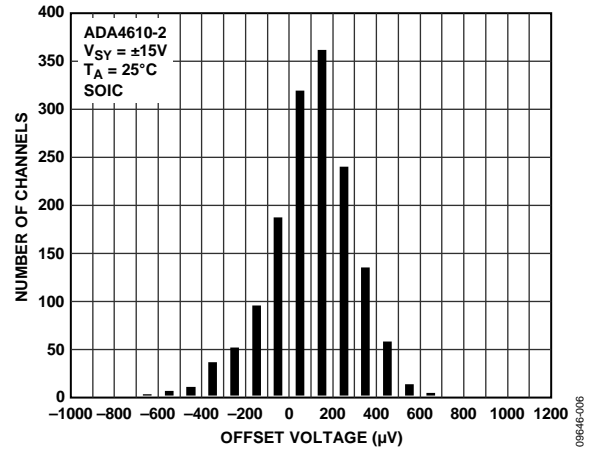

Figure 6. Input Offset Voltage Distribution

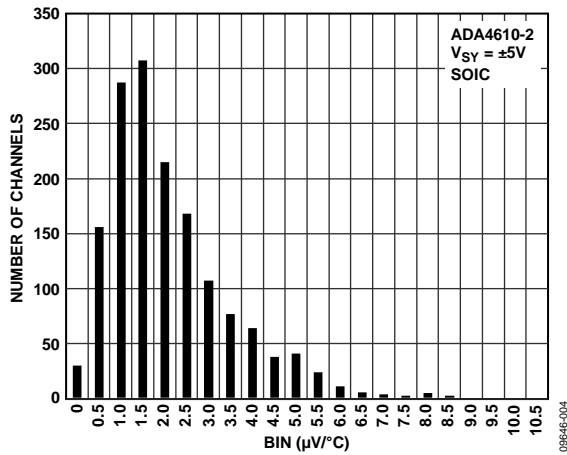

Figure 4. T<sub>c</sub>V<sub>os</sub> Distribution

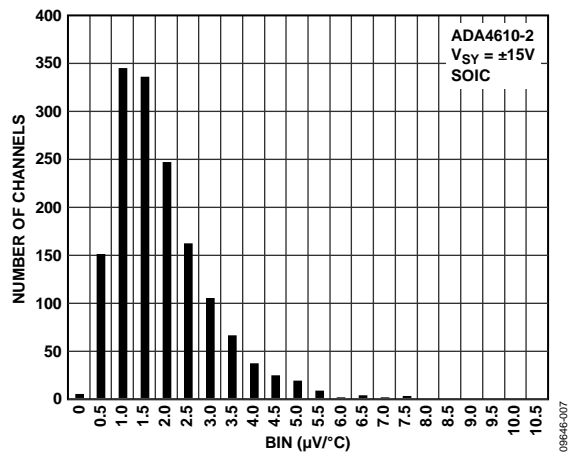

Figure 7. T<sub>c</sub>V<sub>os</sub> Distribution

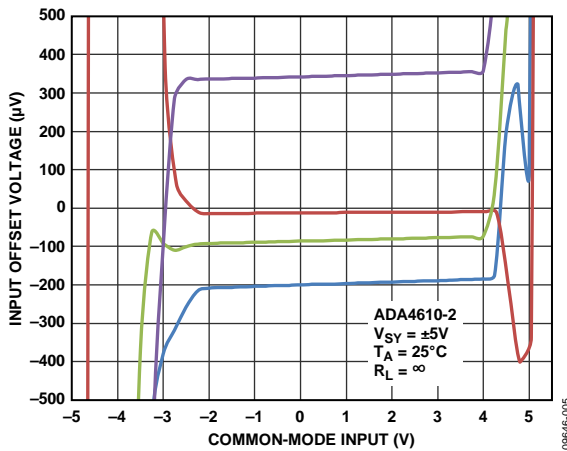

Figure 5. Input Offset Voltage vs. Common-Mode Input Voltage

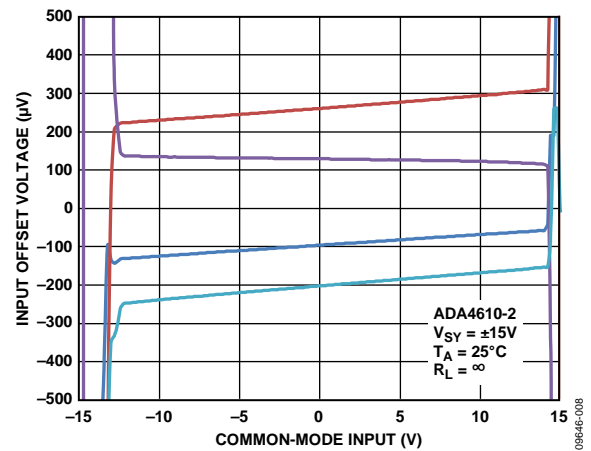

Figure 8. Input Offset Voltage vs. Common-Mode Input Voltage

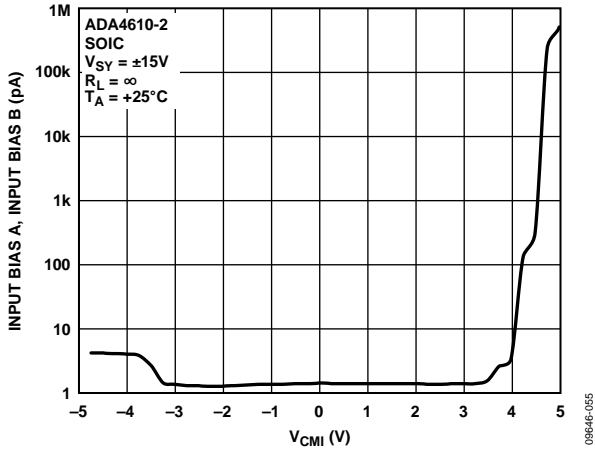

Figure 9. Input Bias Current vs. Common Mode Voltage

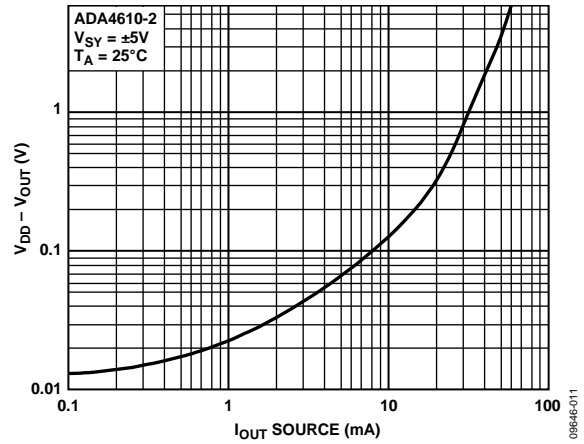

Figure 12. Dropout Voltage vs. Source Current

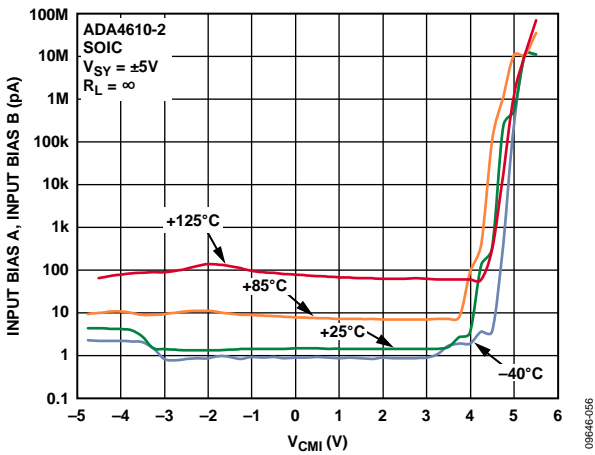

Figure 10. Input Bias Current vs. Common Mode Voltage and Temperature

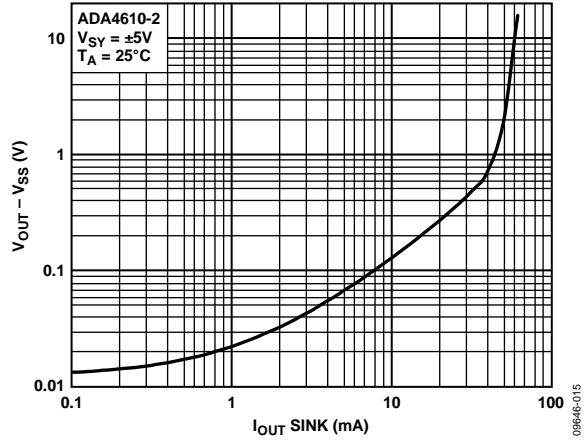

Figure 13. Dropout Voltage vs. Sink Current

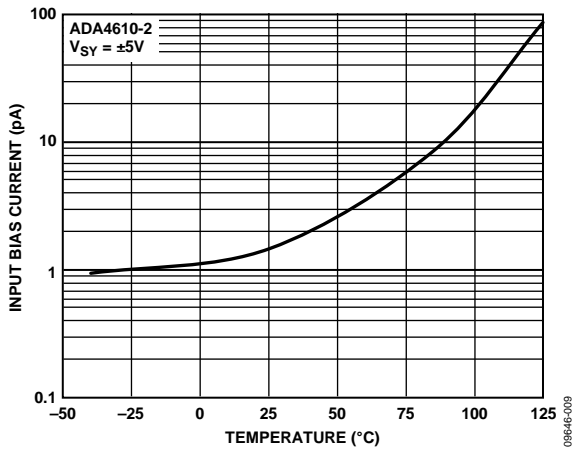

Figure 11. Input Bias Current vs. Temperature

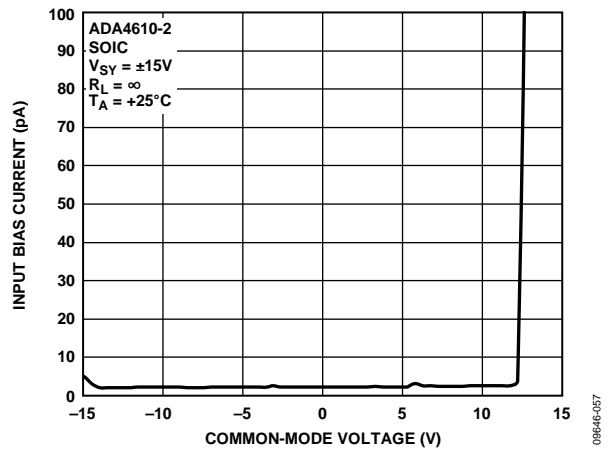

Figure 14. Input Bias Current vs. Common-Mode Voltage



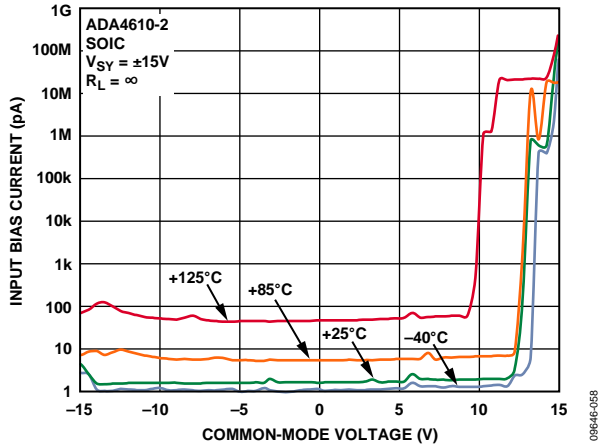

Figure 15. Input Bias Current vs. Common-Mode Voltage and Temperature

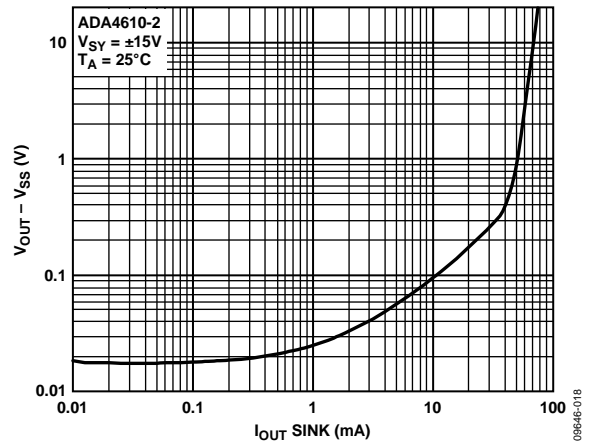

Figure 18. Dropout Voltage vs. Sink Current

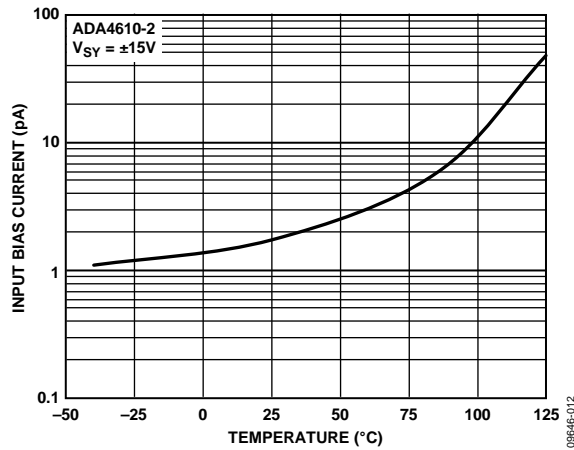

Figure 16. Input Bias Current vs. Temperature

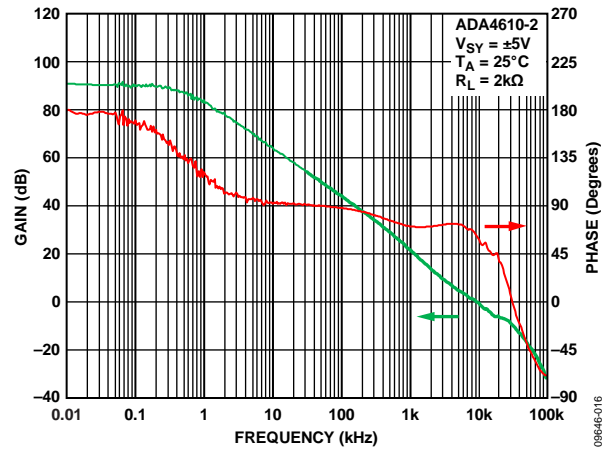

Figure 19. Open-Loop Gain and Phase vs. Frequency

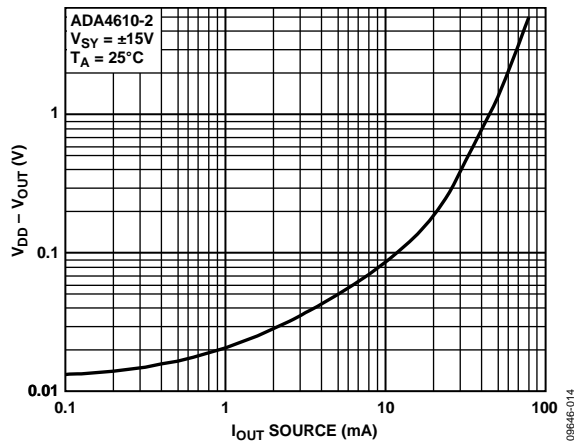

Figure 17. Dropout Voltage vs. Source Current

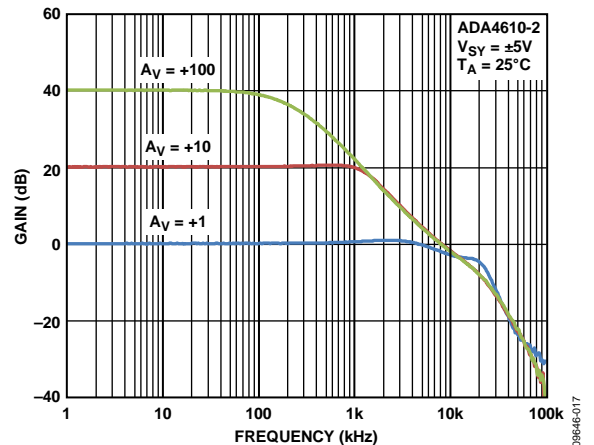

Figure 20. Closed-Loop Gain vs. Frequency

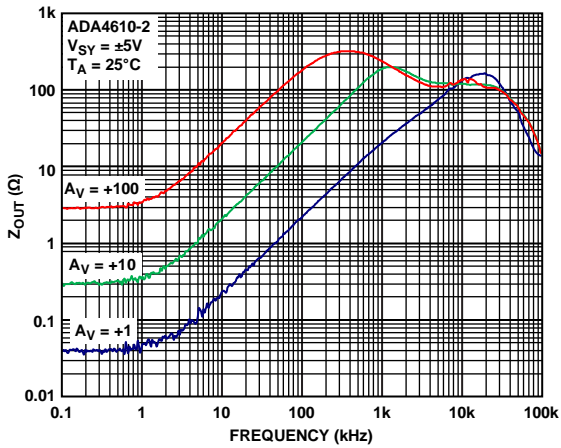

Figure 21. Closed-Loop Output Impedance vs. Frequency

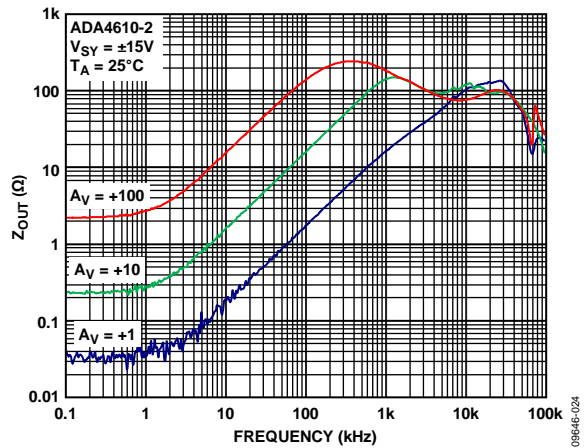

Figure 24. Closed-Loop Output Impedance vs. Frequency

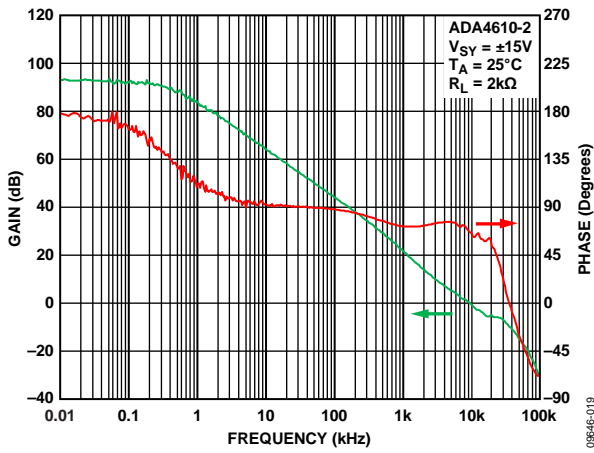

Figure 22. Open-Loop Gain and Phase vs. Frequency

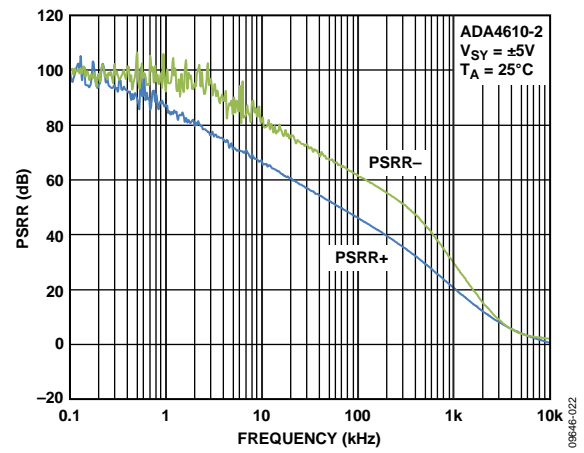

Figure 25. PSRR vs. Frequency

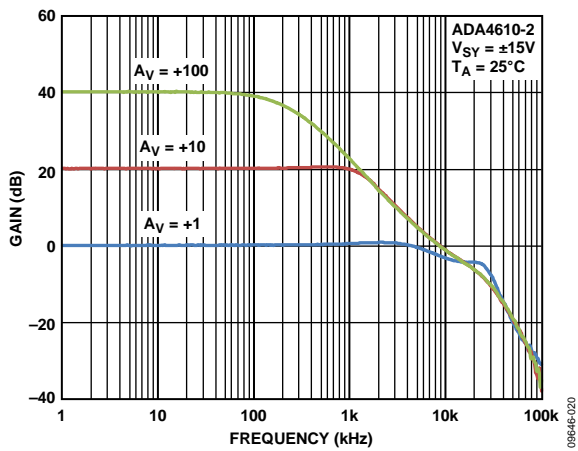

Figure 23. Closed-Loop Gain vs. Frequency

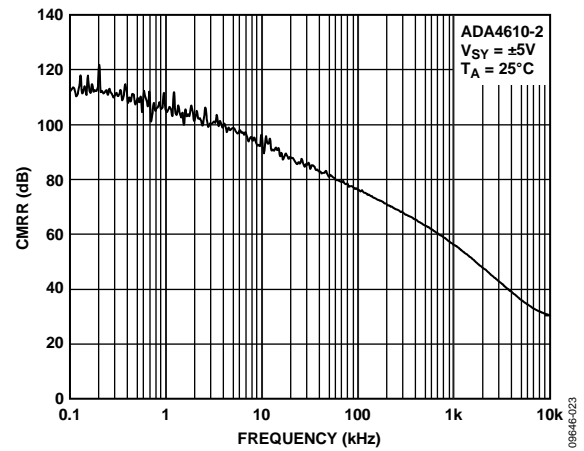

Figure 26. CMRR vs. Frequency

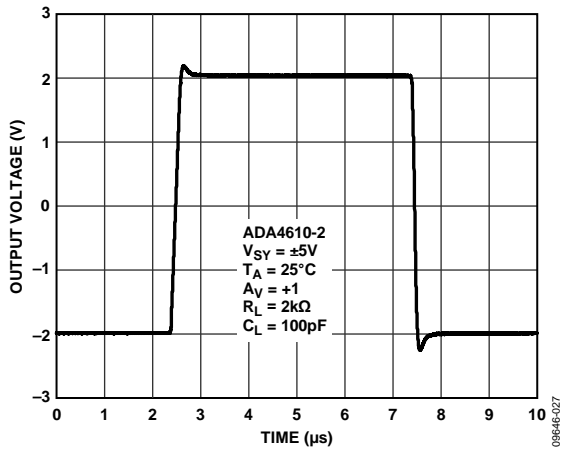

Figure 27. Large Signal Transient Response

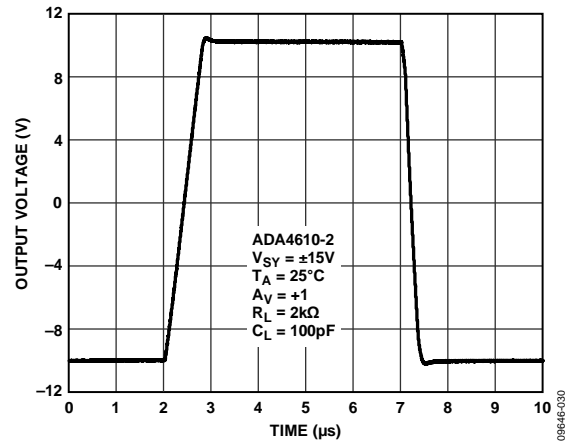

Figure 30. Large Signal Transient Response

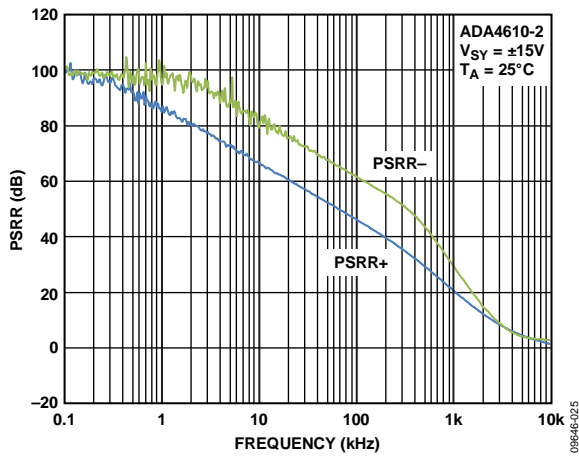

Figure 28. PSRR vs. Frequency

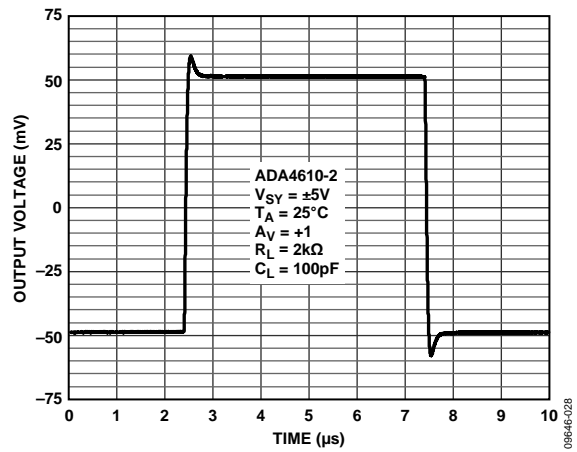

Figure 31. Small Signal Transient Response

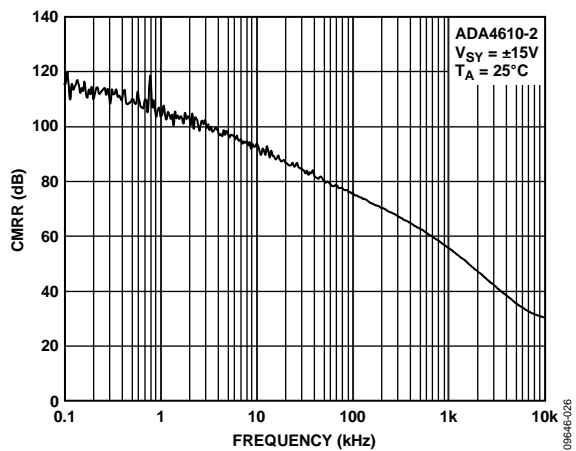

Figure 29. CMRR vs. Frequency

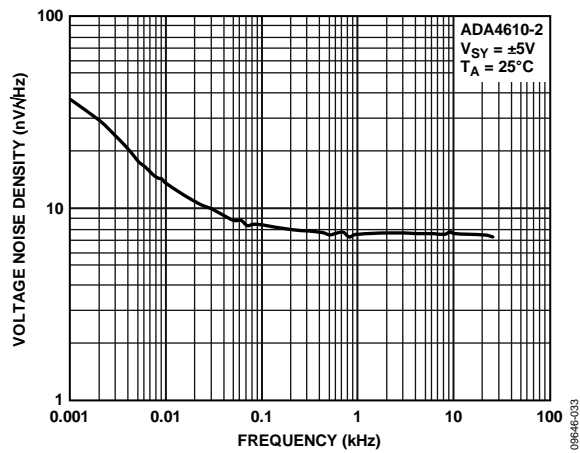

Figure 32. Voltage Noise Density

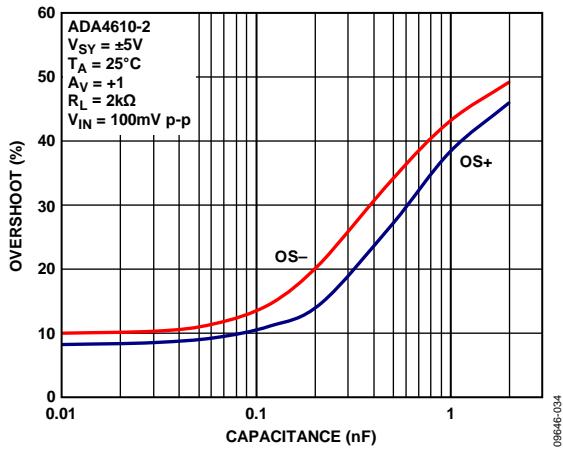

Figure 33. Overshoot vs. Load Capacitance

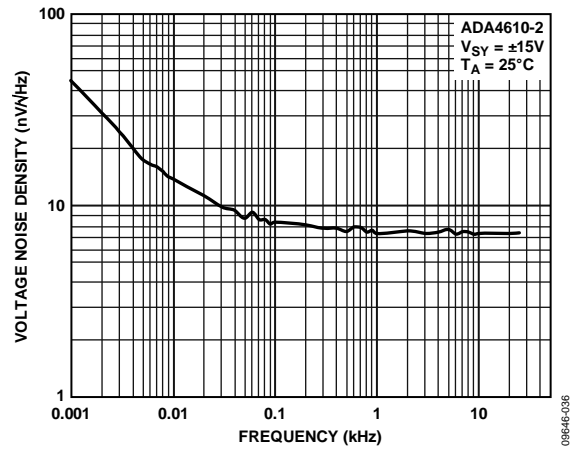

Figure 35. Voltage Noise Density

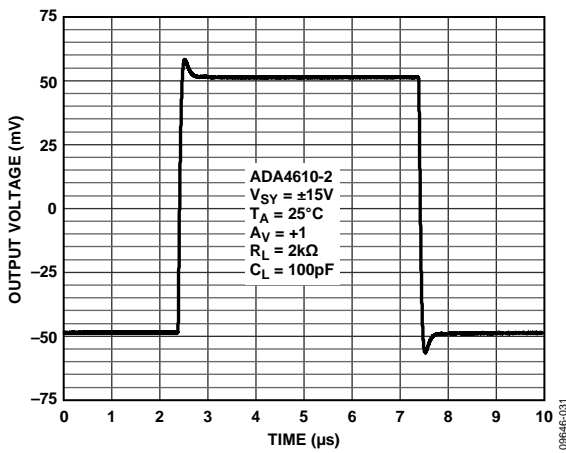

Figure 34. Small Signal Transient Response

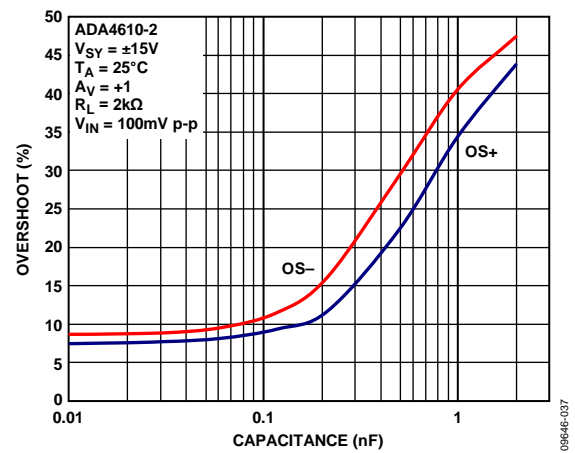

Figure 36. Overshoot vs. Load Capacitance

COMPARATIVE VOLTAGE AND VARIABLE VOLTAGE GRAPHS

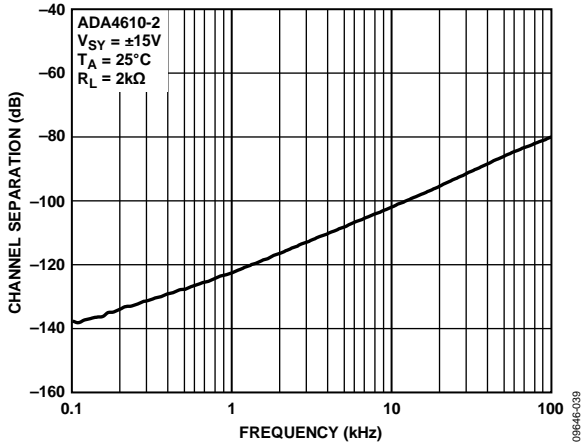

Figure 37. Channel Separation

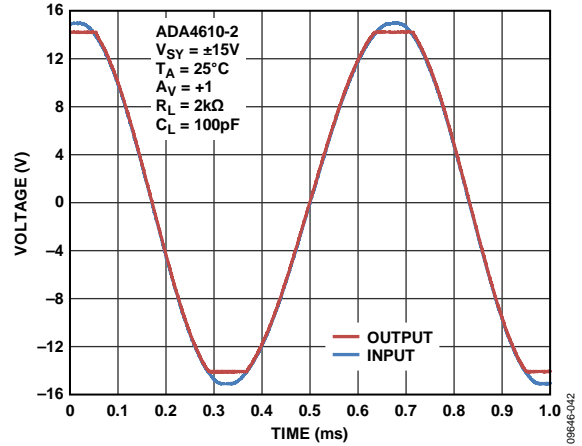

Figure 40. No Phase Reversal

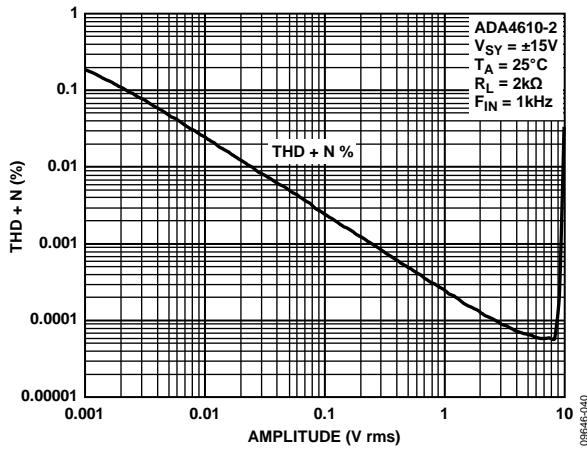

Figure 38. THD + N vs. Amplitude

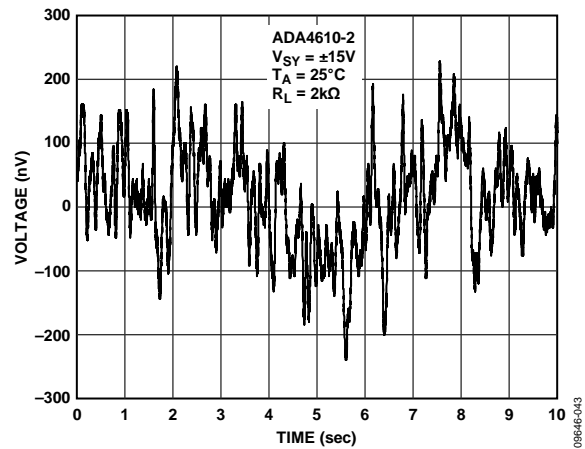

Figure 41. Voltage Noise, 0.1 Hz to 10 Hz

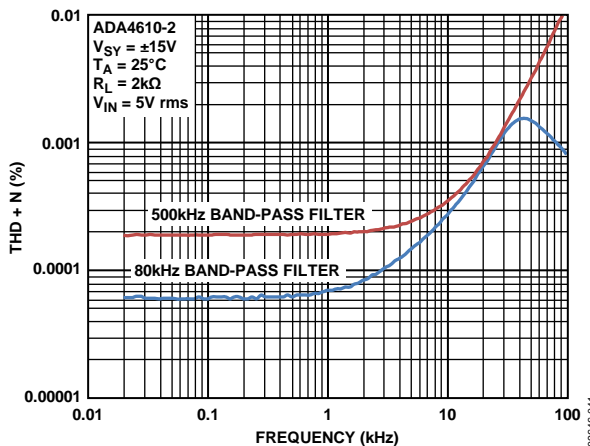

Figure 39. THD + N vs. Frequency

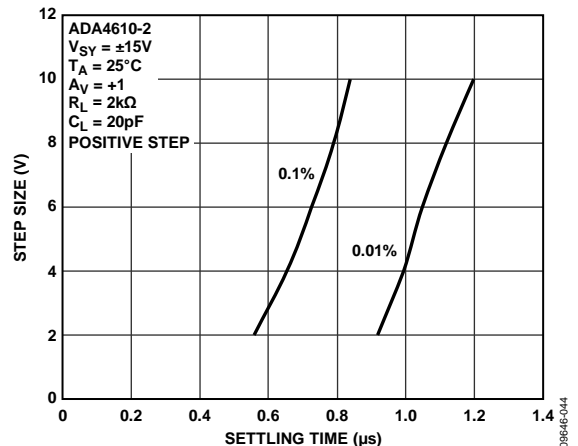

Figure 42. Positive Step Settling Time

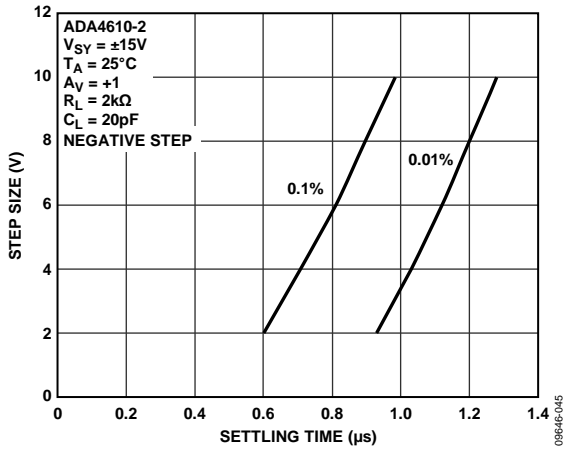

Figure 43 Negative Step Settling Time

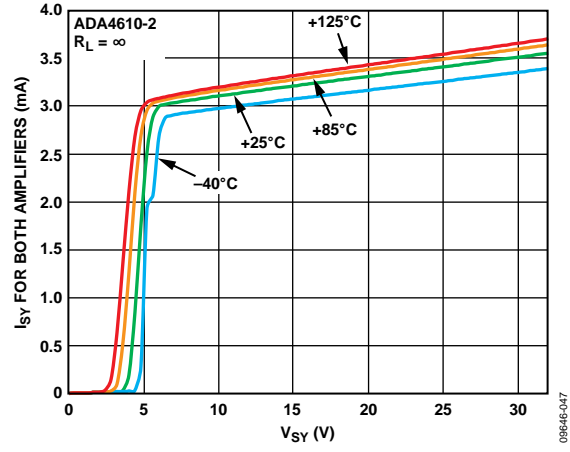

Figure 44. Supply Current vs. Supply Voltage and Temperature

# APPLICATIONS INFORMATION

## COMPARATOR OPERATION

Although op amps are quite different from comparators, occasionally an unused section of a dual or a quad op amp may be used as a comparator; however, this is not recommended for any rail-to-rail output op amp. For rail-to-rail output op amps, the output stage is generally a ratioed current mirror with bipolar or MOSFET transistors. With the part operating open loop, the second stage increases the current drive to the ratioed mirror to close the loop. However, the second stage cannot close the loop, which results in an increase in supply current. With the op amp configured as a comparator, the supply current can be significantly higher (see Figure 45). Configuring an unused section as a voltage follower with the noninverting input connected to a voltage within the input voltage range is recommended. The ADA4610-2 has a unique output stage design that reduces the excess supply current, but does not entirely eliminate this effect when the op amp is operating open loop.

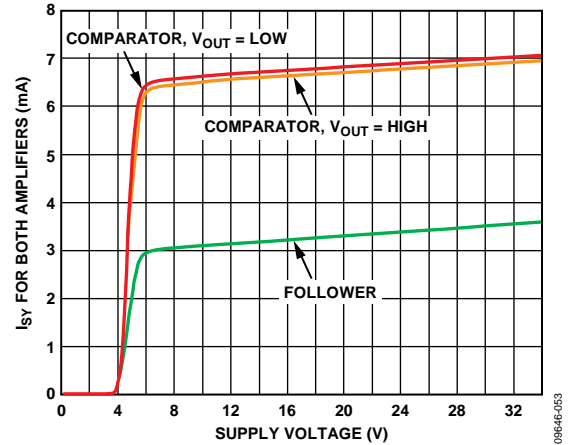

Figure 45. Supply Current vs. Supply Voltage

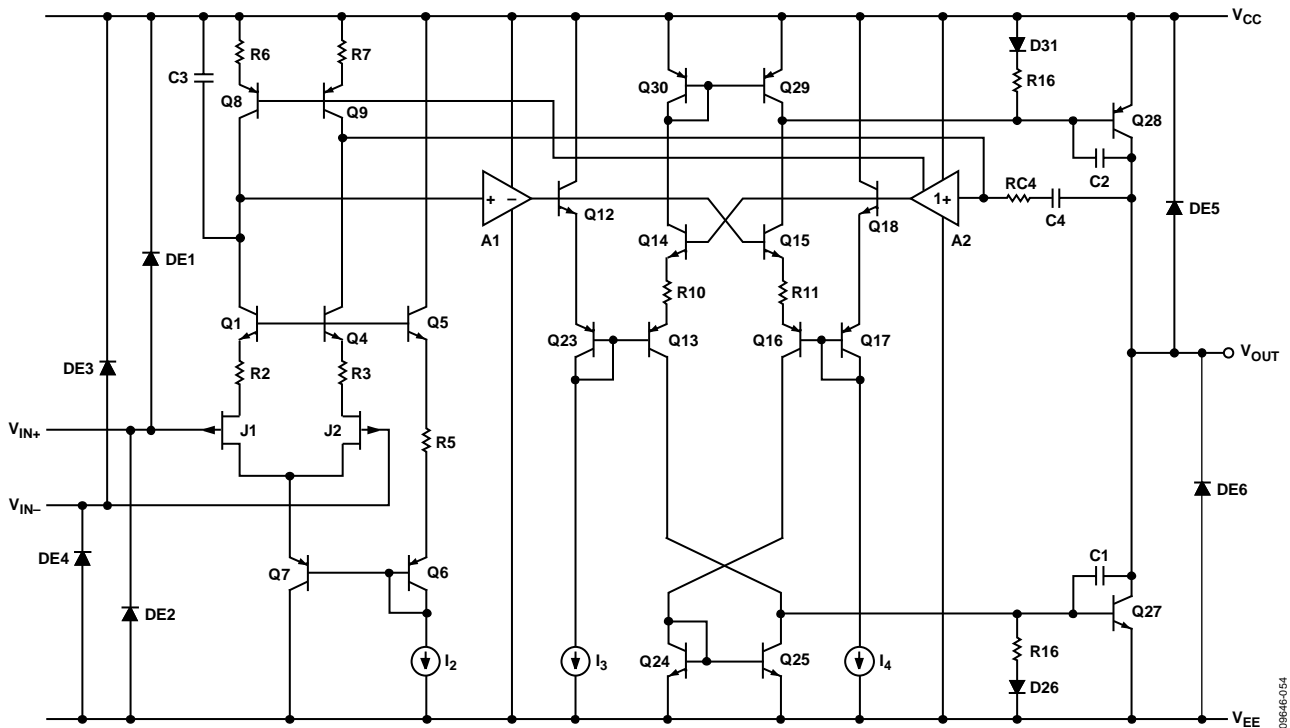
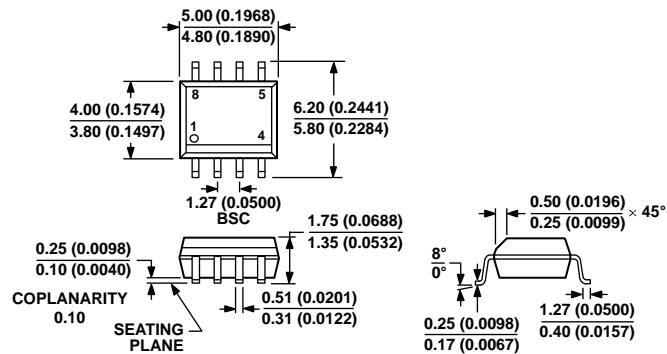

Figure 46. Simplified Schematic

OUTLINE DIMENSIONS



COMPLIANT TO JEDEC STANDARDS MS-012-AA  
 CONTROLLING DIMENSIONS ARE IN MILLIMETERS; INCH DIMENSIONS  
 (IN PARENTHESES) ARE ROUNDED-OFF MILLIMETER EQUIVALENTS FOR  
 REFERENCE ONLY AND ARE NOT APPROPRIATE FOR USE IN DESIGN.

Figure 47. 8-Lead Standard Small Outline Package [SOIC\_N]  
 Narrow Body (R-8)  
 Dimensions shown in millimeters and (inches)

012407-A

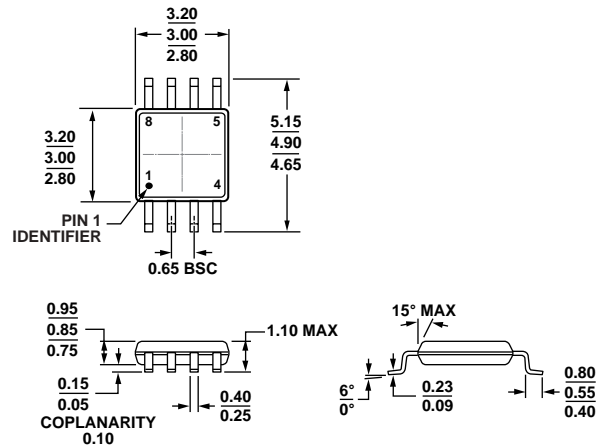

COMPLIANT TO JEDEC STANDARDS MO-187-AA  
 Figure 48. 8-Lead Mini Small Outline Package [MSOP]  
 (RM-8)  
 Dimensions shown in millimeters

10-07-2009-B



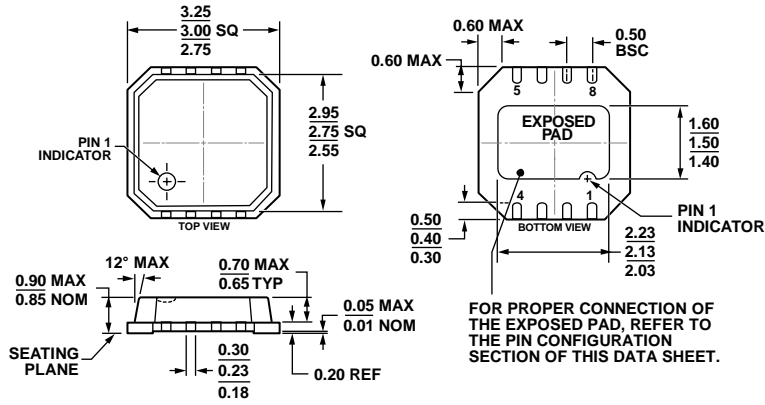

Figure 49. 8-Lead Lead Frame Chip Scale Package [LFCSP\_VD]  
 3 mm × 3 mm Body, Very Thin, Dual Lead  
 (CP-8-9)  
 Dimensions shown in millimeters

04-06-2012-A

**ORDERING GUIDE**

Model <sup>1</sup>	Temperature Range	Package Description	Package Option	Branding
ADA4610-2ACPZ-R7	-40°C to +125°C	8-Lead LFCSP_VD	CP-8-9	A2U
ADA4610-2ACPZ-RL	-40°C to +125°C	8-Lead LFCSP_VD	CP-8-9	A2U
ADA4610-2ARMZ	-40°C to +125°C	8-Lead MSOP	RM-8	A2U
ADA4610-2ARMZ-R7	-40°C to +125°C	8-Lead MSOP	RM-8	A2U
ADA4610-2ARMZ-RL	-40°C to +125°C	8-Lead MSOP	RM-8	A2U
ADA4610-2ARZ	-40°C to +125°C	8-Lead SOIC_N	R-8	
ADA4610-2ARZ-R7	-40°C to +125°C	8-Lead SOIC_N	R-8	
ADA4610-2ARZ-RL	-40°C to +125°C	8-Lead SOIC_N	R-8	
ADA4610-2BRZ	-40°C to +125°C	8-Lead SOIC_N	R-8	
ADA4610-2BRZ-R7	-40°C to +125°C	8-Lead SOIC_N	R-8	
ADA4610-2BRZ-RL	-40°C to +125°C	8-Lead SOIC_N	R-8	

<sup>1</sup> Z = RoHS Compliant Part.

**NOTES**

**NOTES**

**NOTES**