

FEATURES

- Sixth-order filters**
- Transparent input sync tip clamp**
- 1 dB bandwidth of 26 MHz typical for HD**
- HD rejection @ 75 MHz: 48 dB typical**
- NTSC differential gain: 0.19%**
- NTSC differential phase: 0.76°**
- Rail-to-rail outputs**
- Low quiescent current: 32 mA typical**
- Disable feature**
- Output dc offset**

APPLICATIONS

- Set-top boxes**
- DVD players and recorders**
- HDTVs**
- Projectors**
- Personal video recorders**

GENERAL DESCRIPTION

The ADA4420-6 is a low cost video reconstruction filter specifically designed for consumer applications. It consists of six independent sixth-order Butterworth filters/buffers, three for standard definition (Y/C or CVBS) and three for high definition component signals (YPbPr or RGB).

The ADA4420-6 operates from a single 5 V supply and has a low quiescent current of 32 mA, making it ideal for applications where power consumption is critical. A disable feature allows for further power conservation by reducing the supply current to less than 8 μ A typical when the device is not in use.

FUNCTIONAL BLOCK DIAGRAM

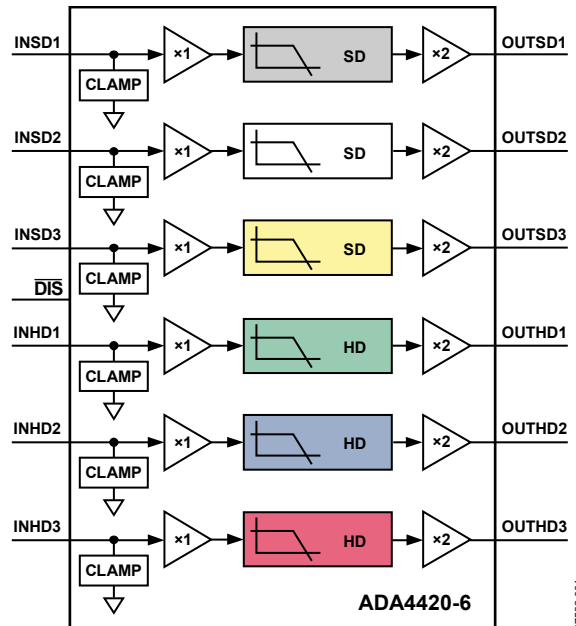

Figure 1.

Each channel features a transparent sync tip clamp, allowing ac coupling of the inputs without requiring dc restoration.

The output drivers on the ADA4420-6 have rail-to-rail output capabilities with 6 dB gain. A built-in offset of 250 mV allows the outputs to be dc-coupled, eliminating the need for large coupling capacitors. Each output is capable of driving two 75 Ω doubly terminated cables.

The ADA4420-6 is available in a 16-lead QSOP and operates in the extended industrial temperature range of -40°C to $+85^{\circ}\text{C}$.

Rev. 0

Information furnished by Analog Devices is believed to be accurate and reliable. However, no responsibility is assumed by Analog Devices for its use, nor for any infringements of patents or other rights of third parties that may result from its use. Specifications subject to change without notice. No license is granted by implication or otherwise under any patent or patent rights of Analog Devices. Trademarks and registered trademarks are the property of their respective owners.

One Technology Way, P.O. Box 9106, Norwood, MA 02062-9106, U.S.A.
 Tel: 781.329.4700 www.analog.com
 Fax: 781.461.3113 ©2008 Analog Devices, Inc. All rights reserved.

TABLE OF CONTENTS

Features	1	Typical Performance Characteristics	6
Applications	1	Test Circuits	9
General Description	1	Applications Information	10
Functional Block Diagram	1	Overview	10
Revision History	2	Disable	10
Specifications	3	Input and Output Coupling	10
Absolute Maximum Ratings	4	Printed Circuit Board (PCB) Layout	10
Thermal Resistance	4	Video Encoder Reconstruction Filter	10
Maximum Power Dissipation	4	Outline Dimensions	12
ESD Caution	4	Ordering Guide	12
Pin Configuration and Function Descriptions	5		

REVISION HISTORY

8/08—Revision 0: Initial Version

SPECIFICATIONS

$V_S = 5\text{ V}$, $T_A = 25^\circ\text{C}$, $V_O = 2.0\text{ V p-p}$, $R_L = 150\ \Omega$, dc-coupled inputs, ac-coupled outputs, unless otherwise noted. See Figure 17, Figure 18, and Figure 19 for the test circuits.

Table 1.

Parameter	Test Conditions/Comments	Min	Typ	Max	Unit
OVERALL PERFORMANCE					
DC Voltage Gain	All channels	5.8	6.0	6.2	dB
Input Voltage Range, All Inputs			0 to 2.1		V
Output Voltage Range, All Outputs			0.25 to 4.6		V
Linear Output Current per Channel			30		mA
Filter Input Bias Current			1		μA
SD CHANNEL DYNAMIC PERFORMANCE					
-1 dB Bandwidth			8.6		MHz
-3 dB Bandwidth		8.5	10		MHz
Out-of-Band Rejection	$f = 27\text{ MHz}$	42	45		dB
Crosstalk	$f = 1\text{ MHz}$		-68		dB
Total Harmonic Distortion	$f = 1\text{ MHz}$, $V_O = 1.4\text{ V p-p}$, dc-coupled outputs		0.02		%
Signal-to-Noise Ratio	$f = 100\text{ kHz to }6\text{ MHz}$, unweighted		70		dB
Propagation Delay			57		ns
Group Delay Variation	$f = 100\text{ kHz to }5\text{ MHz}$		16		ns
Differential Gain	NTSC; ac-coupled inputs, dc-coupled outputs; see Figure 18		0.19		%
Differential Phase	NTSC; ac-coupled inputs, dc-coupled outputs; see Figure 18		0.76		Degrees
HD CHANNEL DYNAMIC PERFORMANCE					
-1 dB Bandwidth			26		MHz
-3 dB Bandwidth		27	31		MHz
Out-of-Band Rejection	$f = 75\text{ MHz}$	43	48		dB
Crosstalk	$f = 1\text{ MHz}$		-68		dB
Total Harmonic Distortion	$f = 10\text{ MHz}$, $V_O = 1.4\text{ V p-p}$, dc-coupled outputs		0.57		%
Signal-to-Noise Ratio	$f = 100\text{ kHz to }30\text{ MHz}$, unweighted		66		dB
Propagation Delay			15		ns
Group Delay Variation	$f = 100\text{ kHz to }30\text{ MHz}$		11		ns
DC CHARACTERISTICS					
Operating Voltage			4.75 to 5.25		V
Quiescent Supply Current	Active, $\overline{\text{DIS}} = 1$		32	36	mA
	Disabled, $\overline{\text{DIS}} = 0$		7	13	μA
PSRR	HD channel, referred to output	35	41		dB
	SD channel, referred to output	40	45		dB
Output DC Offset	All channels	135	250	375	mV
DISABLE Assert Voltage				1.9	V
DISABLE Assert Time			20		ns
DISABLE De-Assert Time			450		ns
DISABLE Input Bias Current	Disabled, $\overline{\text{DIS}} = 0$		-6.8		μA
Input-to-Output Isolation	Disabled, $\overline{\text{DIS}} = 0$, $f = 5\text{ MHz}$		-96		dB

ABSOLUTE MAXIMUM RATINGS

Table 2.

Parameter	Rating
Supply Voltage	5.5 V
Power Dissipation	See Figure 2
Storage Temperature Range	-65°C to +125°C
Operating Temperature Range	-40°C to +85°C
Lead Temperature (Soldering, 10 sec)	300°C
Junction Temperature	150°C

Stresses above those listed under Absolute Maximum Ratings may cause permanent damage to the device. This is a stress rating only; functional operation of the device at these or any other conditions above those indicated in the operational section of this specification is not implied. Exposure to absolute maximum rating conditions for extended periods may affect device reliability.

THERMAL RESISTANCE

θ_{JA} is specified for the device soldered to a high thermal conductivity 4-layer (2s2p) circuit board, as described in EIA/JESD 51-7.

Table 3.

Package Type	θ_{JA}	θ_{JC}	Unit
16-Lead QSOP	105	23	°C/W

MAXIMUM POWER DISSIPATION

The maximum safe power dissipation in the ADA4420-6 package is limited by the associated rise in junction temperature (T_J) on the die. At approximately 150°C, which is the glass transition temperature, the plastic changes its properties. Even temporarily exceeding this temperature limit can change the stresses that the package exerts on the die, permanently shifting the parametric performance of the ADA4420-6. Exceeding a junction temperature of 150°C for an extended time can result in changes in the silicon devices, potentially causing failure.

The power dissipated in the package (P_D) is the sum of the quiescent power dissipation and the power dissipated in the package due to the load drive for all outputs. The quiescent power is the voltage between the supply pins (V_S) times the quiescent current (I_S). The power dissipated due to load drive depends on the particular application. For each output, the power due to load drive is calculated by multiplying the load current by the associated voltage drop across the device. The power dissipated due to the loads is equal to the sum of the power dissipations due to each individual load. RMS voltages and currents must be used in these calculations.

Airflow increases heat dissipation, effectively reducing θ_{JA} . Figure 2 shows the maximum power dissipation in the package vs. the ambient temperature for the 16-lead QSOP (105°C/W) on a JEDEC standard 4-layer board. θ_{JA} values are approximate.

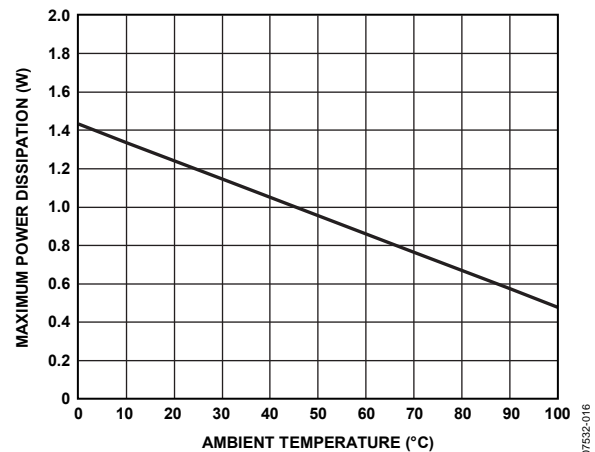

Figure 2. Maximum Power Dissipation vs. Ambient Temperature for a 4-Layer Board

ESD CAUTION



ESD (electrostatic discharge) sensitive device. Charged devices and circuit boards can discharge without detection. Although this product features patented or proprietary protection circuitry, damage may occur on devices subjected to high energy ESD. Therefore, proper ESD precautions should be taken to avoid performance degradation or loss of functionality.

PIN CONFIGURATION AND FUNCTION DESCRIPTIONS

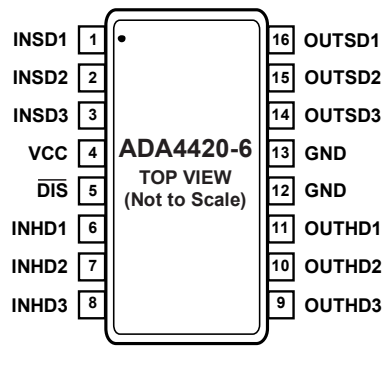

Figure 3. Pin Configuration

Table 4. Pin Function Descriptions

Pin No.	Mnemonic	Description
1	INSD1	Standard Definition Input 1
2	INSD2	Standard Definition Input 2
3	INSD3	Standard Definition Input 3
4	VCC	Power Supply
5	$\overline{\text{DIS}}$	Disable/Power-Down Input
6	INHD1	High Definition Input 1
7	INHD2	High Definition Input 2
8	INHD3	High Definition Input 3
9	OUTHD3	High Definition Output 3
10	OUTHD2	High Definition Output 2
11	OUTHD1	High Definition Output 1
12	GND	Ground
13	GND	Ground
14	OUTSD3	Standard Definition Output 3
15	OUTSD2	Standard Definition Output 2
16	OUTSD1	Standard Definition Output 1

TYPICAL PERFORMANCE CHARACTERISTICS

$V_S = 5.0\text{ V}$, $T_A = 25^\circ\text{C}$, $V_O = 2.0\text{ V p-p}$, $R_L = 150\ \Omega$, dc-coupled inputs, ac-coupled outputs, unless otherwise noted. See Figure 17, Figure 18, and Figure 19 for the test circuits.

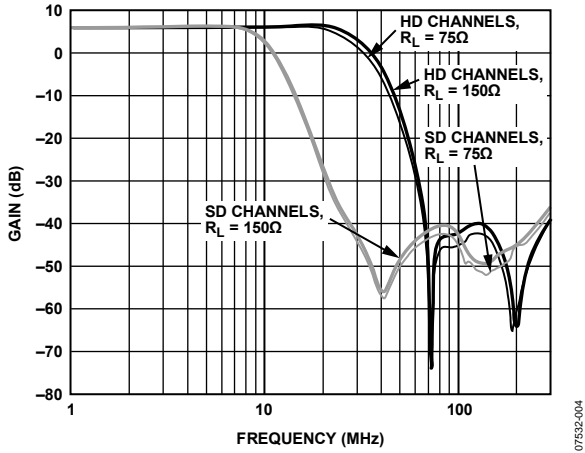

Figure 4. Frequency Response vs. Load (R_L)

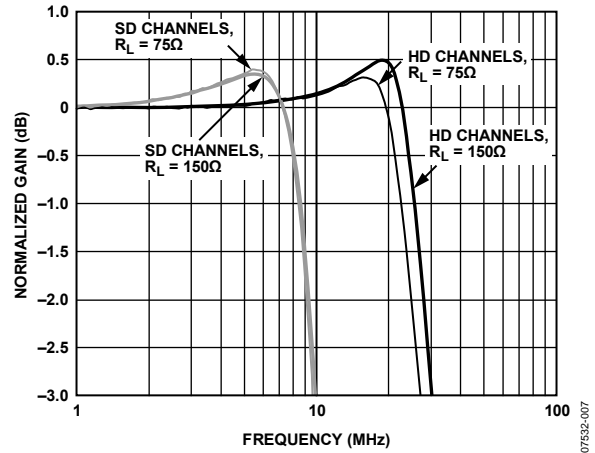

Figure 7. Flatness vs. Load (R_L)

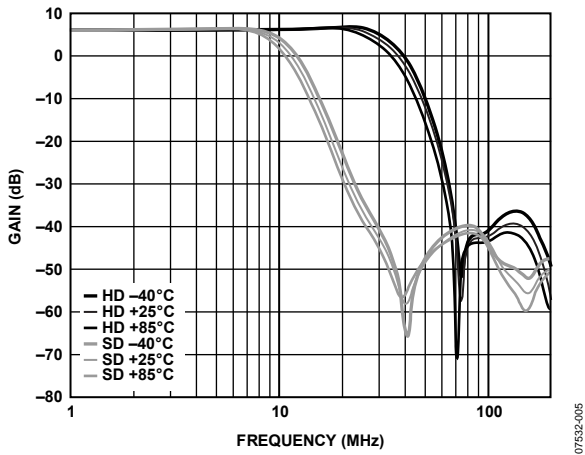

Figure 5. Frequency Response vs. Temperature

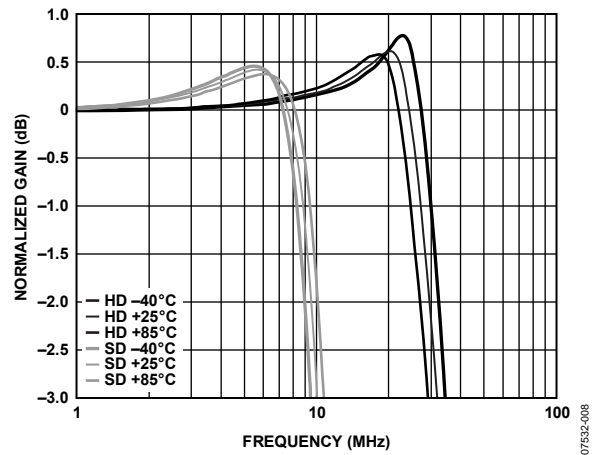

Figure 8. Flatness vs. Temperature

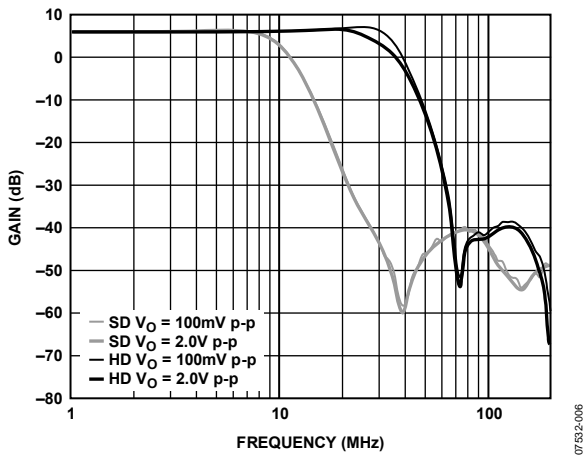

Figure 6. Frequency Response vs. Amplitude

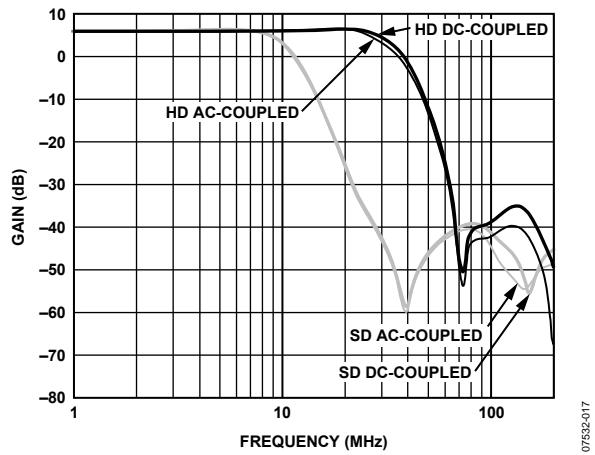

Figure 9. Frequency Response vs. Output Coupling

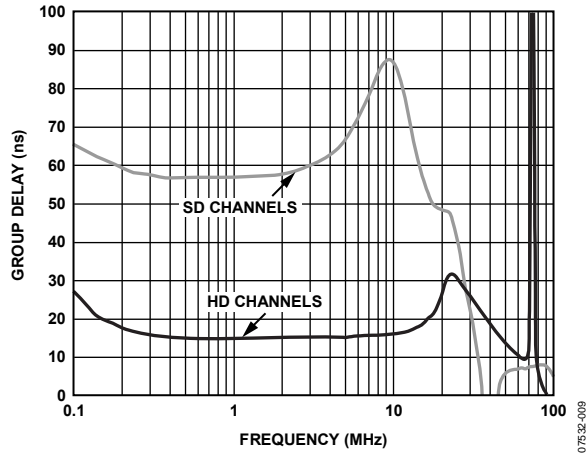

Figure 10. Group Delay vs. Frequency

07632-009

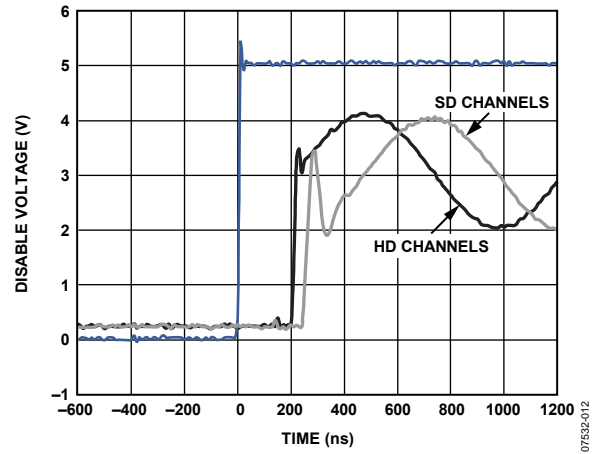

Figure 12. Enable Turn-On Time

07632-012

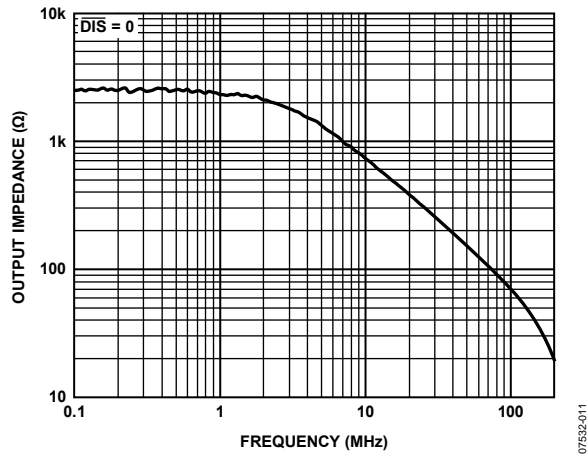

Figure 11. Output Impedance vs. Frequency

07632-011

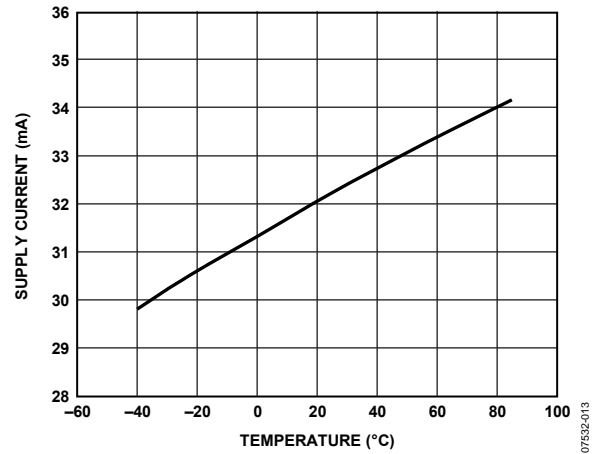

Figure 13. Supply Current vs. Temperature

07632-013

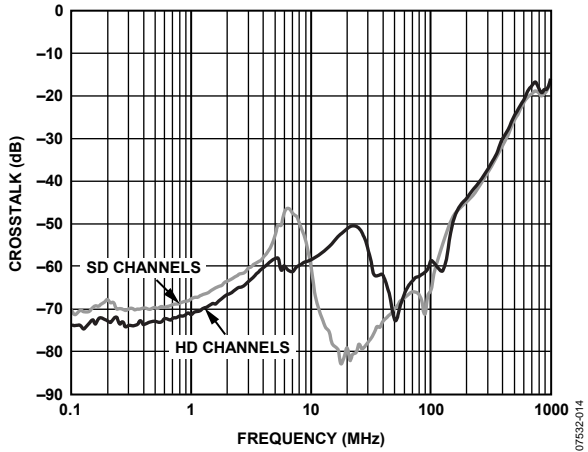

Figure 14. Crosstalk vs. Frequency

07532-014

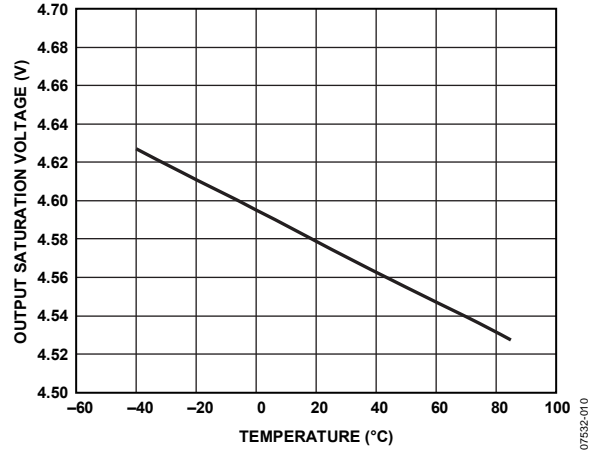

Figure 16. Output Saturation Voltage vs. Temperature

07532-010

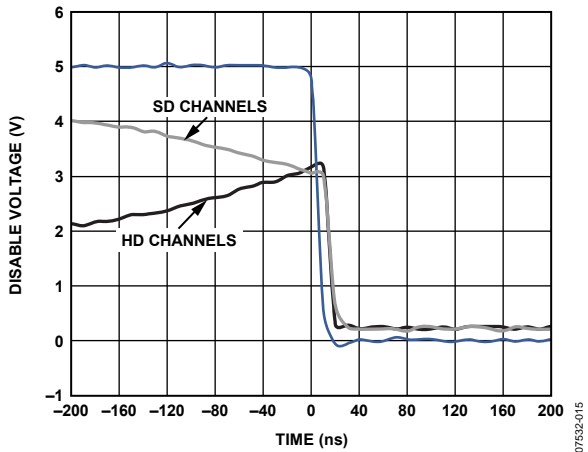

Figure 15. Disable Turn-Off Time

07532-015

TEST CIRCUITS

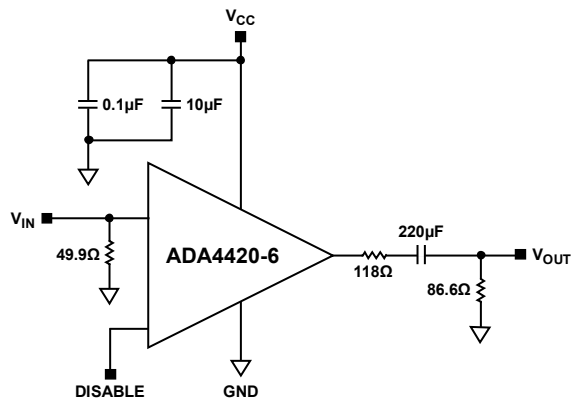

Figure 17. DC-Coupled Input, AC-Coupled Output

07532-018

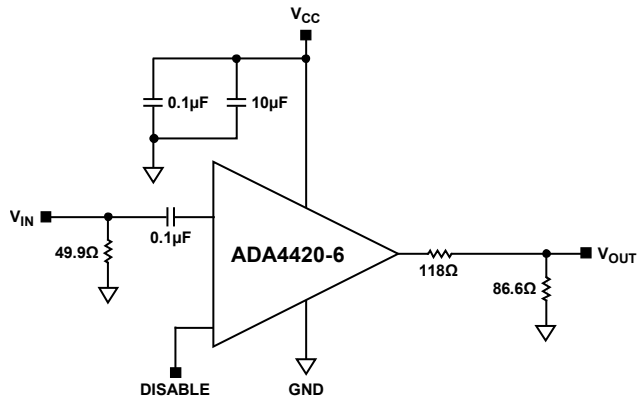

Figure 18. AC-Coupled Input, DC-Coupled Output

07532-019

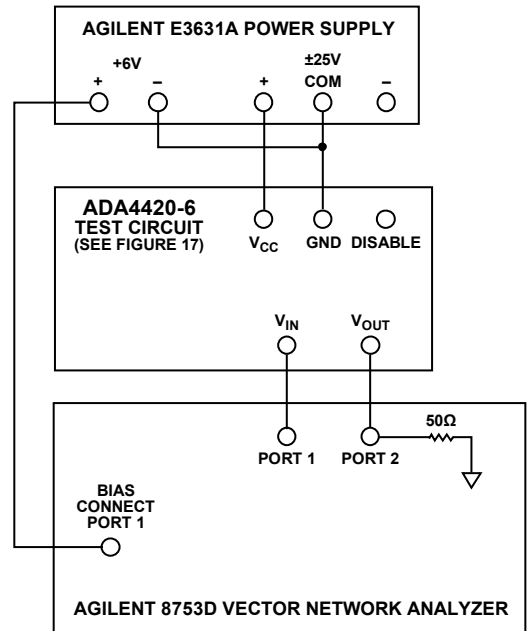

Figure 19. Test Circuit for Frequency Response and Group Delay

07532-020

APPLICATIONS INFORMATION

OVERVIEW

With its high impedance inputs and high output drive, the ADA4420-6 is ideally suited to video reconstruction and anti-alias filtering applications. The high impedance inputs give designers flexibility with regard to how the input signals are terminated. Devices with DAC current source outputs that feed the ADA4420-6 can be loaded in whatever resistance provides the best performance, and devices with voltage outputs can be optimally terminated as well. The ADA4420-6 outputs can each drive up to two source-terminated, 75 Ω loads and, therefore, can directly drive the outputs from set-top boxes and DVDs without the need for a separate output buffer.

DISABLE

The ADA4420-6 includes a disable feature that can be used to save power when a particular device is not in use. When disabled, the ADA4420-6 typically draws only 7 μA from the supply. The disable feature is asserted by pulling the $\overline{\text{DIS}}$ pin low.

Table 5 summarizes the operation of the disable feature.

Table 5. Disable Function

$\overline{\text{DIS}}$ Pin Connection	Status
V _{CC} or floating	Enabled
GND	Disabled

INPUT AND OUTPUT COUPLING

Inputs to the ADA4420-6 can be ac- or dc-coupled. For dc-coupled inputs, the signal must be completely contained within the input range of 0 V to 2.1 V. When using ac-coupled inputs, the lowest point of the signal is clamped to approximately 0 V. The ADA4420-6 outputs can be either ac- or dc-coupled.

When driving single ac-coupled loads in standard 75 Ω video distribution systems, a minimum capacitance of 220 μF is recommended to avoid line and field droop. There are two ac coupling options when driving two loads from one output. One option simply uses the same value capacitor on the second load, while the other option uses a common coupling capacitor that is at least twice the value used for the single load (see Figure 20 and Figure 21).

When driving two parallel 150 Ω loads (75 Ω effective load), the 3 dB bandwidth of the filters typically varies from that of the filters with a single 150 Ω load (see Figure 4).

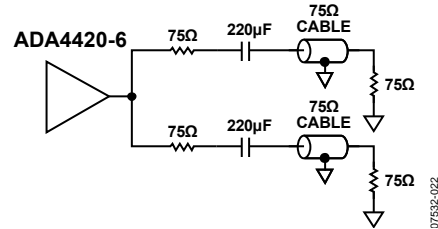

Figure 20. Driving Two AC-Coupled Loads with Two Coupling Capacitors

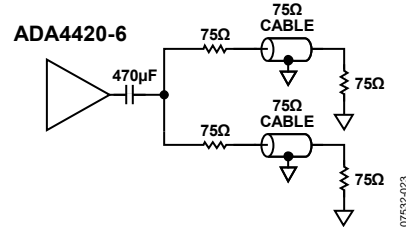

Figure 21. Driving Two AC-Coupled Loads with One Common Coupling Capacitor

PRINTED CIRCUIT BOARD (PCB) LAYOUT

As with all high speed applications, attention to the PCB layout is of paramount importance. When designing with the ADA4420-6, adhere to standard high speed layout practices. A solid ground plane is recommended, and surface-mount, ceramic power supply decoupling capacitors should be placed as close as possible to the supply pins. Connect all of the ADA4420-6 GND pins to the ground plane with traces that are as short as possible. Controlled impedance traces of the shortest length possible should be used to connect to the signal I/O pins and should not pass over any voids in the ground plane. A 75 Ω impedance level is typically used in video applications. When driving transmission lines, include series termination resistors on the signal outputs of the ADA4420-6.

When the ADA4420-6 receives its inputs from a device with current outputs, the required load resistor value for the output current is often different from the characteristic impedance of the signal traces. In this case, if the interconnections are short ($\ll 0.1$ wavelength), the trace does not have to be terminated in its characteristic impedance. Traces of 75 Ω can be used in this instance, provided their lengths are an inch or two at most. This is easily achieved because the ADA4420-6 and the device feeding it are usually adjacent to each other, and connections can be made that are less than one inch in length.

VIDEO ENCODER RECONSTRUCTION FILTER

The ADA4420-6 is easily applied as a reconstruction filter at the DAC outputs of a video encoder. Figure 22 illustrates how to use the ADA4420-6 in this type of application following an ADV734x series video encoder, with a single-supply and ac-coupled outputs.

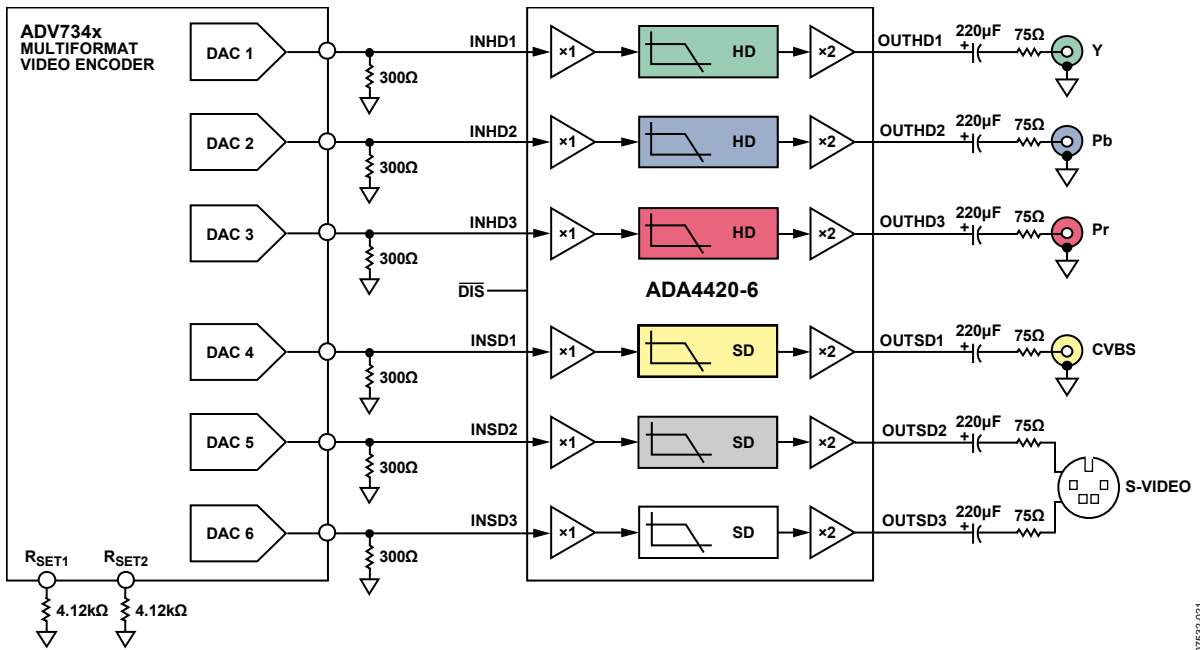
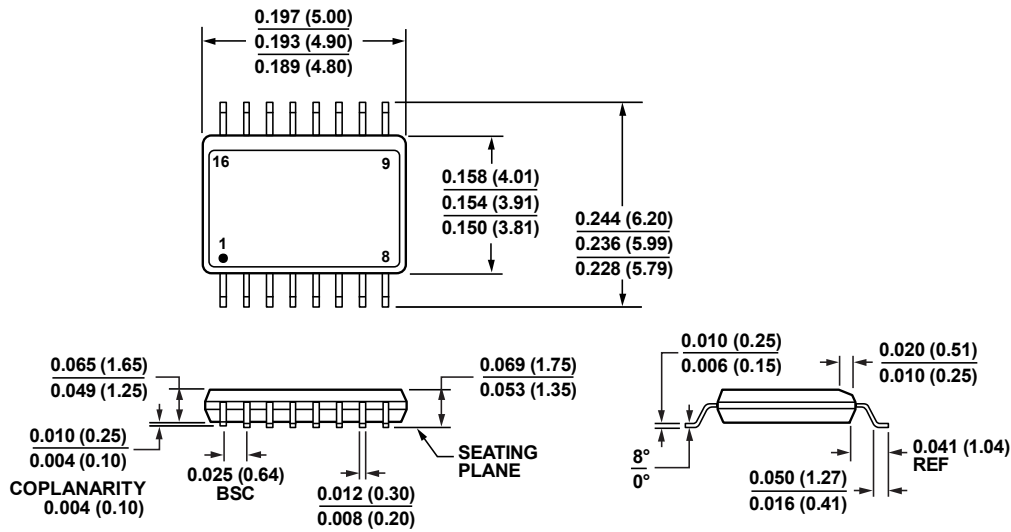

Figure 22. The ADA4420-6 Applied as a Reconstruction Filter Following an ADV734x Series Video Encoder

07532-021

OUTLINE DIMENSIONS



COMPLIANT TO JEDEC STANDARDS MO-137-AB
 CONTROLLING DIMENSIONS ARE IN INCHES; MILLIMETERS DIMENSIONS
 (IN PARENTHESES) ARE ROUNDED-OFF INCH EQUIVALENTS FOR
 REFERENCE ONLY AND ARE NOT APPROPRIATE FOR USE IN DESIGN.

Figure 23. 16-Lead Shrink Small Outline Package [QSOP]
 (RQ-16)

Dimensions shown in inches and (millimeters)

012808-A

ORDERING GUIDE

Model	Temperature Range	Package Description	Package Option	Ordering Quantity
ADA4420-6ARQZ ¹	-40°C to +85°C	16-Lead Shrink Small Outline Package (QSOP)	RQ-16	1
ADA4420-6ARQZ-R7 ¹	-40°C to +85°C	16-Lead Shrink Small Outline Package (QSOP)	RQ-16	1,000
ADA4420-6ARQZ-RL ¹	-40°C to +85°C	16-Lead Shrink Small Outline Package (QSOP)	RQ-16	1,500

¹ Z = RoHS Compliant Part.