

SA58631

3 W BTL audio amplifier

Rev. 01 — 1 December 2005

Preliminary data sheet

1. General description

The SA58631 is a one channel audio amplifier in a HVSON8 package. It provides power output of 3 W with a 8 Ω load at 9 V supply. The internal circuit is comprised of a BTL (Bridge Tied Load) amplifier with a complementary PNP-NPN output stage and standby/mute logic. The SA58631 is housed in an 8-pin HVSON package which has an exposed die attach paddle enabling reduced thermal resistance and increased power dissipation.

2. Features

- Low junction-to-ambient thermal resistance using exposed die attach paddle
- Gain can be fixed with external resistors from 6 dB to 30 dB
- Standby mode controlled by CMOS compatible levels
- Low standby current <10 μ A
- No switch-on/switch-off plops
- High power supply ripple rejection 50 dB minimum
- ElectroStatic Discharge (ESD) protection
- Output short circuit to ground protection
- Thermal shutdown protection

3. Applications

- Professional and amateur mobile radio
- Portable consumer products: toys and games
- Personal computer remote speakers

PHILIPS

4. Quick reference data

Table 1: Quick reference data

| Symbol | Parameter | Conditions | Min | Typ | Max | Unit |
|-----------|--------------------------------------|-----------------------------------|-----|------|-----|---------------|
| V_{CC} | supply voltage | | 2.2 | 9 | 18 | V |
| I_q | quiescent current | $V_{CC} = 5\text{ V}$ | - | 8 | 12 | mA |
| I_{stb} | standby current | | - | - | 10 | μA |
| P_o | output power | THD + N = 10 %; $R_L = 8\ \Omega$ | | | | |
| | | $V_{CC} = 5\text{ V}$ | 1 | 1.2 | - | W |
| | | $V_{CC} = 9\text{ V}$ | - | 3 | - | W |
| THD + N | total harmonic distortion-plus-noise | $P_o = 0.5\text{ W}$ | - | 0.15 | - | % |
| PSRR | power supply rejection ratio | | 50 | - | - | dB |

5. Ordering information

Table 2: Ordering information

| Type number | Package | | Version |
|-------------|---------|------------------------------------------------------------------------------------------------------|----------|
| | Name | Description | |
| SA58631TK | HVSON8 | plastic thermal enhanced very thin small outline package; no leads; 8 terminals; body 4 x 4 x 0.8 mm | SOT909-1 |

6. Block diagram

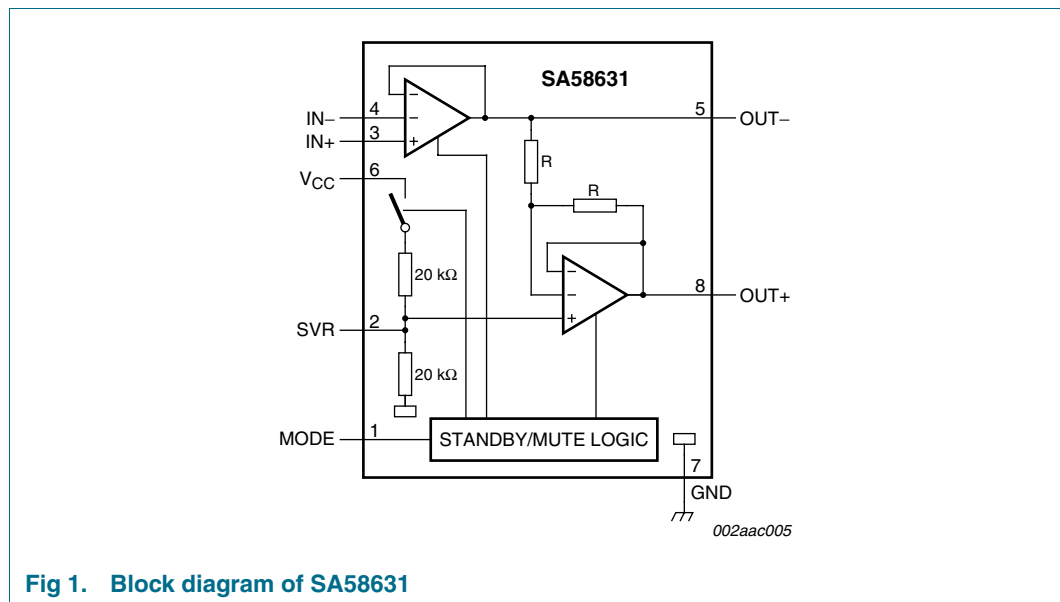

Fig 1. Block diagram of SA58631

7. Pinning information

7.1 Pinning

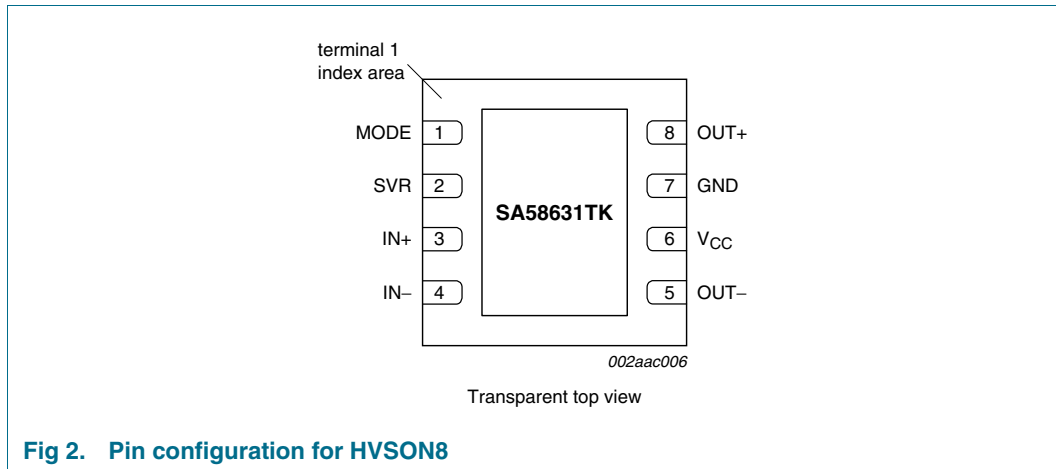

Fig 2. Pin configuration for HVSON8

7.2 Pin description

Table 3: Pin description

| Symbol | Pin | Description |
|-----------------|-----|--------------------------------------------------|
| MODE | 1 | operating mode select (standby, mute, operating) |
| SVR | 2 | half supply voltage, decoupling ripple rejection |
| IN+ | 3 | positive input |
| IN- | 4 | negative input |
| OUT- | 5 | negative output terminal |
| V _{CC} | 6 | supply voltage |
| GND | 7 | ground |
| OUT+ | 8 | positive output terminal |

8. Functional description

The SA58631 is a single channel BTL audio amplifier capable of delivering 3 W output power to an 8 Ω load at THD + N = 10 % using a 9 V power supply. Using the MODE pin, the device can be switched to standby and mute condition. The device is protected by an internal thermal shutdown protection mechanism. The gain can be set within a range of 6 dB to 30 dB by external feedback resistors.

8.1 Power amplifier

The power amplifier is a Bridge Tied Load (BTL) amplifier with a complementary PNP-NPN output stage. The voltage loss on the positive supply line is the saturation voltage of a PNP power transistor, on the negative side the saturation voltage of an NPN power transistor. The total voltage loss is < 1 V. With a supply voltage of 9 V and an 8 Ω loudspeaker, an output power of 3 W can be delivered to the load.

8.2 Mode select pin (MODE)

The device is in Standby mode (with a very low current consumption) if the voltage at the MODE pin is greater than $V_{CC} - 0.5$ V, or if this pin is floating. At a MODE voltage in the range between 1.5 V and $V_{CC} - 1.5$ V the amplifier is in a mute condition. The mute condition is useful to suppress pop noise at the output, caused by charging of the input capacitor.

9. Limiting values

Table 4: Limiting values

In accordance with the Absolute Maximum Rating System (IEC 60134).

| Symbol | Parameter | Conditions | Min | Max | Unit |
|-----------|--------------------------------------|---------------|------|----------------|------|
| V_{CC} | supply voltage | operating | -0.3 | +18 | V |
| V_I | input voltage | | -0.3 | $V_{CC} + 0.3$ | V |
| I_{ORM} | repetitive peak output current | | - | 1 | A |
| T_{stg} | storage temperature | non-operating | -55 | +150 | °C |
| T_{amb} | ambient temperature | operating | -40 | +85 | °C |
| V_{psc} | AC and DC short-circuit safe voltage | | - | 10 | V |
| P_{tot} | total power dissipation | HVSON8 | - | 2.3 | W |

10. Thermal characteristics

Table 5: Thermal characteristics

| Symbol | Parameter | Conditions | Typ | Unit |
|----------------|--------------------------------------------------|-------------------------------|--------|------|
| $R_{th(j-a)}$ | thermal resistance from junction to ambient | free air | 80 | K/W |
| | | 1.5 square inch heat spreader | [1] 32 | K/W |
| | | 5 square inch heat spreader | [1] 28 | K/W |
| $R_{th(j-sp)}$ | thermal resistance from junction to solder point | | 5 | K/W |

[1] R_{th} is 28 K/W with DAP soldered to 5 square inch, 1 ounce copper heat spreader.

11. Static characteristics

Table 6: Static characteristics
 $V_{CC} = 5\text{ V}$; $T_{amb} = 25\text{ }^{\circ}\text{C}$; $R_L = 8\text{ }\Omega$; $V_{MODE} = 0\text{ V}$; measured in test circuit [Figure 3](#); unless otherwise specified.

| Symbol | Parameter | Conditions | Min | Typ | Max | Unit |
|-------------------------|------------------------------------|----------------------------------|----------------|-----|----------------|---------------|
| V_{CC} | supply voltage | operating | 2.2 | 9 | 18 | V |
| I_q | quiescent current | $R_L = \infty$ | [1] - | 8 | 12 | mA |
| I_{stb} | standby current | $V_{MODE} = V_{CC}$ | - | - | 10 | μA |
| V_O | output voltage | | [2] - | 2.2 | - | V |
| $ V_{OUT+} - V_{OUT-} $ | differential output voltage offset | | - | - | 50 | mV |
| $I_{IB(IN+)}$ | input bias current on pin IN+ | | - | - | 500 | nA |
| $I_{IB(IN-)}$ | input bias current on pin IN- | | - | - | 500 | nA |
| V_{MODE} | voltage on pin MODE | operating | 0 | - | 0.5 | V |
| | | mute | 1.5 | - | $V_{CC} - 1.5$ | V |
| | | standby | $V_{CC} - 0.5$ | - | V_{CC} | V |
| I_{MODE} | current on pin MODE | $0\text{ V} < V_{MODE} < V_{CC}$ | - | - | 20 | μA |

[1] With a load connected at the outputs the quiescent current will increase, the maximum of this increase being equal to the DC output offset voltage divided by R_L .

[2] The DC output voltage with respect to ground is approximately $0.5 \times V_{CC}$.

12. Dynamic characteristics

Table 7: Dynamic characteristics
 $V_{CC} = 5\text{ V}$; $T_{amb} = 25\text{ }^{\circ}\text{C}$; $R_L = 8\text{ }\Omega$; $f = 1\text{ kHz}$; $V_{MODE} = 0\text{ V}$; measured in test circuit [Figure 3](#); unless otherwise specified.

| Symbol | Parameter | Conditions | Min | Typ | Max | Unit |
|--------------|--------------------------------------|---------------------------------------|--------|------|-----|---------------|
| P_o | output power | THD + N = 10 % | 1 | 1.2 | - | W |
| | | THD + N = 0.5 % | 0.6 | 0.9 | - | W |
| | | THD + N = 10 %; $V_{CC} = 9\text{ V}$ | - | 3.0 | - | W |
| THD + N | total harmonic distortion plus noise | $P_o = 0.5\text{ W}$ | - | 0.15 | 0.3 | % |
| $G_{V(cl)}$ | closed-loop voltage gain | | [1] 6 | - | 30 | dB |
| ΔZ_i | differential input impedance | | - | 100 | - | k Ω |
| $V_{n(o)}$ | noise output voltage | | [2] - | - | 100 | μV |
| PSRR | power supply rejection ratio | | [3] 50 | - | - | dB |
| | | | [4] 40 | - | - | dB |
| V_O | output voltage | mute condition | [5] - | - | 200 | μV |

[1] Gain of the amplifier is $2 \times (R_2 / R_1)$ in test circuit of [Figure 3](#).

[2] The noise output voltage is measured at the output in a frequency range from 20 Hz to 20 kHz (unweighted), with a source impedance of $R_s = 0\text{ }\Omega$ at the input.

[3] Supply voltage ripple rejection is measured at the output with a source impedance of $R_s = 0\text{ }\Omega$ at the input. The ripple voltage is a sine wave with a frequency of 1 kHz and an amplitude of 100 mV (RMS), which is applied to the positive supply rail.

[4] Supply voltage ripple rejection is measured at the output, with a source impedance of $R_s = 0\text{ }\Omega$ at the input. The ripple voltage is a sine wave with a frequency between 100 Hz and 20 kHz and an amplitude of 100 mV (RMS), which is applied to the positive supply rail.

[5] Output voltage in mute position is measured with an input voltage of 1 V (RMS) in a bandwidth of 20 kHz, which includes noise.

13. Application information

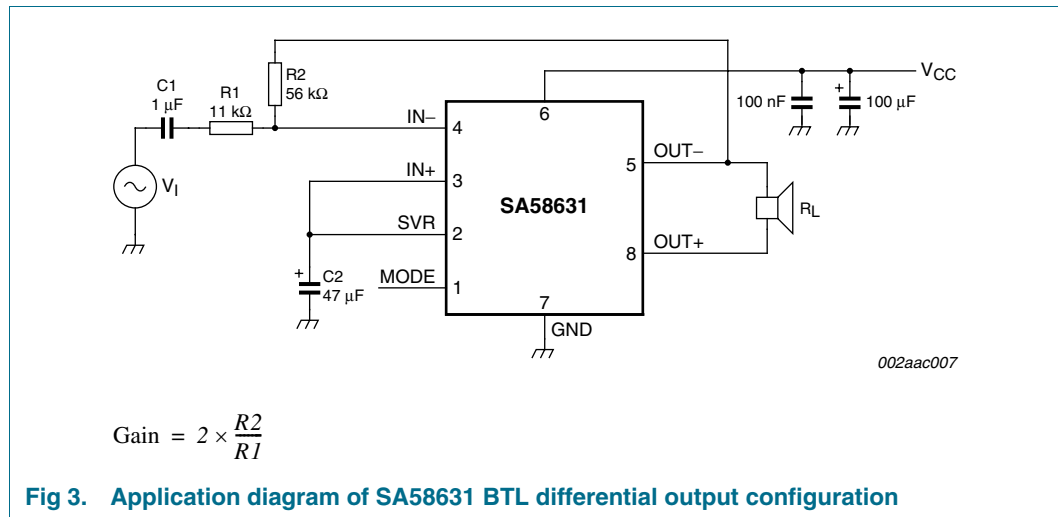

14. Test information

14.1 Test conditions

The junction to ambient thermal resistance, $R_{th(j-a)} = 27.7$ K/W for the HVSON8 package when the exposed die attach paddle is soldered to 5 square inch area of 1 ounce copper heat spreader on the demo PCB. The maximum sine wave power dissipation for $T_{amb} = 25$ °C is:

$$\frac{150 - 25}{27.7} = 4.5 \text{ W.}$$

Thus, for $T_{amb} = +85$ °C the maximum total power dissipation is:

$$\frac{150 - 85}{27.7} = 2.35 \text{ W.}$$

The power dissipation versus ambient temperature curve ([Figure 5](#)) shows the power derating profiles with ambient temperature for three sizes of heat spreaders. For a more modest heat spreader using 1.5 square inch area on the top side of the PCB, the $R_{th(j-a)}$ is 31.25 K/W. When the package is not soldered to a heat spreader, the $R_{th(j-a)}$ increases to 83.3 K/W.

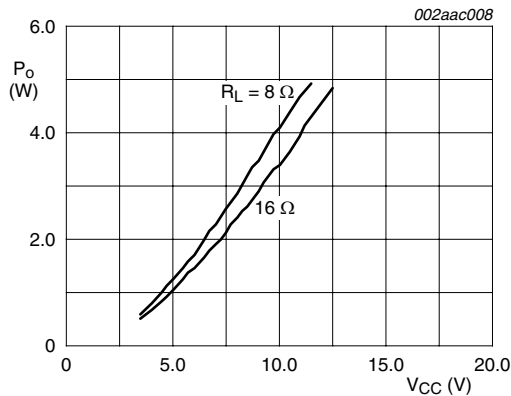
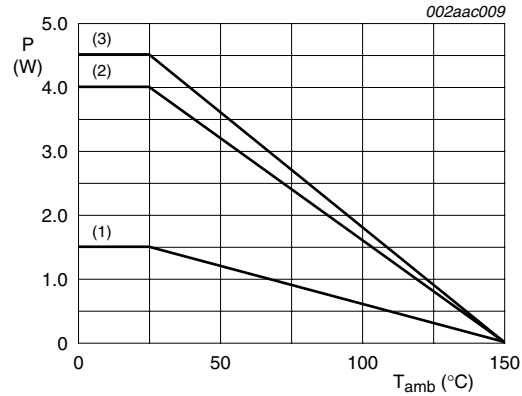

Fig 4. Output power versus supply voltage @ THD + N = 10 %; 5 in² heat spreader



- (1) No heat spreader.
- (2) Top only heat spreader (1.5 in², 1 ounce copper).
- (3) Both top and bottom heat spreader (approximately 5 in², 1 ounce copper).

Fig 5. Power dissipation versus ambient temperature

14.2 BTL application

$T_{amb} = 25\text{ }^{\circ}\text{C}$, $V_{CC} = 9\text{ V}$, $f = 1\text{ kHz}$, $R_L = 8\text{ }\Omega$, $G_v = 20\text{ dB}$, audio band-pass 20 Hz to 20 kHz. The BTL diagram is shown in [Figure 3](#).

The quiescent current has been measured without any load impedance. The total harmonic distortion + noise (THD + N) as a function of frequency was measured with a low-pass filter of 80 kHz. The value of capacitor C2 influences the behavior of PSRR at low frequencies; increasing the value of C2 increases the performance of PSRR. [Figure 6](#) "[V_{MODE} versus V_{CC}](#)" shows three areas: operating, mute and standby. It shows that the DC switching levels of the mute and standby respectively depends on the supply voltage level.

The following characterization curves show the room temperature performance for SA58631 using the demo PCB shown in [Figure 21](#). The 8 curves for power dissipation versus output power ([Figure 10](#) through [Figure 17](#)) as a function of supply voltage, heat spreader area, load resistance and voltage gain show that there is very little difference in performance with voltage gain; however, there are significant differences with supply voltage and load resistance.

The curves for THD + N versus output power ([Figure 18](#)) show that the SA58631 yields the best power output using an 8 Ω load at 9 V supply. Under these conditions the part delivers typically 3 W output power for THD + N = 10 %.

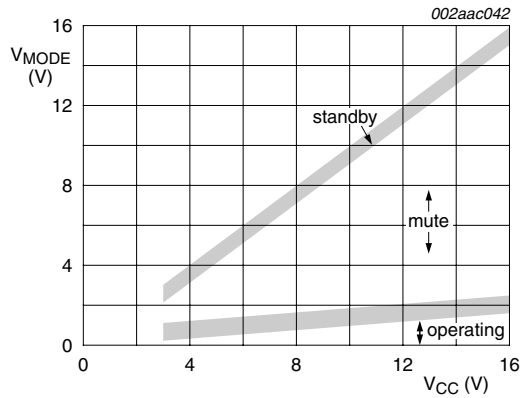

Fig 6. V_{MODE} versus V_{CC}

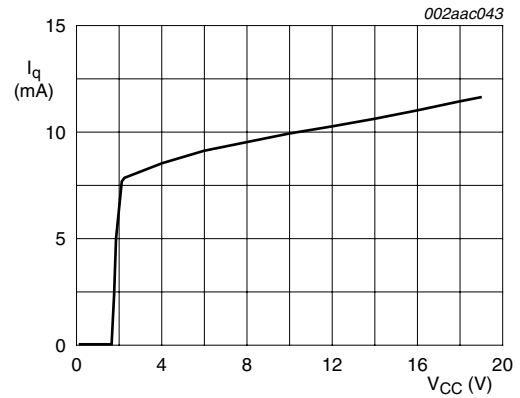
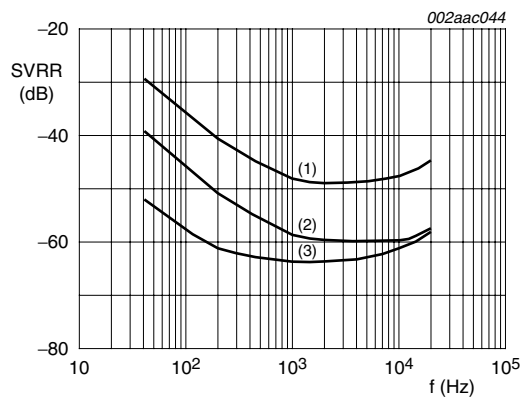

Fig 7. I_q versus V_{CC}



$V_{CC} = 5$ V, $R_L = 8 \Omega$; $R_s = 0 \Omega$; $V_I = 100$ mV.

- (1) $G_v = 30$ dB
- (2) $G_v = 20$ dB
- (3) $G_v = 6$ dB

Fig 8. SVRR versus frequency

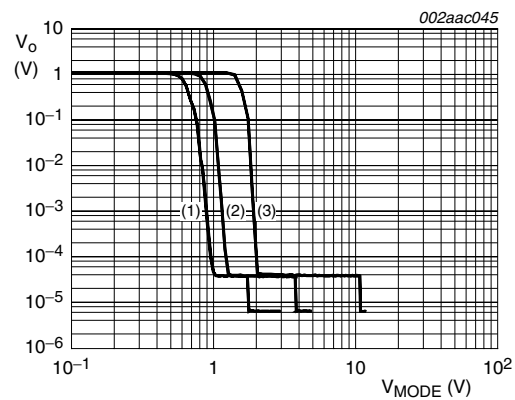

Band-pass = 22 Hz to 22 kHz.

- (1) $V_{CC} = 3$ V
- (2) $V_{CC} = 5$ V
- (3) $V_{CC} = 12$ V

Fig 9. V_o versus V_{MODE}

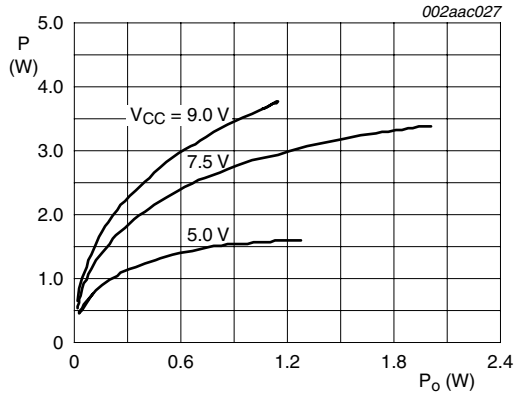

Fig 10. Power dissipation versus output power; $R_L = 4.0 \Omega$; $G_V = 10 \text{ dB}$; 1.5 inch^2 heat spreader

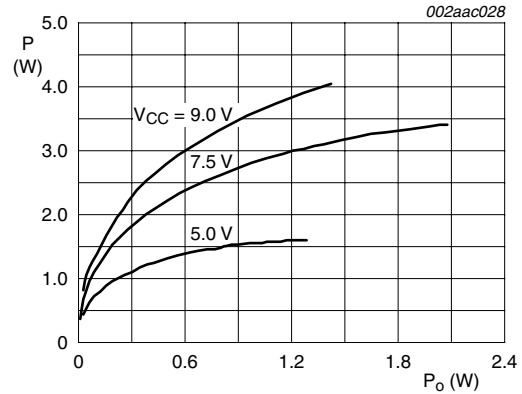

Fig 11. Power dissipation versus output power; $R_L = 4.0 \Omega$; $G_V = 20 \text{ dB}$; 1.5 inch^2 heat spreader

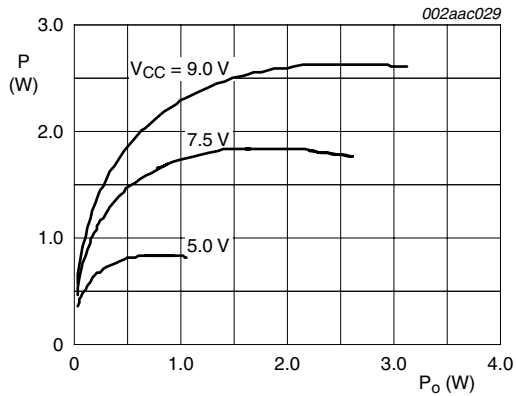

Fig 12. Power dissipation versus output power; $R_L = 8.0 \Omega$; $G_V = 10 \text{ dB}$; 1.5 inch^2 heat spreader

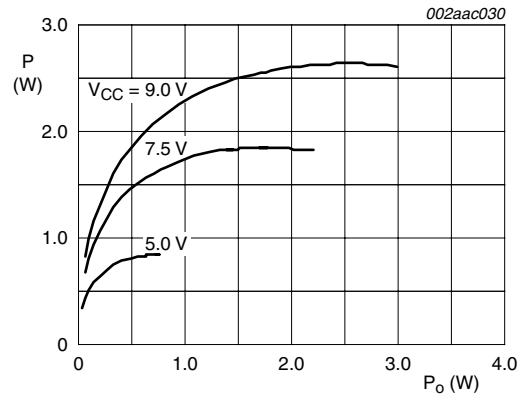

Fig 13. Power dissipation versus output power; $R_L = 8.0 \Omega$; $G_V = 20 \text{ dB}$; 1.5 inch^2 heat spreader

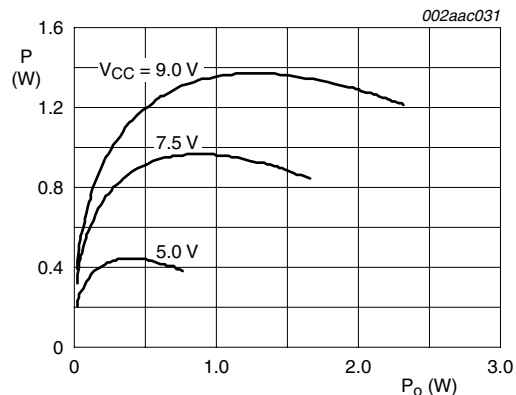

Fig 14. Power dissipation versus output power; $R_L = 16 \Omega$; $G_V = 10 \text{ dB}$; 1.5 inch^2 heat spreader

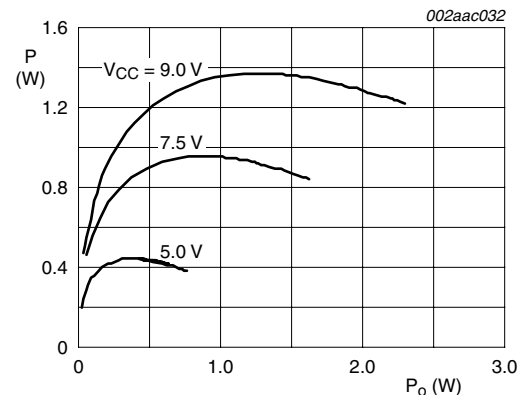

Fig 15. Power dissipation versus output power; $R_L = 16 \Omega$; $G_V = 20 \text{ dB}$; 1.5 inch^2 heat spreader

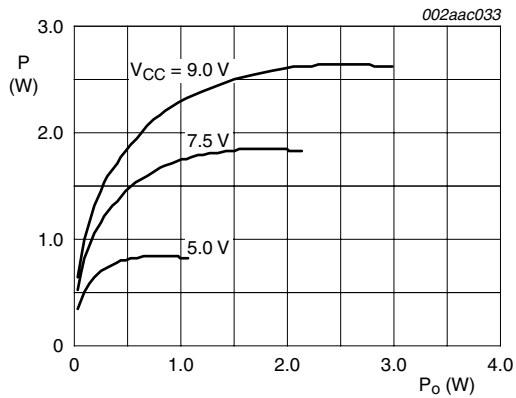

Fig 16. Power dissipation versus output power; $R_L = 8.0 \Omega$; $G_V = 20 \text{ dB}$; 5 inch² heat spreader

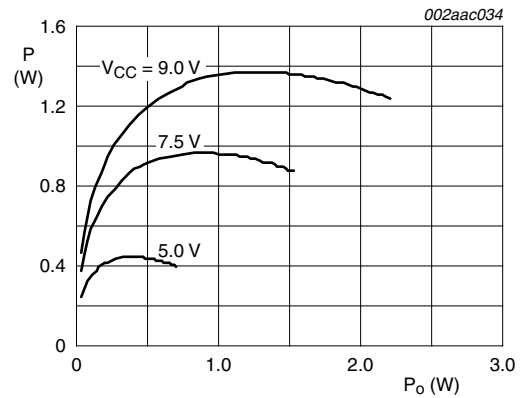
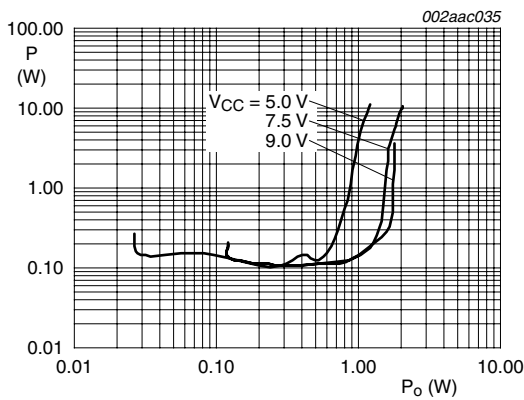
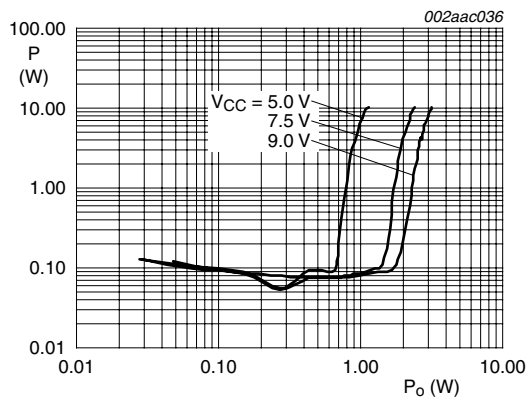

Fig 17. Power dissipation versus output power; $R_L = 16 \Omega$; $G_V = 20 \text{ dB}$; 5 inch² heat spreader



a. $f = 1 \text{ kHz}$; $R_L = 4 \Omega$



b. $f = 1 \text{ kHz}$; $R_L = 8 \Omega$

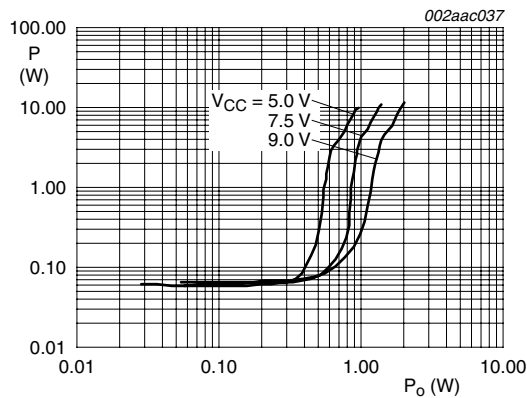

c. $f = 1 \text{ kHz}$; $R_L = 16 \Omega$

Fig 18. THD + N versus output power

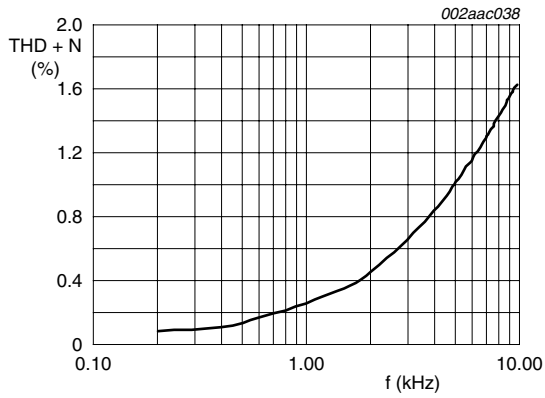

a. $R_L = 4 \Omega$

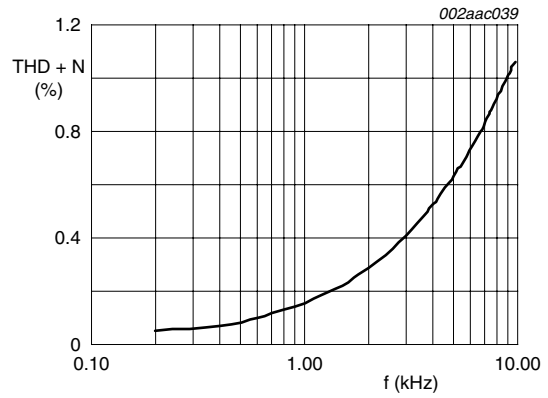

b. $R_L = 8 \Omega$

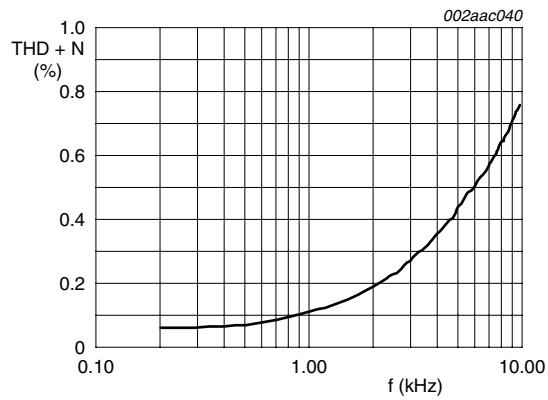

c. $R_L = 16 \Omega$

Fig 19. THD + N versus frequency

14.3 Single-ended application

$T_{amb} = 25\text{ }^{\circ}\text{C}$; $V_{CC} = 7.5\text{ V}$; $f = 1\text{ kHz}$; $R_L = 8\text{ }\Omega$; $G_v = 20\text{ dB}$; audio band-pass 20 Hz to 20 kHz.

The Single-Ended (SE) application diagram is shown in [Figure 20](#).

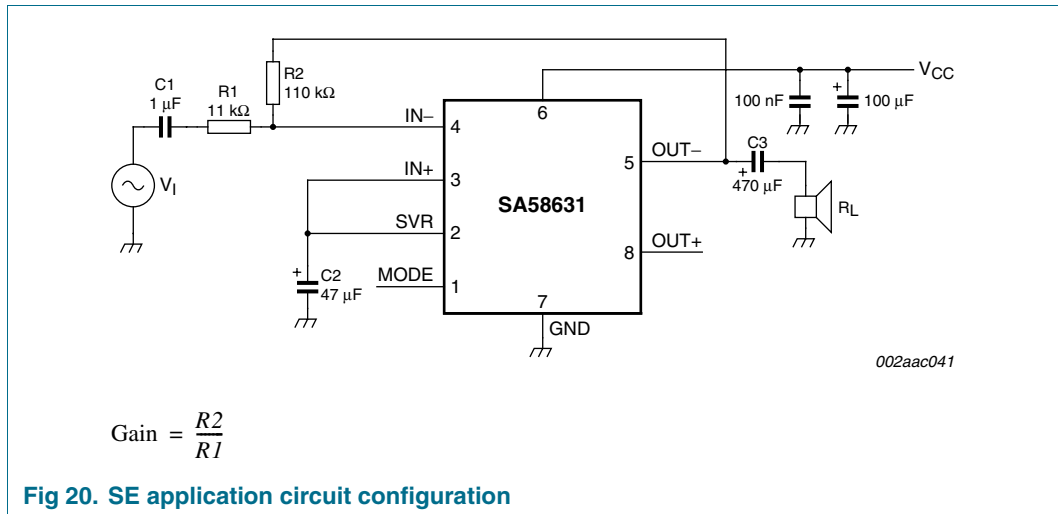

The capacitor value of C3 in combination with the load impedance determines the low frequency behavior. The total harmonic distortion + noise as a function of frequency was measured with a low-pass filter of 80 kHz. The value of the capacitor C2 influences the behavior of the PSRR at low frequencies; increasing the value of C2 increases the performance of PSRR.

14.4 General remarks

The frequency characteristics can be adapted by connecting a small capacitor across the feedback resistor. To improve the immunity of HF radiation in radio circuit applications, a small capacitor can be connected in parallel with the feedback resistor (56 kΩ); this creates a low-pass filter.

14.5 SA58631TK PCB demo

The application demo board may be used for evaluation in either BTL or SE configuration as shown in the schematics in [Figure 3](#) and [Figure 20](#). The demo PCB is laid out for the 5 square inch heat spreader (total of top and bottom heat spreader area).

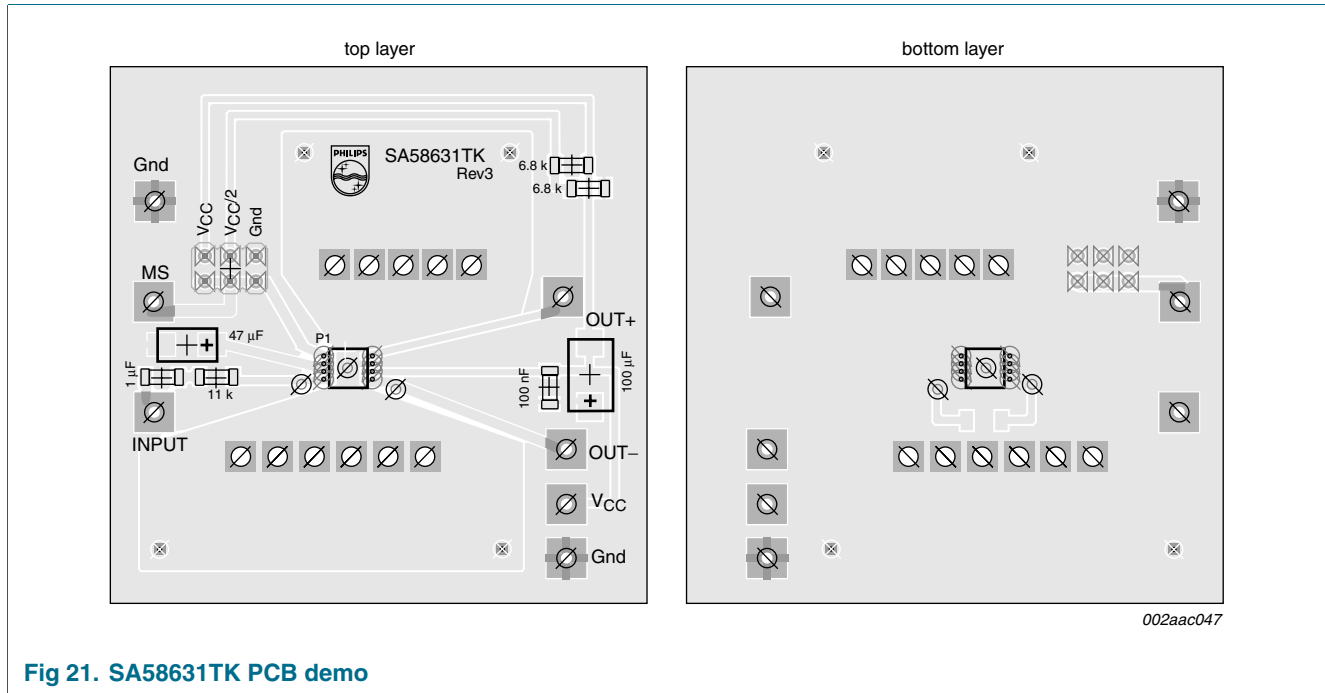

Fig 21. SA58631TK PCB demo

15. Package outline

HVSON8: plastic thermal enhanced very thin small outline package; no leads; 8 terminals; body 4 x 4 x 0.85 mm

SOT909-1

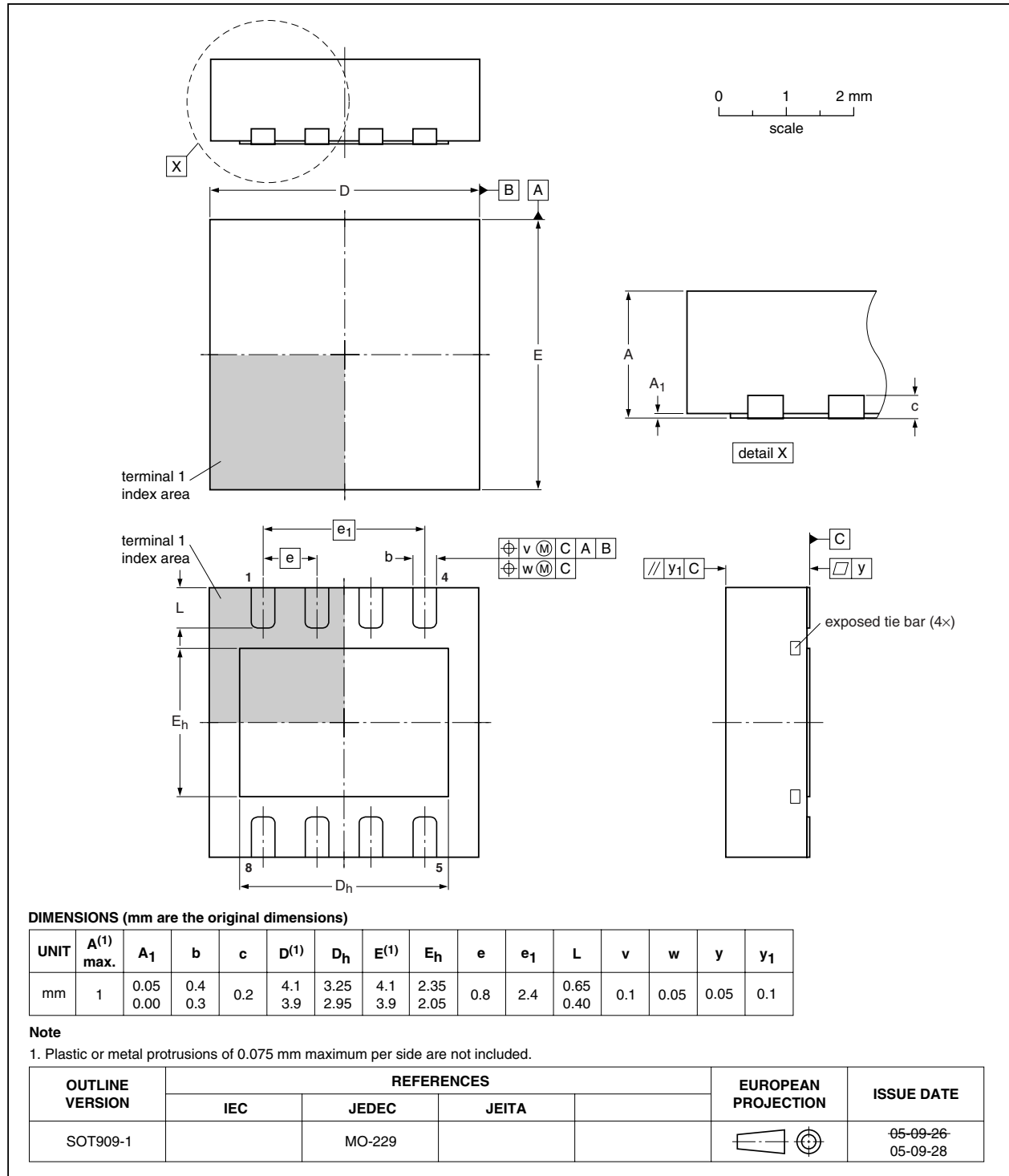

Fig 22. Package outline SOT909-1 (HVSON8)

16. Soldering

16.1 Introduction to soldering surface mount packages

This text gives a very brief insight to a complex technology. A more in-depth account of soldering ICs can be found in our *Data Handbook IC26; Integrated Circuit Packages* (document order number 9398 652 90011).

There is no soldering method that is ideal for all surface mount IC packages. Wave soldering can still be used for certain surface mount ICs, but it is not suitable for fine pitch SMDs. In these situations reflow soldering is recommended.

16.2 Reflow soldering

Reflow soldering requires solder paste (a suspension of fine solder particles, flux and binding agent) to be applied to the printed-circuit board by screen printing, stencilling or pressure-syringe dispensing before package placement. Driven by legislation and environmental forces the worldwide use of lead-free solder pastes is increasing.

Several methods exist for reflowing; for example, convection or convection/infrared heating in a conveyor type oven. Throughput times (preheating, soldering and cooling) vary between 100 seconds and 200 seconds depending on heating method.

Typical reflow peak temperatures range from 215 °C to 270 °C depending on solder paste material. The top-surface temperature of the packages should preferably be kept:

- below 225 °C (SnPb process) or below 245 °C (Pb-free process)
 - for all BGA, HTSSON..T and SSOP..T packages
 - for packages with a thickness ≥ 2.5 mm
 - for packages with a thickness < 2.5 mm and a volume ≥ 350 mm³ so called thick/large packages.
- below 240 °C (SnPb process) or below 260 °C (Pb-free process) for packages with a thickness < 2.5 mm and a volume < 350 mm³ so called small/thin packages.

Moisture sensitivity precautions, as indicated on packing, must be respected at all times.

16.3 Wave soldering

Conventional single wave soldering is not recommended for surface mount devices (SMDs) or printed-circuit boards with a high component density, as solder bridging and non-wetting can present major problems.

To overcome these problems the double-wave soldering method was specifically developed.

If wave soldering is used the following conditions must be observed for optimal results:

- Use a double-wave soldering method comprising a turbulent wave with high upward pressure followed by a smooth laminar wave.
- For packages with leads on two sides and a pitch (e):
 - larger than or equal to 1.27 mm, the footprint longitudinal axis is **preferred** to be parallel to the transport direction of the printed-circuit board;

- smaller than 1.27 mm, the footprint longitudinal axis **must** be parallel to the transport direction of the printed-circuit board.

The footprint must incorporate solder thieves at the downstream end.

- For packages with leads on four sides, the footprint must be placed at a 45° angle to the transport direction of the printed-circuit board. The footprint must incorporate solder thieves downstream and at the side corners.

During placement and before soldering, the package must be fixed with a droplet of adhesive. The adhesive can be applied by screen printing, pin transfer or syringe dispensing. The package can be soldered after the adhesive is cured.

Typical dwell time of the leads in the wave ranges from 3 seconds to 4 seconds at 250 °C or 265 °C, depending on solder material applied, SnPb or Pb-free respectively.

A mildly-activated flux will eliminate the need for removal of corrosive residues in most applications.

16.4 Manual soldering

Fix the component by first soldering two diagonally-opposite end leads. Use a low voltage (24 V or less) soldering iron applied to the flat part of the lead. Contact time must be limited to 10 seconds at up to 300 °C.

When using a dedicated tool, all other leads can be soldered in one operation within 2 seconds to 5 seconds between 270 °C and 320 °C.

16.5 Package related soldering information

Table 8: Suitability of surface mount IC packages for wave and reflow soldering methods

| Package ^[1] | Soldering method | |
|------------------------------------------------------------------------------------------------|-----------------------------------------------|-----------------------|
| | Wave | Reflow ^[2] |
| BGA, HTSSON..T ^[3] , LBGA, LFBGA, SQFP, SSOP..T ^[3] , TFBGA, VFBGA, XSON | not suitable | suitable |
| DHVQFN, HBCC, HBGA, HLQFP, HSO, HSOP, HSQFP, HSSON, HTQFP, HTSSOP, HVQFN, HVSON, SMS | not suitable ^[4] | suitable |
| PLCC ^[5] , SO, SOJ | suitable | suitable |
| LQFP, QFP, TQFP | not recommended ^[5] ^[6] | suitable |
| SSOP, TSSOP, VSO, VSSOP | not recommended ^[7] | suitable |
| CWQCCN..L ^[8] , PMFP ^[9] , WQCCN..L ^[8] | not suitable | not suitable |

[1] For more detailed information on the BGA packages refer to the *(LF)BGA Application Note (AN01026)*; order a copy from your Philips Semiconductors sales office.

[2] All surface mount (SMD) packages are moisture sensitive. Depending upon the moisture content, the maximum temperature (with respect to time) and body size of the package, there is a risk that internal or external package cracks may occur due to vaporization of the moisture in them (the so called popcorn effect). For details, refer to the Drypack information in the *Data Handbook IC26; Integrated Circuit Packages; Section: Packing Methods*.

[3] These transparent plastic packages are extremely sensitive to reflow soldering conditions and must on no account be processed through more than one soldering cycle or subjected to infrared reflow soldering with peak temperature exceeding 217 °C ± 10 °C measured in the atmosphere of the reflow oven. The package body peak temperature must be kept as low as possible.

- [4] These packages are not suitable for wave soldering. On versions with the heatsink on the bottom side, the solder cannot penetrate between the printed-circuit board and the heatsink. On versions with the heatsink on the top side, the solder might be deposited on the heatsink surface.
- [5] If wave soldering is considered, then the package must be placed at a 45° angle to the solder wave direction. The package footprint must incorporate solder thieves downstream and at the side corners.
- [6] Wave soldering is suitable for LQFP, QFP and TQFP packages with a pitch (e) larger than 0.8 mm; it is definitely not suitable for packages with a pitch (e) equal to or smaller than 0.65 mm.
- [7] Wave soldering is suitable for SSOP, TSSOP, VSO and VSSOP packages with a pitch (e) equal to or larger than 0.65 mm; it is definitely not suitable for packages with a pitch (e) equal to or smaller than 0.5 mm.
- [8] Image sensor packages in principle should not be soldered. They are mounted in sockets or delivered pre-mounted on flex foil. However, the image sensor package can be mounted by the client on a flex foil by using a hot bar soldering process. The appropriate soldering profile can be provided on request.
- [9] Hot bar soldering or manual soldering is suitable for PMFP packages.

17. Abbreviations

Table 9: Abbreviations

| Acronym | Description |
|---------|-----------------------------------|
| BTL | Bridge Tied Load |
| CMOS | Complementary Metal Oxide Silicon |
| DAP | Die Attach Paddle |
| ESD | ElectroStatic Discharge |
| NPN | Negative-Positive-Negative |
| PCB | Printed-Circuit Board |
| PNP | Positive-Negative-Positive |
| RMS | Root Mean Squared |
| THD | Total Harmonic Distortion |

18. Revision history

Table 10: Revision history

| Document ID | Release date | Data sheet status | Change notice | Doc. number | Supersedes |
|-------------|--------------|------------------------|---------------|-------------|------------|
| SA58631_1 | 20051201 | Preliminary data sheet | - | SA58631_1 | - |

19. Data sheet status

| Level | Data sheet status ^[1] | Product status ^{[2] [3]} | Definition |
|-------|----------------------------------|-----------------------------------|------------------------------------------------------------------------------------------------------------------------------------------------------------------------------------------------------------------------------------------------------------------------------------------------|
| I | Objective data | Development | This data sheet contains data from the objective specification for product development. Philips Semiconductors reserves the right to change the specification in any manner without notice. |
| II | Preliminary data | Qualification | This data sheet contains data from the preliminary specification. Supplementary data will be published at a later date. Philips Semiconductors reserves the right to change the specification without notice, in order to improve the design and supply the best possible product. |
| III | Product data | Production | This data sheet contains data from the product specification. Philips Semiconductors reserves the right to make changes at any time in order to improve the design, manufacturing and supply. Relevant changes will be communicated via a Customer Product/Process Change Notification (CPCN). |

[1] Please consult the most recently issued data sheet before initiating or completing a design.

[2] The product status of the device(s) described in this data sheet may have changed since this data sheet was published. The latest information is available on the Internet at URL <http://www.semiconductors.philips.com>.

[3] For data sheets describing multiple type numbers, the highest-level product status determines the data sheet status.

20. Definitions

Short-form specification — The data in a short-form specification is extracted from a full data sheet with the same type number and title. For detailed information see the relevant data sheet or data handbook.

Limiting values definition — Limiting values given are in accordance with the Absolute Maximum Rating System (IEC 60134). Stress above one or more of the limiting values may cause permanent damage to the device. These are stress ratings only and operation of the device at these or at any other conditions above those given in the Characteristics sections of the specification is not implied. Exposure to limiting values for extended periods may affect device reliability.

Application information — Applications that are described herein for any of these products are for illustrative purposes only. Philips Semiconductors make no representation or warranty that such applications will be suitable for the specified use without further testing or modification.

customers using or selling these products for use in such applications do so at their own risk and agree to fully indemnify Philips Semiconductors for any damages resulting from such application.

Right to make changes — Philips Semiconductors reserves the right to make changes in the products - including circuits, standard cells, and/or software - described or contained herein in order to improve design and/or performance. When the product is in full production (status 'Production'), relevant changes will be communicated via a Customer Product/Process Change Notification (CPCN). Philips Semiconductors assumes no responsibility or liability for the use of any of these products, conveys no license or title under any patent, copyright, or mask work right to these products, and makes no representations or warranties that these products are free from patent, copyright, or mask work right infringement, unless otherwise specified.

22. Trademarks

Notice — All referenced brands, product names, service names and trademarks are the property of their respective owners.

21. Disclaimers

Life support — These products are not designed for use in life support appliances, devices, or systems where malfunction of these products can reasonably be expected to result in personal injury. Philips Semiconductors

23. Contact information

For additional information, please visit: <http://www.semiconductors.philips.com>

For sales office addresses, send an email to: sales.addresses@www.semiconductors.philips.com

24. Contents

| | | |
|-----------|---------------------------------------------------------------|-----------|
| 1 | General description | 1 |
| 2 | Features | 1 |
| 3 | Applications | 1 |
| 4 | Quick reference data | 2 |
| 5 | Ordering information | 2 |
| 6 | Block diagram | 2 |
| 7 | Pinning information | 3 |
| 7.1 | Pinning | 3 |
| 7.2 | Pin description | 3 |
| 8 | Functional description | 3 |
| 8.1 | Power amplifier | 3 |
| 8.2 | Mode select pin (MODE) | 4 |
| 9 | Limiting values | 4 |
| 10 | Thermal characteristics | 4 |
| 11 | Static characteristics | 5 |
| 12 | Dynamic characteristics | 5 |
| 13 | Application information | 6 |
| 14 | Test information | 6 |
| 14.1 | Test conditions | 6 |
| 14.2 | BTL application | 7 |
| 14.3 | Single-ended application | 12 |
| 14.4 | General remarks | 12 |
| 14.5 | SA58631TK PCB demo | 13 |
| 15 | Package outline | 14 |
| 16 | Soldering | 15 |
| 16.1 | Introduction to soldering surface mount packages | 15 |
| 16.2 | Reflow soldering | 15 |
| 16.3 | Wave soldering | 15 |
| 16.4 | Manual soldering | 16 |
| 16.5 | Package related soldering information | 16 |
| 17 | Abbreviations | 17 |
| 18 | Revision history | 17 |
| 19 | Data sheet status | 18 |
| 20 | Definitions | 18 |
| 21 | Disclaimers | 18 |
| 22 | Trademarks | 18 |
| 23 | Contact information | 18 |



© Koninklijke Philips Electronics N.V. 2005

All rights are reserved. Reproduction in whole or in part is prohibited without the prior written consent of the copyright owner. The information presented in this document does not form part of any quotation or contract, is believed to be accurate and reliable and may be changed without notice. No liability will be accepted by the publisher for any consequence of its use. Publication thereof does not convey nor imply any license under patent- or other industrial or intellectual property rights.

Date of release: 1 December 2005
Document number: SA58631

Published in The Netherlands