



	ITC117P	Units
Relay Load Voltage	350	V
Relay Load Current	120	mA
Relay Max R _{ON}	15	Ω
Bridge Rectifier Reverse Voltage	100	V
Darlington Collector Current	120	mA
Darlington Current Gain	10,000	-

Description

The Integrated Telecom Circuit combines a 1-Form-A solid state relay, bridge rectifier, Darlington transistor and opto-coupler into one 16 pin SOIC package, consolidating designs and reducing component count in telecom applications. The ITC117's optocoupler provides for full wave detection of ring signals.

Features

- Small 16 Pin SOIC Package (PCMCIA Compatible)
- Board Space and Cost Savings
- 2mW Hookswitch Drive Power (Logic Compatible)
- No Moving Parts
- 3750V_{RMS} Input/Output Isolation
- FCC Compatible Part 68
- Full-Wave Bridge Rectifier
- Darlington Transistor for Electronic Inductor "Dry" Circuits
- Full Wave Current Detector for Ring Signal or Loop Current Detect
- JEDEC Standard Pin Out

Approvals

- UL Recognized: File Number E76270
- CSA Certified: File Number LR 43639-12
- BSI Certified:
 - BS EN 60950:1992 (BS7002:1992) Certificate #: 7969
 - BS EN 41003:1993 Certificate #: 7969

Ordering Information

Part #	Description
ITC117P	16 Pin SOIC (50/Tube)
ITC117P	16 Pin SOIC (1000/Reel)

Applications

- Data/Fax Modem
- Voice Mail Systems
- Telephone Sets
- Computer Telephony Integration
- Set Top Box Modems

Pin Configuration

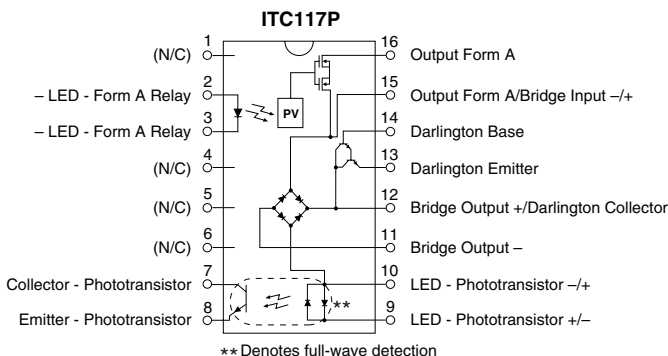

Absolute Maximum Ratings (@ 25° C)

Parameter	Min	Typ	Max	Units
Total Package Dissipation	-	-	1 ¹	W
Isolation Voltage				
Input to Output	3750	-	-	V _{RMS}
Operational Temperature	-40	-	+85	°C
Storage Temperature	-40	-	+125	°C
Soldering Temperature (10 Seconds Max.)	-	-	+220	°C

¹ Above 25° derate linearly 8.33mw/°C

Total Power Dissipation (PD):

$$P_D = P_{\text{HOOKSWITCH}} + P_{\text{BRIDGE}} + P_{\text{DARLINGTON}} + P_{\text{LED}}$$

$$P_D = (R_{DS(on)})(I_L^2) + 2(V_F)(I_L) + (V_{CE})(I_L) + (V_{LED})(I_F)$$

WHERE:

$R_{DS(on)}$ = Maximum realy on resistance

I_L = Maximum loop current

V_F = Maximum diode forward voltage

V_{CE} = Maximum voltage collector to emitter

V_{LED} = Maximum LED forward voltage

I_F = Maximum LED current

Absolute Maximum Ratings are stress ratings. Stresses in excess of these ratings can cause permanent damage to the device. Functional operation of the device at these or any other conditions beyond those indicated in the operational sections of this data sheet is not implied. Exposure of the device to the absolute maximum ratings for an extended period may degrade the device and effect its reliability.

Electrical Characteristics

Parameter	Conditions	Symbol	Min	Typ	Max	Units
Relay Portion (Pins 15,16)						
Output Characteristics @ 25°C						
Load Voltage, DC or Peak AC	-	V_L	-	-	350	V
Load Current (Continuous)	-	I_L	-	-	120	mA
On-Resistance	$I_L=120\text{mA}$	R_{ON}	-	-	15	Ω
Off-State Leakage Current	$V_L=350, T_J=25^\circ\text{C}$	I_{LEAK}	-	-	1	μA
Switching Speeds						
Turn-On	$I_F=5\text{mA}, V_L=10\text{V}$	T_{ON}	-	-	3	ms
Turn-Off	$I_F=5\text{mA}, V_L=10\text{V}$	T_{OFF}	-	-	3	ms
Output Capacitance	50V, f=1MHz	C_{OUT}	-	25	-	pF
Relay Portion (Pins 2,3)						
Input Characteristics @ 25°C						
Input Control Current	$I_L=120\text{mA}$	I_F	5	-	50	mA
Input Voltage Drop	$I_F=5\text{mA}$	V_F	0.9	1.2	1.4	V
Reverse Input Voltage	-	V_R	-	-	5	V
Reverse Input Current	$V_R=5\text{V}$	I_R	-	-	10	μA
Detector Portion (Pins 7,8)						
Output Characteristics @ 25°C						
Phototransistor Blocking Voltage	$I_C=10\mu\text{A}$	BV_{CEO}	20	50	-	V
Phototransistor Dark Current	$V_{CE}=5\text{V}, I_F=0\text{mA}$	I_{CEO}	-	50	500	A
Saturation Voltage	$I_C=2\text{mA}, I_F=16\text{mA}$	V_{SAT}	-	0.3	0.5	V
Current Transfer Ratio	$I_F=6\text{mA}, V_{CE}=0.5\text{V}$	CTR	33	400	-	%
Detector Portion (Pins 9,10)						
Input Characteristics @ 25°C						
Input Control Current	$I_C=2\text{mA}, V_{CE}=0.5\text{V}$	I_F	6	2	100	mA
Input Voltage Drop	$I_F=5\text{mA}$	V_F	0.9	1.2	1.4	V
Input Current (Detector must be off)	$I_C=1\mu\text{A}, V_{CE}=5\text{V}$	I_F	5	25	-	μA

Electrical Characteristics

Parameter	Conditions	Symbol	Min	Typ	Max	Units
Bridge Rectifier Electrical Ratings @ 25°C						
Reverse Voltage	-	V_{RD}	-	-	100	V
Forward Drop Voltage	$I_{FD}=120\text{mA}$	V_{FD}	-	-	1.5	V
Reverse Leakage Current	$T_J=25^\circ\text{C}, V_R=100\text{V}$ $T_J=85^\circ\text{C}$	I_{RD}	-	-	10	μA
Forward Current (Continuous)		I_{FD}	-	-	140	mA
Forward Current (Peak)	$t=10\text{mS}$	I_{FD}	-	-	0.5	A
Darlington Electrical Ratings @ 25°C						
Collector-Emitter Voltage	$I_C=10\text{mA DC}, I_B=0$	V_{CE0}	40	-	-	V
Collector-Current Continuous	$V_C=3.5\text{V}$	I_C	-	-	120	mA
Power Dissipation @ 25°C	-	P_d	-	-	500	mW
Off-State Collector Emitter Leakage Current	$V_{CE}=10\text{V}; I_B=0\text{mA}$	I_{CEX}	-	-	1	μA
DC Current Gain	$I_C=120\text{mA},$ $V_{CE}=10\text{VDC}$	h_{FE}	10,000	-	-	
Saturation Voltage	$I_C=120\text{mA}$	$V_{CE(SAT)}$	-	-	1.5	V
Total Harmonic Distortion	$f_o=300\text{Hz @ -10dBm}$ $I_C=40\text{mA}$	-	-	-	-80	dB
Zener Characteristics @ 25°C						
Zener Voltage (Between pins 4+5 and 6+5)	$I_{ZT}=20\text{mA}$	V_Z	-	-	-	V
Zener Voltage (Between pins 12+11)	$I_{ZT}=20\text{mA}$	V_Z	-	-	-	V
Input to Output Capacitance	-	$C_{I/O}$	-	3	-	pF
Input to Output Isolation	-	$V_{I/O}$	3750	-	-	V_{RMS}

PERFORMANCE DATA*

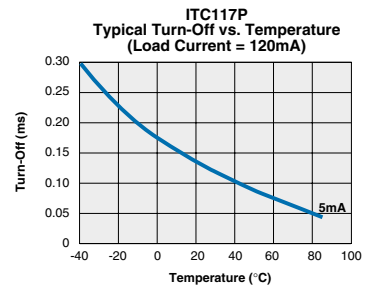
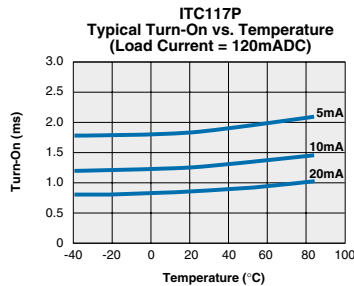
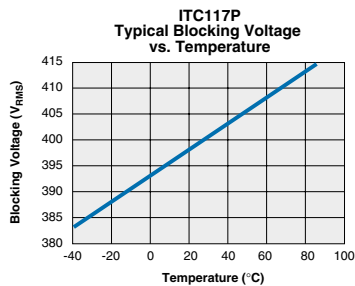
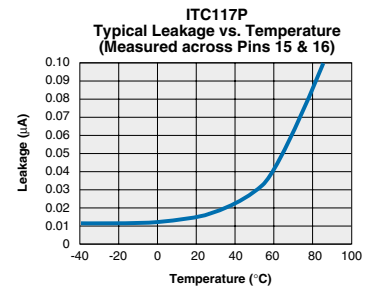
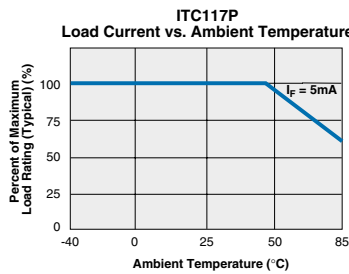
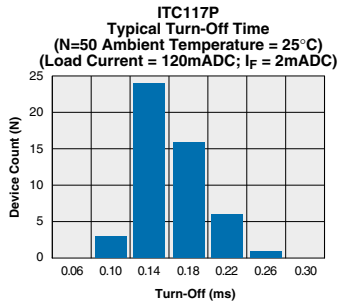
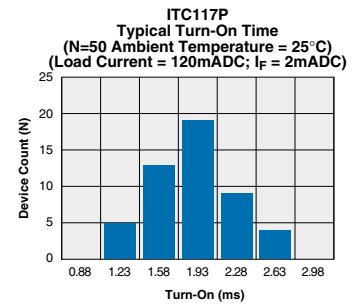
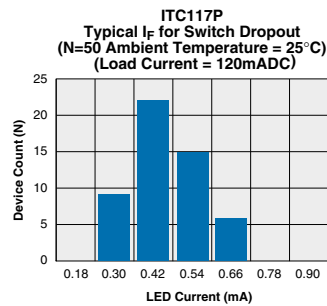
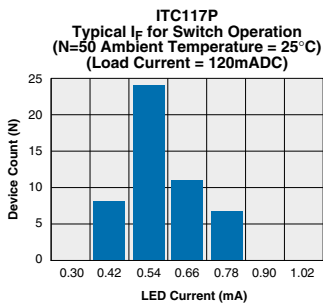
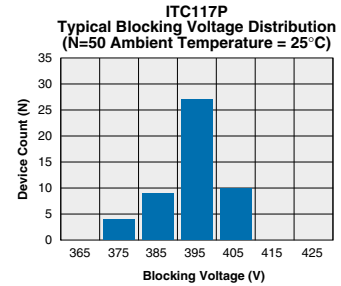
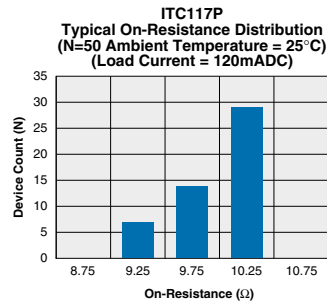
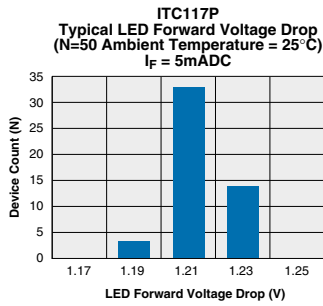

The Performance data shown in the graphs above is typical of device performance. For guaranteed parameters not indicated in the written specifications, please contact our application department.

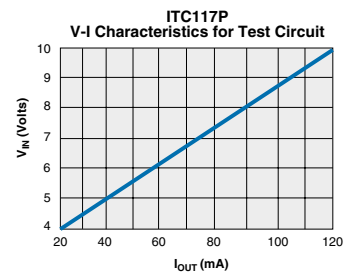
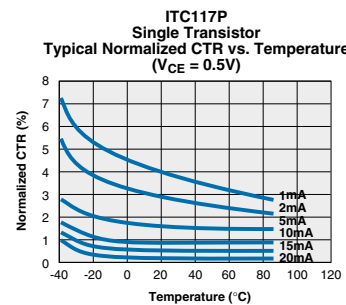
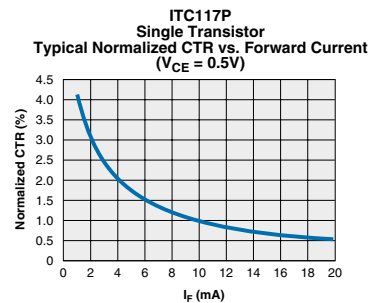
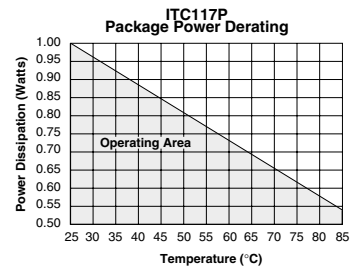
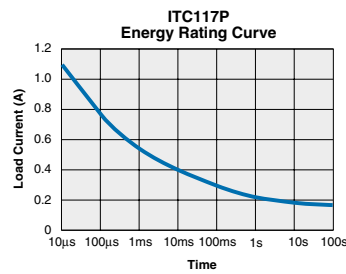
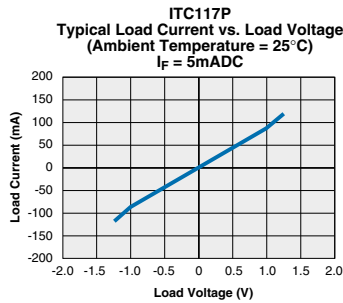
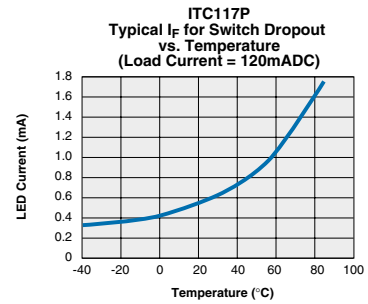
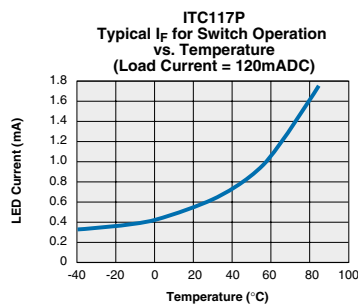
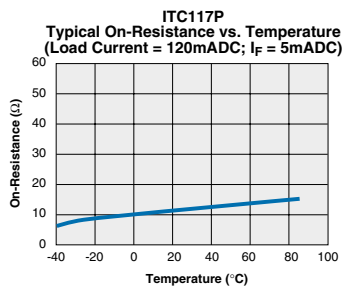
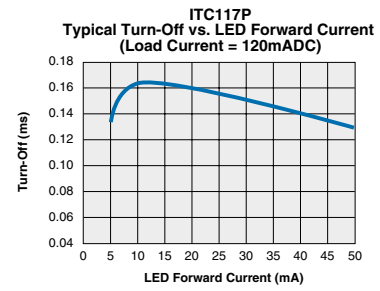
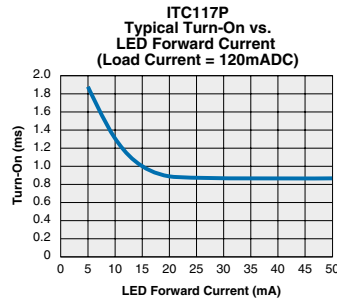
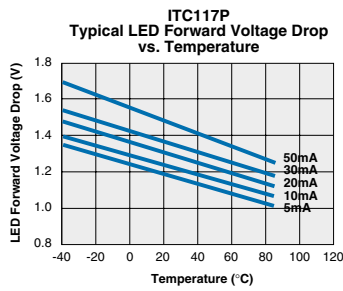
PERFORMANCE DATA*

*The Performance data shown in the graphs above is typical of device performance. For guaranteed parameters not indicated in the written specifications, please contact our application department.

PERFORMANCE DATA*

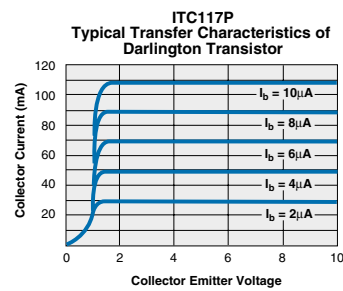
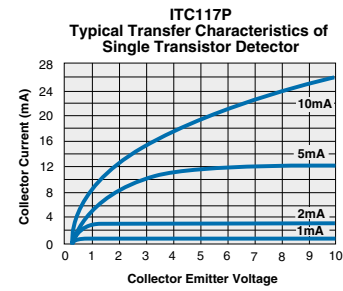
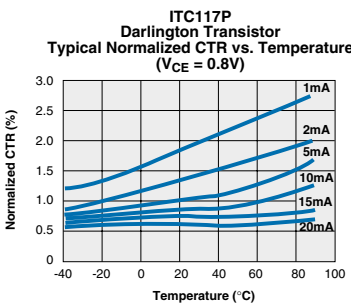
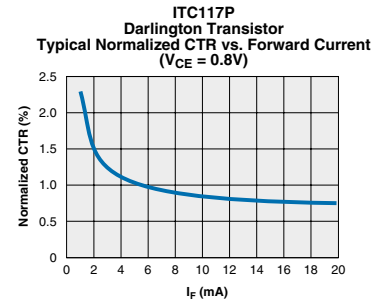
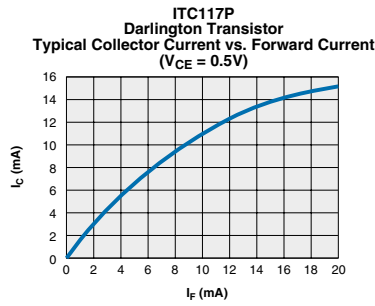
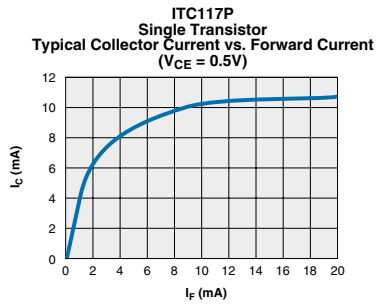

*The Performance data shown in the graphs above is typical of device performance. For guaranteed parameters not indicated in the written specifications, please contact our application department.

Mechanical Dimensions

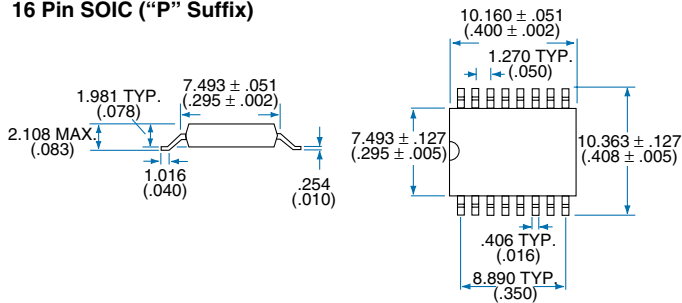
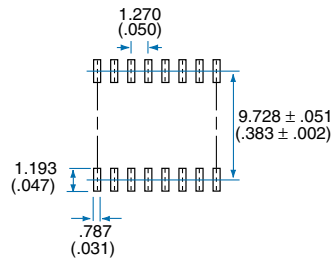
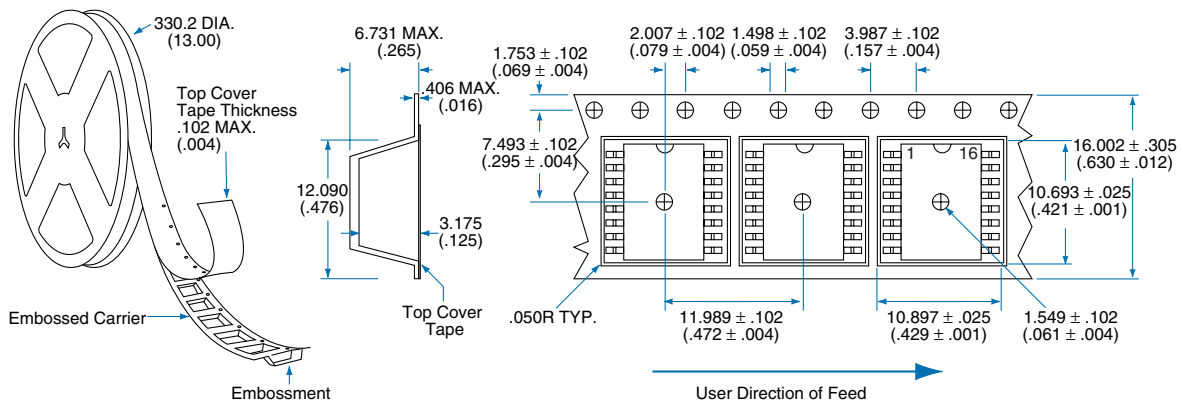
16 Pin SOIC ("P" Suffix)

PC Board Pattern (Top View)

Tape and Reel Packaging for 16 Pin SOIC Package

Dimensions
 mm
 (inches)

CLARE LOCATIONS

Clare Headquarters
78 Cherry Hill Drive
Beverly, MA 01915
Tel: 1-978-524-6700
Fax: 1-978-524-4900
Toll Free: 1-800-27-CLARE

Clare Micronix Division
145 Columbia
Aliso Viejo, CA 92656-1490
Tel: 1-949-831-4622
Fax: 1-949-831-4628

SALES OFFICES

AMERICAS

Americas Headquarters

Clare
78 Cherry Hill Drive
Beverly, MA 01915
Tel: 1-978-524-6700
Fax: 1-978-524-4900
Toll Free: 1-800-27-CLARE

Eastern Region

Clare
P.O. Box 856
Mahwah, NJ 07430
Tel: 1-201-236-0101
Fax: 1-201-236-8685
Toll Free: 1-800-27-CLARE

Central Region

Clare Canada Ltd.
3425 Harvester Road, Suite 202
Burlington, Ontario L7N 3N1
Tel: 1-905-333-9066
Fax: 1-905-333-1824

Western Region

Clare
1852 West 11th Street, #348
Tracy, CA 95376
Tel: 1-209-832-4367
Fax: 1-209-832-4732
Toll Free: 1-800-27-CLARE

Canada

Clare Canada Ltd.
3425 Harvester Road, Suite 202
Burlington, Ontario L7N 3N1
Tel: 1-905-333-9066
Fax: 1-905-333-1824

EUROPE

European Headquarters

CP Clare nv
Bampslaan 17
B-3500 Hasselt (Belgium)
Tel: 32-11-300868
Fax: 32-11-300890

France

Clare France Sales
Lead Rep
99 route de Versailles
91160 Champlan
France
Tel: 33 1 69 79 93 50
Fax: 33 1 69 79 93 59

Germany

Clare Germany Sales
ActiveComp Electronic GmbH
Mitterstrasse 12
85077 Manching
Germany
Tel: 49 8459 3214 10
Fax: 49 8459 3214 29

Italy

C.L.A.R.E.s.a.s.
Via C. Colombo 10/A
I-20066 Melzo (Milano)
Tel: 39-02-95737160
Fax: 39-02-95738829

Sweden

Clare Sales
Comptronic AB
Box 167
S-16329 Spånga
Tel: 46-862-10370
Fax: 46-862-10371

United Kingdom

Clare UK Sales
Marco Polo House
Cook Way
Bindon Road
Taunton
UK-Somerset TA2 6BG
Tel: 44-1-823 352541
Fax: 44-1-823 352797

ASIA/PACIFIC

Asian Headquarters

Clare
Room N1016, Chia-Hsin, Bldg II,
10F, No. 96, Sec. 2
Chung Shan North Road
Taipei, Taiwan R.O.C.
Tel: 886-2-2523-6368
Fax: 886-2-2523-6369

<http://www.clare.com>

Clare cannot assume responsibility for use of any circuitry other than circuitry entirely embodied in this Clare product. No circuit patent licenses nor indemnity are expressed or implied. Clare reserves the right to change the specification and circuitry, without notice at any time. The products described in this document are not intended for use in medical implantation or other direct life support applications where malfunction may result in direct physical harm, injury or death to a person.

Specification: DS-ITC117-Rxx
©Copyright 2000, Clare, Inc.
OptoMOS® is a registered trademark of Clare, Inc.
All rights reserved. Printed in USA.
3/22/01