

#### USB-A-S-RA

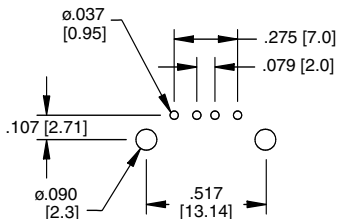

Recommended PCB Layout

#### USB-A-S-RA-SMT

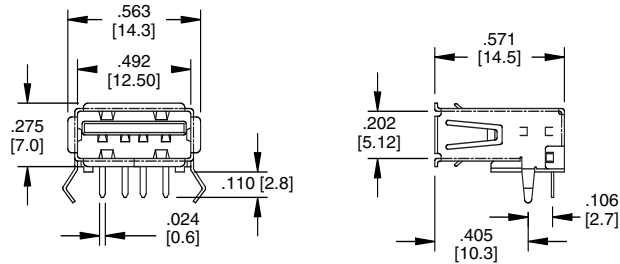
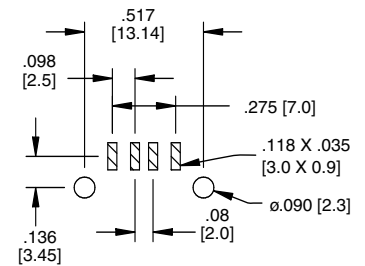
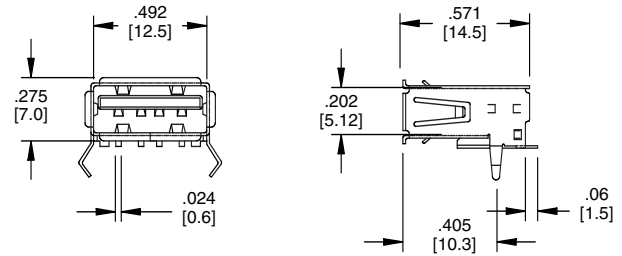

Recommended PCB Layout

#### USB-A-S-VT

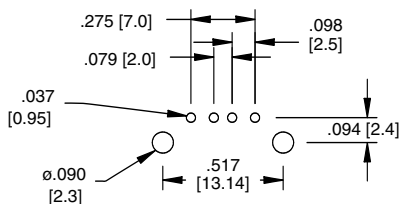
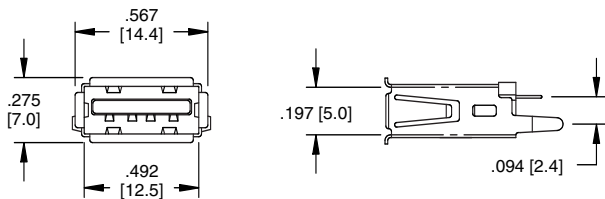
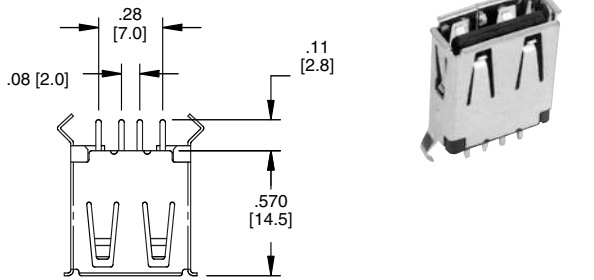

Recommended PCB Layout  
(Bottom View)

#### USB-A-S-RA-TSMT

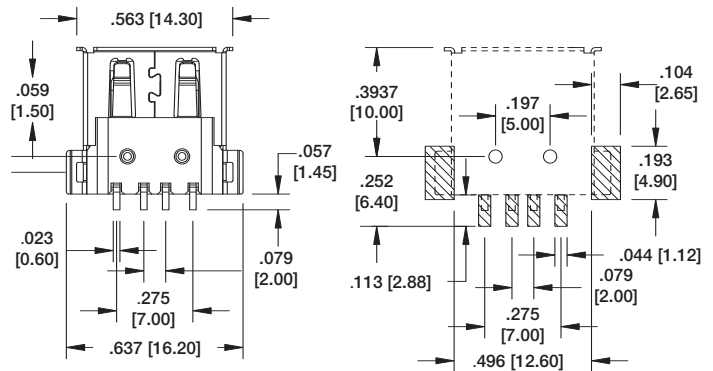
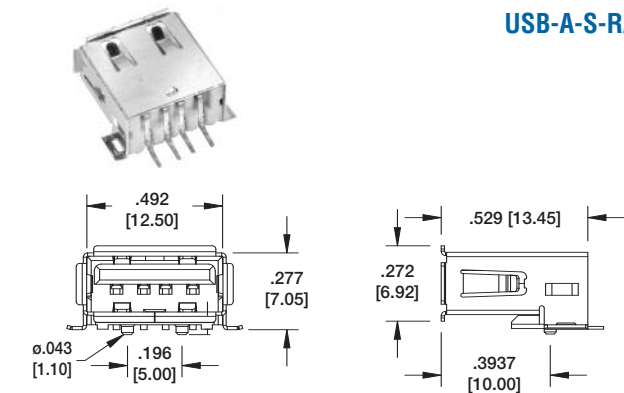

Recommended PCB Layout

#### USB-A-S-RU

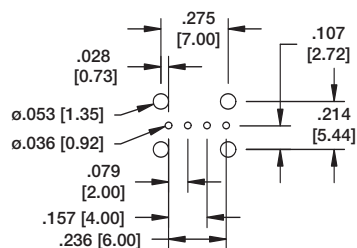
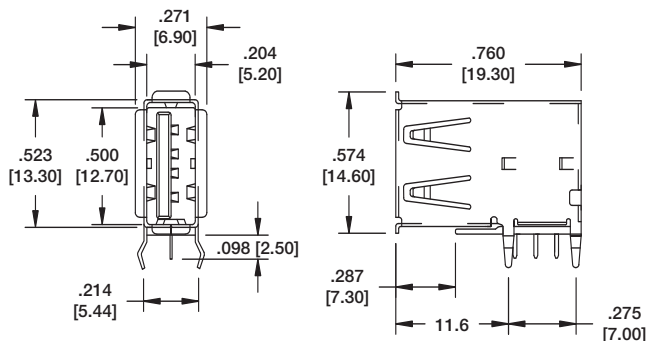

Recommended PCB Layout



#### USB-A-S-RA-FS

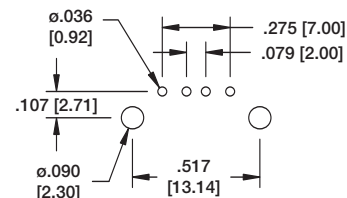
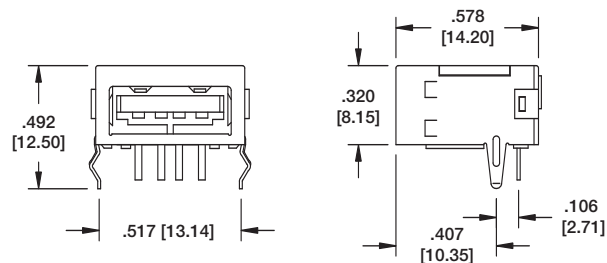

Recommended PCB Layout



#### USB-AP-S-RA

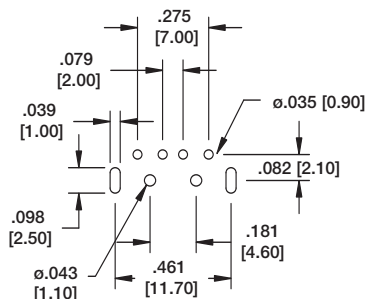
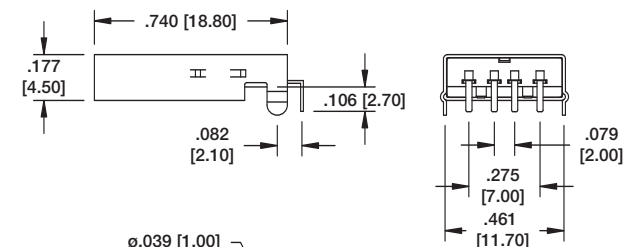

Recommended PCB Layout



#### USB-AP-S-RA-SMT

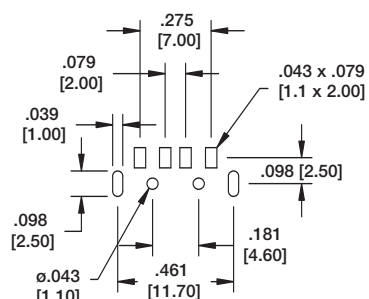
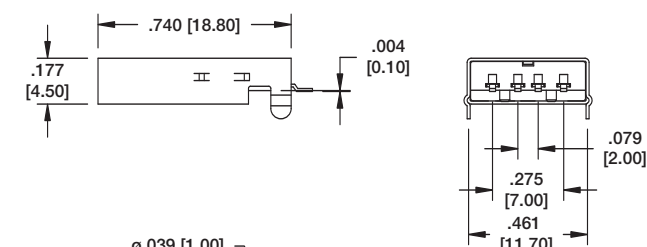

Recommended PCB Layout

