

## Low Noise and Medium Power Packaged GaAs FETs

### FEATURES

- 0.9 dB Typical Noise Figure at 12 GHz
- High Associated Gain:  $G_a = 9$  dB Typical at 12 GHz
- 24.5 dBm Typical Power at 12 GHz
- 10 dB Typical Linear Power Gain at 12 GHz
- Breakdown Voltage :  $BV_{DGO} \geq 9$  V
- $L_g = 0.25 \mu\text{m}$ ,  $W_g = 600 \mu\text{m}$
- Tight  $V_p$  ranges control
- High RF input power handling capability
- 100 % DC Tested
- Micro-X Metal Ceramic Package

### PHOTO ENLARGEMENT



### DESCRIPTION

The TC2381 is a high performance field effect transistor housed in a ceramic micro-x package with TC1301 PHEMT Chip. It has very low noise figure, high associated gain and high dynamic range that makes this device suitable for use in low noise amplifiers. All devices are 100 % DC tested to assure consistent quality.

### ELECTRICAL SPECIFICATIONS ( $T_A = 25^\circ\text{C}$ )

Symbol	CONDITIONS	MIN	TYP	MAX	UNIT
NF	Noise Figure at $V_{DS} = 4$ V, $I_{DS} = 50$ mA, $f = 12$ GHz		0.9	1.2	dB
$G_a$	Associated Gain at $V_{DS} = 4$ V, $I_{DS} = 50$ mA, $f = 12$ GHz	7.5	9		dB
$P_{1dB}$	Output Power at 1dB Gain Compression Point, $f = 12$ GHz $V_{DS} = 6$ V, $I_{DS} = 80$ mA	23.5	24.5		dBm
$G_L$	Linear Power Gain, $f = 12$ GHz $V_{DS} = 6$ V, $I_{DS} = 80$ mA	9	10		dB
$I_{DSS}$	Saturated Drain-Source Current at $V_{DS} = 2$ V, $V_{GS} = 0$ V		180		mA
$g_m$	Transconductance at $V_{DS} = 2$ V, $V_{GS} = 0$ V		200		mS
$V_p$	Pinch-off Voltage at $V_{DS} = 2$ V, $I_D = 1.2$ mA		-1.0*		Volts
$BV_{DGO}$	Drain-Gate Breakdown Voltage at $I_{DGO} = 0.3$ mA	9	12		Volts
$R_{th}$	Thermal Resistance		75		$^\circ\text{C}/\text{W}$

### ABSOLUTE MAXIMUM RATINGS ( $T_A = 25^\circ\text{C}$ )

Symbol	Parameter	Rating
$V_{DS}$	Drain-Source Voltage	7.0 V
$V_{GS}$	Gate-Source Voltage	-3.0 V
$I_{DS}$	Drain Current	$I_{DSS}$
$I_{GS}$	Gate Current	600 $\mu\text{A}$
$P_{in}$	RF Input Power, CW	24dBm
$P_T$	Continuous Dissipation	800 mW
$T_{CH}$	Channel Temperature	175 $^\circ\text{C}$
$T_{STG}$	Storage Temperature	- 65 $^\circ\text{C}$ to +175 $^\circ\text{C}$

### TYPICAL NOISE PARAMETERS ( $T_A = 25^\circ\text{C}$ )

$V_{DS} = 4$  V,  $I_{DS} = 50$  mA

Frequency	NF <sub>opt</sub>	$G_A$	$\Gamma_{opt}$		Rn/50
			MAG	ANG	
2	0.36	19.7	0.80	15	0.28
4	0.48	16.6	0.67	39	0.18
6	0.59	14.3	0.56	64	0.15
8	0.70	12.7	0.49	92	0.12
10	0.82	11.7	0.46	120	0.09
12	0.93	10.9	0.45	148	0.06
14	1.05	10.4	0.46	174	0.04
16	1.16	9.8	0.47	-162	0.04
18	1.27	9.0	0.48	-141	0.07

\* For the tight control of the pinch-off voltage range, we divide TC2381 into 3 model numbers to fit customer design requirement

(1)TC2381P0710 :  $V_p = -0.7\text{V}$  to  $-1.0\text{V}$  (2)TC2381P0811 :  $V_p = -0.8\text{V}$  to  $-1.1\text{V}$  (3)TC2381P0912 :  $V_p = -0.9\text{V}$  to  $-1.2\text{V}$

If required, customer can specify the requirement in purchasing document. For special  $V_p$  requirement, please contact factory for details.

**TYPICAL SCATTERING PARAMETERS (T<sub>A</sub>=25 °C)**

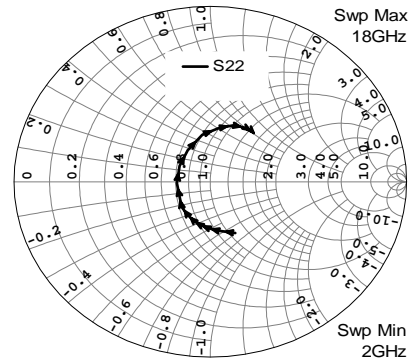
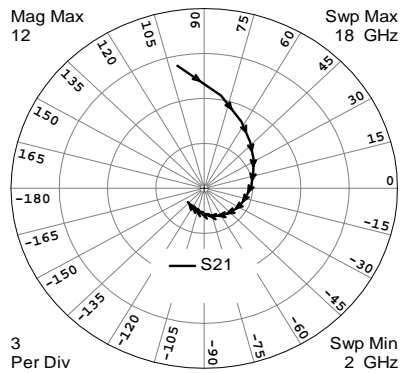
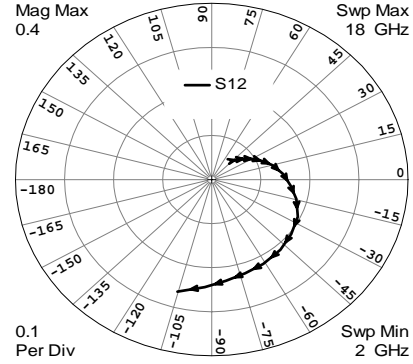
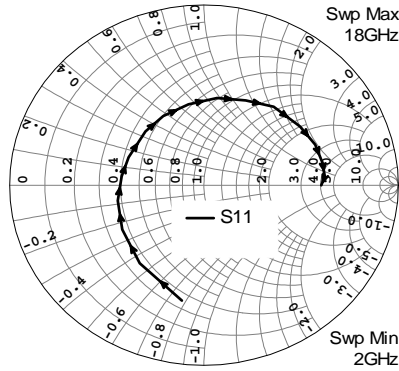
 V<sub>DS</sub> = 4 V, I<sub>DS</sub> = 50 mA

FREQUENCY (GHz)	S11		S21		S12		S22	
	MAG	ANG	MAG	ANG	MAG	ANG	MAG	ANG
2	0.6511	-99.96	8.3572	101.52	0.0571	47.57	0.3190	-66.58
3	0.5448	-127.21	6.2858	80.33	0.0719	39.64	0.2811	-82.21
4	0.4866	-149.57	5.0186	62.60	0.0856	33.78	0.2636	-93.01
5	0.4510	-169.05	4.1923	47.09	0.0998	27.84	0.2517	-101.70
6	0.4253	173.38	3.6280	32.52	0.1146	20.88	0.2390	-110.32
7	0.4173	158.32	3.2078	18.74	0.1293	14.32	0.2231	-120.54
8	0.4230	135.30	2.9115	2.09	0.1466	4.60	0.2048	-134.99
9	0.4359	118.61	2.6640	-11.99	0.1614	-4.97	0.1775	-151.30
10	0.4561	100.08	2.4977	-26.76	0.1777	-14.33	0.1706	-177.33
11	0.4887	82.07	2.3079	-41.54	0.1947	-25.54	0.1810	149.72
12	0.5176	65.47	2.1434	-56.28	0.2039	-37.36	0.2137	122.58
13	0.5637	50.54	1.9663	-71.85	0.2121	-48.67	0.2706	98.72
14	0.5924	33.25	1.7903	-87.78	0.2188	-61.32	0.3097	81.74
15	0.6148	21.44	1.6349	-101.50	0.2236	-72.24	0.3432	69.74
16	0.6229	11.63	1.4988	-114.56	0.2320	-82.78	0.3569	59.19
17	0.6237	4.42	1.4189	-126.43	0.2448	-93.31	0.3570	52.92
18	0.6042	-0.13	1.3608	-137.83	0.2638	-105.35	0.3549	51.32

**TYPICAL SCATTERING PARAMETERS (T<sub>A</sub>=25 °C)**

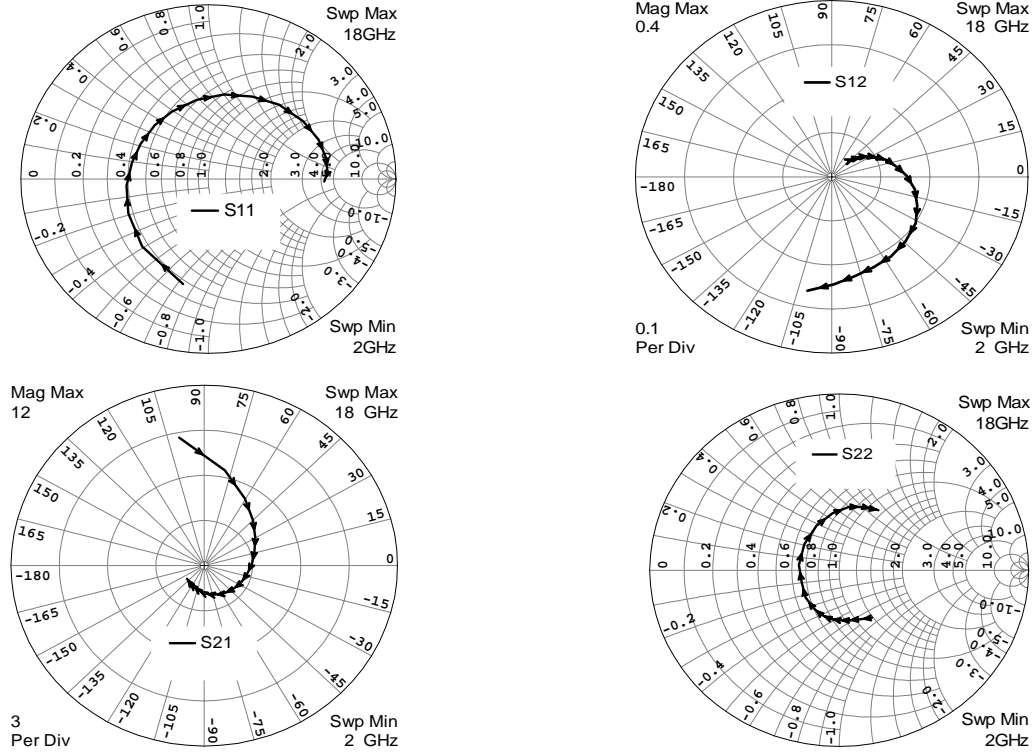
 V<sub>DS</sub> = 6 V, I<sub>DS</sub> = 80 mA

FREQUENCY (GHz)	S11		S21		S12		S22	
	MAG	ANG	MAG	ANG	MAG	ANG	MAG	ANG
2	0.6183	-102.64	8.6490	100.37	0.0499	46.94	0.3207	-57.10
3	0.5239	-132.35	6.4622	78.52	0.0637	40.89	0.2957	-71.54
4	0.4704	-155.25	5.1337	60.63	0.0770	36.12	0.2875	-82.05
5	0.4384	-174.90	4.2774	45.02	0.0906	30.57	0.2838	-90.87
6	0.4175	167.15	3.6792	30.29	0.1049	24.35	0.2798	-99.97
7	0.4131	150.72	3.2553	16.44	0.1201	18.00	0.2697	-111.07
8	0.4205	132.88	2.9462	1.05	0.1360	8.75	0.2542	-122.33
9	0.4323	116.75	2.7095	-13.02	0.1525	0.88	0.2361	-139.09
10	0.4585	97.92	2.5441	-28.12	0.1718	-9.47	0.2092	-161.08
11	0.4917	80.17	2.3562	-43.08	0.1864	-20.54	0.2154	171.92
12	0.5264	63.71	2.2052	-58.30	0.2012	-31.76	0.2369	141.22
13	0.5683	48.51	2.0206	-74.23	0.2099	-44.24	0.2793	115.60
14	0.6044	33.21	1.8459	-89.91	0.2172	-56.29	0.3254	96.01
15	0.6288	21.09	1.6685	-103.89	0.2225	-67.41	0.3638	81.71
16	0.6374	11.15	1.5246	-117.34	0.2305	-78.35	0.3815	69.99
17	0.6372	3.56	1.4293	-129.39	0.2442	-88.95	0.3903	62.63
18	0.6181	-1.31	1.3693	-140.61	0.2634	-100.77	0.3994	58.72

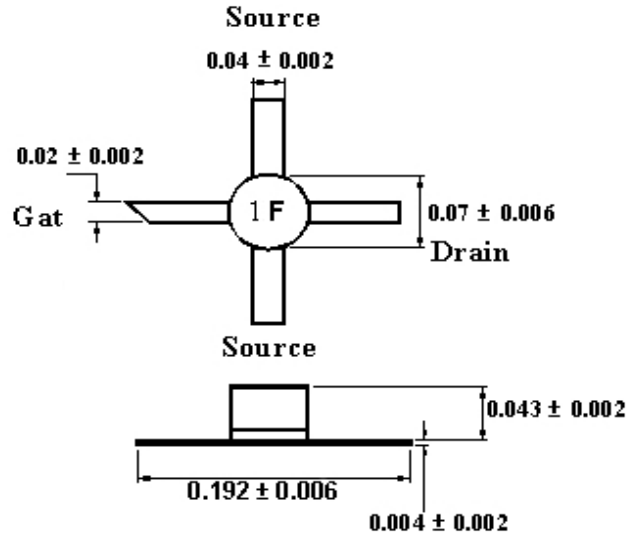
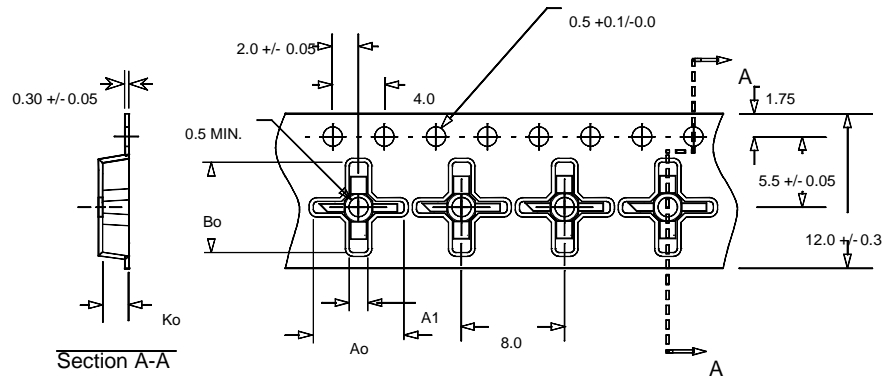
**OUTLINE DIMENSIONS (Unit: inch)**

**Tape & Reel Package Orientation (Unit: mm)**

Ao = 7.0 mm  
 A1 = 1.45 mm  
 Bo = 7.0 mm  
 B1 = 0.9 mm  
 Ko = 2.0 mm

Standard Reel Size	7"
Standard Reel Quantity	1000