

Monolithic Voltage-Controlled Oscillators

General Description

The MAX2622/MAX2623/MAX2624 self-contained voltage-controlled oscillators (VCOs) combine an integrated oscillator and output buffer in a miniature 8-pin μ MAX package.

The inductor and varactor elements of the tank circuits are integrated on-chip, greatly simplifying application of the part. In addition, the center frequency of oscillation and frequency span are factory preset to provide a guaranteed frequency range versus control voltage. An external tuning voltage controls the oscillation frequency. The output signals are buffered by an amplifier stage matched on-chip to 50Ω .

The MAX2622/MAX2623/MAX2624 operate from a +2.7V to +5.5V supply voltage and require only 8mA of supply current. In shutdown mode, the supply current is reduced to $0.1\mu\text{A}$.

Applications

866MHz to 868MHz European ISM Band (MAX2622)

DECT 1/2 Frequency LO (MAX2623)

902MHz to 928MHz ISM Band, $\pm 10.7\text{MHz}$ IF (MAX2623)

902MHz to 928MHz ISM Band, 45MHz to 70MHz IF (MAX2624)

Features

- ◆ Fully Monolithic
- ◆ Guaranteed Performance
- ◆ On-Chip 50Ω Output Match
- ◆ Wide Choice of Frequencies
 - 855MHz to 881MHz (MAX2622)
 - 885MHz to 950MHz (MAX2623)
 - 947MHz to 998MHz (MAX2624)
- ◆ +2.7V to +5.5V Single-Supply Operation
- ◆ Low-Current Shutdown Mode
- ◆ Smaller than Modules (8-Pin μ MAX Package)

Ordering Information

PART	TEMP. RANGE	PIN-PACKAGE
MAX2622EUA	-40°C to +85°C	8 μ MAX
MAX2623EUA	-40°C to +85°C	8 μ MAX
MAX2624EUA	-40°C to +85°C	8 μ MAX

Pin Configuration appears at end of data sheet.

Typical Operating Circuit

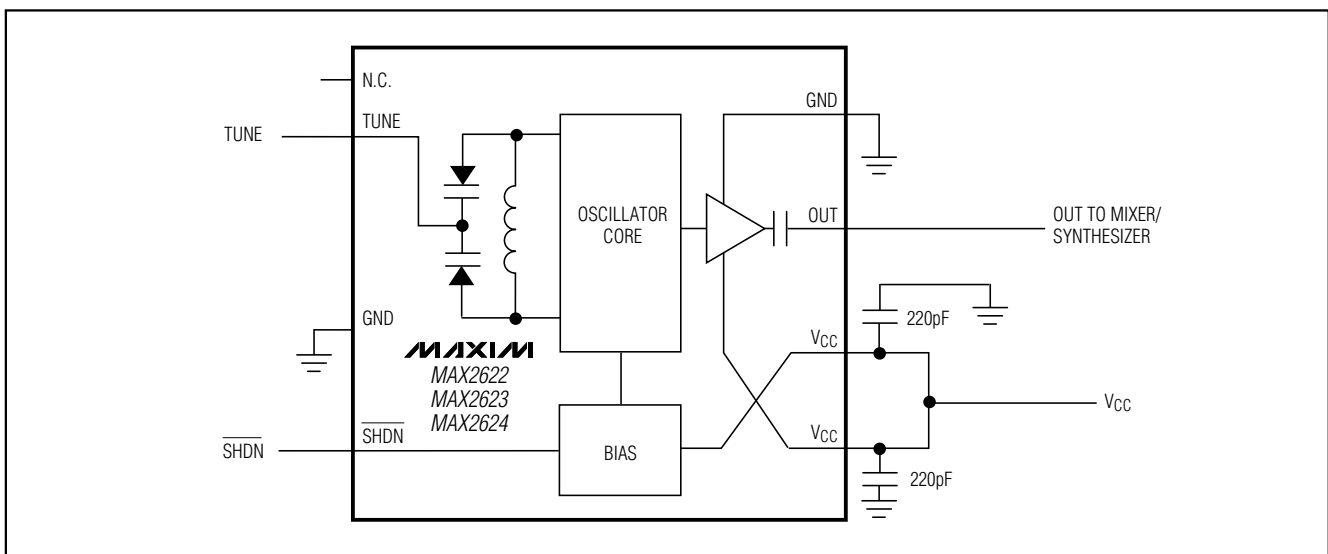

Monolithic Voltage-Controlled Oscillators

ABSOLUTE MAXIMUM RATINGS

V _{CC} to GND	-0.3V to +6V	Operating Temperature Range	-40°C to +85°C
TUNE, $\overline{\text{SHDN}}$ to GND	-0.3V to (V _{CC} + 0.3V)	Junction Temperature	+150°C
OUT to GND	-0.3V to (V _{CC} + 0.6V)	Storage Temperature Range	-65°C to +150°C
Continuous Power Dissipation (T _A = +70°C)		Lead Temperature (soldering, 10s)	+300°C
8-Pin μ MAX (derate 5.7mW/°C above T _A = +70°C).....	457mW		

Stresses beyond those listed under "Absolute Maximum Ratings" may cause permanent damage to the device. These are stress ratings only, and functional operation of the device at these or any other conditions beyond those indicated in the operational sections of the specifications is not implied. Exposure to absolute maximum rating conditions for extended periods may affect device reliability.

DC ELECTRICAL CHARACTERISTICS

(Typical Operating Circuit, V_{CC} = +2.7V to +5.5V, V_{TUNE} = 1.4V, V $\overline{\text{SHDN}}$ = 2V, OUT = unconnected, T_A = -40°C to +85°C, unless otherwise noted. Typical values are at V_{CC} = +3V, T_A = +25°C.) (Note 1)

PARAMETER	CONDITIONS	MIN	TYP	MAX	UNITS
Supply Voltage		2.7		5.5	V
Supply Current			8	11.5	mA
Shutdown Supply Current	V $\overline{\text{SHDN}}$ \leq 0.6V		0.1	5	μ A
$\overline{\text{SHDN}}$ Input Voltage Low				0.6	V
$\overline{\text{SHDN}}$ Input Voltage High		2.0			V
$\overline{\text{SHDN}}$ Input Current Low	V $\overline{\text{SHDN}}$ \leq 0.6V	-0.5		0.5	μ A
$\overline{\text{SHDN}}$ Input Current High	V $\overline{\text{SHDN}}$ \geq 2.0V	-0.5		0.5	μ A
TUNE Input Current	0.4V \leq V _{TUNE} \leq 2.4V		0.01		nA

AC ELECTRICAL CHARACTERISTICS

(Typical Operating Circuit, V_{CC} = +2.7V to +5.5V, V_{TUNE} = 0.4V to 2.4V, V $\overline{\text{SHDN}}$ = 2V, T_A = +25°C, unless otherwise noted. Typical values measured at V_{CC} = +3V.) (Note 1)

PARAMETER	CONDITIONS	MIN	TYP	MAX	UNITS
Oscillator Frequency Range	MAX2622, V _{TUNE} = 0.4V to 2.4V, T _A = -40°C to +85°C	855		881	MHz
	MAX2623, V _{TUNE} = 0.4V to 2.4V, T _A = -20°C to +75°C	885		950	
	MAX2624, V _{TUNE} = 0.4V to 2.4V, T _A = -40°C to +85°C	947		998	
Phase Noise	f _{OFFSET} = 100kHz		-101		dBc/Hz
	f _{OFFSET} = 1MHz		-119		
Noise Floor			-151		dBm/Hz
Maximum Tuning Gain (Note 2)	V _{TUNE} = 0.4V to 2.4V		75	100	MHz/V
Output Power	V _{TUNE} = 0.4V (Note 3)		-3		dBm
Return Loss (Note 3)			-10		dB
Harmonics			-27		dBc
Load Pulling	V _{SWR} = 2:1, all phases		0.75		MHz _{p-p}
Supply Pushing	V _{CC} stepped from 2.8V to 3.3V		280		kHz/V

Note 1: Specifications are production tested at T_A = +25°C. Limits over temperature are guaranteed by design and characterization.

Note 2: Tuning gain is measured at V_{TUNE} = 0.4V with a 0.2V step to 0.6V. At low V_{TUNE}, tuning gain is highest.

Note 3: Measurements taken on MAX2622_EV kit.

Monolithic Voltage-Controlled Oscillators

Typical Operating Characteristics

($V_{CC} = +3.0V$, $V_{TUNE} = 0.4V$ to $2.4V$, $V_{SHDN} = 2V$, $T_A = +25^\circ C$, unless otherwise noted.)

MAX2622/MAX2623/MAX2624

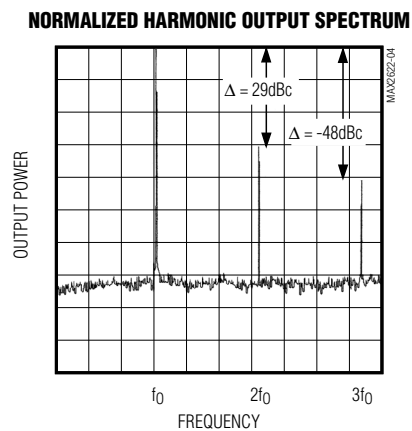
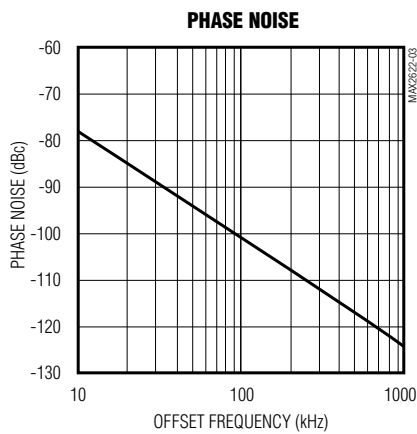
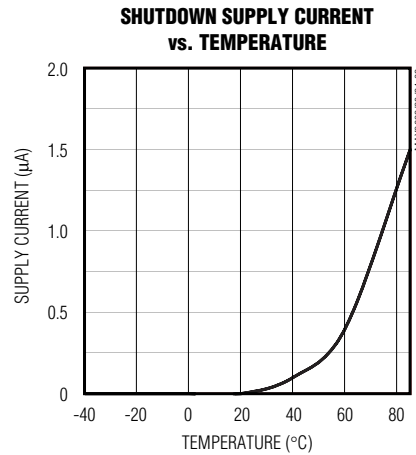
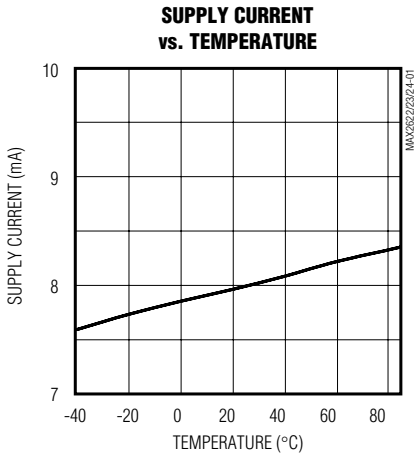
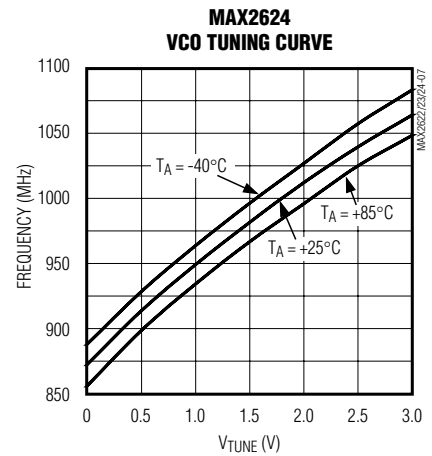
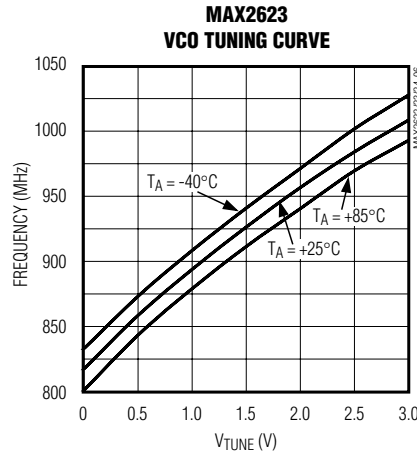
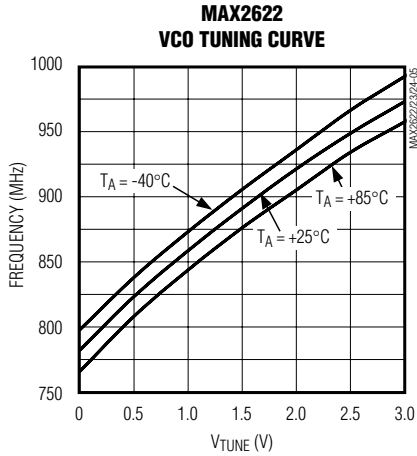

Monolithic Voltage-Controlled Oscillators

Pin Description

PIN	NAME	FUNCTION
1	N.C.	No Connection. Not internally connected.
2	TUNE	Oscillator Frequency Tuning Voltage Input. High-impedance input with a voltage input range of 0.4V (low frequency) to 2.4V (high frequency) adjustment.
3	GND	Ground Connection for Oscillator and Biasing. Requires a low-inductance connection to the circuit board ground plane.
4	$\overline{\text{SHDN}}$	Shutdown Logic Input. A high-impedance input logic level low disables the device and reduces supply current to 0.1 μ A. A logic level high enables the device.
5	VCC	Output Buffer DC Supply Voltage Connection. Bypass with a 220pF capacitor to GND for best high-frequency performance.
6	VCC	Bias and Oscillator DC Supply Voltage Connection. Bypass with a 220pF capacitor to GND for low noise and low spurious content performance from the oscillator.
7	OUT	Buffered Oscillator Output
8	GND	Ground Connection for Output Buffer. Requires a low-inductance connection to the circuit board ground plane.

Detailed Description

Oscillator

The MAX2622/MAX2623/MAX2624 VCOs are implemented as an LC oscillator topology, integrating all of the tank components on-chip. This fully monolithic approach provides an extremely easy-to-use VCO, equivalent to a VCO module. The frequency is controlled by a voltage applied to the TUNE pin, which is internally connected to the varactor. The VCO core uses a differential topology to provide a stable frequency versus supply voltage and improve the immunity to load variations. In addition, there is a buffer amplifier following the oscillator core to provide added isolation from load variations and to boost the output power.

Output Buffer

The oscillator signal from the core drives an output buffer amplifier. The amplifier is constructed as a common-emitter stage with an integrated on-chip reactive output match. No external DC blocking capacitor is required, eliminating the need for any external components. The output amplifier has its own VCC and GND pins to minimize load-pulling effects. The amplifier boosts the oscillator signal to a level suitable for driving most RF mixers.

Applications Information

Tune Input

The tuning input is typically connected to the output of the PLL loop filter. The loop filter is presumed to provide an appropriately low-impedance source. It may incorporate an extra RC filter stage to reduce high-frequency noise and spurious signals. Any excess noise on the tuning input is directly translated into FM noise, which can degrade the phase-noise performance of the oscillator. Therefore, it is important to minimize the noise introduced on the tuning input. A simple RC filter with low corner frequency is needed during testing in order to filter the noise present on the voltage source driving the tuning line.

Layout Issues

Always use controlled impedance lines (microstrip, coplanar waveguide, etc.) for high-frequency signals. Always place decoupling capacitors as close to the VCC pins as possible; for long VCC lines, it may be necessary to add additional decoupling capacitors located further from the device. Always provide a low-inductance path to ground, and keep GND vias as close to the device as possible. Thermal reliefs on GND pads are **not** recommended.

Monolithic Voltage-Controlled Oscillators

MAX2622/MAX2623/MAX2624



Figure 1. Typical Application Circuit

Pin Configuration



Monolithic Voltage-Controlled Oscillators

Package Information

	INCHES		MILLIMETERS		JEDEC			
	MIN	MAX	MIN	MAX	MIN	MAX	MIN	MAX
A	0.037	0.043	0.94	1.10	---	0.043	---	1.10
A1	0.002	0.006	0.05	0.15	0.002	0.006	0.05	0.15
B	0.010	0.014	0.25	0.36	0.010	0.016	0.25	0.40
C	0.005	0.007	0.13	0.18	0.005	0.009	0.13	0.23
D	0.116	0.120	2.95	3.05	0.114	0.122	2.9	3.1
e	0.0256	BSC	0.65	BSC	0.0256	BSC	0.64	BSC
E	0.116	0.120	2.95	3.05	0.114	0.122	2.9	3.1
H	0.188	0.198	4.78	5.03	0.193	BSC	4.9	BSC
L	0.016	0.026	0.41	0.66	0.016	0.027	0.40	0.70
α	0°	6°	0°	6°	0°	6°	0°	6°
*X	0.087	0.099	2.210	2.515				
*Y	0.062	0.074	1.575	1.880				

* EXPOSED PAD (Note 5)

8LUMAXD EPS

NOTES:

- D&E DO NOT INCLUDE MOLD FLASH.
- MOLD FLASH OR PROTRUSIONS NOT TO EXCEED .15 MM (.006").
- CONTROLLING DIMENSION: MILLIMETERS.
- MEETS JEDEC MO-187.
- DIMENSIONS X & Y APPLY TO EXPOSED PAD (EP) VERSIONS ONLY. SEE INDIVIDUAL PRODUCT DATASHEET TO DETERMINE IF A PRODUCT USES EXPOSED PAD PACKAGE.
- EXPOSED PAD FLUSH WITH BOTTOM OF PACKAGE WITHIN .002".

PROPRIETARY INFORMATION

TITLE: PACKAGE OUTLINE, 8L μ MAX WITH EP OPTION

APPROVAL	DOCUMENT CONTROL NO. 21-0036	REV H 1/1
----------	---------------------------------	--------------