

LNAs with Step Attenuator and VGA

General Description

The MAX2371/MAX2373 wideband low-noise amplifier (LNA) ICs are designed for direct conversion receiver (DCR) or very low intermediate frequency (VLIF) receiver applications. They contain single-channel, single-ended LNAs with switchable attenuator and automatic gain control (AGC) intended as a low-noise gain stage. These devices provide high gain-control range (typically 60dB) at radio frequency (RF) with excellent noise and reverse isolation characteristics.

The MAX2371/MAX2373 can work over the frequency range from 100MHz to 1GHz. In practice, only a narrow band is needed in each application, so different matching circuits can be applied. The devices are dynamically configured through the digital/analog control pins to select either maximum gain and low noise figure or power-saving mode. In addition, the MAX2371/MAX2373 feature high/low-current modes, high/low attenuation modes, linearly controlled gain states, and shutdown mode.

Applications

Direct Conversion Receiver (DCR)
Very Low IF Receiver

Features

- ◆ Low Noise Figure (1.8dB typical)
- ◆ High Small-Signal Gain (15dB Nominal)
- ◆ Wide Frequency Range of Operation (100MHz to 1GHz)
- ◆ 20dB Step Attenuator
- ◆ 45dB AGC Range Excluding Step Attenuator
- ◆ 2.65V to 3.3V Single-Supply Operation
- ◆ Shutdown Mode
- ◆ 3.5mA Supply Current, Adjustable Down to 2.5mA
- ◆ 40dB Reverse Isolation

Ordering Information

PART	TEMP RANGE	PIN-PACKAGE	PKG CODE
MAX2371EGC	-40°C to +85°C	12 QFN-EP*	G1233-1
MAX2371ETC	-40°C to +85°C	12 TQFN-EP*	T1233-3
MAX2371ETC+	-40°C to +85°C	12 TQFN-EP*	T1233+3
MAX2373EGC	-40°C to +85°C	12 QFN-EP*	G1233-1
MAX2373ETC	-40°C to +85°C	12 TQFN-EP*	T1233-3
MAX2373ETC+	-40°C to +85°C	12 TQFN-EP*	T1233+3

*EP = Exposed pad.

+Denotes lead-free package.

Pin Configuration

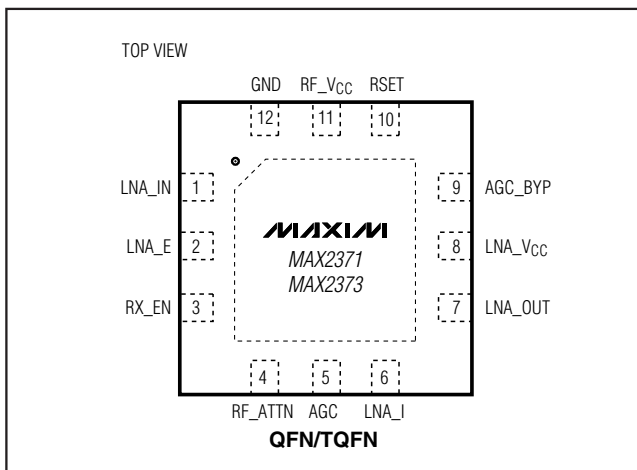

Functional Diagram

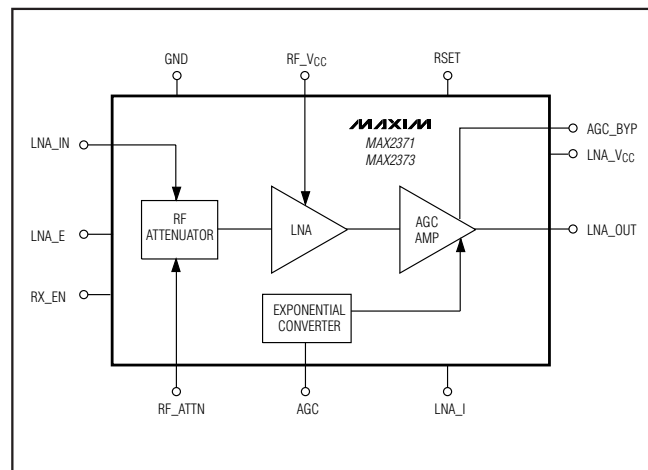

LNAs with Step Attenuator and VGA

ABSOLUTE MAXIMUM RATINGS

V_{CC} to GND-0.3V to +3.6V
 All Pins Excluding Grounds to Pin GND.....-0.3V to (V_{CC} + 0.3V)
 LNA Input Power (RX_EN = low)5dBm
 Continuous Power Dissipation (T_A = +70°C)
 12-Pin QFN (derate 11.9mW/°C above +70°C)952mW

Operating Temperature Range-40°C to +85°C
 Junction Temperature+150°C
 Storage Temperature Range-65°C to +160°C
 Soldering Temperature (10s)+300°C

Stresses beyond those listed under "Absolute Maximum Ratings" may cause permanent damage to the device. These are stress ratings only, and functional operation of the device at these or any other conditions beyond those indicated in the operational sections of the specifications is not implied. Exposure to absolute maximum rating conditions for extended periods may affect device reliability.

DC ELECTRICAL CHARACTERISTICS

(V_{CC} = 2.775V, RX_EN = high, R_{SET} = 1.1kΩ, V_{AGC} = V_{CC}/2, T_A = -40°C to +85°C. Typical values are at T_A = +25°C, unless otherwise noted.)

PARAMETER	SYMBOL	CONDITIONS	MIN	TYP	MAX	UNITS
Supply Voltage	V _{CC}		2.65	2.775	3.30	V
Supply Current	I _{CC}	RX_EN = low, V _{CC} = 3.3V		0.5	20	μA
		LNA_I = high, RF_ATTEN = low		3.5	5.5	mA
		LNA_I = low		2.5	3.5	mA
Digital Input Logic High	V _{IH}	Pins LNA_I, RF_ATTEN, RX_EN	0.7 × V _{CC}		V _{CC}	V
Digital Input Logic Low	V _{IL}	Pins LNA_I, RF_ATTEN, RX_EN	0	0.3 × V _{CC}		V
Logic Pin Impedance		Logic pins RX_EN, RF_ATTEN, LNA_I	50			kΩ
AGC Pin Impedance		Pins AGC	100			kΩ

AC ELECTRICAL CHARACTERISTICS

(MAX2371/MAX2373 EV Kits, V_{CC} = 2.65V to 3.3V, RX_EN = high, R_{SET} = 1.1kΩ, T_A = -40°C to +85°C. Typical values are at V_{CC} = 2.775V; for MAX2371 f_{RF} = 150MHz, for MAX2373 f_{RF} = 850MHz to 940MHz; T_A = +25°C, unless otherwise noted.) (Note 1)

PARAMETER	CONDITIONS		MIN	TYP	MAX	UNITS
LNA AND AGC AMP CHARACTERISTICS						
Radio Frequency Range (Note 2)	Low band (MAX2371)		136	150	174	MHz
	High band (MAX2373)		850	900	940	
Input Return Loss (S11) (Note 3)	LNA_I = high; RF_ATTEN = low	MAX2371		-12	-9.5	dB
		MAX2373		-15	-9.5	
	LNA_I = high; RF_ATTEN = high	MAX2371		-14	-10	
		MAX2373		-10	-6.5	
Reverse Isolation (S12)	Over AGC range	MAX2371		-40	-35	dB
		MAX2373		-42	-35	
Max Power Gain (Note 3)	LNA_I = high, T _A = +25°C, V _{CC} = 2.775V	MAX2371	13	14.5	16	dB
		MAX2373	14	15.5	17	
	LNA_I = low, T _A = +25°C, V _{CC} = 2.775V	MAX2371	10.5	12		
		MAX2373	10.5	13		
Gain Variation Over Temperature	T _A = -40°C to +85°C, V _{AGC} < 1.8V		-2.0		2.0	dB

LNAs with Step Attenuator and VGA

MAX2371/MAX2373

AC ELECTRICAL CHARACTERISTICS (continued)

(MAX2371/MAX2373 EV Kits, $V_{CC} = 2.65V$ to $3.3V$, $RX_EN = high$, $R_{SET} = 1.1k\Omega$, $T_A = -40^\circ C$ to $+85^\circ C$. Typical values are at $V_{CC} = 2.775V$; for MAX2371 $f_{RF} = 150MHz$, for MAX2373 $f_{RF} = 850MHz$ to $940MHz$; $T_A = +25^\circ C$, unless otherwise noted.) (Note 1)

PARAMETER	CONDITIONS		MIN	TYP	MAX	UNITS
SSB Noise Figure vs. AGC	LNA_I = high, $T_A = +25^\circ C$, $V_{CC} = 2.775V$, $RF_ATTN = low$	$V_{AGC} = 1.275V$		1.8	2.2	dB
		$V_{AGC} = 1.575V$		5.0	7.7	
		$V_{AGC} = 1.875V$		11	14.5	
		$V_{AGC} = 2.175V$		20		
	LNA_I = low, $T_A = +25^\circ C$, $V_{CC} = 2.775V$, $RF_ATTN = low$	$V_{AGC} = 1.275V$		2.1	2.6	
Input 1dB Compression Point	RF_ATTEN = low, $V_{AGC} < 1.8V$	LNA_I = high	-21.5	19.5	dBm	
		LNA_I = low	-24	-22		
	RF_ATTEN = high, $V_{AGC} < 1.8V$	LNA_I = high	-3	0		
		LNA_I = low	-9	-6.5		
Input IP3 (Notes 4, 5)	RF_ATTEN = low, $V_{AGC} = V_{CC}/2$	LNA_I = high	-5	-1	dBm	
		LNA_I = low	MAX2371	-7		-4
	MAX2373		-12	-9		
	RF_ATTEN = high, $V_{AGC} = V_{CC}/2$ to $2.575V$	LNA_I = high	9	13		
Input IP3 Over AGC Range	RF_ATTEN = low, LNA_I = high, $V_{AGC} = V_{CC}/2$ to $1.80V$	MAX2371	-10.5	-8	dBm	
		MAX2373	-12.5	-10.5		
AGC RESPONSE						
AGC Attenuation Range (Note 6)	$V_{CC} = 2.775V$, $RF_ATTN = low$, $V_{AGC} = 1.3375V$ to $2.575V$, $T_A = +25^\circ C$		35	45		dB
AGC Slope Over Control Range	RF_ATTEN = low, $V_{AGC} = 1.625V$		32	40	47	dB/V
	RF_ATTEN = high, $V_{AGC} = 1.625V$		24	33	41	
RF STEP ATTENUATOR						
Gain Step	RF_ATTEN = high to low, LNA_I = high	MAX2371	16.0	17.5	19.0	dB
		MAX2373	18.0	19.5	21.0	

Note 1: Parameters over temperature and supply voltage range are guaranteed by design and characterization, unless otherwise noted.

Note 2: Operation outside these frequency bands is possible but has not been characterized. See *Typical Operating Characteristics*.

Note 3: Measured with external matching network.

Note 4: $f_{IN1} = 150MHz$, $f_{IN2} = 150.1MHz$, $P_{IN} = -30dBm$ for both tones (MAX2371).

Note 5: $f_{IN1} = 900MHz$, $f_{IN2} = 900.1MHz$, $P_{IN} = -30dBm$ for both tones (MAX2373).

Note 6: Parameters are guaranteed by production test.

LNAs with Step Attenuator and VGA

Typical Operating Characteristics

(MAX2371/MAX2373 EV Kits, $V_{CC} = 2.775V$, $RX_EN = \text{high}$, $R_{SET} = 1.1k\Omega$, $LNA_I = \text{high}$, $T_A = +25^\circ C$. For MAX2371, $f_{RF} = 150MHz$; for MAX2373, $f_{RF} = 900MHz$, unless otherwise noted.)

MAX2371

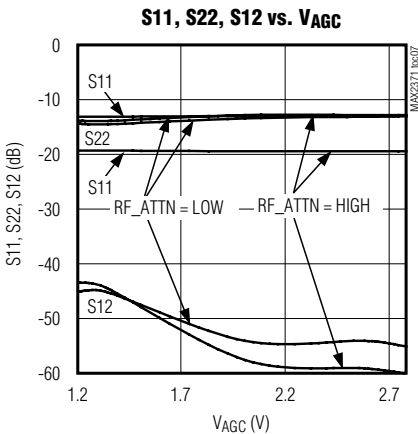
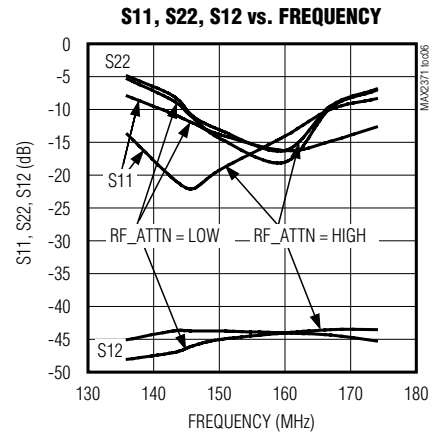
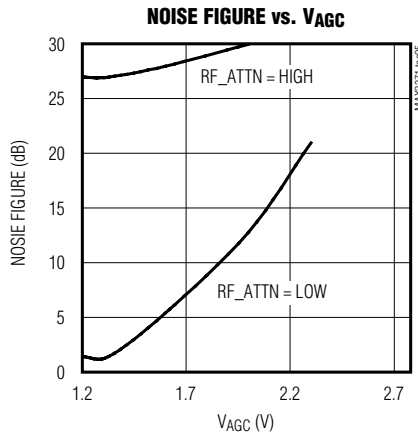
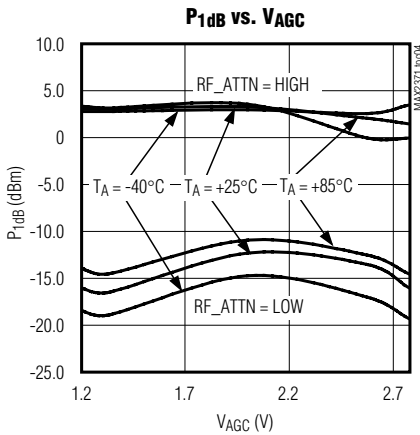
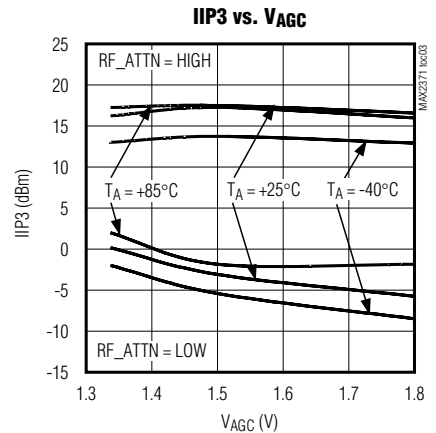
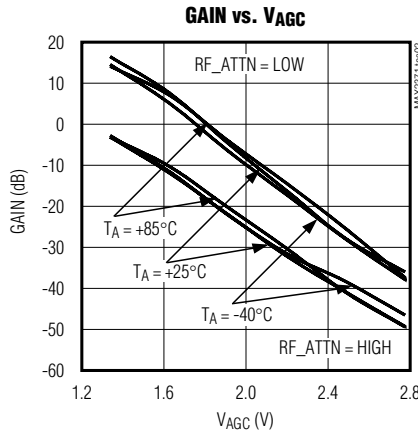
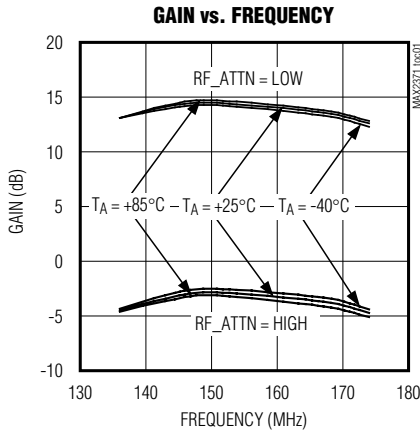

LNAs with Step Attenuator and VGA

Typical Operating Characteristics (continued)

(MAX2371/MAX2373 EV Kits, $V_{CC} = 2.775V$, $RX_EN = \text{high}$, $R_{SET} = 1.1k\Omega$, $LNA_I = \text{high}$, $T_A = +25^\circ C$. For MAX2371, $f_{RF} = 150MHz$; for MAX2373, $f_{RF} = 900MHz$, unless otherwise noted.)

MAX2373

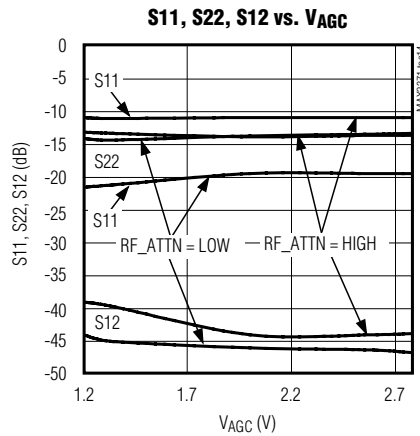
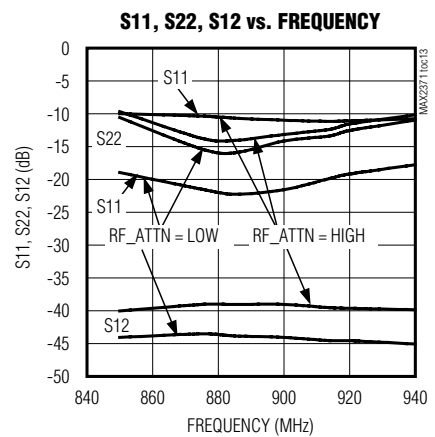
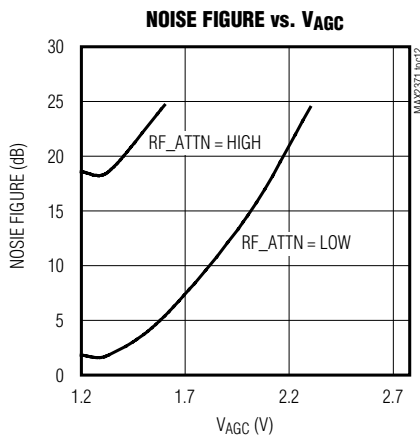
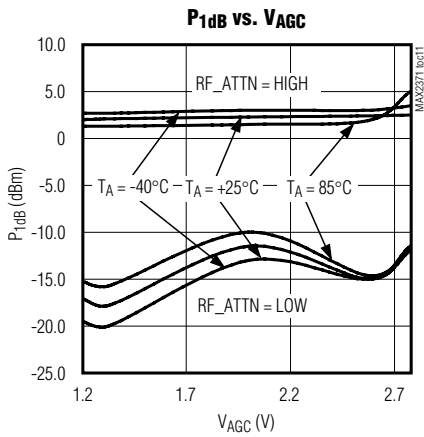
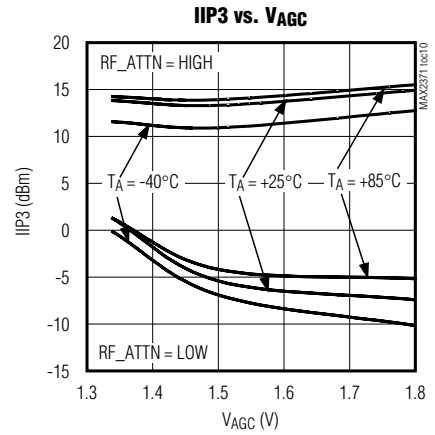
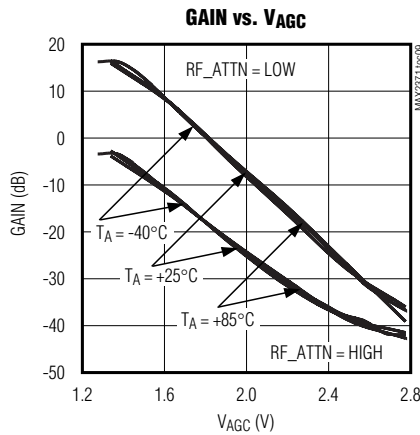
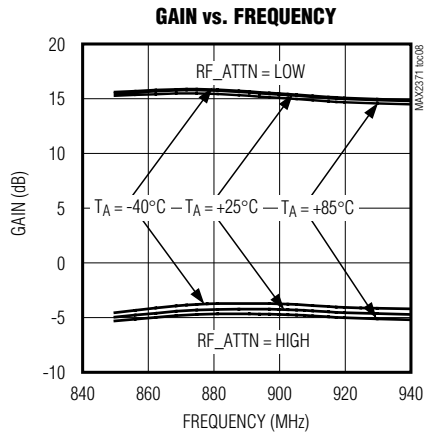

MAX2371/MAX2373

LNAs with Step Attenuator and VGA

MAX2371/MAX2373

Table 1. MAX2371 S-Parameters

(V_{CC} = 2.775V, RX_EN = high, LNA_I = high, RF_ATTN = low, P_{IN} = -30dBm, T_A = +25°C.)

FREQUENCY (MHz)	LNA (S11)		LNA (S21)		LNA (S12)		LNA (S22)	
	MAGNITUDE	PHASE	MAGNITUDE	PHASE	MAGNITUDE	PHASE	MAGNITUDE	PHASE
10	0.943409	-4.8477	5.980672	171.1200	0.002136	-102.490	0.998803	-1.1632
100	0.746965	-29.9420	2.959750	102.1900	0.002021	61.149	0.994752	-4.4481
150	0.728794	-35.6990	2.347308	89.6950	0.003089	138.790	0.985485	-6.0754
200	0.705066	-43.4190	1.769355	75.0130	0.003238	47.793	0.986870	-7.7399
300	0.704636	-55.1180	1.290313	58.1420	0.004439	83.493	0.979073	-11.1180
400	0.719615	-65.2420	1.060230	45.42700	0.003346	82.612	0.963130	-14.6680
500	0.731998	-73.5040	0.930754	36.0670	0.004395	68.614	0.947862	-18.0970
600	0.736258	-80.6450	0.849660	28.4990	0.006155	71.599	0.935998	-21.2670
700	0.738074	-85.6220	0.810047	22.7470	0.004143	56.224	0.930518	-23.5710
800	0.738465	-89.2240	0.796627	18.1080	0.005580	93.741	0.935158	-25.5640
900	0.736843	-91.6690	0.793643	14.3230	0.005309	89.871	0.933372	-27.8980
1000	0.720668	-94.0260	0.801946	9.9632	0.007592	99.418	0.941369	-30.2110
1100	0.712090	-96.1830	0.816554	5.9889	0.008451	122.090	0.940860	-32.2310
1200	0.690343	-98.0560	0.836893	1.1604	0.011955	129.220	0.936774	-34.6290
1300	0.657098	-100.3900	0.861113	-4.3698	0.014966	130.200	0.930219	-37.6190
1400	0.606583	-103.2500	0.891302	-10.2610	0.019602	131.440	0.925103	-40.1400
1500	0.545500	-106.6300	0.925092	-16.1910	0.023963	128.730	0.926670	-42.0800
1600	0.469143	-111.0400	0.966707	-23.1040	0.031521	121.710	0.939042	-43.7830
1700	0.372315	-116.0200	1.002767	-29.9130	0.039505	114.740	0.949456	-45.2980
1800	0.267147	-123.3900	1.021504	-37.6360	0.047321	109.530	0.966296	-46.5300
1900	0.150522	-137.6100	1.021081	-45.7240	0.056859	100.480	0.975001	-48.7600
2000	0.060478	160.4700	0.995004	-53.5490	0.063929	92.788	0.971740	-50.8360

LNAs with Step Attenuator and VGA

MAX2371/MAX2373

Table 2. MAX2373 S-Parameters

(V_{CC} = 2.775V, RX_EN = high, LNA_I = high, RF_ATTN = low, P_{IN} = -30dBm, T_A = +25°C.)

FREQUENCY (MHz)	LNA (S11)		LNA (S21)		LNA (S12)		LNA (S22)	
	MAGNITUDE	PHASE	MAGNITUDE	PHASE	MAGNITUDE	PHASE	MAGNITUDE	PHASE
10	0.952248	-0.8171	7.273610	-178.830	0.002162	-89.276	1.000092	-0.8184
100	0.933405	-9.1461	7.077013	163.940	0.001346	78.684	0.993482	-2.3140
200	0.884179	-16.6570	6.529802	150.770	0.002137	32.634	0.991791	-3.8136
300	0.824784	-22.6500	5.929253	139.770	0.002217	72.860	0.983762	-5.6360
400	0.767609	-27.4800	5.400078	130.020	0.001332	86.532	0.971102	-7.2455
500	0.709643	-30.9910	4.904559	121.750	0.001641	86.431	0.958562	-8.9841
600	0.656682	-34.5840	4.431492	113.750	0.002297	70.617	0.955972	-10.7250
700	0.616673	-37.2530	4.016983	107.480	0.001701	105.050	0.946259	-12.1890
800	0.586388	-39.7830	3.644182	101.820	0.002688	73.619	0.941846	-13.4650
900	0.558837	-41.8580	3.313218	97.239	0.001077	143.410	0.933168	-15.1090
1000	0.536056	-42.9140	3.059039	92.435	0.001617	102.100	0.938912	-16.8900
1100	0.524439	-44.4030	2.805078	87.484	0.001442	151.320	0.932492	-18.5160
1200	0.516220	-45.9560	2.614027	82.687	0.002973	178.790	0.926200	-20.8080
1300	0.511487	-47.1900	2.417436	78.482	0.003764	-175.540	0.919094	-23.6930
1400	0.508259	-47.9420	2.253642	74.093	0.004195	-176.470	0.919952	-25.7200
1500	0.504028	-49.1020	2.090210	70.061	0.007366	-163.150	0.917498	-27.9410
1600	0.509736	-50.1550	1.975627	66.443	0.008200	-162.620	0.919486	-29.8050
1700	0.510000	-51.3530	1.841259	63.336	0.010929	-163.870	0.923092	-32.1340
1800	0.513009	-52.9500	1.719293	59.870	0.015327	-160.350	0.924634	-33.9510
1900	0.515994	-54.6510	1.597405	56.385	0.016692	-162.560	0.933781	-36.3470
2000	0.510141	-55.6650	1.467185	53.411	0.018843	-177.660	0.933039	-38.8240

Table 3. MAX2371 Typical Noise Parameters

(V_{CC} = 2.775V, RX_EN = high, LNA_I = high, RF_ATTN = low, P_{IN} = -30dBm, T_A = +25°C, data from design simulation.)

FREQUENCY (MHz)	NF _{MIN} (dB)	Γ _{OPT}	∠Γ _{OPT}	R _N (Ω)
130	0.84	0.34	46.4	8.8
140	0.83	0.35	49.3	8.5
150	0.82	0.34	52.7	8.1
160	0.81	0.34	56.2	7.8
170	0.81	0.33	59.8	7.5
180	0.81	0.32	63.4	7.1

LNAs with Step Attenuator and VGA

Table 4. MAX2373 Typical Noise Parameters

($V_{CC} = 2.775V$, $RX_EN = \text{high}$, $LNA_I = \text{high}$, $RF_ATTN = \text{low}$, $P_{IN} = -30\text{dBm}$, $T_A = +25^\circ\text{C}$, data from design simulation.)

FREQUENCY (MHz)	NF _{MIN} (dB)	$ \Gamma_{OPT} $	$\angle \Gamma_{OPT}$	R _N (Ω)
850	1.06	0.35	60.5	10.02
870	1.08	0.35	61.8	9.98
890	1.10	0.34	63.3	9.94
910	1.11	0.34	64.7	9.90
930	1.13	0.33	66.2	9.86
950	1.15	0.33	67.7	9.82

Pin Description

PIN	NAME	FUNCTION
1	LNA_IN	RF Input. Requires DC-blocking capacitor and external matching network.
2	LNA_E	LNA Emitter. Connect to GND with an inductor. See inductor value in Table 5.
3	RX_EN	LNA Control. Set RX_EN high to enable LNA; set RX_EN low to disable LNA.
4	RF_ATTEN	Attenuator Control. Set RF_ATTEN high for low-gain mode; set RF_ATTEN low for high-gain mode.
5	AGC	AGC Input Voltage. Set AGC to $V_{CC}/2$ for maximum gain. Set AGC to $V_{CC} - 200\text{mV}$ for minimum gain. If left unconnected, the LNA will operate at maximum gain and optimum noise figure.
6	LNA_I	LNA Nominal Bias-Current Setting. Set LNA_I high for high-current mode. Set LNA_I low for low-current mode. If left unconnected, the default state of the LNA is high-current mode.
7	LNA_OUT	RF Output Pin. Requires a pullup inductor to LNA_V _{CC} and external matching network.
8	LNA_V _{CC}	Supply Voltage for the AGC Amplifier
9	AGC_BYP	AGC Bypass. Connect a capacitor to ground. The value of the capacitor is a compromise of AGC response time and blocker frequency offset.
10	RSET	External pin for precision resistor to ground to set reference bias current for IC; typical bias current is 50 μA to 100 μA .
11	RF_V _{CC}	Supply Voltage for the LNA. Bypass with a capacitor to GND as close to the pin as possible. Do NOT connect any tuned circuits to this supply pin.
12	GND	Ground
EP	Exposed Pad	Internally connected to GND. Connect to a large ground plane to maximize thermal performance. Do not use as the sole ground connection point.

Table 5. Inductor Selection

BAND	L SERIES VALUE (nH)	LNA TYPE
150MHz (VHF)	33	Low Band
450MHz (UHF)	10	Low Band
450MHz (UHF)	2.7	High Band
800MHz	2.5	High Band
1GHz	1.8	High Band

Detailed Description

The MAX2371/MAX2373 are single-channel, single-ended, low-noise amplifiers with two gain modes and continuous automatic gain control (AGC) in both modes. The devices are intended as low-noise gain

stages for direct conversion receivers (DCR) or very low IF (VLIF) receivers. These devices provide high gain-control dynamic range (typ 60dB) at RF with excellent noise and reverse isolation characteristics.

Vary the resistor at pin RSET and the inductor at LNA_E to meet a wide range of gain and linearity requirements. The ICs can be dynamically configured through pins LNA_I and RF_ATTEN. When LNA_I is connected to V_{CC}, the LNA is in high-current mode, nominally configured for maximum gain and low noise figure of the amplifier. If the LNA_I pin is grounded, the current of the LNA is reduced, and the associated gain, input IP₃, and noise figure are degraded. The devices have two gain modes configured by the RF_ATTEN pin. Set RF_ATTEN high for low-gain mode; set RF_ATTEN low for high-gain mode. The gain step between these two gain modes typically is 20dB.

LNAs with Step Attenuator and VGA

The MAX2371/MAX2373 can be turned off in transmit or battery-save standby mode. The receive-enable pin (RX_EN) also can turn off the devices even if V_{CC} is not removed, because multiple LNAs can be connected to the same V_{CC} for multiband applications.

The devices allow external matching networks to configure operation in a wide frequency range. Refer to the EV kit schematic for a guide to designing the matching network.

Applications Information

AGC

The AGC of the MAX2371/MAX2373 is controlled by an external voltage at pin AGC. The amplifier is at full gain if the voltage at pin AGC is nominally V_{CC}/2. It is at minimum gain if the voltage at pin AGC is V_{CC}. The AGC attenuation range, which is continuously variable, is specified at 45dB. The IP₃ will degrade slightly as AGC reduces the gain.

The devices include two gain modes. Set RF_ATT_N high to enable the low-gain mode, which reduces the gain by about 20dB. Low-gain mode will increase the system IP₃ by approximately 18dB, which provides strong signal overload and IM protection. An external pin (RF_ATT_N) controls switching between gain modes so this function can be combined with overall AGC control. AGC is independent of the choice of gain mode. The gain step between modes is in addition to the range of AGC, allowing a large overall gain-control range.

AGC Response

A linear transfer function between the AGC control signal and the AGC attenuation is realized in dB. The linear relationship in dB/V is maintained to ±10% over a specified attenuation range. Any compensation for gain-mode change must come from the AGC control. After reducing gain by switching the RF_ATT_N pin, reduce the AGC voltage to achieve the desired overall gain.

The LNA current also can be changed by toggling the LNA_I pin. This operation is independent of gain mode and AGC control. The low-current mode is intended as a second (reduced-current) quiescent point of operation for strong-signal operating environments.

Matching Networks

For best performance, match LNA_IN and LNA_OUT to 50Ω for the band of operation. Typical matching circuits for two bands (136MHz to 174MHz and 850MHz to 940MHz) are shown in the EV kit. The chip impedance changes minimally from low to high gain and with AGC. The input requires a DC-blocking capacitor. The size of this capacitor influences the startup time and IP₃. There is a trade-off between these: A large DC-blocking

capacitor means a good IP₃ and slow startup. The maximum startup time is determined by the equation below:

$$\text{MAXT}_{\text{START}} = 40 \times C_{\text{AC}} \times R_{\text{SET}}$$

where C_{AC} = AC-coupling cap in Farads, R_{SET} = current-setting resistor in Ω.

IP₃ will improve with the separation of the interfering tones, so a wider channel system can use a smaller DC-blocking capacitor and achieve a better IP₃. The customer also can change the emitter inductor at LNA_E to get the desired linearity and gain. Changing this inductor value requires a change to the input match. The output is an open collector and needs a pullup inductor. A load resistor also can be connected across it. The resistor determines the trade-off between the bandwidth of the match and the gain. A small load resistor means a wider match and lower gain.

Layout Issues

For best performance, pay attention to power-supply issues as well as to the layout of the RFO_{UT} matching network. The EV kit can be used as a layout example. Ground connections followed by supply bypass are the most important.

Power-Supply Bypassing

The MAX2371/MAX2373 have two supply pins: LNA_V_{CC} and RF_V_{CC}. These must be bypassed separately. It is assumed that there is a large capacitor decoupling the power supply. LNA_V_{CC} and RF_V_{CC} are each decoupled with 1500pF (MAX2371) or 100pF (MAX2373) capacitor. Use separate paths to the ground plane for each of the bypass capacitors, and minimize trace length to reduce inductance. The exposed pad must be connected to system ground with very low impedance vias.

Power-Supply Layout

To minimize coupling between sections of the IC, the ideal power-supply layout is a star configuration with a large decoupling capacitor at a central V_{CC} node. The V_{CC} traces branch from this central node, each to a separate V_{CC} node in the PC board. At the end of each trace is a bypass capacitor that has low ESR at the RF of operation. This arrangement provides local decoupling at each V_{CC} pin. At high frequencies, any signal leaking out of one supply pin sees a relatively high impedance (formed by the V_{CC} trace inductance) to the central V_{CC} node and an even higher impedance to any other supply pin, as well as a low impedance to ground through the bypass capacitor.

LNAs with Step Attenuator and VGA

Typical Operating Circuits

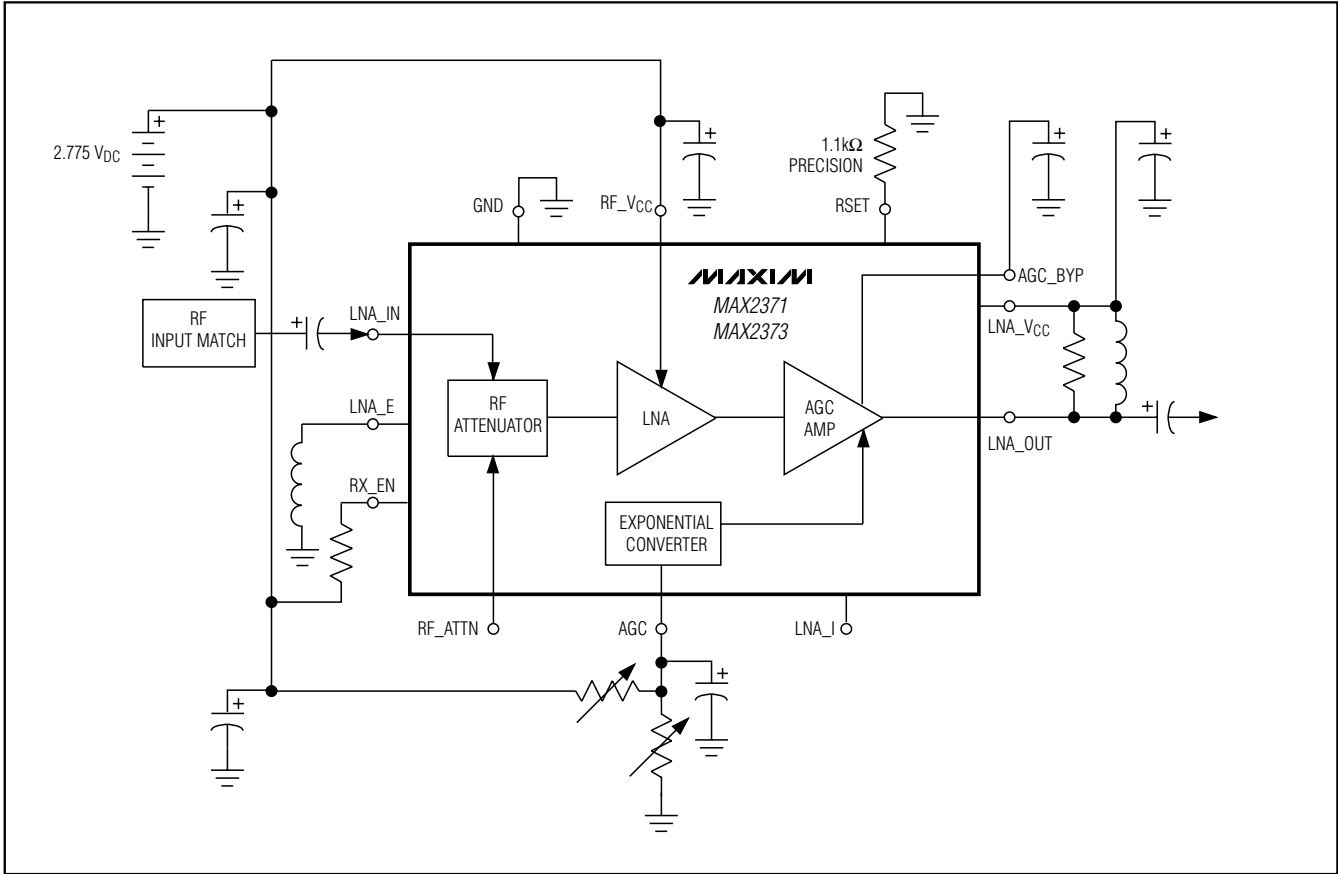

Impedance-Matching Network Layout

The input- and output-matching networks are sensitive to layout-related parasitic inductions. To minimize parasitic inductance, keep traces short and place components as close as possible to the chip. To minimize parasitic capacitance, minimize the area of the plane.

Chip Information

TRANSISTOR COUNT: 360

Revision History

Pages changed at Rev 1: 1, 8, 10

Maxim cannot assume responsibility for use of any circuitry other than circuitry entirely embodied in a Maxim product. No circuit patent licenses are implied. Maxim reserves the right to change the circuitry and specifications without notice at any time.

Maxim Integrated Products, 120 San Gabriel Drive, Sunnyvale, CA 94086 408-737-7600

© 2006 Maxim Integrated Products

MAXIM is a registered trademark of Maxim Integrated Products, Inc.