

High-Dynamic-Range, Direct Upconversion 1500MHz to 2500MHz Quadrature Modulator

General Description

The MAX2022 low-noise, high-linearity, direct upconversion quadrature modulator is designed for single and multicarrier 1800MHz to 2200MHz UMTS/WCDMA, cdma2000®, and DCS/PCS base-station applications. Direct upconversion architectures are advantageous since they significantly reduce transmitter cost, part count, and power consumption as compared to traditional IF-based double upconversion systems.

In addition to offering excellent linearity and noise performance, the MAX2022 also yields a high level of component integration. This device includes two matched passive mixers for modulating in-phase and quadrature signals, three LO mixer amplifier drivers, and an LO quadrature splitter. On-chip baluns are also integrated to allow for single-ended RF and LO connections. As an added feature, the baseband inputs have been matched to allow for direct interfacing to the transmit DAC, thereby eliminating the need for costly I/Q buffer amplifiers.

The MAX2022 operates from a single +5V supply. It is available in a compact 36-pin thin QFN package (6mm x 6mm) with an exposed paddle. Electrical performance is guaranteed over the extended -40°C to +85°C temperature range.

Applications

Single and Multicarrier WCDMA/UMTS Base Stations
 Single and Multicarrier cdmaOne™ and cdma2000 Base Stations
 Single and Multicarrier DCS 1800/PCS 1900 EDGE Base Stations
 PHS/PAS Base Stations
 Predistortion Transmitters
 Fixed Broadband Wireless Access
 Wireless Local Loop
 Private Mobile Radio
 Military Systems
 Microwave Links
 Digital and Spread-Spectrum Communication Systems

cdma2000 is a registered trademark of Telecommunications Industry Association.

cdmaOne is a trademark of CDMA Development Group.

Features

- ◆ 1500MHz to 2500MHz RF Frequency Range
- ◆ Meets Four-Carrier WCDMA 65dBc ACLR
- ◆ +23.3dBm Typical OIP3
- ◆ +51.5dBm Typical OIP2
- ◆ 45.7dBc Typical Sideband Suppression
- ◆ -40dBm Typical LO Leakage
- ◆ -173.2dBm/Hz Typical Output Noise, Eliminating the Need for an RF Output Filter
- ◆ Broadband Baseband Input
- ◆ DC-Coupled Input Provides for Direct Launch DAC Interface, Eliminating the Need for Costly I/Q Buffer Amplifiers

Ordering Information

PART	TEMP RANGE	PIN-PACKAGE	PKG CODE
MAX2022ETX	-40°C to +85°C	36 Thin QFN-EP* (6mm x 6mm)	T3666-2
MAX2022ETX-T	-40°C to +85°C	36 Thin QFN-EP* (6mm x 6mm)	T3666-2
MAX2022ETX+D	-40°C to +85°C	36 Thin QFN-EP* (6mm x 6mm)	T3666-2
MAX2022ETX+TD	-40°C to +85°C	36 Thin QFN-EP* (6mm x 6mm)	T3666-2

*EP = Exposed paddle. + = Lead free. D = Dry pack.
 -T = Tape-and-reel package.

WCDMA, ACLR, ALTCLR and Noise vs. RF Output Power at 2140MHz for Single, Two, and Four Carriers

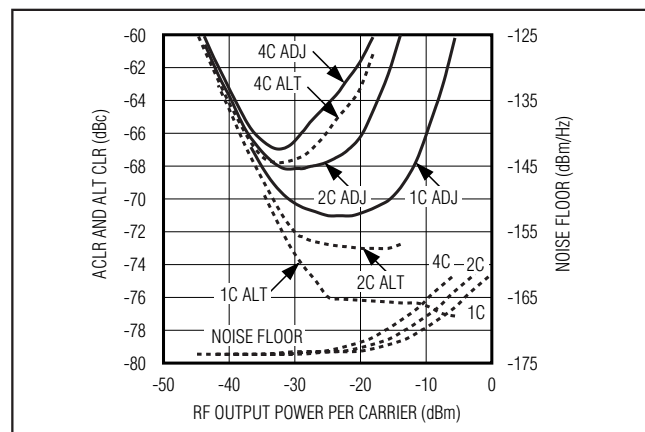

High-Dynamic-Range, Direct Upconversion 1500MHz to 2500MHz Quadrature Modulator

ABSOLUTE MAXIMUM RATINGS

VCC_ to GND	-0.3V to +5.5V
COMP	0 to VCC
BBIP, BBIN, BBQP, BBQN to GND	-2.5V to (VCC + 0.3V)
LO, RFOUT to GND Maximum Current	50mA
Baseband Differential I/Q Input Power (Note A)	+20dBm
LO Input Power	+10dBm
RBIASLO1 Maximum Current	10mA
RBIASLO2 Maximum Current	10mA
RBIASLO3 Maximum Current	10mA

θ_{JA} (without air flow)	34°C/W
θ_{JA} (2.5m/s air flow)	28°C/W
θ_{JC} (junction to exposed paddle)	8.5°C/W
Junction Temperature	+150°C
Storage Temperature Range	-65°C to +150°C
Lead Temperature (soldering 10s, non-lead free)	+245°C
Lead Temperature (soldering 10s, lead free)	+260°C

Note A: Maximum reliable continuous power applied to the baseband differential port is +12dBm from an external 100 Ω source.

Stresses beyond those listed under "Absolute Maximum Ratings" may cause permanent damage to the device. These are stress ratings only, and functional operation of the device at these or any other conditions beyond those indicated in the operational sections of the specifications is not implied. Exposure to absolute maximum rating conditions for extended periods may affect device reliability.

DC ELECTRICAL CHARACTERISTICS

(MAX2022 Typical Application Circuit, VCC = +4.75V to +5.25V, GND = 0V, I/Q inputs terminated into 100 Ω differential, LO input terminated into 50 Ω , RF output terminated into 50 Ω , R1 = 432 Ω , R2 = 562 Ω , R3 = 301 Ω , TC = -40°C to +85°C, unless otherwise noted. Typical values are at VCC = +5V, TC = +25°C, unless otherwise noted.) (Note 1)

PARAMETER	SYMBOL	CONDITIONS	MIN	TYP	MAX	UNITS
Supply Voltage	VCC		4.75	5.00	5.25	V
Total Supply Current	ITOTAL	Pins 3, 13, 15, 31, 33 all connected to VCC		292	342	mA
Total Power Dissipation				1460	1796	mW

AC ELECTRICAL CHARACTERISTICS

(MAX2022 Typical Application Circuit, VCC = +4.75V to +5.25V, GND = 0V, I/Q differential inputs driven from a 100 Ω DC-coupled source, 0V common-mode input, PLO = 0dBm, 1900MHz \leq fLO \leq 2200MHz, 50 Ω LO and RF system impedance, R1 = 432 Ω , R2 = 562 Ω , R3 = 301 Ω , TC = -40°C to +85°C. Typical values are at VCC = +5V, VBB1 = 109mVp-p differential, VBBQ = 109mVp-p differential, fIQ = 1MHz, TC = +25°C, unless otherwise noted.) (Note 1)

PARAMETER	SYMBOL	CONDITIONS	MIN	TYP	MAX	UNITS
BASEBAND INPUT						
Baseband Input Differential Impedance		fIQ = 1MHz		43		Ω
BB Common-Mode Input Voltage Range			-2.5	0	+1.5	V
Output Power		TC = +25°C	-24			dBm
RF OUTPUTS (fLO = 1960MHz)						
Output IP3		VBB1, VBBQ = 547mVp-p differential per tone into 50 Ω , fBB1 = 1.8MHz, fBB2 = 1.9MHz		21.8		dBm
Output IP2		VBB1, VBBQ = 547mVp-p differential per tone into 50 Ω , fBB1 = 1.8MHz, fBB2 = 1.9MHz		48.9		dBm
Output Power			-20.5			dBm

High-Dynamic-Range, Direct Upconversion 1500MHz to 2500MHz Quadrature Modulator

MAX2022

AC ELECTRICAL CHARACTERISTICS (continued)

(MAX2022 Typical Application Circuit, $V_{CC} = +4.75V$ to $+5.25V$, $GND = 0V$, I/Q differential inputs driven from a 100Ω DC-coupled source, $0V$ common-mode input, $P_{LO} = 0dBm$, $1900MHz \leq f_{LO} \leq 2200MHz$, 50Ω LO and RF system impedance, $R1 = 432\Omega$, $R2 = 562\Omega$, $R3 = 301\Omega$, $T_C = -40^\circ C$ to $+85^\circ C$. Typical values are at $V_{CC} = +5V$, $V_{BBI} = 109mV_{P-P}$ differential, $V_{BBQ} = 109mV_{P-P}$ differential, $f_{IQ} = 1MHz$, $T_C = +25^\circ C$, unless otherwise noted.) (Note 1)

PARAMETER	SYMBOL	CONDITIONS	MIN	TYP	MAX	UNITS
Output Power Variation Over Temperature		$T_C = -40^\circ C$ to $+85^\circ C$		-0.004		dB/ $^\circ C$
Output-Power Flatness		$f_{LO} = 1960MHz$, sweep f_{BB} , P_{RF} flatness for f_{BB} from 1MHz to 50MHz		0.6		dB
ACLR (1st Adjacent Channel 5MHz Offset)		Single-carrier WCDMA (Note 2), $RFOUT = -16dBm$		70		dBc
LO Leakage		No external calibration, with each baseband input terminated in 50Ω		-46.7		dBm
Sideband Suppression		No external calibration		47.3		dBc
Output Return Loss				15.3		dB
Output Noise Density		$f_{meas} = 2060MHz$, with each baseband input terminated in 50Ω		-173.4		dBm/Hz
LO Input Return Loss				10.1		dB
RF OUTPUTS ($f_{LO} = 2140MHz$)						
Output IP3		$V_{BBI}, V_{BBQ} = 547mV_{P-P}$ differential per tone into 50Ω , $f_{BB1} = 1.8MHz$, $f_{BB2} = 1.9MHz$		23.3		dBm
Output IP2		$V_{BBI}, V_{BBQ} = 547mV_{P-P}$ differential per tone into 50Ω , $f_{BB1} = 1.8MHz$, $f_{BB2} = 1.9MHz$		51.5		dBm
Output Power				-20.8		dBm
Output Power Variation Over Temperature		$T_C = -40^\circ C$ to $+85^\circ C$		-0.005		dB/ $^\circ C$
Output-Power Flatness		$f_{LO} = 2140MHz$, sweep f_{BB} , P_{RF} flatness for f_{BB} from 1MHz to 50MHz		0.32		dB
ACLR (1st Adjacent Channel 5MHz Offset)		Single-carrier WCDMA (Note 2), $RFOUT = -16dBm$, $f_{LO} = 2GHz$		70		dBc
LO Leakage		No external calibration, with each baseband input terminated in 50Ω		-40.4		dBm
Sideband Suppression		No external calibration		45.7		dBc
Output Return Loss				13.5		dB
Output Noise Density		$f_{meas} = 2240MHz$, with each baseband input terminated in 50Ω		-173.2		dBm/Hz
LO Input Return Loss				18.1		dB

Note 1: T_C is the temperature on the exposed paddle.

Note 2: Single-carrier WCDMA peak-to-average ratio of 10.5dB for 0.1% complimentary cumulative distribution function.

High-Dynamic-Range, Direct Upconversion 1500MHz to 2500MHz Quadrature Modulator

Typical Operating Characteristics

(MAX2022 Typical Application Circuit, 50Ω LO input, R1 = 432Ω, R2 = 562Ω, R3 = 301Ω, V_{CC} = +5V, P_{LO} = 0dBm, V_{I_{FI}} = V_{I_{FQ}} = 109mV_{p-p} differential, f_{IQ} = 1MHz, I/Q differential inputs driven from a 100Ω DC-coupled source, common-mode input from 0V, T_C = +25°C, unless otherwise noted.)

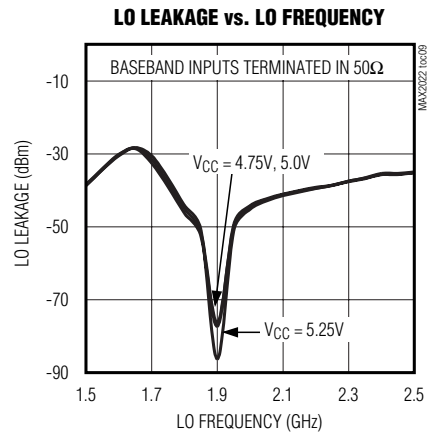
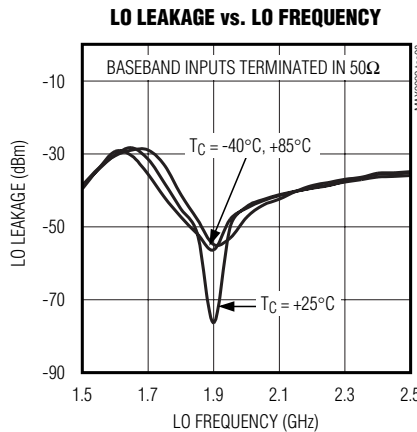
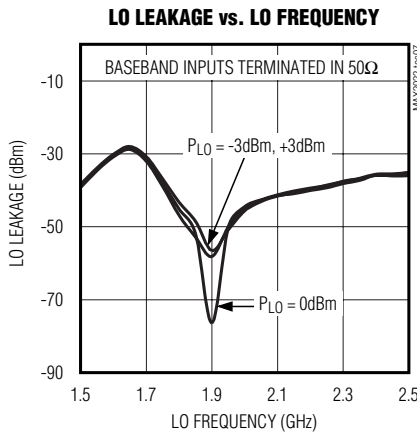
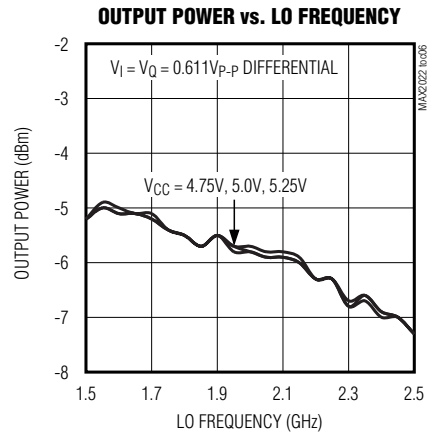
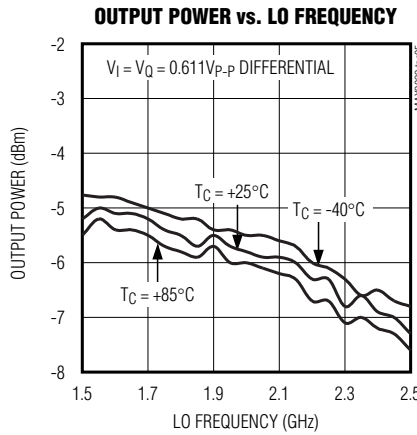
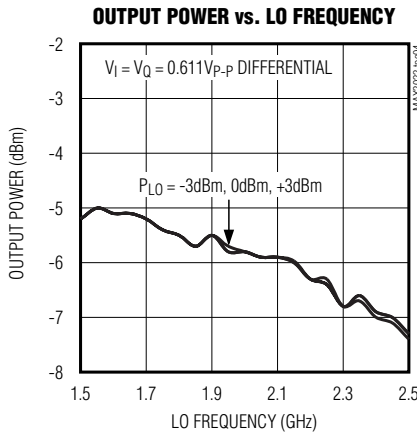
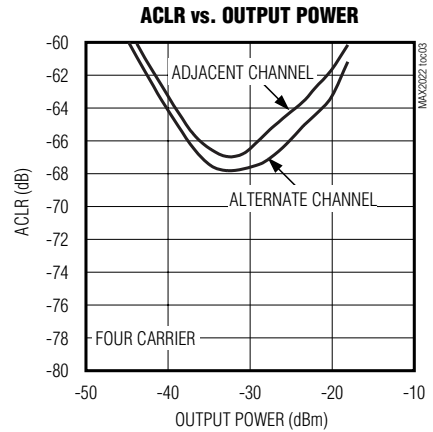
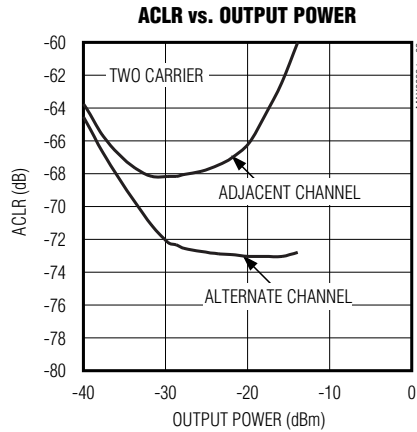
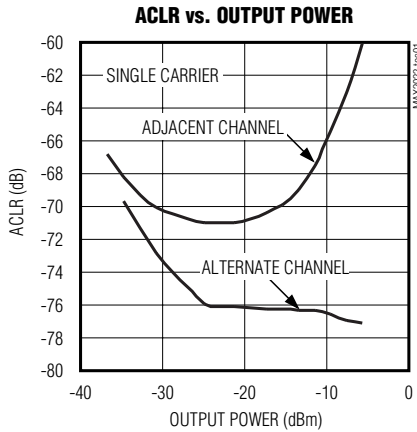

High-Dynamic-Range, Direct Upconversion 1500MHz to 2500MHz Quadrature Modulator

MAX2022

Typical Operating Characteristics (continued)

(MAX2022 Typical Application Circuit, 50Ω LO input, R1 = 432Ω, R2 = 562Ω, R3 = 301Ω, V_{CC} = +5V, P_{LO} = 0dBm, V_{IFI} = V_{IFQ} = 109mV_{p-p} differential, f_{IQ} = 1MHz, I/Q differential inputs driven from a 100Ω DC-coupled source, common-mode input from 0V, T_C = +25°C, unless otherwise noted.)

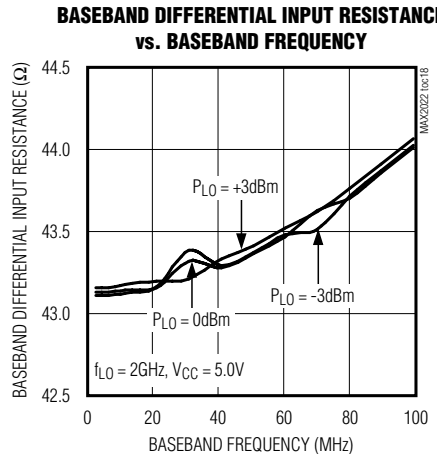
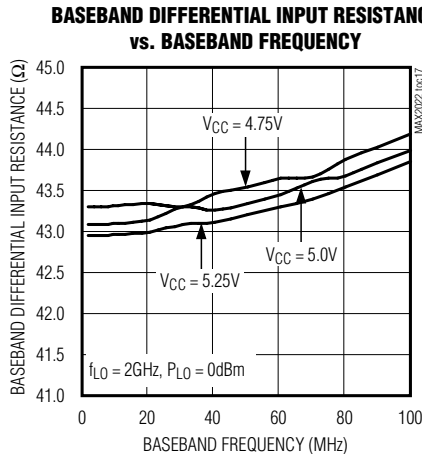
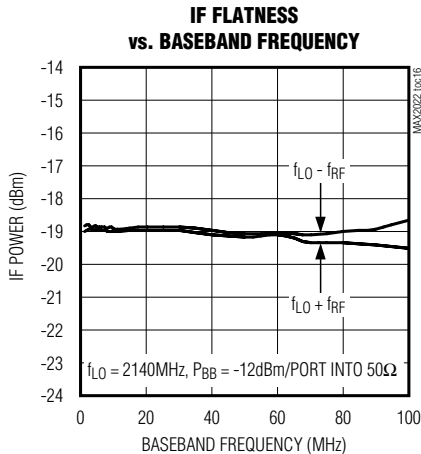
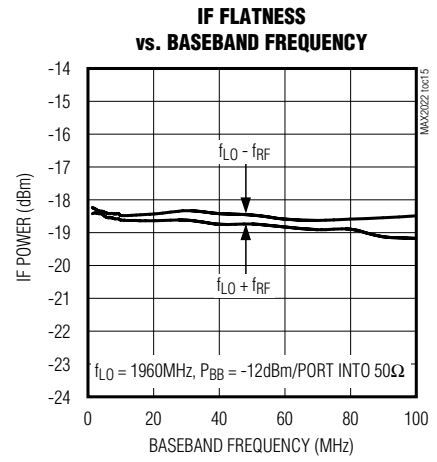
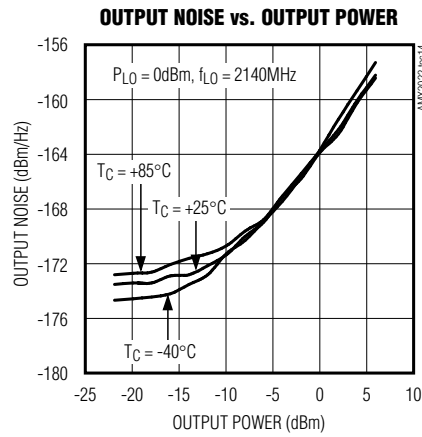
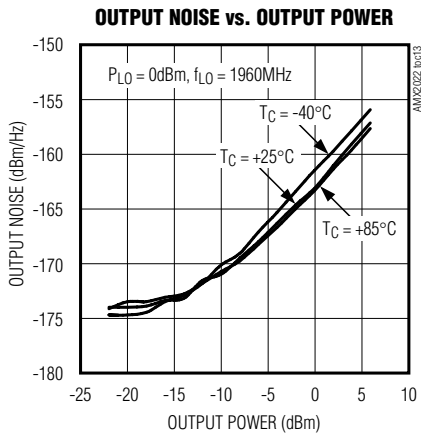
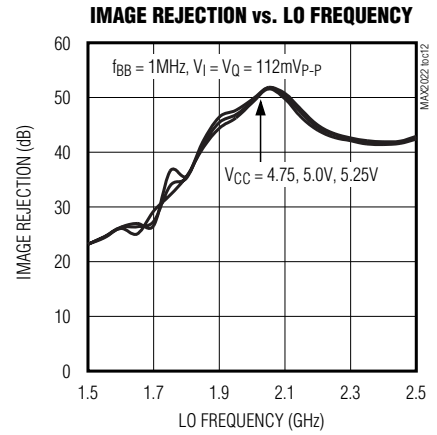
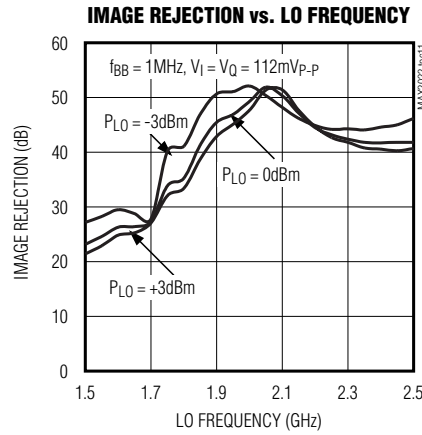
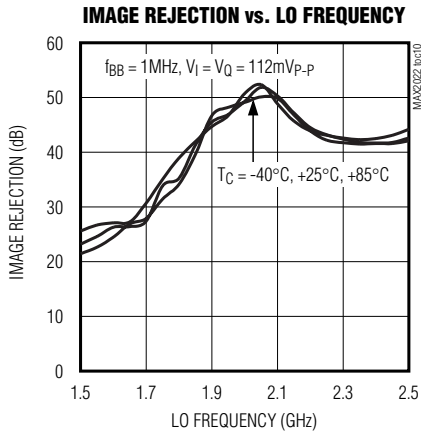

High-Dynamic-Range, Direct Upconversion 1500MHz to 2500MHz Quadrature Modulator

Typical Operating Characteristics (continued)

(MAX2022 Typical Application Circuit, 50Ω LO input, R1 = 432Ω, R2 = 562Ω, R3 = 301Ω, VCC = +5V, PLO = 0dBm, VIFI = VIFQ = 109mVp-p differential, fIQ = 1MHz, I/Q differential inputs driven from a 100Ω DC-coupled source, common-mode input from 0V, TC = +25°C, unless otherwise noted.)

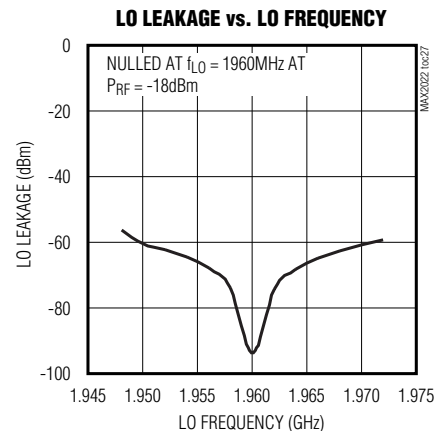
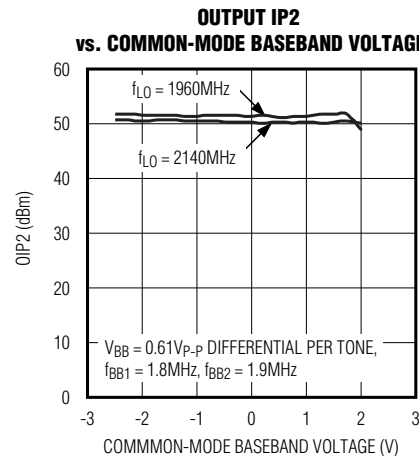
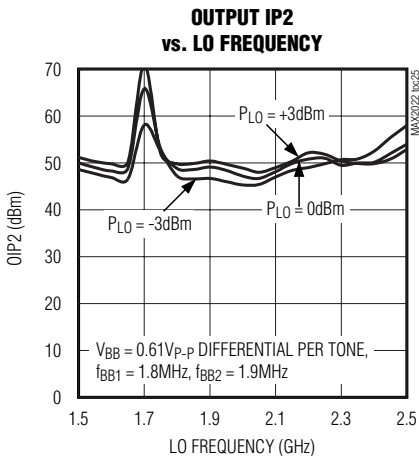
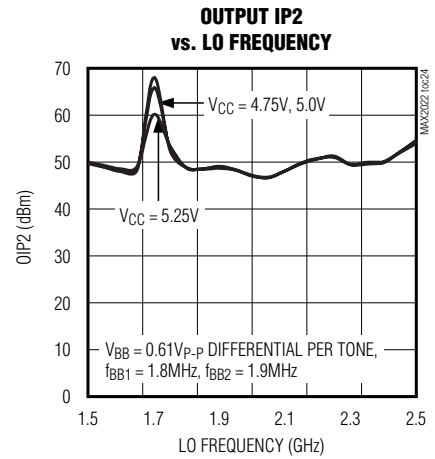
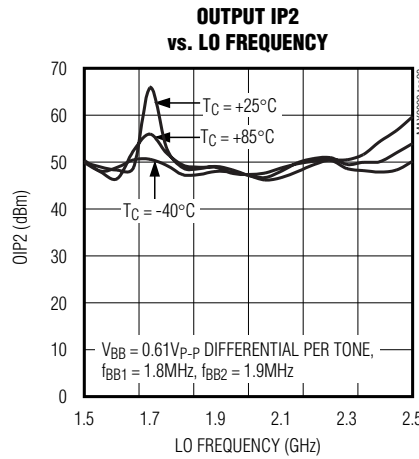
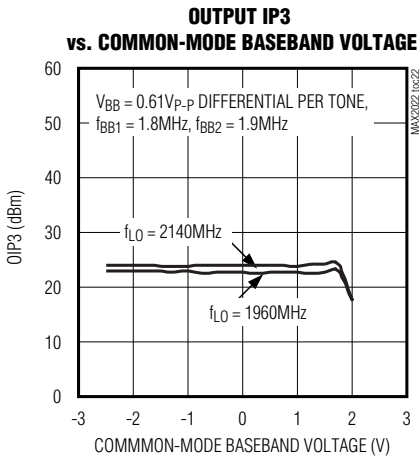
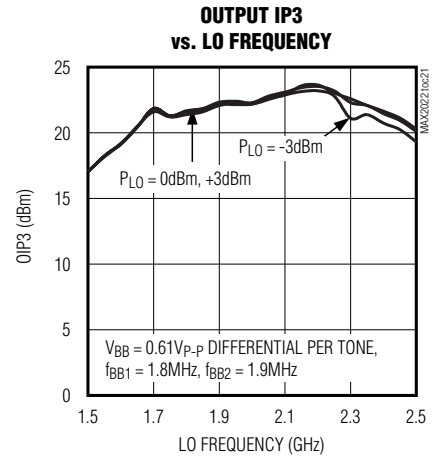
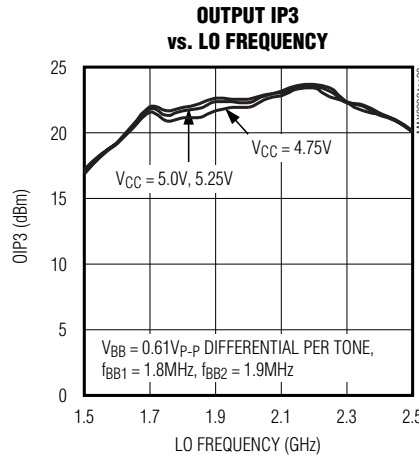
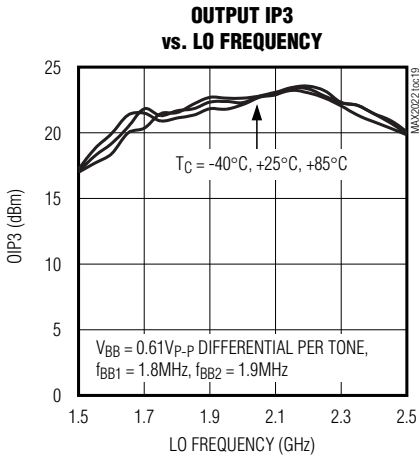

High-Dynamic-Range, Direct Upconversion 1500MHz to 2500MHz Quadrature Modulator

MAX2022

Typical Operating Characteristics (continued)

(MAX2022 Typical Application Circuit, 50Ω LO input, R1 = 432Ω, R2 = 562Ω, R3 = 301Ω, VCC = +5V, PLO = 0dBm, VIFI = VIFQ = 109mVp-p differential, fIQ = 1MHz, I/Q differential inputs driven from a 100Ω DC-coupled source, common-mode input from 0V, TC = +25°C, unless otherwise noted.)

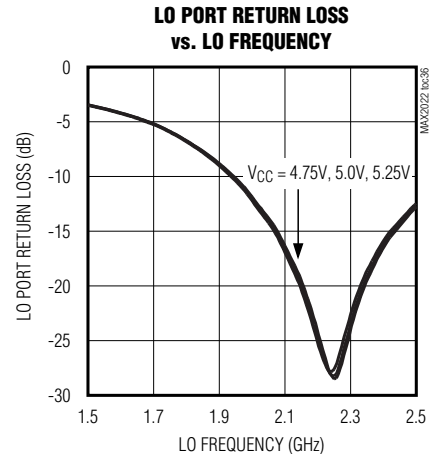
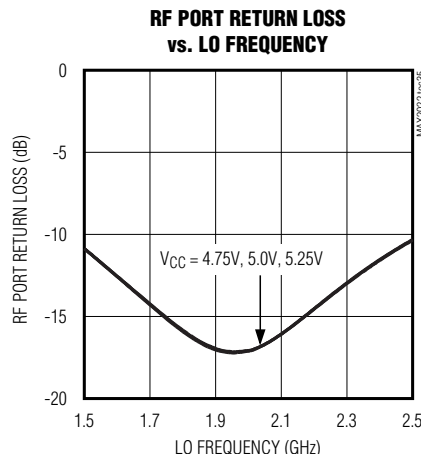
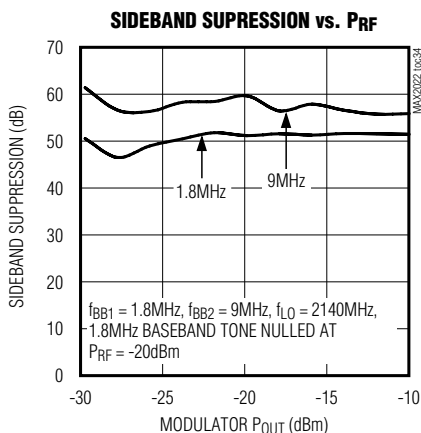
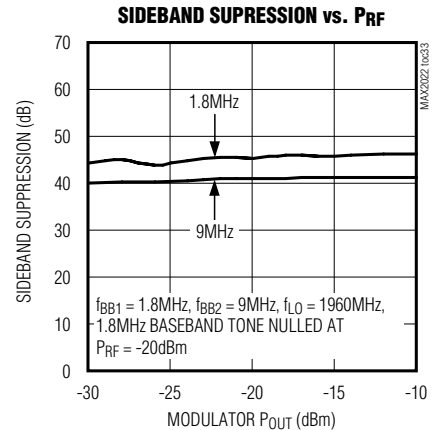
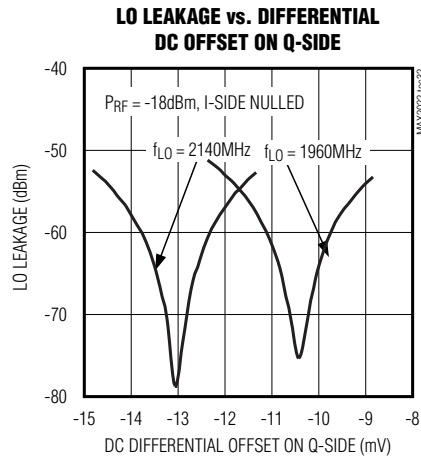
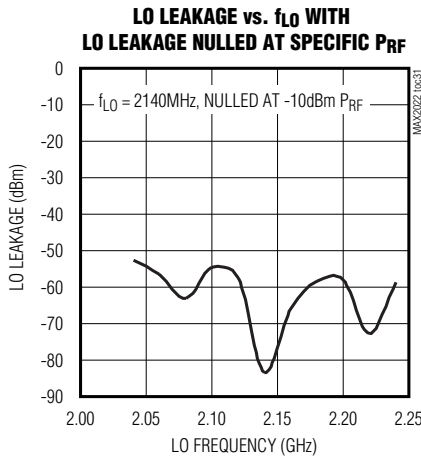
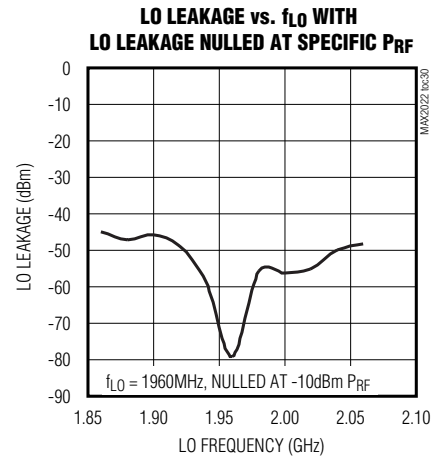
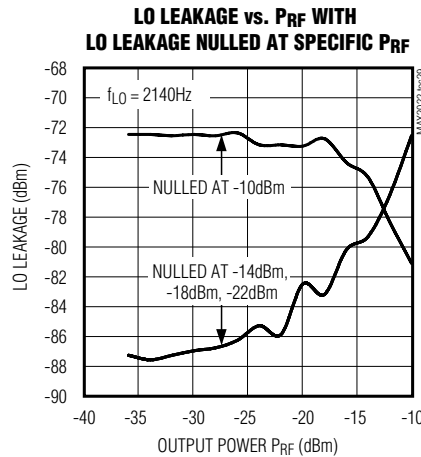
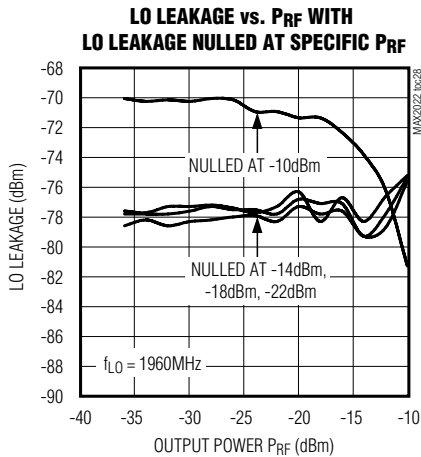

High-Dynamic-Range, Direct Upconversion 1500MHz to 2500MHz Quadrature Modulator

Typical Operating Characteristics (continued)

(MAX2022 Typical Application Circuit, 50Ω LO input, R1 = 432Ω, R2 = 562Ω, R3 = 301Ω, VCC = +5V, PLO = 0dBm, VIFI = VIFQ = 109mVp-p differential, fIQ = 1MHz, I/Q differential inputs driven from a 100Ω DC-coupled source, common-mode input from 0V, TC = +25°C, unless otherwise noted.)

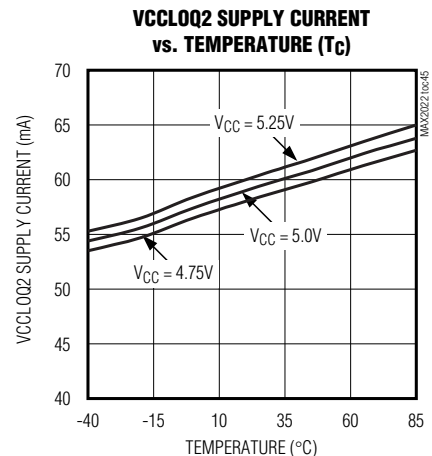
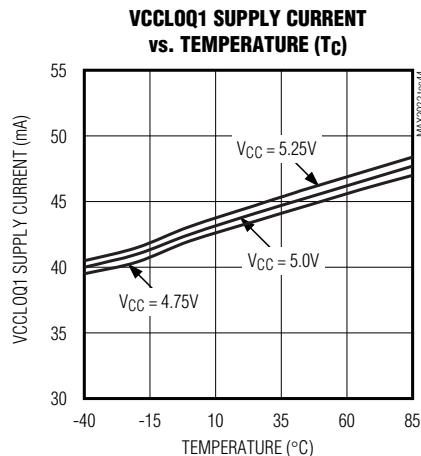
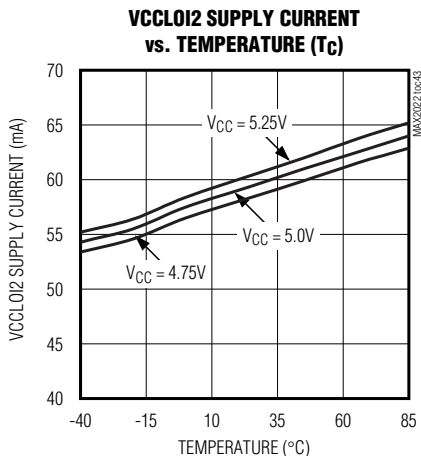
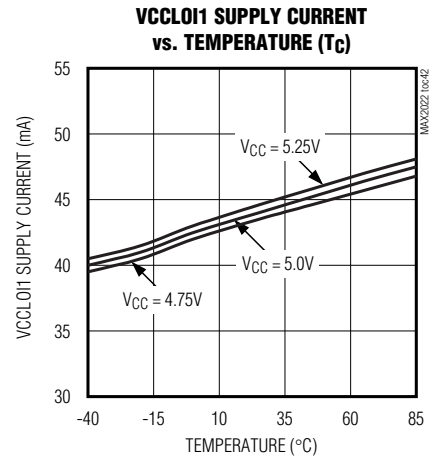
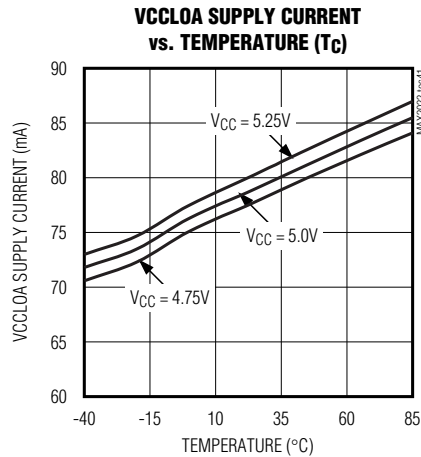
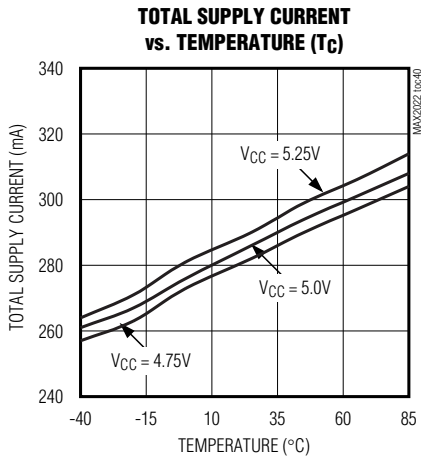
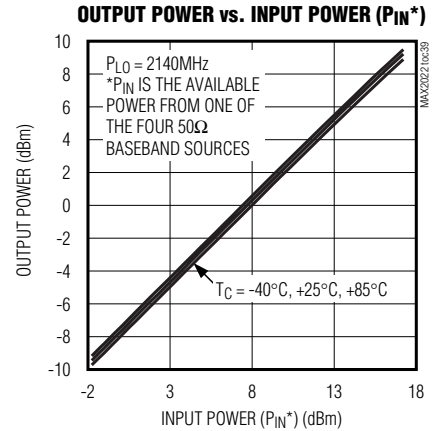
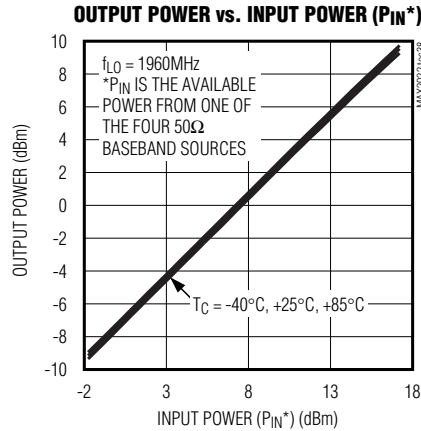
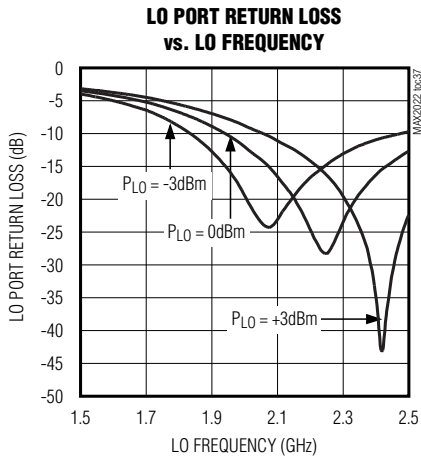

High-Dynamic-Range, Direct Upconversion 1500MHz to 2500MHz Quadrature Modulator

Pin Description

MAX2022

PIN	NAME	FUNCTION
1, 5, 9–12, 14, 16–19, 22, 24, 27–30, 32, 34, 35, 36	GND	Ground
2	RBIASLO3	3rd LO Amplifier Bias. Connect a 301 Ω resistor to ground.
3	VCCLOA	LO Input Buffer Amplifier Supply Voltage
4	LO	Local Oscillator Input. 50 Ω input impedance.
6	RBIASLO1	1st LO Input Buffer Amplifier Bias. Connect a 432 Ω resistor to ground.
7	COMP	Compensation Capacitor Input. Connect a 22pF capacitor to ground.
8	RBIASLO2	2nd LO Amplifier Bias. Connect a 562 Ω resistor to ground.
13	VCCLOI1	I-Channel 1st LO Amplifier Supply Voltage
15	VCCLOI2	I-Channel 2nd LO Amplifier Supply Voltage
20	BBIP	Baseband In-Phase Positive Input
21	BBIN	Baseband In-Phase Negative Input
23	RFOUT	RF Output
25	BBQN	Baseband Quadrature Negative Input
26	BBQP	Baseband Quadrature Positive Input
31	VCCLOQ2	Q-Channel 1st LO Amplifier Supply Voltage
33	VCCLOQ1	Q-Channel 2nd LO Amplifier Supply Voltage
EP	GND	Exposed Ground Paddle. The exposed paddle MUST be soldered to the ground plane using multiple vias.

Detailed Description

The MAX2022 is designed for upconverting differential in-phase (I) and quadrature (Q) inputs from baseband to a 1500MHz to 2500MHz RF frequency range. Applications include single and multicarrier 1800MHz to 2200MHz UMTS/WCDMA, cdma2000, and DCS/PCS base stations. Direct upconversion architectures are advantageous since they significantly reduce transmitter cost, part count, and power consumption as compared to traditional IF-based double upconversion systems.

The MAX2022 integrates internal baluns, an LO buffer, a phase splitter, two LO driver amplifiers, two matched double-balanced passive mixers, and a wideband quadrature combiner. Precision matching between the in-phase and quadrature channels, and highly linear mixers achieves excellent dynamic range, ACLR, 1dB compression point, and LO and sideband suppression, making it ideal for four-carrier WCDMA/UMTS operation.

LO Input Balun, LO Buffer, and Phase Splitter

The MAX2022 requires a single-ended LO input, with a nominal power of 0dBm. An internal low-loss balun at

the LO input converts the single-ended LO signal to a differential signal at the LO buffer input. In addition, the internal balun matches the buffer's input impedance to 50 Ω over the entire band of operation.

The output of the LO buffer goes through a phase splitter, which generates a second LO signal that is shifted by 90° with respect to the original. The 0° and 90° LO signals drive the I and Q mixers, respectively.

LO Driver

Following the phase splitter, the 0° and 90° LO signals are each amplified by a two-stage amplifier to drive the I and Q mixers. The amplifier boosts the level of the LO signals to compensate for any changes in LO drive levels. The two-stage LO amplifier allows a wide input power range for the LO drive. While a nominal LO power of 0dBm is specified, the MAX2022 can tolerate LO level swings from -3dBm to +3dBm.

I/Q Modulator

The MAX2022 modulator is composed of a pair of matched double-balanced passive mixers and a balun. The I and Q differential baseband inputs accept signals from DC to beyond 100MHz with differential amplitudes

High-Dynamic-Range, Direct Upconversion 1500MHz to 2500MHz Quadrature Modulator

up to 2V_{p-p} differential (common-mode input equals 0V). The wide input bandwidth allows for direct interface with the baseband DACs. No active buffer circuitry between the baseband DAC and the MAX2022 is required.

The I and Q signals directly modulate the 0° and 90° LO signals and are upconverted to the RF frequency. The outputs of the I and Q mixers are combined through a balun to a singled-ended RF output.

Applications Information

LO Input Drive

The LO input of the MAX2022 requires a single-ended drive at a 1500MHz to 2500MHz frequency. It is internally matched to 50Ω. An integrated balun converts the singled-ended input signal to a differential signal at the LO buffer differential input. An external DC-blocking capacitor is the only external part required at this interface. The LO input power should be within the -3dBm to +3dBm range.

COMP Pin

The COMP pin is used to provide additional lowpass filtering to the bias circuit noise. An external capacitor can be used from the COMP pin to ground to reduce the close-in noise of the modulator. For UMTS, connecting a 22pF capacitor from the COMP pin to ground is recommended to filter out noise and frequency offsets

above 3.5MHz. For GSM, connecting a 1nF capacitor from COMP to ground is recommended for filtering out noise and frequency offsets above 600kHz.

Baseband I/Q Input Drive

The MAX2022 I and Q baseband inputs should be driven differentially for best performance. The baseband inputs have a 50Ω differential input impedance. The optimum source impedance for the I and Q inputs is 100Ω differential. This source impedance will achieve the optimal signal transfer to the I and Q inputs, and the optimum output RF impedance match. The MAX2022 can accept input power levels of up to +12dBm on the I and Q inputs. Operation with complex waveforms, such as CDMA or WCDMA carriers, utilize input power levels that are far lower. This lower power operation is made necessary by the high peak-to-average ratios of these complex waveforms. The peak signals must be kept below the compression level of the MAX2022. The input common-mode voltage should be confined to the -2V to +1.5V DC range.

The MAX2022 is designed to interface directly with Maxim high-speed DACs. This generates an ideal total transmitter lineup, with minimal ancillary circuit elements. Such DACs include the MAX5875 series of dual DACs, and the MAX5895 dual interpolating DAC. These DACs have ground-referenced differential current outputs. Typical termination of each DAC output into a 50Ω load

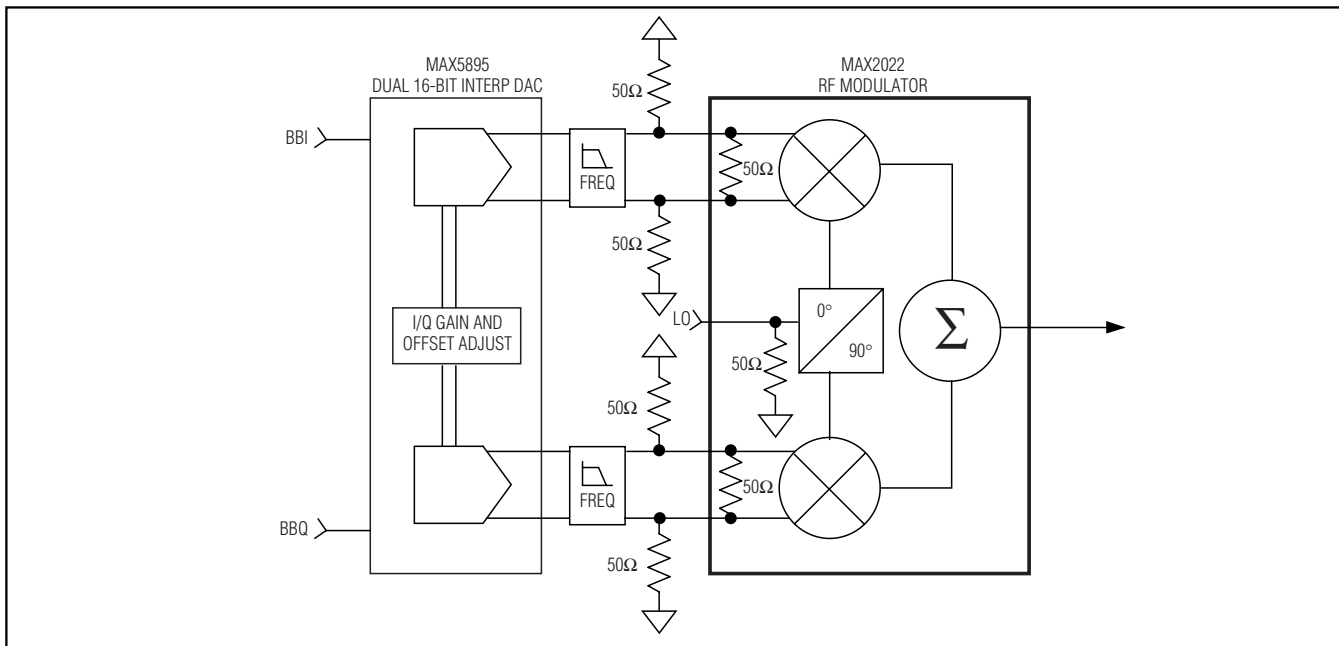

Figure 1. MAX5895 DAC Interfaced with MAX2022

High-Dynamic-Range, Direct Upconversion 1500MHz to 2500MHz Quadrature Modulator

resistor to ground, and a 10mA nominal DC output current results in a 0.5V common-mode DC level into the modulator I/Q inputs. The nominal signal level provided by the DACs will be in the -12dBm range for a single CDMA or WCDMA carrier, reducing to -18dBm per carrier for a four-carrier application.

The I/Q input bandwidth is greater than 50MHz at -0.1dB response. The direct connection of the DAC to the MAX2022 insures the maximum signal fidelity, with no performance-limiting baseband amplifiers required. The DAC output can be passed through a lowpass filter to remove the image frequencies from the DAC's output response. The MAX5895 dual interpolating DAC can be operated at interpolation rates up to x8. This has the benefit of moving the DAC image frequencies to a very high, remote frequency, easing the design of the baseband filters. The DAC's output noise floor and interpolation filter stopband attenuation are sufficiently good to insure that the 3GPP noise floor requirement is met for large frequency offsets, 60MHz for example, with no filtering required on the RF output of the modulator.

Figure 1 illustrates the ease and efficiency of interfacing the MAX2022 with a Maxim DAC, in this case the MAX5895 dual 16-bit interpolating-modulating DAC.

The MAX5895 DAC has programmable gain and differential offset controls built in. These can be used to optimize the LO leakage and sideband suppression of the MAX2022 quadrature modulator.

RF Output

The MAX2022 utilizes an internal passive mixer architecture. This enables a very low noise floor of -173.2dBm/Hz for low-level signals, below about

-20dBm output power level. For higher output level signals, the noise floor will be determined by the internal LO noise level at approximately -162dBc/Hz.

The I/Q input power levels and the insertion loss of the device will determine the RF output power level. The input power is the function of the delivered input I and Q voltages to the internal 50Ω termination. For simple sinusoidal baseband signals, a level of 89mV_{p-p} differential on the I and the Q inputs results in an input power level of -17dBm delivered to the I and Q internal 50Ω terminations. This results in a -27dBm RF output power.

Generation of WCDMA Carriers

The MAX2022 quadrature modulator makes an ideal signal source for the generation of multiple WCDMA carriers. The combination of high OIP3 and exceptionally low output noise floor gives an unprecedented output dynamic range. The output dynamic range allows the generation of four WCDMA carriers in the UMTS band with a noise floor sufficiently low to meet the 3GPP specification requirements with no additional RF filtering. This promotes an extremely simple and efficient transmitter lineup. Figure 2 illustrates a complete transmitter lineup for a multicarrier WCDMA transmitter in the UMTS band.

The MAX5895 dual interpolating-modulating DAC is operated as a baseband signal generator. For generation of four carriers of WCDMA modulation, and digital predistortion, an input data rate of 61.44 or 122.88Mbps can be used. The DAC can then be programmed to operate in x8 or x4 interpolation mode, resulting in a 491.52Msps output sample rate. The DAC will generate four carriers of WCDMA modulation

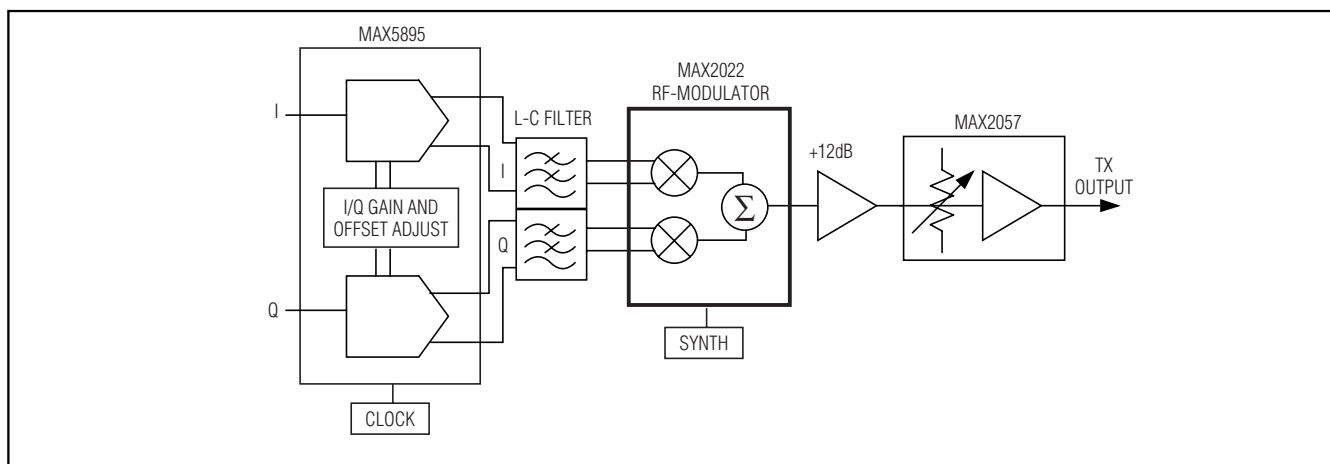

Figure 2. Complete Transmitter Lineup for a Multicarrier WCDMA in the UMTS Band

High-Dynamic-Range, Direct Upconversion 1500MHz to 2500MHz Quadrature Modulator

with an ACLR typically greater than 77dB under these conditions. The output power will be approximately -18dBm per carrier, with a noise floor typically less than -144dBc/Hz.

The MAX5895 DAC has built-in gain and offset fine adjustments. These are programmable by a 3-wire serial logic interface. The gain adjustment can be used to adjust the relative gains of the I and Q DAC outputs. This feature can be used to improve the native sideband suppression of the MAX2022 quadrature modulator. The gain adjustment resolution of 0.01dB allows sideband nulling down to approximately -60dB. The offset adjustment can similarly be used to adjust the offset DC output of each I and Q DAC. These offsets can then be used to improve the native LO leakage of the MAX2022. The DAC resolution of 4 LSBs will yield nulled LO leakage of typically less than -50dBc relative to four-carrier output levels.

The DAC outputs must be filtered by baseband filters to remove the image frequency signal components. The baseband signals for four-carrier operation cover DC to 10MHz. The image frequency appears at 481MHz to 491MHz. This very large frequency spread allows the use of very low-complexity lowpass filters, with excellent in-band gain and phase performance. The low DAC noise floor allows for the use of a very wideband filter, since the filter is not necessary to meet the 3GPP noise floor specification.

The MAX2022 quadrature modulator then upconverts the baseband signals to the RF output frequency. The output power of the MAX2022 will be approximately -28dBm per carrier. The noise floor will be less than -169dBm/Hz, with an ACLR typically greater than 65dBc. This performance meets the 3GPP specification requirements with substantial margins. The noise floor performance will be maintained for large offset frequencies, eliminating the need for subsequent RF filtering in the transmitter lineup.

The RF output from the MAX2022 is then amplified by a combination of a low-noise amplifier followed by a MAX2057 RF-VGA. This VGA can be used for lineup compensation for gain variance of transmitter and power amplifier elements. No significant degradation of the signal or noise levels will be incurred by this additional amplification. The MAX2057 will deliver an output

power of -6dBm per carrier, 0dBm total at an ACLR of 65dB and noise floor of -142dBc/Hz.

Layout Considerations

A properly designed PC board is an essential part of any RF/microwave circuit. Keep RF signal lines as short as possible to reduce losses, radiation, and inductance. For the best performance, route the ground pin traces directly to the exposed pad under the package. The PC board exposed paddle **MUST** be connected to the ground plane of the PC board. It is suggested that multiple vias be used to connect this pad to the lower-level ground planes. This method provides a good RF/thermal conduction path for the device. Solder the exposed pad on the bottom of the device package to the PC board. The MAX2022 evaluation kit can be used as a reference for board layout. Gerber files are available upon request at www.maxim-ic.com.

Power-Supply Bypassing

Proper voltage-supply bypassing is essential for high-frequency circuit stability. Bypass all VCC pins with 22pF and 0.1μF capacitors placed as close to the pins as possible. The smallest capacitor should be placed closest to the device.

To achieve optimum performance, use good voltage-supply layout techniques. The MAX2022 has several RF processing stages that use the various VCC pins, and while they have on-chip decoupling, off-chip interaction between them may degrade gain, linearity, carrier suppression, and output power-control range. Excessive coupling between stages may degrade stability.

Exposed Pad RF/Thermal Considerations

The EP of the MAX2022's 36-pin thin QFN-EP package provides a low thermal-resistance path to the die. It is important that the PC board on which the IC is mounted be designed to conduct heat from this contact. In addition, the EP provides a low-inductance RF ground path for the device.

The exposed paddle (EP) **MUST** be soldered to a ground plane on the PC board either directly or through an array of plated via holes. An array of 9 vias, in a 3 x 3 array, is suggested. Soldering the pad to ground is critical for efficient heat transfer. Use a solid ground plane wherever possible.

High-Dynamic-Range, Direct Upconversion 1500MHz to 2500MHz Quadrature Modulator

Pin Configuration/Functional Diagram

MAX2022

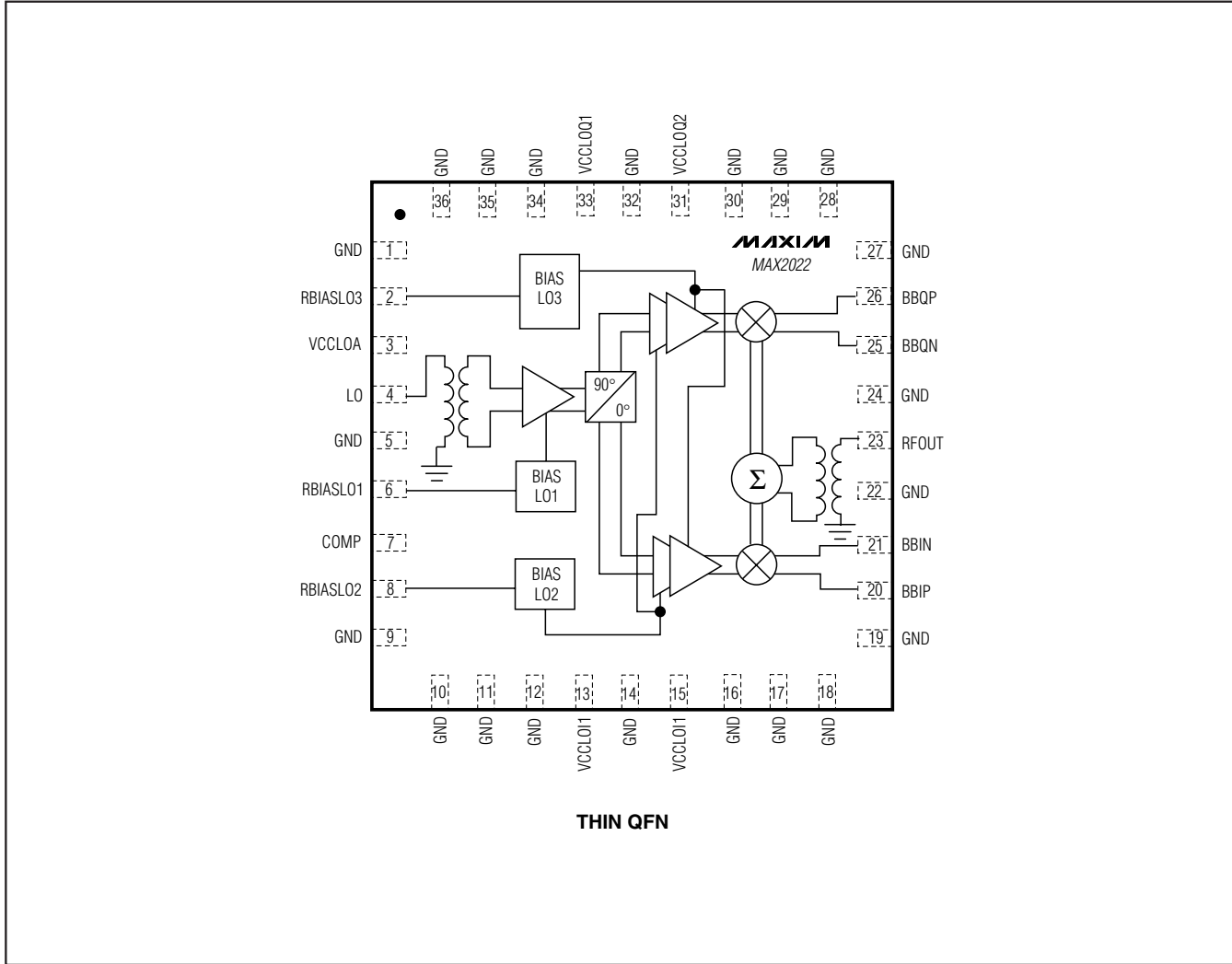

Chip Information

TRANSISTOR COUNT: 1414
PROCESS: SiGe BiCMOS

Package Information

For the latest package outline information, go to www.maxim-ic.com/packages.

