

LMH6601

250 MHz, 2.4V CMOS Op Amp with Shutdown

General Description

The LMH6601 is a low voltage (2.4V – 5.5V), high speed voltage feedback operational amplifier suitable for use in a variety of consumer and industrial applications. With a bandwidth of 125 MHz at a gain of +2 and guaranteed high output current of 100 mA, the LMH6601 is an ideal choice for video line driver applications including HDTV. Low input bias current (50 pA maximum), rail-to-rail output, and low current noise allow the LMH6601 to be used in various industrial applications such as transimpedance amplifiers, active filters, or high-impedance buffers. The LMH6601 is an attractive solution for systems which require high performance at low supply voltages. The LMH6601 is available in a 6-pin SC70 package, and includes a micropower shutdown feature.

Features

$V_S = 3.3V$, $T_A = 25^\circ C$, $A_V = 2 V/V$, $R_L = 150\Omega$ to V^- , unless specified.

- 125 MHz –3 dB small signal bandwidth
- 75 MHz –3 dB large signal bandwidth
- 30 MHz large signal 0.1 dB gain flatness
- 260 V/ μs slew rate
- 0.25%/0.25° differential gain/differential phase
- Rail-to-rail output
- 2.4V – 5.5V single supply operating range
- SC70-6 Package

Applications

- Video amplifier
- Charge amplifier
- Set-top box
- Sample & hold
- Transimpedance amplifier
- Line driver
- High impedance buffer

Response at a Gain of +2 for Various Supply Voltages

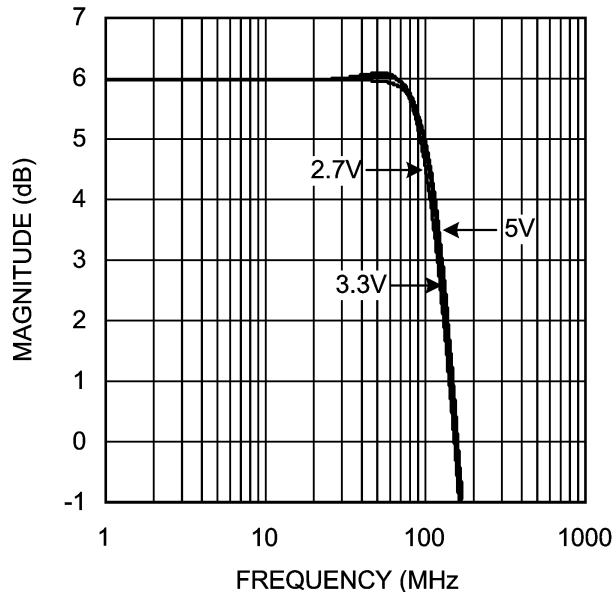

20136441

Absolute Maximum Ratings (Note 1)

If Military/Aerospace specified devices are required, please contact the National Semiconductor Sales Office/Distributors for availability and specifications.

ESD Tolerance (Note 4)	
Human Body Model	2 kV
Machine Model	200V
V _{IN} Differential	±2.5V
Input Current	±10 mA
Output Current	200 mA (Note 3)
Supply Voltage (V ⁺ – V ⁻)	6.0V
Voltage at Input/Output Pins	V ⁺ +0.5V, V ⁻ -0.5V

Storage Temperature Range	-65°C to +150°C
Junction Temperature	+150°C
Soldering Information	
Infrared or Convection (20 sec.)	235°C
Wave Soldering (10 sec.)	260°C

Operating Ratings (Note 1)

Supply Voltage (V ⁺ – V ⁻)	2.4V to 5.5V
Operating Temperature Range	-40°C to +85°C
Package Thermal Resistance (θ _{JA})	6-pin SC70
	414°C/W

5V Electrical Characteristics Single Supply with V_S = 5V, A_V = +2, R_F = 604Ω, SD tied to V⁺, V_{OUT} = V_S/2, R_L = 150Ω to V⁻ unless otherwise specified. **Boldface** limits apply at temperature extremes. (Note 2)

Symbol	Parameter	Condition	Min (Note 6)	Typ (Note 6)	Max (Note 6)	Units
Frequency Domain Response						
SSBW	-3 dB Bandwidth Small Signal	V _{OUT} = 0.25 V _{PP}		130		MHz
SSBW_1		V _{OUT} = 0.25 V _{PP} , A _V = +1		250		
Peak	Peaking	V _{OUT} = 0.25 V _{PP} , A _V = +1		2.5		dB
Peak_1	Peaking	V _{OUT} = 0.25 V _{PP}		0		dB
LSBW	-3 dB Bandwidth Large Signal	V _{OUT} = 2 V _{PP}		81		MHz
Peak_2	Peaking	V _{OUT} = 2 V _{PP}		0		dB
0.1 dB BW	0.1 dB Bandwidth	V _{OUT} = 2 V _{PP}		30		MHz
GBWP_1k	Gain Bandwidth Product	Unity Gain, R _L = 1 kΩ to V _S /2		155		MHz
GBWP_150		Unity Gain, R _L = 150Ω to V _S /2		125		
A _{VOL}	Large Signal Open Loop Gain	0.5V < V _{OUT} < 4.5V	56	66		dB
PBW	Full Power BW	-1 dB, A _V = +4, V _{OUT} = 4.2 V _{PP} , R _L = 150Ω to V _S /2		30		MHz
DG	Differential Gain	4.43 MHz, 1.7V ≤ V _{OUT} ≤ 3.3V, R _L = 150Ω to V ⁻		0.06		%
DP	Differential Phase	4.43 MHz, 1.7V ≤ V _{OUT} ≤ 3.3V R _L = 150Ω to V ⁻		0.10		deg
Time Domain Response						
TRS/TRL	Rise & Fall Time	0.25V Step		2.6		ns
OS	Overshoot	0.25V Step		10		%
SR	Slew Rate	2V Step		275		V/μs
T _S	Settling Time	1V Step, ±0.1%		50		ns
T _{S_1}		1V Step, ±0.02%		220		
PD	Propagation Delay	Input to Output, 250 mV Step, 50%		2.4		ns
C _L	Cap Load Tolerance	A _V = -1, 10% Overshoot, 75Ω in Series		50		pF
Distortion & Noise Performance						
HD2	Harmonic Distortion (2 nd)	2 V _{PP} , 10 MHz		-56		dBc
HD2_1		4 V _{PP} , 10 MHz, R _L = 1 kΩ to V _S /2		-61		
HD3	Harmonic Distortion (3 rd)	2 V _{PP} , 10 MHz		-73		dBc
HD3_1		4 V _{PP} , 10 MHz, R _L = 1 kΩ to V _S /2		-64		
THD	Total Harmonic Distortion	4 V _{PP} , 10 MHz, R _L = 1 kΩ to V _S /2		-58		
V _{N1}	Input Voltage Noise	>10 MHz		7		nV/√Hz
V _{N2}		1 MHz		10		
I _N	Input Current Noise	>1 MHz		50		fA/√Hz

5V Electrical Characteristics Single Supply with $V_S = 5V$, $A_V = +2$, $R_F = 604\Omega$, \overline{SD} tied to V^+ , $V_{OUT} = V_S/2$, $R_L = 150\Omega$ to V^- unless otherwise specified. **Boldface** limits apply at temperature extremes. (Note 2) (Continued)

Symbol	Parameter	Condition	Min (Note 6)	Typ (Note 6)	Max (Note 6)	Units
Static, DC Performance						
V_{IO}	Input Offset Voltage			± 1	± 2.4 ± 5.0	mV
DV_{IO}	Input Offset Voltage Average Drift	(Note 8)		-5		$\mu V/^\circ C$
I_B	Input Bias Current	(Note 9)		5	50	pA
I_{OS}	Input Offset Current	(Note 9)		2	25	pA
R_{IN}	Input Resistance			>100		G Ω
C_{IN}	Input Capacitance			1.3		pF
+PSRR	Positive Power Supply Rejection Ratio	DC	55 51	59		dB
-PSRR	Negative Power Supply Rejection Ratio	DC	53 50	61		dB
CMRR	Common Mode Rejection Ratio	DC	56 53	68		dB
CMVR	Input Voltage Range	CMRR > 50 dB	$V^- - 0.20$	-	$V^+ - 1.5$	V
I_{CC}	Supply Current	Normal Operation $V_{OUT} = V_S/2$		9.6	11.5 13.5	mA
		Shutdown \overline{SD} tied to $\leq 0.5V$ (Note 5)		100		nA
VOH1	Output High Voltage (Relative to V^+)	$R_L = 150\Omega$ to V^-	-210 -480	-190		mV
VOH2		$R_L = 75\Omega$ to $V_S/2$		-190		
VOH3		$R_L = 10\text{ k}\Omega$ to V^-	-60 -110	-12		
VOL1	Output Low Voltage (Relative to V^-)	$R_L = 150\Omega$ to V^-		+5	+45 +125	mV
VOL2		$R_L = 75\Omega$ to $V_S/2$		+120		
VOL3		$R_L = 10\text{ k}\Omega$ to V^-		+5	+45 +125	
I_O	Output Current	$V_{OUT} < 0.6V$ from Respective Supply	Source	150		mA
I_{O_1}			Sink	180		
		$V_{OUT} = V_S/2$, $V_{ID} = \pm 18\text{ mV}$ (Note 10)	± 100			
Load	Output Load Rating	THD < -30 dBc, $f = 200\text{ kHz}$, R_L tied to $V_S/2$, $V_{OUT} = 4 V_{PP}$		20		Ω
$R_{O_Enabled}$	Output Resistance	Enabled, $A_V = +1$		0.2		Ω
$R_{O_Disabled}$	Output Resistance	Shutdown		>100		M Ω
$C_{O_Disabled}$	Output Capacitance	Shutdown		5.0		pF
Miscellaneous Performance						
VDMAX	Voltage Limit for Disable (Pin 5)	(Note 5)	0		0.5	V
VDMIN	Voltage Limit for Enable (Pin 5)	(Note 5)	4.5		5.0	V
I_i	Logic Input Current (Pin 5)	$\overline{SD} = 5V$ (Note 5)		10		pA
V_{glitch}	Turn-on Glitch			2.2		V
T_{on}	Turn-on Time			1.4		μs
T_{off}	Turn-off Time			520		ns
Isolation _{OFF}	Off Isolation	1 MHz, $R_L = 1\text{ k}\Omega$		60		dB
T_{OL}	Overload Recovery			<20		ns

3.3V Electrical Characteristics

Single Supply with $V_S = 3.3V$, $A_V = +2$, $R_F = 604\Omega$, SD tied to V^+ , $V_{OUT} = V_S/2$, $R_L = 150\Omega$ to V^- unless otherwise specified. **Boldface** limits apply at temperature extremes. (Note 2)

Symbol	Parameter	Condition	Min (Note 6)	Typ (Note 6)	Max (Note 6)	Units
Frequency Domain Response						
SSBW	-3 dB Bandwidth Small Signal	$V_{OUT} = 0.25 V_{PP}$		125		MHz
SSBW_1		$V_{OUT} = 0.25 V_{PP}$, $A_V = +1$		250		
Peak	Peaking	$V_{OUT} = 0.25 V_{PP}$, $A_V = +1$		3		dB
Peak_1	Peaking	$V_{OUT} = 0.25 V_{PP}$		0.05		dB
LSBW	-3 dB Bandwidth Large Signal	$V_{OUT} = 2 V_{PP}$		75		MHz
Peak_2	Peaking	$V_{OUT} = 2 V_{PP}$		0		dB
0.1 dB BW	0.1 dB Bandwidth	$V_{OUT} = 2 V_{PP}$		30		MHz
GBWP_1k	Gain Bandwidth Product	Unity Gain, $R_L = 1 k\Omega$ to $V_S/2$		115		MHz
GBWP_150		Unity Gain, $R_L = 150\Omega$ to $V_S/2$		105		
A_{VOL}	Large Signal Open Loop Gain	$0.3V < V_{OUT} < 3V$	56	67		dB
PBW	Full Power BW	-1 dB, $A_V = +4$, $V_{OUT} = 2.8V_{PP}$, $R_L = 150\Omega$ to $V_S/2$		30		MHz
DG	Differential Gain	4.43 MHz, $0.85V \leq V_{OUT} \leq 2.45V$, $R_L = 150\Omega$ to V^-		0.06		%
DP	Differential Phase	4.43 MHz, $0.85V \leq V_{OUT} \leq 2.45V$, $R_L = 150\Omega$ to V^-		0.23		deg
Time Domain Response						
TRS/TRL	Rise & Fall Time	0.25V Step		2.7		ns
OS	Overshoot	0.25V Step		10		%
SR	Slew Rate	2V Step		260		V/ μ s
T_S	Settling Time	1V Step, $\pm 0.1\%$		70		ns
T_{S_1}		1V Step, $\pm 0.02\%$		300		
PD	Propagation Delay	Input to Output, 250 mV Step, 50%		2.6		ns
C_L	Cap Load Tolerance	$A_V = -1$, 10% Overshoot, 82 Ω in Series		50		pF
Distortion & Noise Performance						
HD2	Harmonic Distortion (2 nd)	$2 V_{PP}$, 10 MHz		-61		dBc
HD2_1		$2 V_{PP}$, 10 MHz $R_L = 1 k\Omega$ to $V_S/2$		-79		
HD3	Harmonic Distortion (3 rd)	$2 V_{PP}$, 10 MHz		-53		dBc
HD3_2		$2 V_{PP}$, 10 MHz $R_L = 1 k\Omega$ to $V_S/2$		-69		
THD	Total Harmonic Distortion	$2 V_{PP}$, 10 MHz $R_L = 1 k\Omega$ to $V_S/2$		-66		dBc
V_{N1}	Input Voltage Noise	>10 MHz		7		nV/ \sqrt{Hz}
V_{N2}		1 MHz		10		
I_N	Input Current Noise	>1 MHz		50		fA/ \sqrt{Hz}
Static, DC Performance						
V_{IO}	Input Offset Voltage			± 1	± 2.6 ± 5.5	mV
DV_{IO}	Input Offset Voltage Average Drift	(Note 8)		-4.5		$\mu V/^{\circ}C$
I_B	Input Bias Current	(Note 9)		5	50	pA
I_{OS}	Input Offset Current	(Note 9)		2	25	pA
R_{IN}	Input Resistance			>100		G Ω
C_{IN}	Input Capacitance			1.4		pF

3.3V Electrical Characteristics

Single Supply with $V_S = 3.3V$, $A_V = +2$, $R_F = 604\Omega$, \overline{SD} tied to V^+ , $V_{OUT} = V_S/2$, $R_L = 150\Omega$ to V^- unless otherwise specified. **Boldface** limits apply at temperature extremes. (Note 2) (Continued)

Symbol	Parameter	Condition	Min (Note 6)	Typ (Note 6)	Max (Note 6)	Units
+PSRR	Positive Power Supply Rejection Ratio	DC	61 51	80		dB
-PSRR	Negative Power Supply Rejection Ratio	DC	57 52	72		dB
CMRR	Common Mode Rejection Ratio	DC	58 55	73		dB
CMVR	Input Voltage Range	CMRR > 50 dB	V⁻ -0.20	–	V⁺ -1.5	V
I_{CC}	Supply Current	Normal Operation $V_{OUT} = V_S/2$		9.2	11 13	mA
		Shutdown \overline{SD} tied to $\leq 0.33V$ (Note 5)		100		nA
VOH1	Output High Voltage (Relative to V^+)	$R_L = 150\Omega$ to V^-	-210 -360	-190		mV
VOH2		$R_L = 75\Omega$ to $V_S/2$		-190		
VOH3		$R_L = 10\text{ k}\Omega$ to V^-	-50 -100	-10		
VOL1	Output Low Voltage (Relative to V^-)	$R_L = 150\Omega$ to V^-		+4	+45 +125	mV
VOL2		$R_L = 75\Omega$ to $V_S/2$		+105		
VOL3		$R_L = 10\text{ k}\Omega$ to V^-		+4	+45 +125	
I_O	Output Current	$V_{OUT} < 0.6V$ from Respective Supply	Source	50		mA
			Sink	75		
I_{O_1}		$V_{OUT} = V_S/2$, $V_{ID} = \pm 18\text{ mV}$ (Note 10)	± 75			
Load	Output Load Rating	THD < -30 dBc, $f = 200\text{ kHz}$, R_L tied to $V_S/2$, $V_{OUT} = 2.6 V_{PP}$		25		Ω
$R_{O_Enabled}$	Output Resistance	Enabled, $A_V = +1$		0.2		Ω
$R_{O_Disabled}$	Output Resistance	Shutdown		>100		M Ω
$C_{O_Disabled}$	Output Capacitance	Shutdown		5.6		pF
Miscellaneous Performance						
VDMAX	Voltage Limit for Disable (Pin 5)	(Note 5)	0		0.33	V
VDMIN	Voltage Limit for Enable (Pin 5)	(Note 5)	2.97		3.3	V
I_i	Logic Input Current (Pin 5)	$\overline{SD} = 3.3V$ (Note 5)		8		pA
$V_{_glitch}$	Turn-on Glitch			1.6		V
T_{on}	Turn-on Time			3.5		μs
T_{off}	Turn-off Time			500		ns
Isolation _{OFF}	Off Isolation	1 MHz, $R_L = 1\text{ k}\Omega$		60		dB

2.7V Electrical Characteristics

Single Supply with $V_S = 2.7V$, $A_V = +2$, $R_F = 604\Omega$, SD tied to V^+ , $V_{OUT} = V_S/2$, $R_L = 150\Omega$ to V^- unless otherwise specified. **Boldface** limits apply at temperature extremes. (Note 2)

Symbol	Parameter	Condition	Min (Note 6)	Typ (Note 6)	Max (Note 6)	Units
Frequency Domain Response						
SSBW	-3 dB Bandwidth Small Signal	$V_{OUT} = 0.25 V_{PP}$		120		MHz
SSBW_1		$V_{OUT} = 0.25 V_{PP}$, $A_V = +1$		250		
Peak	Peaking	$V_{OUT} = 0.25 V_{PP}$, $A_V = +1$		3.1		dB
Peak_1	Peaking	$V_{OUT} = 0.25 V_{PP}$		0.1		dB
LSBW	-3 dB Bandwidth Large Signal	$V_{OUT} = 2 V_{PP}$		73		MHz
Peak_2	Peaking	$V_{OUT} = 2 V_{PP}$		0		dB
0.1 dB BW	0.1 dB Bandwidth	$V_{OUT} = 2V_{PP}$		30		MHz
GBWP_1k	Gain Bandwidth Product	Unity Gain, $R_L = 1 k\Omega$ to $V_S/2$		110		MHz
GBWP_150		Unity Gain, $R_L = 150\Omega$ to $V_S/2$		81		
A_{VOL}	Large Signal Open Loop Gain	$0.25V < V_{OUT} < 2.5V$	56	65		dB
PBW	Full Power BW	-1 dB, $A_V = +4$, $V_{OUT} = 2 V_{PP}$, $R_L = 150\Omega$ to $V_S/2$		13		MHz
DG	Differential Gain	4.43 MHz, $0.45V \leq V_{OUT} \leq 2.05V$ $R_L = 150\Omega$ to V^-		0.12		%
DP	Differential Phase	4.43 MHz, $0.45V \leq V_{OUT} \leq 2.05V$ $R_L = 150\Omega$ to V^-		0.62		deg
Time Domain Response						
TRS/TRL	Rise & Fall Time	0.25V Step		2.7		ns
OS	Overshoot	0.25V Step		10		%
SR	Slew Rate	2V Step		260		V/ μ s
T_S	Settling Time	1V Step, $\pm 0.1\%$		147		ns
T_{S_1}		1V Step, $\pm 0.02\%$		410		
PD	Propagation Delay	Input to Output, 250 mV Step, 50%		3.4		ns
Distortion & Noise Performance						
HD2	Harmonic Distortion (2 nd)	1 V_{PP} , 10 MHz		-58		dBc
HD3	Harmonic Distortion (3 rd)	1 V_{PP} , 10 MHz		-60		dBc
V_{N1}	Input Voltage Noise	>10 MHz		8.4		nV/ \sqrt{Hz}
V_{N2}		1 MHz		12		
I_N	Input Current Noise	>1 MHz		50		fA/ \sqrt{Hz}
Static, DC Performance						
V_{IO}	Input Offset Voltage			± 1	± 3.5 ± 6.5	mV
DV_{IO}	Input Offset Voltage Average Drift	(Note 8)		-6.5		μ V/ $^\circ$ C
I_B	Input Bias Current	(Note 9)		5	50	pA
I_{OS}	Input Offset Current	(Note 9)		2	25	pA
R_{IN}	Input Resistance			>100		G Ω
C_{IN}	Input Capacitance			1.6		pF
+PSRR	Positive Power Supply Rejection Ratio	DC	58 53	68		dB
-PSRR	Negative Power Supply Rejection Ratio	DC	56 53	69		dB
CMRR	Common Mode Rejection Ratio	DC	57 52	77		dB
CMVR	Input Voltage Range	CMRR > 50 dB	V⁻ -0.20	-	V⁺ -1.5	V

2.7V Electrical Characteristics

Single Supply with $V_S = 2.7V$, $A_V = +2$, $R_F = 604\Omega$, \overline{SD} tied to V^+ , $V_{OUT} = V_S/2$, $R_L = 150\Omega$ to V^- unless otherwise specified. **Boldface** limits apply at temperature extremes. (Note 2) (Continued)

Symbol	Parameter	Condition	Min (Note 6)	Typ (Note 6)	Max (Note 6)	Units
I_{CC}	Supply Current	Normal Operation $V_{OUT} = V_S/2$		9.0	10.6 12.5	mA
		Shutdown \overline{SD} tied to $\leq 0.27V$ (Note 5)		100		
VOH1	Output High Voltage (Relative to V^+)	$R_L = 150\Omega$ to V^-	-260 -420	-200		mV
VOH2		$R_L = 75\Omega$ to $V_S/2$		-200		
VOH3		$R_L = 10\text{ k}\Omega$ to V^-	-50 100	-10		
VOL1	Output Low Voltage (Relative to V^-)	$R_L = 150\Omega$ to V^-		+4	+45 +125	mV
VOL2		$R_L = 75\Omega$ to $V_S/2$		+125		
VOL3		$R_L = 10\text{ k}\Omega$ to V^-		+4	+45 125	
I_O	Output Current	$V_{OUT} \leq 0.6V$ from Respective Supply	Source		25	mA
			Sink		62	
I_{O_1}		$V_{OUT} = V_S/2$, $V_{ID} = \pm 18$ mV (Note 10)	Source	25		
			Sink	35		
Load	Output Load Rating	THD < -30 dBc, $f = 200\text{ kHz}$, R_L tied to $V_S/2$, $V_{OUT} = 2.2 V_{PP}$		40		Ω
R_{O_Enable}	Output Resistance	Enabled, $A_V = +1$		0.2		Ω
$R_{O_Disabled}$	Output Resistance	Shutdown		>100		M Ω
$C_{O_Disabled}$	Output Capacitance	Shutdown		5.6		pF
Miscellaneous Performance						
VDMAX	Voltage Limit for Disable (Pin 5)	(Note 5)	0		0.27	V
VDMIN	Voltage Limit for Enable (Pin 5)	(Note 5)	2.43		2.7	V
I_i	Logic Input Current (Pin 5)	$\overline{SD} = 2.7V$ (Note 5)		4		pA
$V_{_glitch}$	Turn-on Glitch			1.2		V
T_{on}	Turn-on Time			5.2		μs
T_{off}	Turn-off Time			760		ns
Isolation _{OFF}	Off Isolation	1 MHz, $R_L = 1\text{ k}\Omega$		60		dB

Note 1: Absolute Maximum Ratings indicate limits beyond which damage to the device may occur. Operating Ratings indicate conditions for which the device is intended to be functional, but specific performance is not guaranteed. For guaranteed specifications and the test conditions, see the Electrical Characteristics.

Note 2: Electrical Table values apply only for factory testing conditions at the temperature indicated. Factory testing conditions result in very limited self-heating of the device such that $T_J = T_A$. No guarantee of parametric performance is indicated in the electrical tables under conditions of internal self-heating where $T_J > T_A$.

Note 3: The maximum continuous output current (I_{OUT}) is determined by device power dissipation limitations.

Note 4: Human Body Model is 1.5 k Ω in series with 100 pF. Machine Model is 0 Ω in series with 200 pF.

Note 5: \overline{SD} logic is CMOS compatible. To ensure proper logic level and to minimize power supply current, \overline{SD} should typically be less than 10% of total supply voltage away from either supply rail.

Note 6: Typical numbers are the most likely parametric norm. Bold numbers refer to over temperature limits.

Note 7: Negative input current implies current flowing out of the device.

Note 8: Drift determined by dividing the change in parameter at temperature extremes by the total temperature change.

Note 9: Guaranteed by design.

Note 10: " V_{ID} " is input differential voltage (input overdrive).

Connection Diagram

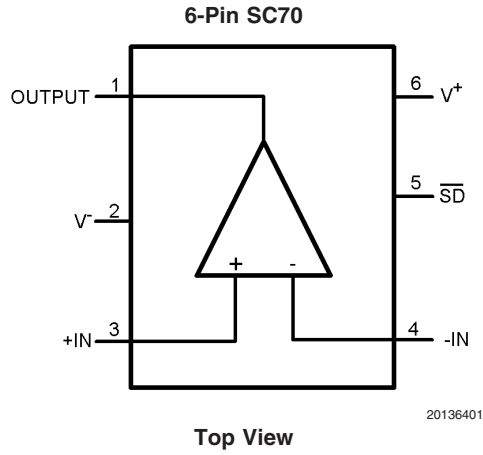

Ordering Information

Package	Part Number	Package Marking	Transport Media	NSC Drawing
6-Pin SC70	LMH6601MG	A95	1k Units Tape and Reel	MAA06A
	LMH6601MGX		3k Units Tape and Reel	

Typical Performance Characteristics Unless otherwise noted, all data is with $A_V = +2$, $R_F = R_G = 604\Omega$, $V_S = 3.3V$, $V_{OUT} = V_S/2$, \overline{SD} tied to V^+ , $R_L = 150\Omega$ to V^- , $T = 25^\circ C$.

Frequency Response for Various Output Amplitudes

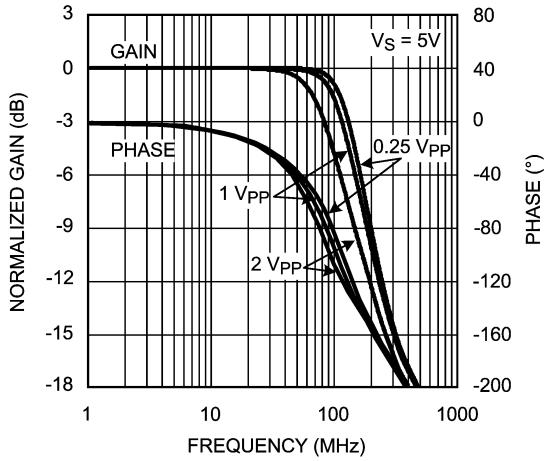

20136413

Frequency Response for Various Output Amplitudes

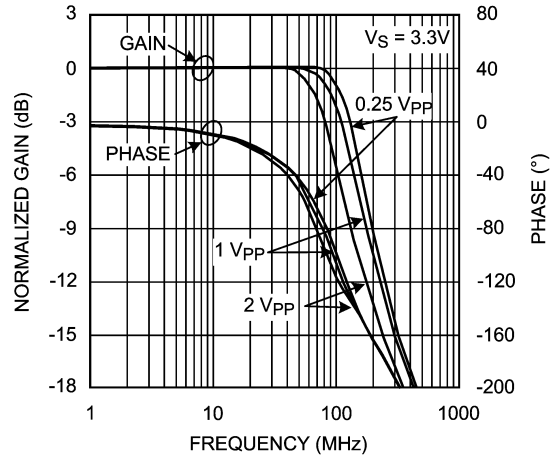

20136414

Frequency Response for Various Output Amplitudes

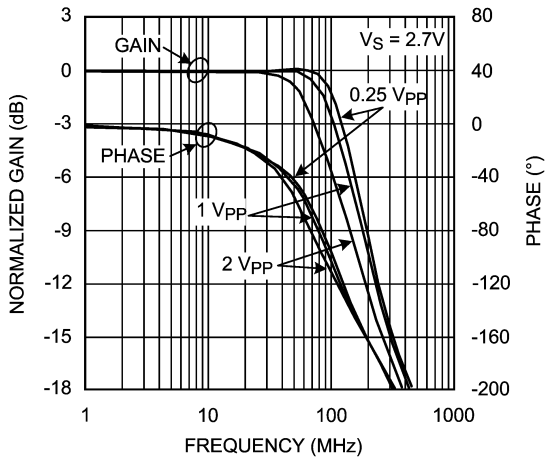

20136415

-3 dB BW vs. Supply Voltage for Various Output Swings

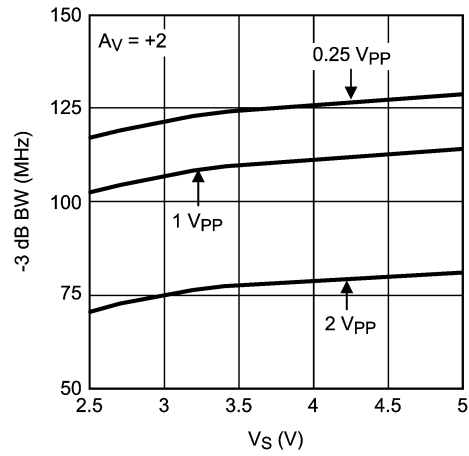

20136420

Non-inverting Frequency Response for Various Gain

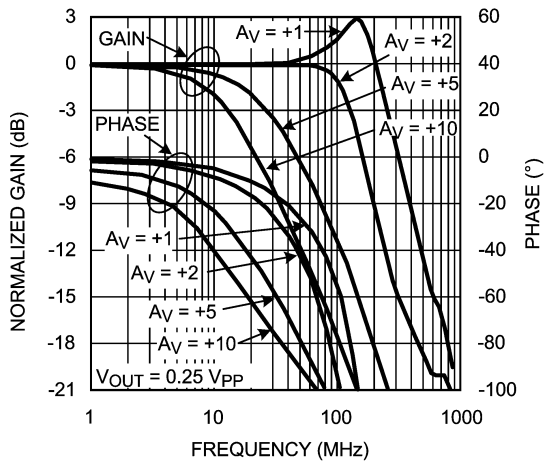

20136416

Inverting Frequency Response for Various Gain

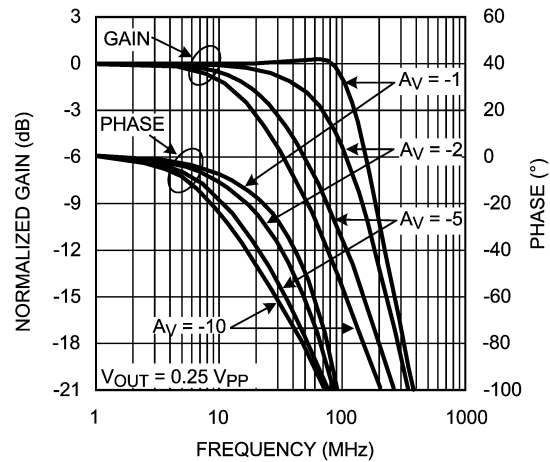

20136417

Typical Performance Characteristics Unless otherwise noted, all data is with $A_V = +2$, $R_F = R_G = 604\Omega$, $V_S = 3.3V$, $V_{OUT} = V_S/2$, \overline{SD} tied to V^+ , $R_L = 150\Omega$ to V^- , $T = 25^\circ C$. (Continued)

Frequency Response for Various Loads

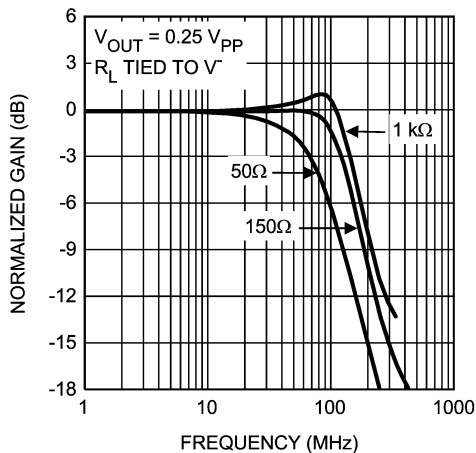

20136419

Frequency Response for Various Supply Voltages

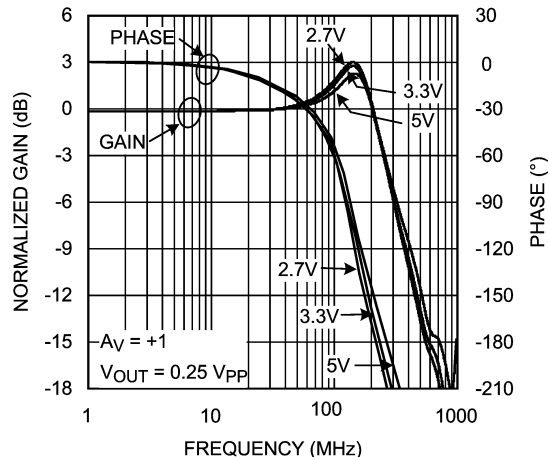

20136421

-3 dB BW vs. Ambient Temperature

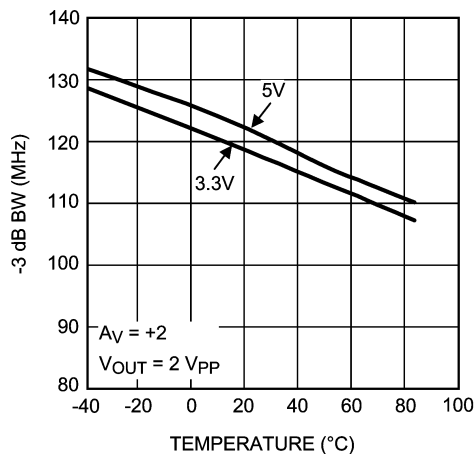

20136422

Frequency Response for Various Cap Load

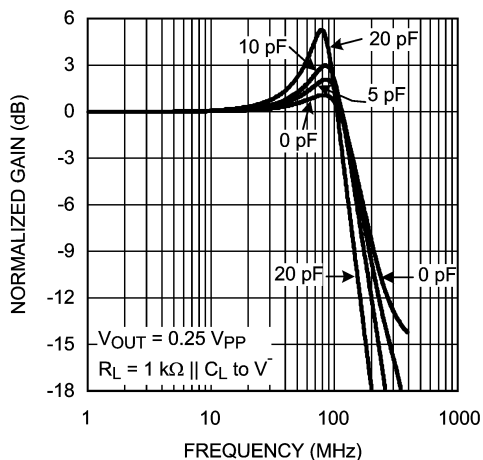

20136418

Frequency Response for Various Supply Voltage

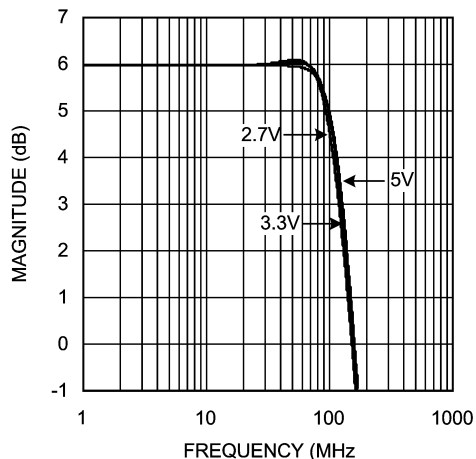

20136441

Max Output Swing vs. Frequency

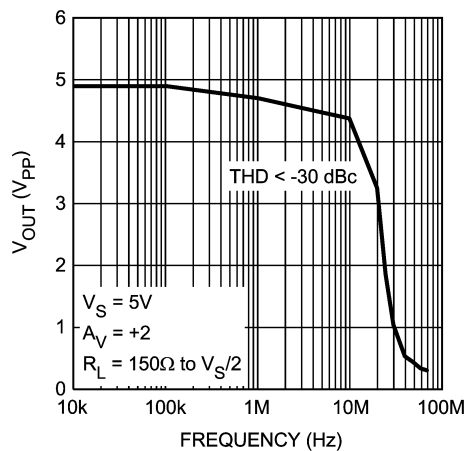

20136426

Typical Performance Characteristics Unless otherwise noted, all data is with $A_V = +2$, $R_F = R_G = 604\Omega$, $V_S = 3.3V$, $V_{OUT} = V_S/2$, \overline{SD} tied to V^+ , $R_L = 150\Omega$ to V^- , $T = 25^\circ C$. (Continued)

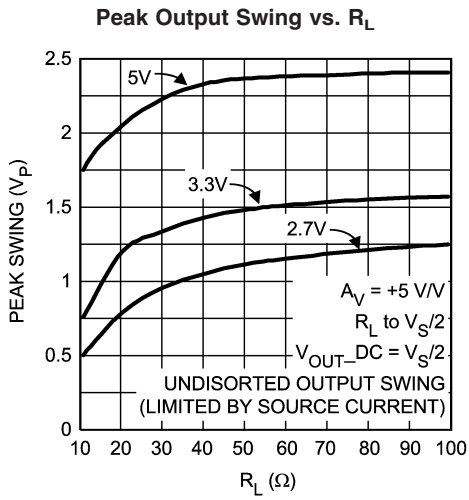

Output Swing vs. Sink Current for Various Supply Voltages

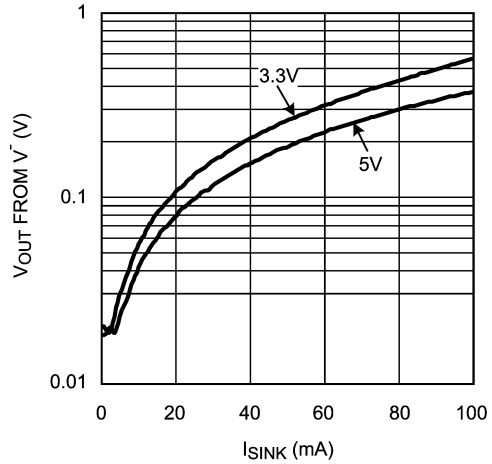

Output Swing vs. Source Current for Various Supply Voltages

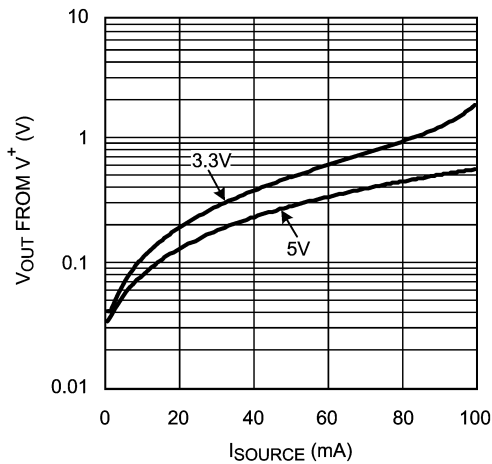

HD2 vs. Frequency

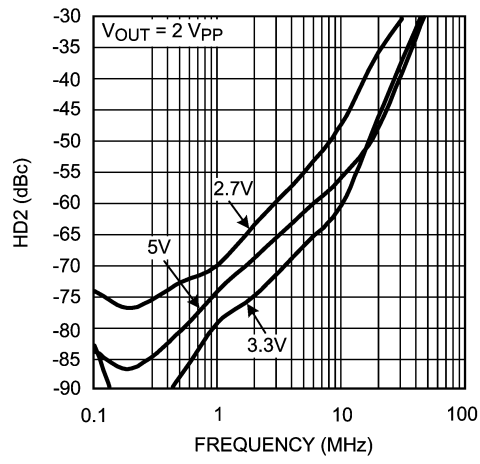

HD3 vs. Frequency

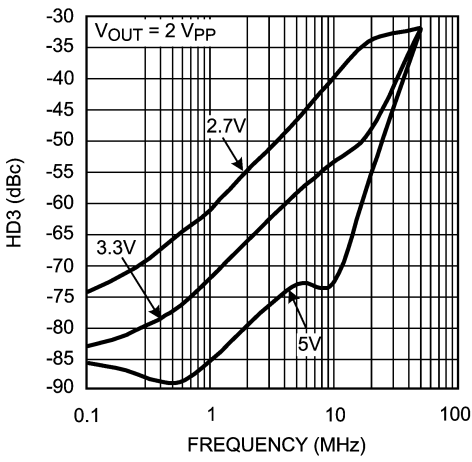

THD vs. Output Swing

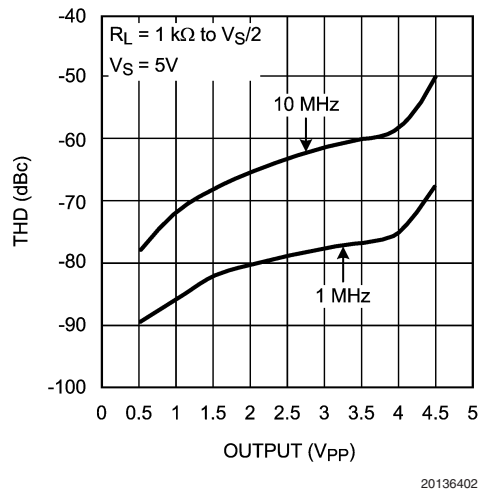

Typical Performance Characteristics Unless otherwise noted, all data is with $A_V = +2$, $R_F = R_G = 604\Omega$, $V_S = 3.3V$, $V_{OUT} = V_S/2$, \overline{SD} tied to V^+ , $R_L = 150\Omega$ to V^- , $T = 25^\circ C$. (Continued)

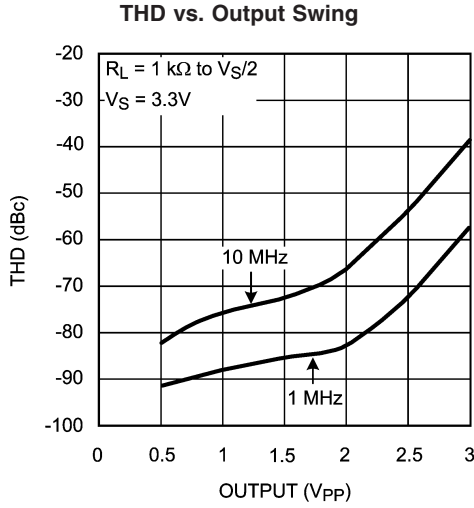

20136403

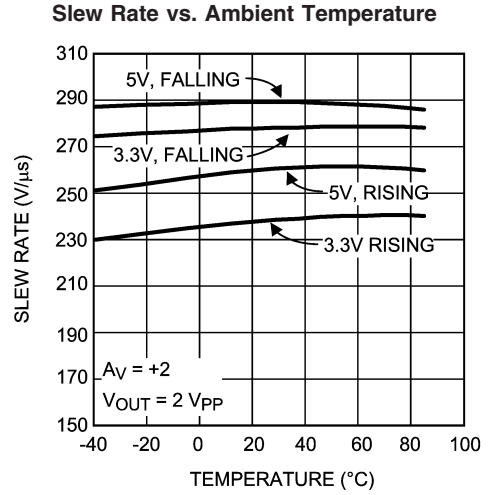

20136423

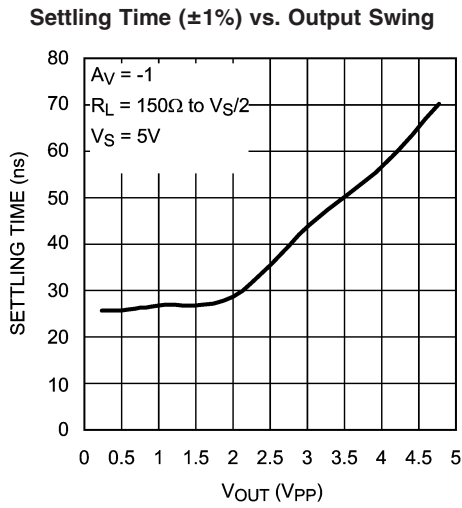

20136411

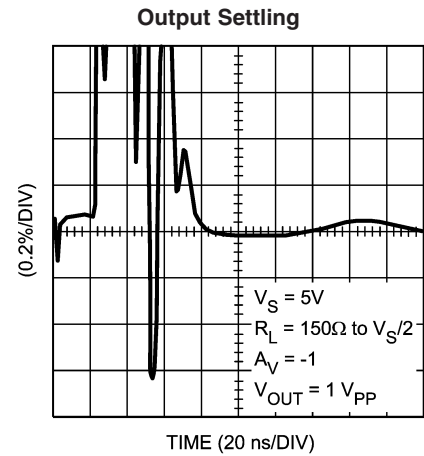

20136412

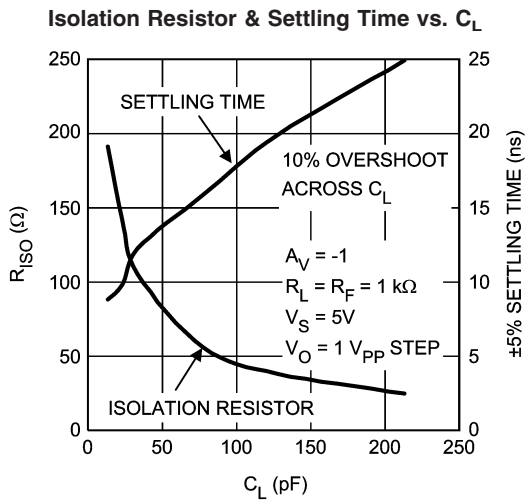

20136428

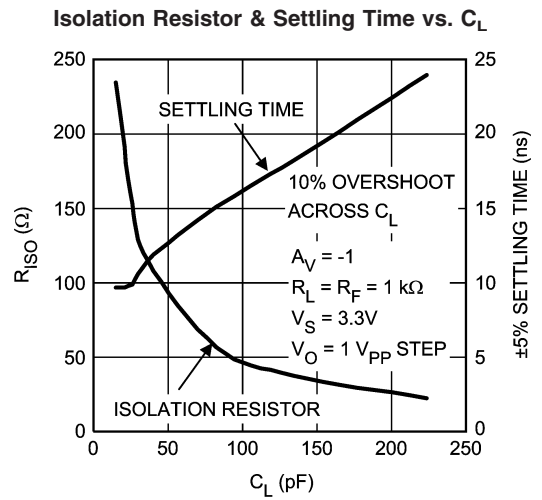

20136429

Typical Performance Characteristics Unless otherwise noted, all data is with $A_V = +2$, $R_F = R_G = 604\Omega$, $V_S = 3.3V$, $V_{OUT} = V_S/2$, \overline{SD} tied to V^+ , $R_L = 150\Omega$ to V^- , $T = 25^\circ C$. (Continued)

Closed Loop Output Impedance vs. Frequency for Various Supply Voltages

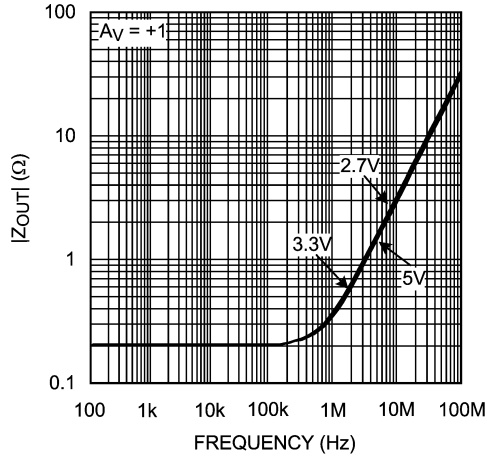

20136410

Off Isolation vs. Frequency

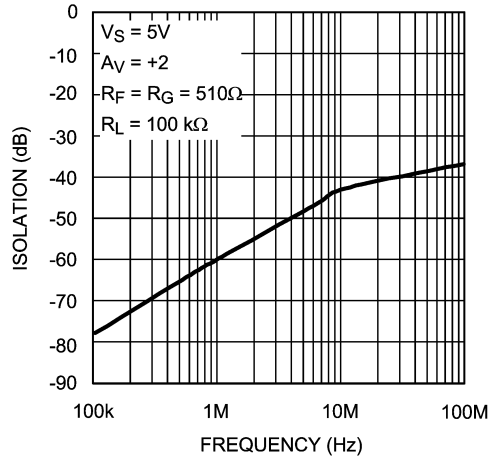

20136408

Noise Voltage vs. Frequency

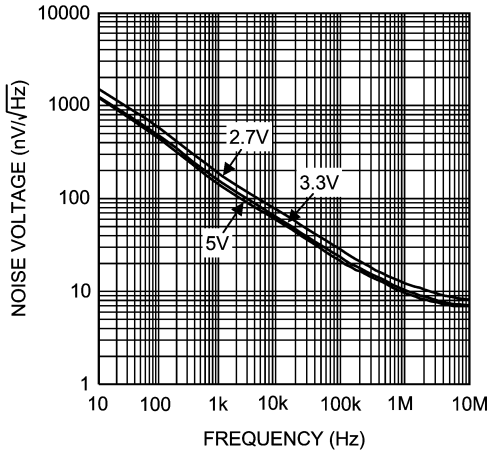

20136424

Open Loop Gain/ Phase

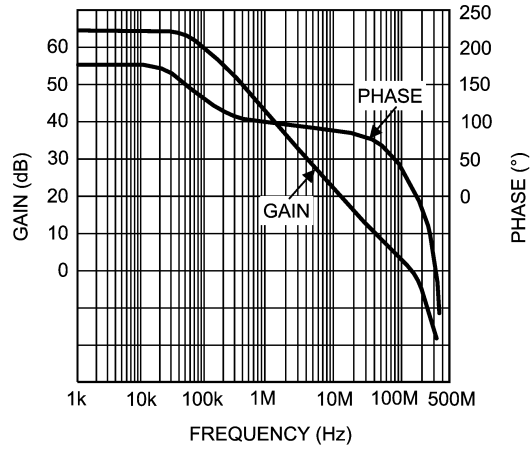

20136435

CMRR vs. Frequency

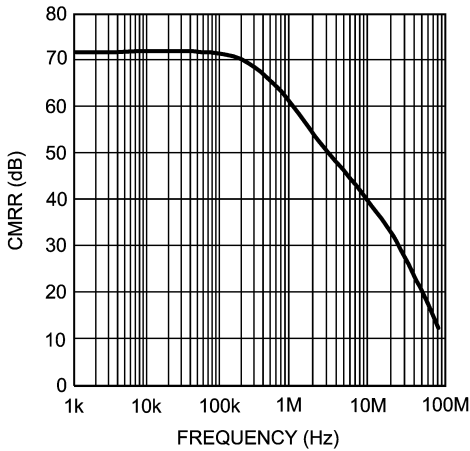

20136425

+PSRR vs. Frequency

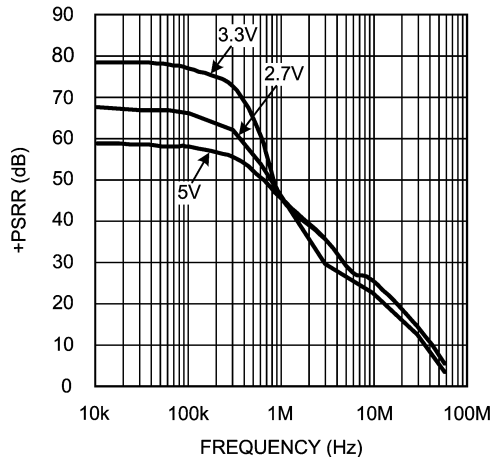

20136439

Typical Performance Characteristics Unless otherwise noted, all data is with $A_V = +2$, $R_F = R_G = 604\Omega$, $V_S = 3.3V$, $V_{OUT} = V_S/2$, \overline{SD} tied to V^+ , $R_L = 150\Omega$ to V^- , $T = 25^\circ C$. (Continued)

-PSRR vs. Frequency

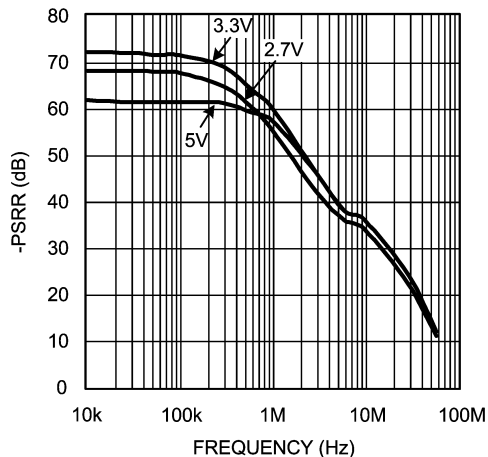

20136440

Supply Current vs. Ambient Temperature

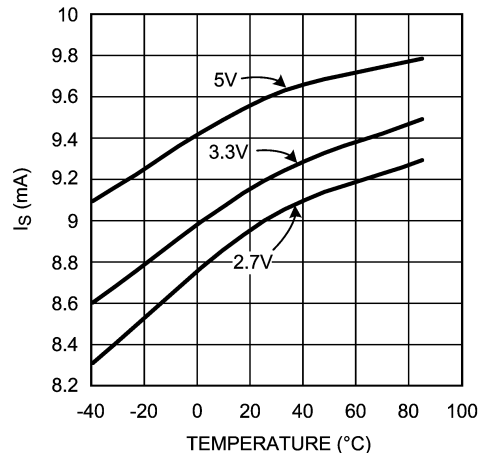

20136433

Supply Current vs. V_{CM}

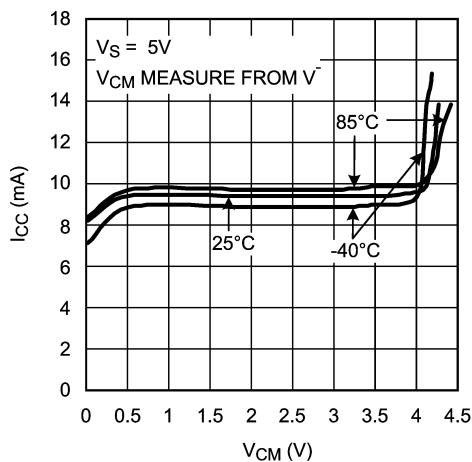

20136437

Supply Current vs. Supply Voltage

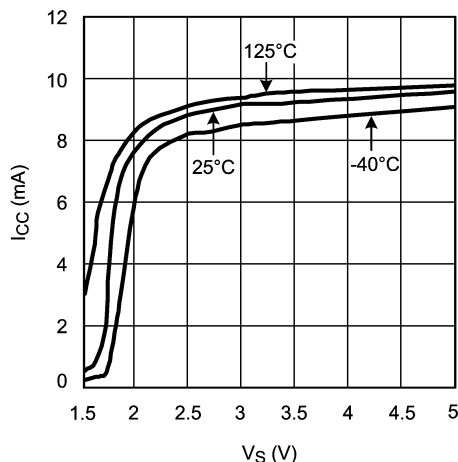

20136467

Offset Voltage vs. Ambient Temperature for 3 Representative Units

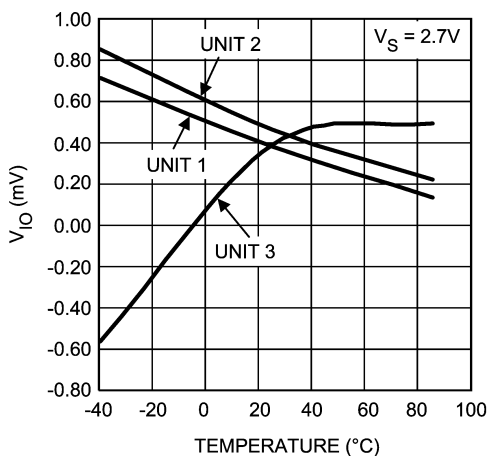

20136434

Offset Voltage Distribution

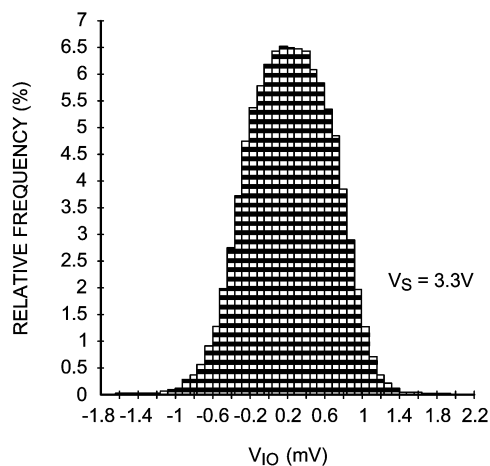

20136436

Typical Performance Characteristics Unless otherwise noted, all data is with $A_V = +2$, $R_F = R_G = 604\Omega$, $V_S = 3.3V$, $V_{OUT} = V_S/2$, \overline{SD} tied to V^+ , $R_L = 150\Omega$ to V^- , $T = 25^\circ C$. (Continued)

Offset Voltage vs. V_{CM} (Typical Part)

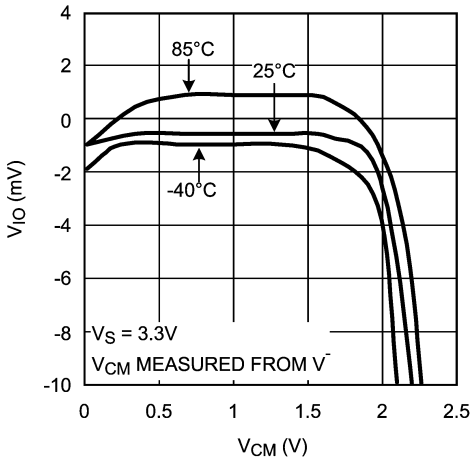

20136438

Input Bias Current vs. Common Mode Voltage

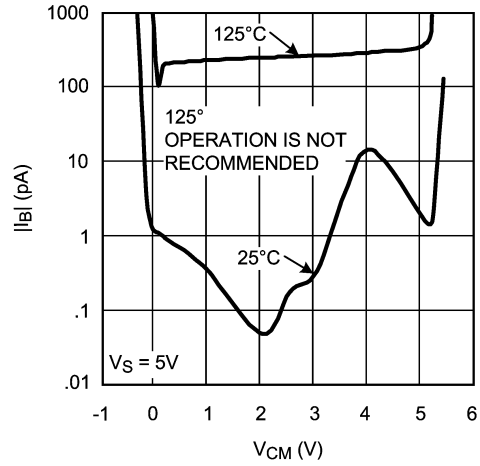

20136442

Small Signal Step Response

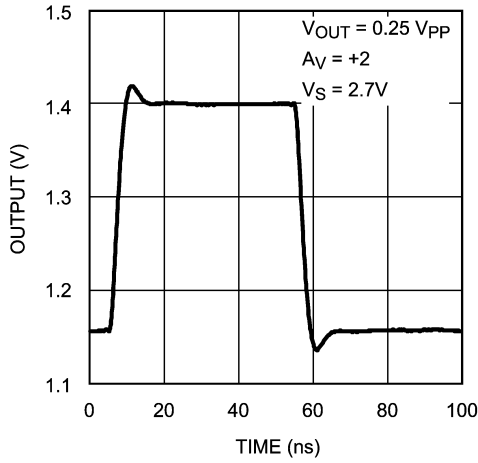

20136431

Large Signal Step Response

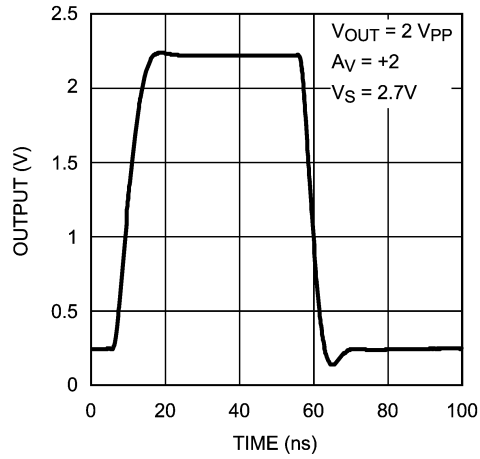

20136430

Large Signal Step Response

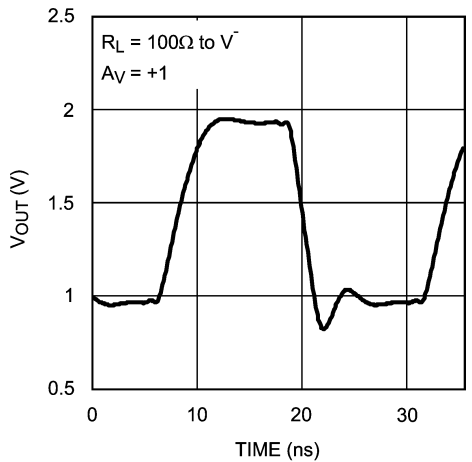

20136432

Turn On/Off Waveform

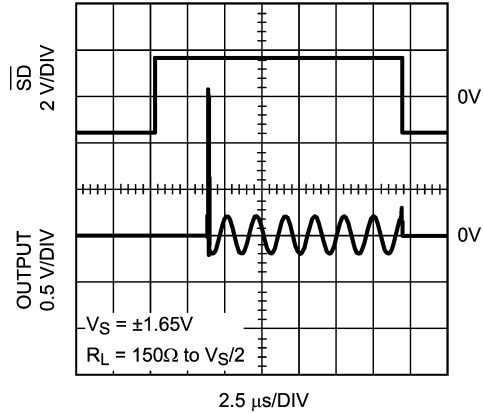

20136466

Typical Performance Characteristics Unless otherwise noted, all data is with $A_V = +2$, $R_F = R_G = 604\Omega$, $V_S = 3.3V$, $V_{OUT} = V_S/2$, \overline{SD} tied to V^+ , $R_L = 150\Omega$ to V^- , $T = 25^\circ C$. (Continued)

DG vs. V_{OUT} for Various V_S

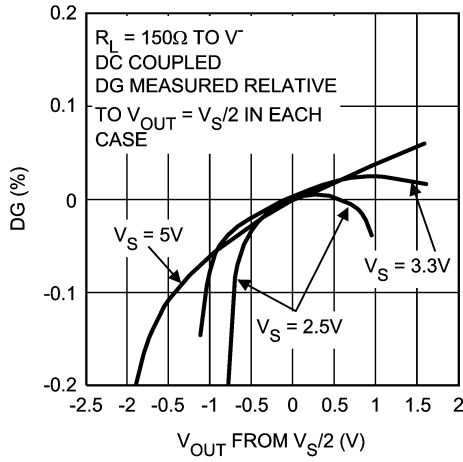

20136471

DP vs. V_{OUT} for Various V_S

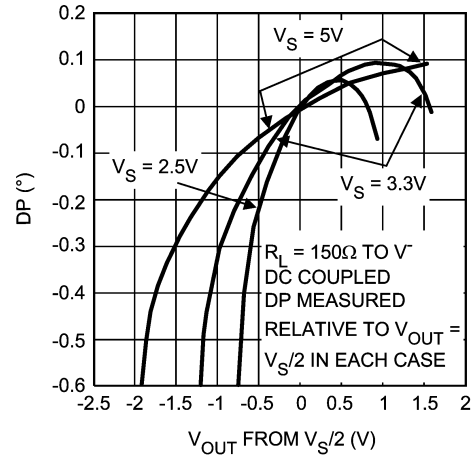

20136472

DG vs. V_{OUT} (DC and AC Coupled Load Compared)

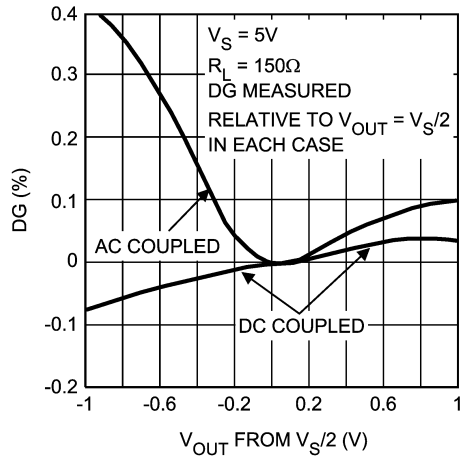

20136473

DP vs. V_{OUT} (DC and AC Coupled Load Compared)

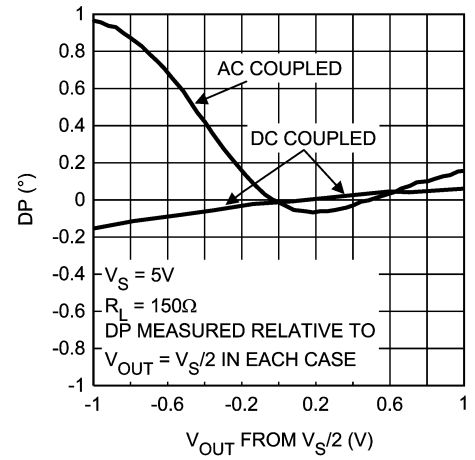

20136474

Application Information

OPTIMIZING PERFORMANCE

With many op amps, additional device non-linearity and sometimes less loop stability arises when the output has to switch from current-source mode to current-sink mode or vice versa. When it comes to achieving the lowest distortion and the best Differential Gain/ Differential Phase (DG/ DP, broadcast video specs), the LMH6601 is optimized for single supply DC coupled output applications where the load current is returned to the negative rail (V^-). That is where the output stage is most linear (lowest distortion) and which corresponds to unipolar current flowing out of this device. To that effect, it is easy to see that the distortion specifications improve when the output is only sourcing current which is the distortion-optimized mode of operation for the LMH6601. In application where the LMH6601 output is AC coupled or when it is powered by separate dual supplies for V^+ and V^- , the output stage supplies both source and sink current to the load and results in less than optimum distortion (and DG/ DP). *Figure 1* compares the distortion results between a DC and an AC coupled load to show the magnitude of this difference. See the DG/DP plots in the Typical Performance Characteristics section for a comparison between DC and AC coupling of the video load.

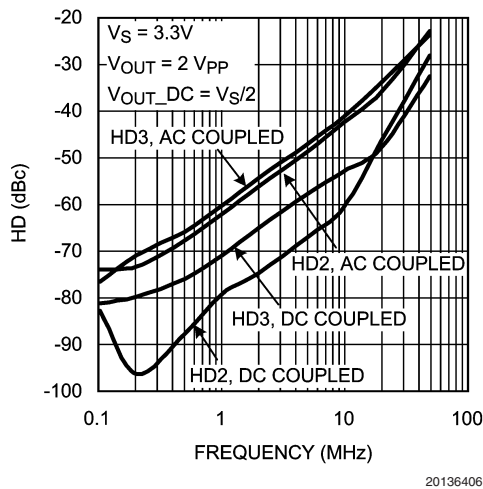

FIGURE 1. Distortion Comparison between DC & AC Coupling of the Load

In certain applications, it may be possible to optimize the LMH6601 for best distortion (and DG/DP) even though the load may require bipolar output current by adding a pull-down resistor to the output. Adding an output pull-down resistance of appropriate value could change the LMH6601 output loading into source-only. This comes at the price of higher total power dissipation and increased output current requirement.

Figure 2 shows how to calculate the pull-down resistor value for both the dual supply and for the AC coupled load applications.

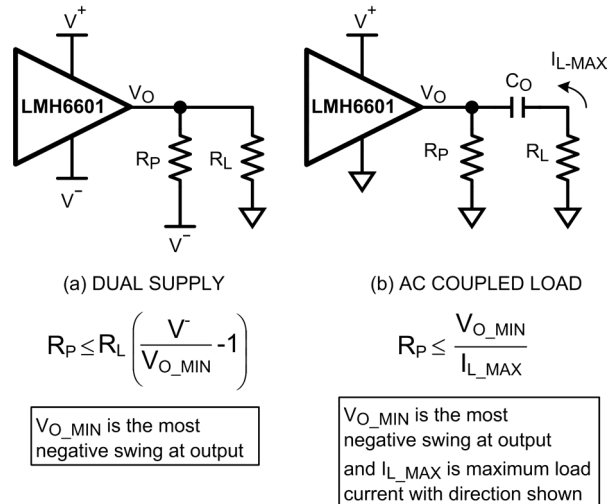

FIGURE 2. Output Pull-Down Value for Dual Supply & AC Coupling

Furthermore, with a combination of low closed loop gain setting (i.e. $A_V = +1$ for example where device bandwidth is the highest), light output loading ($R_L > 1 \text{ k}\Omega$), and with a significant capacitive load ($C_L > 10 \text{ pF}$), the LMH6601 is most stable if output sink current is kept to less than about 5 mA. The pull-down method described in *Figure 2* is applicable in these cases as well where the current that would normally be sunk by the op amp is diverted to the R_P path instead.

SHUTDOWN CAPABILITY AND TURN ON/ OFF BEHAVIOR

With the device in shutdown mode, the output goes into high impedance ($R_{OUT} > 100 \text{ M}\Omega$) mode. In this mode, the only path between the inputs and the output pin is through the external components around the device. So, for applications where there is active signal connection to the inverting input, with the LMH6601 in shutdown, the output could show signal swings due to current flow through these external components. For non-inverting amplifiers in shutdown, no output swings would occur, because of complete input-output isolation, with the exception of capacitive coupling.

For maximum power saving, the LMH6601 supply current drops to around $0.1 \mu\text{A}$ in shutdown. All significant power consumption within the device is disabled for this purpose. Because of this, the LMH6601 turn on time is measured in micro-seconds whereas its turn off is fast (nano-seconds) as would be expected from a high speed device like this.

The LMH6601 $\overline{\text{SD}}$ pin is a CMOS compatible input with a pico-ampere range input current drive requirement. This pin needs to be tied to a level or otherwise the device state would be indeterminate. The device shutdown threshold is half way between the V^+ and V^- pin potentials at any supply voltage. For example, with V^+ tied to 10V and V^- equal to 5V, you can expect the threshold to be at 7.5V. The state of the device (shutdown or normal operation) is guaranteed over temperature as long as the $\overline{\text{SD}}$ pin is held to within 10% of the total supply voltage.

For $V^+ = 10\text{V}$, $V^- = 5\text{V}$, as an example:

- Shutdown Range $5\text{V} \leq \overline{\text{SD}} \leq 5.5\text{V}$
- Normal Operation Range $9.5\text{V} \leq \overline{\text{SD}} \leq 10\text{V}$

Application Information (Continued)

OVERLOAD RECOVERY AND SWING CLOSE TO RAILS

The LMH6601 can recover from an output overload in less than 20 ns. See *Figure 3* below for the input and output scope photos:

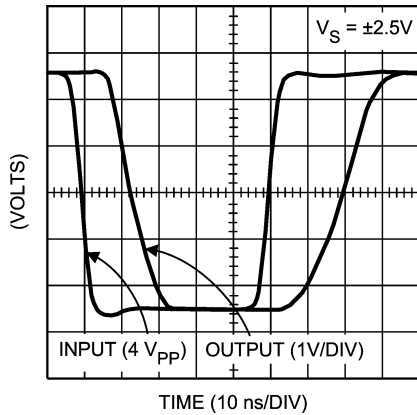

FIGURE 3. LMH6601 Output Overload Recovery Waveform

In *Figure 3*, the input step function is set so that the output is driven to one rail and then the other and then the output recovery is measured from the time the input crosses 0V to when the output reaches this point.

Also, when the LMH6601 input voltage range is exceeded near the V^+ rail, the output does not experience output phase reversal, as some op amps do. This is particularly advantageous in applications where output phase reversal has to be avoided at all costs, such as in servo loop control among others. This adds to the LMH6601's set of features which make this device easy to use.

In addition, the LMH6601's output swing close to either rail is well-behaved as can be seen in the scope photo of *Figure 4*.

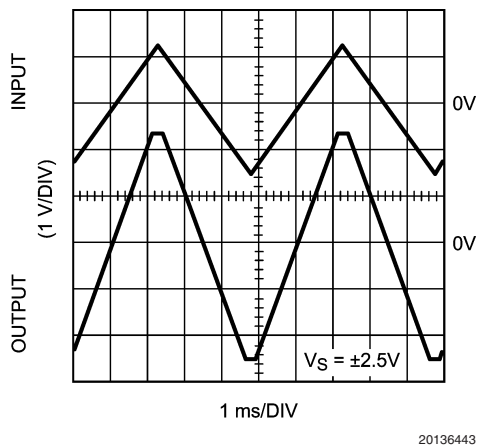

FIGURE 4. LMH6601's "Clean" Swing to Either Rail

With some op amps, when the output approaches either one or both rails and saturation starts to set in, there is significant increase in the transistor parasitic capacitances which leads to loss of Phase Margin. That is why with these devices, there are sometimes hints of instability with output close to the rails. With the LMH6601, as can be seen in *Figure 4*, the output waveform remains free of instability throughout its range of voltages.

SINGLE SUPPLY VIDEO APPLICATION

The LMH6601's high speed and fast slew rate make it an ideal choice for video amplifier and buffering applications. There are cost benefits in having a single operating supply. Single supply video systems can take advantage of the LMH6601's low supply voltage operation along with its ability to operate with input common mode voltages at or slightly below the V^- rail. Additional cost savings can be achieved by eliminating or reducing the value of the input and output AC coupling capacitors commonly employed in single supply video applications. This Application section shows some circuit techniques used to help in doing just that.

DC COUPLED, SINGLE SUPPLY BASEBAND VIDEO AMPLIFIER/DRIVER

The LMH6601 output can swing very close to either rail to maximize the output dynamic range which is of particular interest when operating in a low voltage single supply environment. Under light output load conditions, the output can swing as close as a few milli-volts of either rail. This also allows a video amplifier to preserve the video black level for excellent video integrity. In the example shown below in *Figure 5*, the baseband video output is amplified and buffered by the LMH6601 which then drives the 75Ω back terminated video cable for an overall gain of +1 delivered to the 75Ω load. The input video would normally have a level between 0V to approximately 0.75V.

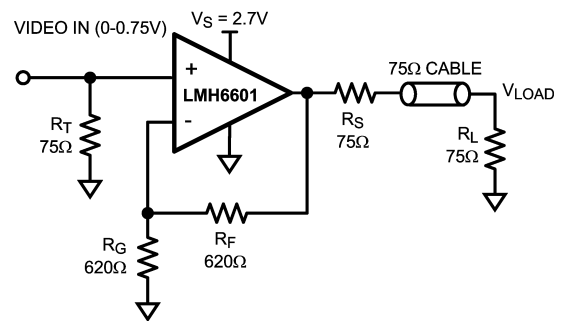
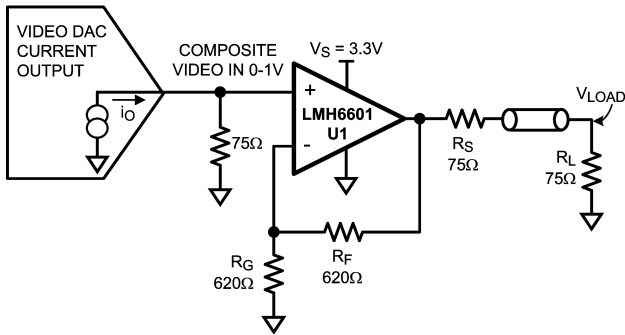

FIGURE 5. Single Supply Video Driver Capable of Maintaining Accurate Video Black Level

Application Information (Continued)

With the LMH6601 input common mode range including the V^- (ground) rail, there will be no need for AC coupling or level shifting and the input can directly drive the non-inverting input which has the additional advantage of high amplifier input impedance. With LMH6601's wide rail-to-rail output swing, as stated earlier, the video black level of 0V is maintained at the load with minimal circuit complexity and using no AC coupling capacitors. Without true rail-to-rail output swing of the LMH6601, and more importantly without the LMH6601's ability of exceedingly close swing to V^- , the circuit would not operate properly as shown at the expense of more complexity. This circuit will also work for higher input voltages. The only significant requirement is that there is at least 1.8V from the maximum input voltage to the positive supply (V^+).

The Composite Video Output of some low cost consumer video equipment consists of a current source which develops the video waveform across a load resistor (usually 75Ω), as shown in *Figure 6* below. With these applications, the same circuit configuration just described and shown in *Figure 6* will be able to buffer and drive the Composite Video waveform which includes sync and video combined. However, with this arrangement, the LMH6601 supply voltage needs to be at least 3.3V or higher in order to allow proper input common mode voltage headroom because the input can be as high as 1V peak.



20136445

FIGURE 6. Single Supply Composite Video Driver for Consumer Video Outputs

If the "Video In" signal is Composite Video with negative going Sync tip, a variation of the previous configurations should be used. This circuit produces a unipolar (above 0V) DC coupled single supply video signal as shown in *Figure 7*.

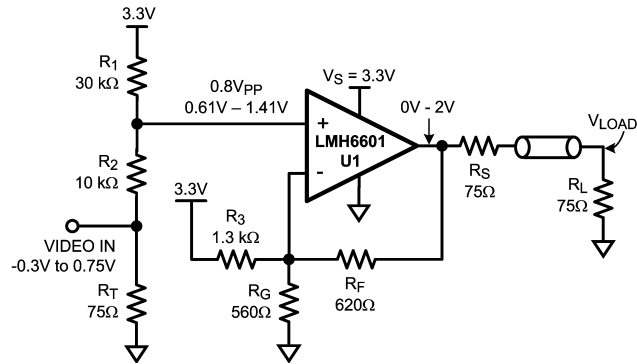

20136446

FIGURE 7. Single Supply DC Coupled Composite Video Driver for Negative Going Sync Tip

In the circuit of *Figure 7*, the input is shifted positive by means of R_1 , R_2 , and R_T in order to satisfy U1's Common Mode input range. The signal will lose 20% of its amplitude in the process. The closed loop gain of U1 will need to be set to make up for this 20% loss in amplitude. This gives rise to the gain expression shown below which is based on a getting a 2 V_{PP} output with a 0.8 V_{PP} input:

$$\frac{R_F}{R_G || R_3} = \frac{2V}{0.8V} - 1 = 1.5V/V \quad (1)$$

R_3 will produce a negative shift at the output due to V_S (3.3V in this case). R_3 will need to be set so that the "Video In" sync tip (-0.3V at R_T or 0.61V at U1 non-inverting input) corresponds to near 0V at the output.

$$\frac{R_F}{R_3} = \frac{0.61}{3.3V - 0.61} \left(1 + \frac{R_F}{R_G} \right) = 0.227 \left(1 + \frac{R_F}{R_G} \right) \quad (2)$$

Equation (1) and *Equation (2)* need to be solved simultaneously to arrive at the values of R_3 , R_F , and R_G which will satisfy both. From the datasheet, one can set $R_F = 620\Omega$ to be close to the recommended value for a gain of +2. It is easier to solve for R_G and R_3 by starting with a good estimate for one and iteratively solving *Equation (1)* and *Equation (2)* to arrive at the results. Here is one possible iteration cycle for reference:

Application Information (Continued)

$R_F = 620\Omega$

TABLE 1. Finding Figure 7 External Resistor Values by Iteration

Estimate R_G (Ω)	Calculated (from Equation (2)) R_3 (Ω)	Equation (1) LHS Calculated	Comment (Compare Equation (1) LHS Calculated to RHS)
1k	1.69k	0.988	Increase Equation (1) LHS by reducing R_G
820	1.56k	1.15	Increase Equation (1) LHS by reducing R_G
620	1.37k	1.45	Increase Equation (1) LHS by reducing R_G
390	239	4.18	Reduce Equation (1) LHS by increasing R_G
560	1.30k	1.59	Close to target value of 1.5V/V for Equation (1)

The final set of values for R_G and R_3 in Table 1 are values which will result in the proper gain and correct video levels (0V to 1V) at the output (V_{LOAD}).

AC COUPLED VIDEO

Many monitors and displays accept AC coupled inputs. This simplifies the amplification and buffering task in some respects. As can be seen in Figure 8, R_1 and R_2 simply set the input to the center of the input linear range while C_{IN} AC couples the video onto the op amp's input. The op amp is set for a closed loop gain of 2 with R_F and R_G . C_G is there to make sure the device output is also biased at mid-supply.

Because of the DC bias at the output, the load needs to be AC coupled as well through C_O . Some applications implement a small valued ceramic capacitor (not shown) in parallel with C_O which is electrolytic. The reason for this is that the ceramic capacitor will tend to shunt the inductive behavior of the Electrolytic capacitor at higher frequencies for an improved overall low impedance output.

C_{G2} is intended to boost the high frequency gain in order to improve the video frequency response. This value is to be set and trimmed on the board to meet the application's specific system requirements.

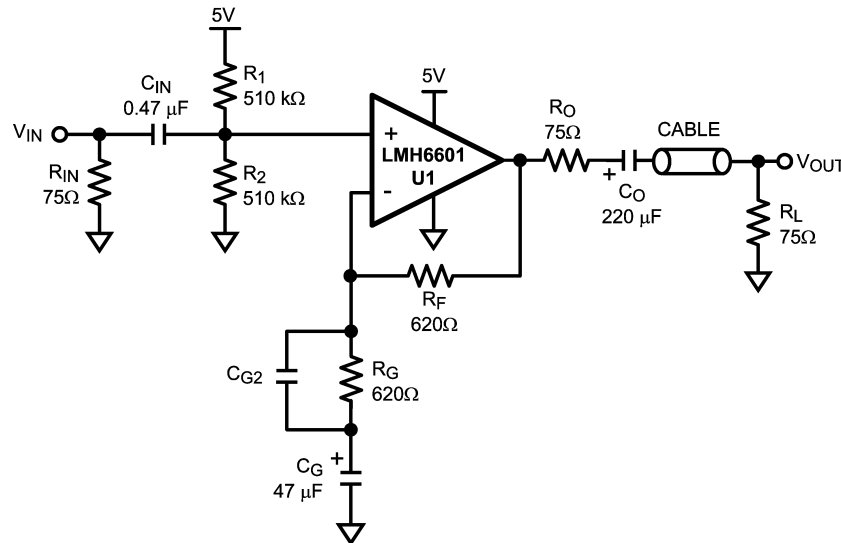

20136449

FIGURE 8. AC Coupled Video Amplifier/Driver

SAG COMPENSATION

The capacitors shown in Figure 8 (except C_{G2}), and especially C_O , are the large electrolytic type which are considerably costly and take up valuable real estate on the board. It is possible to reduce the value of the output coupling capacitor, C_O , which is the largest of all, by using what is called SAG compensation. SAG refers to what the output video experiences due to the low frequency video content it contains which cannot adequately go through the output AC

coupling scheme due to the low frequency limit of this circuit. The -3 dB low frequency limit of the output circuit is given by:

$$f_{\text{low_frequency}} (-3 \text{ dB}) = 1 / (2\pi * 75 * 2(\Omega) * C_O) = \sim 4.82 \text{ Hz For } C_O = 220 \mu\text{F} \quad (3)$$

A possible implementation of the SAG compensation is shown in Figure 9.

Application Information (Continued)

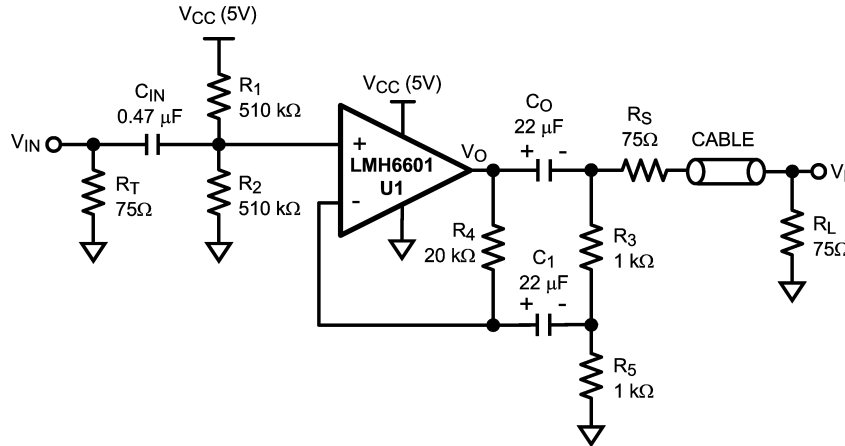

20136450

FIGURE 9. AC Coupled Video Amplifier/Driver with SAG Compensation

In this circuit, the output coupling capacitor value and size is greatly reduced at the expense of slightly higher op amp output voltage drive. Note that C_1 is not only part of the SAG compensation, but it also sets the amplifier's DC gain to 0 dB so that the output is set to mid-rail for linearity purposes. Also note that exceptionally high values are chosen for the R_1 and R_2 biasing resistors (510 kΩ). The LMH6601 has extremely low input bias current which allows this selection thereby reducing the C_{IN} value in this circuit such that C_{IN} can even be a non-polar capacitors which will reduce cost.

At high enough frequencies where both C_O and C_1 can be considered to be shorted out, R_3 shunts R_4 and the closed loop gain is determined by:

$$\text{Closed_loop_Gain (V/V)} = V_L/V_{IN} = (1 + (R_3 \parallel R_4) / R_5) [R_L / (R_L + R_O)] = 1V/V \quad (4)$$

At intermediate frequencies, where the C_O , R_O , R_L path experiences low frequency gain loss, the R_3 , R_5 , C_1 path provides feedback from the load side of C_O . With the load side gain reduced at these lower frequencies, the feedback to the op amp inverting node reduces, causing an increase at the op amp's output as a response.

For NTSC video, low values of C_O influence how much video black level shift occurs during the vertical blanking interval (~1.5 ms) which has no video activity and thus is sensitive to C_O 's charge dissipation through the load which could cause output SAG. An especially tough pattern is the NTSC pattern called "Pulse & Bar." With this pattern the entire top and bottom portion of the field is black level video where for about 8.5 ms C_O is discharging through the load with no video activity to replenish that charge.

Figure 10 shows the output of the Figure 9 circuit with the scope's cursors pointing to the SAG.

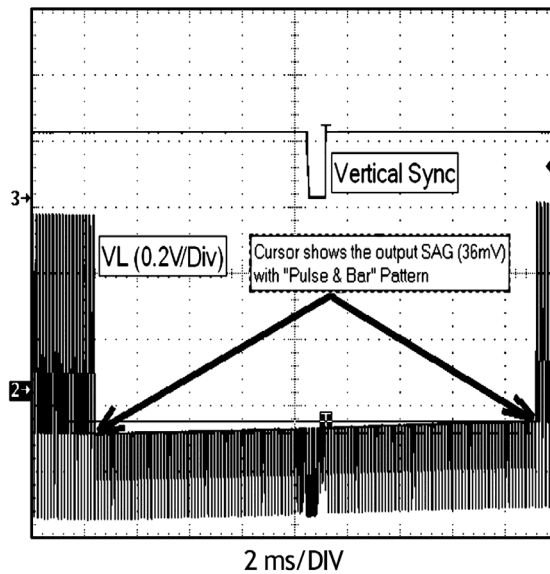

20136451

FIGURE 10. Figure 9 Scope Photo Showing Video SAG

There is a subtlety with the additional output drive in the SAG correction circuit, compared to a circuit with no SAG compensation, especially when using lower power supply voltages. This will be explained later after a brief introduction, below, on the effects of AC coupling on output swing.

With the circuit of Figure 9 and any other AC coupled pulse amplifier, the waveform duty cycle variations exert additional restrictions on voltage swing at any node. This is illustrated in the waveforms shown in Figure 11.

Application Information (Continued)

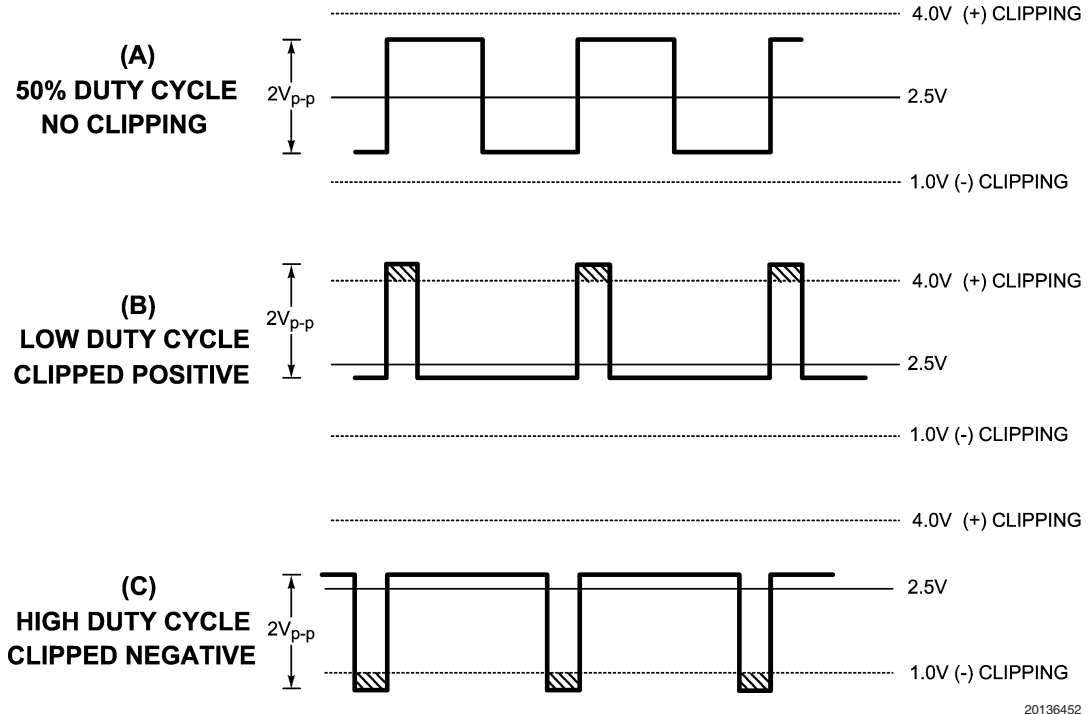

FIGURE 11. Headroom Considerations with AC Coupled Amplifiers

If a stage has a 3 V_{PP} unclipped swing available at a given node, as shown in Figure 11, the maximum allowable amplitude for an arbitrary waveform is 1/2 of 3V or 1.5 V_{PP}. This is due to the shift in the average value of the waveform as the duty cycle varies. Figure 11 shows what would happen if a 2 V_{PP} signal were applied. A low duty cycle waveform, such as the one in Figure 11B, would have high positive excursions. At low enough duty cycles, the waveform could get clipped on the top, as shown, or a more subtle loss of linearity could occur prior to full-blown clipping. The converse of this occurs with high duty cycle waveforms and negative clipping, as depicted in Figure 11C.

Now, let's get back to discussing the SAG compensation output swing subtlety hinted at earlier. For the Figure 9 circuit, with a 1 V_{PP} Composite Video input, the op amp output will swing 2 V_{PP} because the stage gain is set to 2 V/V. With the output set to V_{CC}/2 (2.5V in this case), the op amp output voltage will range from 0.5V to 4.5V, assuming video duty cycle variation of 100% to 0% respectively. In reality, the duty cycle only approaches these extreme end points and it never quite gets there. Figure 12 shows the measured response of this circuit to show the worst case swing at the op amp output pin. Note that the extra output drive at the op amp output for SAG compensation, which shows up as a tilt in the upper video waveform, could cause clipping as the output swings even closer to the rails.

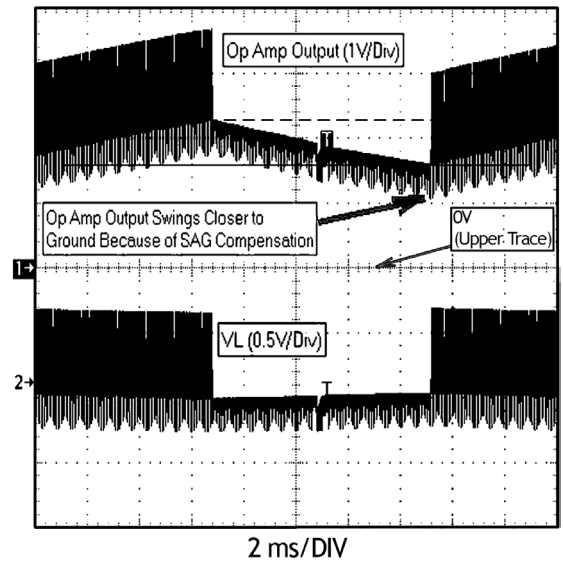

FIGURE 12. SAG Compensation Requires Higher Swing at op amp Output

Application Information (Continued)

HOW TO PICK THE RIGHT VIDEO AMPLIFIER

Apart from output current drive and voltage swing, the op amp used for a video amplifier/cable driver should also possess the minimum requirement for speed and slew rate. For video type loads, it is best to consider Large Signal Bandwidth (or LSBW in the National Semiconductor data

sheet tables) as video signals could be as large as $2 V_{PP}$ when applied to the commonly used gain of +2 configuration. Because of this relatively large swing, the op amp Slew Rate (SR) limitation should also be considered. *Table 2* shows these requirements for various video line rates calculated using a rudimentary technique and intended as a first order estimate only.

TABLE 2. Rise Time, -3 dB BW, and Slew Rate Requirements for Various Video Line Rates

Video Standard	Line Rate (HxV)	Refresh Rate (Hz)	Horizontal Active (KH%)	Vertical Active (KV%)	Pixel Time (ns)	Rise Time (ns)	LSBW (MHz)	SR (V/μs)
TV_NTSC	451x483	30	84	92	118.3	39.4	9	41
VGA	640x480	75	80	95	33.0	11.0	32	146
SVGA	800x600	75	76	96	20.3	6.8	52	237
XGA	1024x768	75	77	95	12.4	4.1	85	387
SXGA	1280x1024	75	75	96	7.3	2.4	143	655
UXGA	1600x1200	75	74	96	4.9	1.6	213	973

For any video line rate (HxV corresponding to the number of Active horizontal and vertical lines), the speed requirements can be estimated if the Horizontal Active (KH%) and Vertical Active (KV%) numbers are known. These percentages correspond to the percentages of the active number of lines (horizontal or vertical) to the total number of lines as set by VESA standards. Here are the general expressions and the specific calculations for the SVGA line rate shown in *Table 2*.

$$\text{PIXEL_TIME (ns)} = \frac{1}{\text{REFRESH_RATE}} \times \text{KH} \times \text{KV} \times 1 \times 10^5$$

$$= \frac{1}{75 \text{ Hz}} \times 76 \times 96 \times 1 \times 10^5 = 20.3 \text{ ns} \quad (5)$$

Requiring that an "On" pixel is illuminated to at least 90% of its final value before changing state will result in the rise/fall time equal to, at most, 1/3 the pixel time as shown below:

$$\text{RISE/FALL_TIME} = \frac{\text{PIXEL_TIME}}{3} = \frac{20.3 \text{ ns}}{3} = 6.8 \text{ ns} \quad (6)$$

Assuming a single pole frequency response roll-off characteristic for the closed loop amplifier used, we have:

$$-3 \text{ dB_BW} = \frac{0.35}{\text{RISE/FALL_TIME}} = \frac{0.35}{6.8 \text{ ns}} = 52 \text{ MHz} \quad (7)$$

Rise/Fall times are 10%-90% transition times, which for a $2 V_{PP}$ video step would correspond to a total voltage shift of 1.6V (80% of 2V). So, the Slew Rate requirement can be calculated as follows:

$$\text{SR (V/μs)} = \frac{1.6 \text{ V}}{\text{RISE/FALL_TIME (ns)}} \times 1 \times 10^3 = \frac{1.6 \text{ V}}{6.8 \text{ ns}} = 237 \text{ (V/μs)} \quad (8)$$

The LMH6601 specifications show that it would be a suitable choice for video amplifiers up to and including the SVGA line rate as demonstrated above.

For more information about this topic and others relating to video amplifiers, please see Application Note 1013:

<http://www.national.com/an/AN/AN-1013.pdf#page=1>

CURRENT TO VOLTAGE CONVERSION (TRANSIMPEDANCE AMPLIFIER (TIA))

Being capable of high speed and having ultra low input bias current makes the LMH6601 a natural choice for Current to Voltage applications such as photodiode I-V conversion. In these type of applications, as shown in *Figure 13* below, the photodiode is tied to the inverting input of the amplifier with R_F set to the proper gain (gain is measured in Ohms).

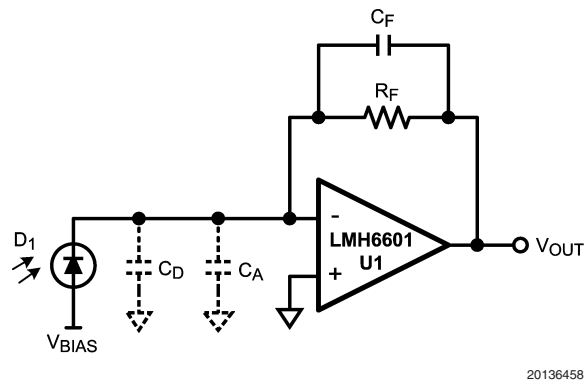

FIGURE 13. Typical Connection of a Photodiode Detector to an op amp

Application Information (Continued)

With the LMH6601 input bias current in the femto-amperes range, even large values of gain (R_F) do not increase the output error term appreciably. This allows circuit operation to a lower light intensity level which is always of special importance in these applications. Most photo-diodes have a relatively large capacitance (C_D) which would be even larger for a photo-diode designed for higher sensitivity to light because of its larger area. Some applications may run the photodiode with a reverse bias in order to reduce its capacitance with the disadvantage of increased contributions from both dark current and noise current. *Figure 14* shows a typical photodiode capacitance plot vs. reverse bias for reference.

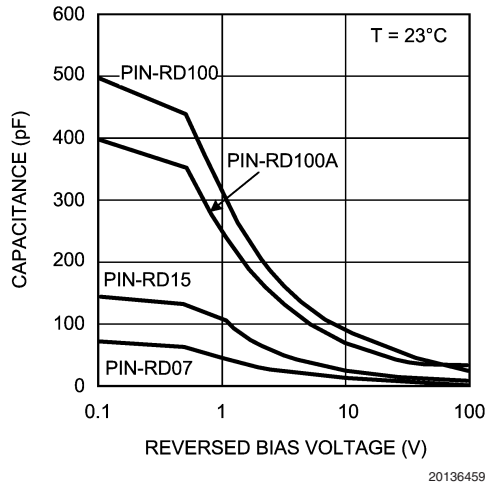

FIGURE 14. Typical Capacitance vs. Reverse Bias
(Source: OSI Optoelectronics)

The diode capacitance (C_D) along with the input capacitance of the LMH6601 (C_A) has a bearing on the stability of this circuit and how it is compensated. With large transimpedance gain values (R_F), the total combined capacitance on the amplifier inverting input ($C_{IN} = C_D + C_A$) will work against R_F to create a zero in the Noise Gain (NG) function (see *Figure 15*). If left untreated, at higher frequencies where NG equals the open loop transfer function there will be excess phase shift around the loop (approaching 180°) and therefore, the circuit could be unstable. This is illustrated in *Figure 15*.

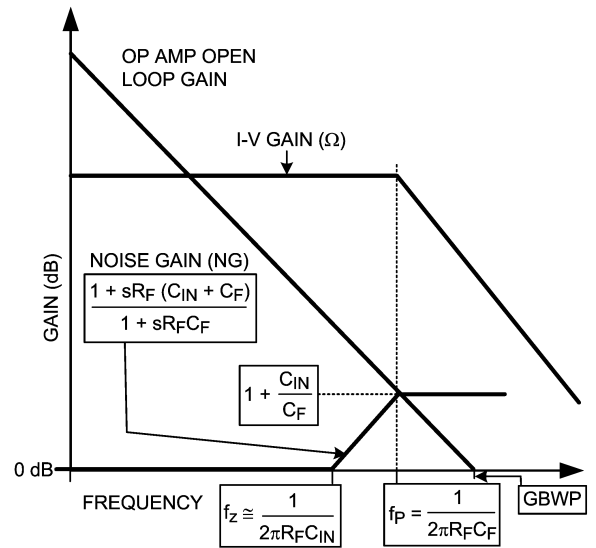

FIGURE 15. Transimpedance Amplifier Graphical Stability Analysis and Compensation

Figure 15 shows that placing a capacitor, C_F , with the proper value, across R_F will create a pole in the NG function at f_p . For optimum performance, this capacitor is usually picked so that NG is equal to the op amp's open loop gain at f_p . This will cause a "flattening" of the NG slope beyond the point of intercept of two plots (open loop gain and NG) and will result in a Phase Margin (PM) of 45° assuming f_p and f_z are at least a decade apart. This is because at the point of intercept, the NG pole at f_p will have a 45° phase lead contribution which leaves 45° of PM. For reference, *Figure 15* also shows the transimpedance gain (I-V (Ω))

Here is the theoretical expression for the optimum C_F value and the expected -3 dB bandwidth:

$$C_F = \sqrt{\frac{C_{IN}}{2\pi(GBWP)R_F}} \tag{9}$$

$$f_{-3\text{ dB}} \cong \sqrt{\frac{GBWP}{2\pi R_F C_{IN}}} \tag{10}$$

Table 3, below, lists the results, along with the assumptions and conditions, of testing the LMH6601 with various photodiodes having different capacitances (C_D) at a transimpedance gain (R_F) of $10\text{ k}\Omega$.

Application Information (Continued)

TABLE 3. Transimpedance Amplifier Figure 13 Compensation and Performance Results

C_D (pF)	C_{IN} (pF)	$C_{F_Calculated}$ (pF)	C_F used (pF)	-3 dB BW Calculated (MHz)	-3 dB BW Measured (MHz)	Step Response Overshoot (%)
10	12	1.1	1	14	15	6
50	52	2.3	3	7	7.0	4
500	502	7.2	8	2	2.5	9

$$C_A = 2 \text{ pF}$$

$$GBWP = 155 \text{ MHz}$$

$$V_S = 5V$$

TRANSIMPEDANCE AMPLIFIER NOISE CONSIDERATIONS

When analyzing the noise at the output of the I-V converter, it is important to note that the various noise sources (i.e. op amp noise voltage, feedback resistor thermal noise, input noise current, photodiode noise current) do not all operate over the same frequency band. Therefore, when the noise at the output is calculated, this should be taken into account.

The op amp noise voltage will be gained up in the region between the noise gain's "zero" and its "pole" (f_z and f_p in Figure 15). The higher the values of R_F and C_{IN} , the sooner the noise gain peaking starts and therefore its contribution to the total output noise would be larger. It is obvious to note that it is advantageous to minimize C_{IN} (e.g. by proper choice of op amp, by applying a reverse bias across the diode at the expense of excess dark current and noise). However, most low noise op amps have a higher input capacitance compared to ordinary op amps. This is due to the low noise op amp's larger input stage.

OTHER APPLICATIONS

$$R_F = 10 \text{ M}\Omega \text{ to } 10 \text{ G}\Omega$$

$$R_S = 1 \text{ M}\Omega \text{ or SMALLER FOR HIGH COUNTING RATES}$$

$$C_F = 1 \text{ pF}$$

$$C_D = 1 \text{ pF to } 10 \text{ }\mu\text{F}$$

$$V_{OUT} = Q/C_F \text{ WHERE } Q \text{ is CHARGE}$$

$$\text{CREATED BY ONE PHOTON or PARTICLE}$$

$$\text{ADJUST } V_{BIAS} \text{ FOR MAXIMUM SNR}$$

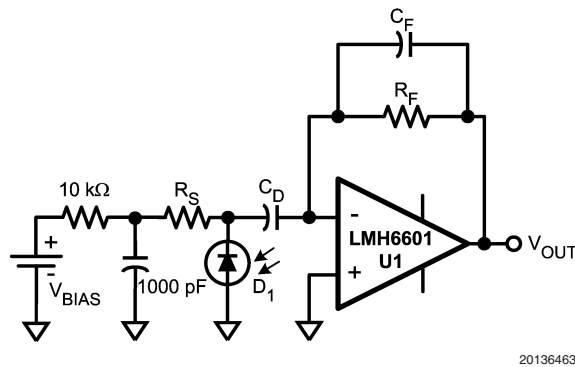

FIGURE 16. Charge Preamplifier Taking Advantage of LMH6601's Femto-Ampere Range Input Bias Current

CAPACITIVE LOAD

The LMH6601 can drive a capacitive load of up to 1000 pF with correct isolation and compensation. Figure 17 illustrates the in-loop compensation technique to drive a large capacitive load.

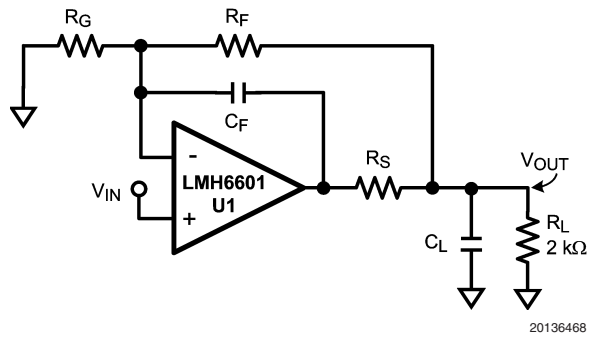

FIGURE 17. In-Loop Compensation Circuit for Driving a Heavy Capacitive Load

When driving a high capacitive load, an isolation resistor (R_S) should be connected in series between the op amp output and the capacitive load to provide isolation and to avoid oscillations. A small value capacitor (C_F) is inserted between the op amp output and the inverting input as shown such that this capacitor becomes the dominant feedback path at higher frequency. Together these components allow heavy capacitive loading while keeping the loop stable.

There are few factors which affect the driving capability of the op amp:

- Op amp internal architecture
- Closed loop gain and output capacitor loading

Table 4 shows the measured step response for various values of load capacitors (C_L), series resistor (R_S) and feedback resistor (C_F) with gain of +2 ($R_F = R_G = 604\Omega$) and $R_L = 2 \text{ k}\Omega$:

TABLE 4. LMH6601 Step Response Summary for the Circuit of Figure 17

C_L (pF)	R_S (Ω)	C_F (pF)	t_{rise}/t_{fall} (ns)	Overshoot (%)
10	0	1	6*	8
50	0	1	7*	6
110	47	1	10	16
300	6	10	12	20
500	80	10	33	10
910	192	10	65	10

* Response limited by input step generator rise time of 5 ns

Application Information (Continued)

Figure 18 shows the increase in rise/fall time (bandwidth decrease) at V_{OUT} with larger capacitive loads, illustrating the trade-off between the two:

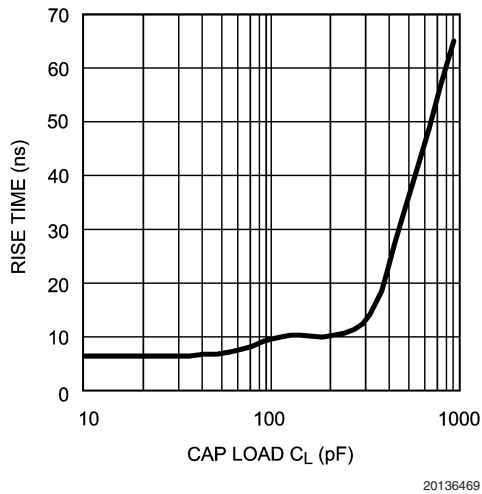

FIGURE 18. LMH6601 In-Loop Compensation Response

EVALUATION BOARD

National Semiconductor provides the following evaluation board as a guide for high frequency layout and as an aid in device testing and characterization. Many of the datasheet plots were measured with this board:

Device	Package	Board Part #
LMH6601MG	SC70-6	LMH730165

This evaluation board can be shipped when a device sample request is placed with National Semiconductor.

Physical Dimensions inches (millimeters) unless otherwise noted

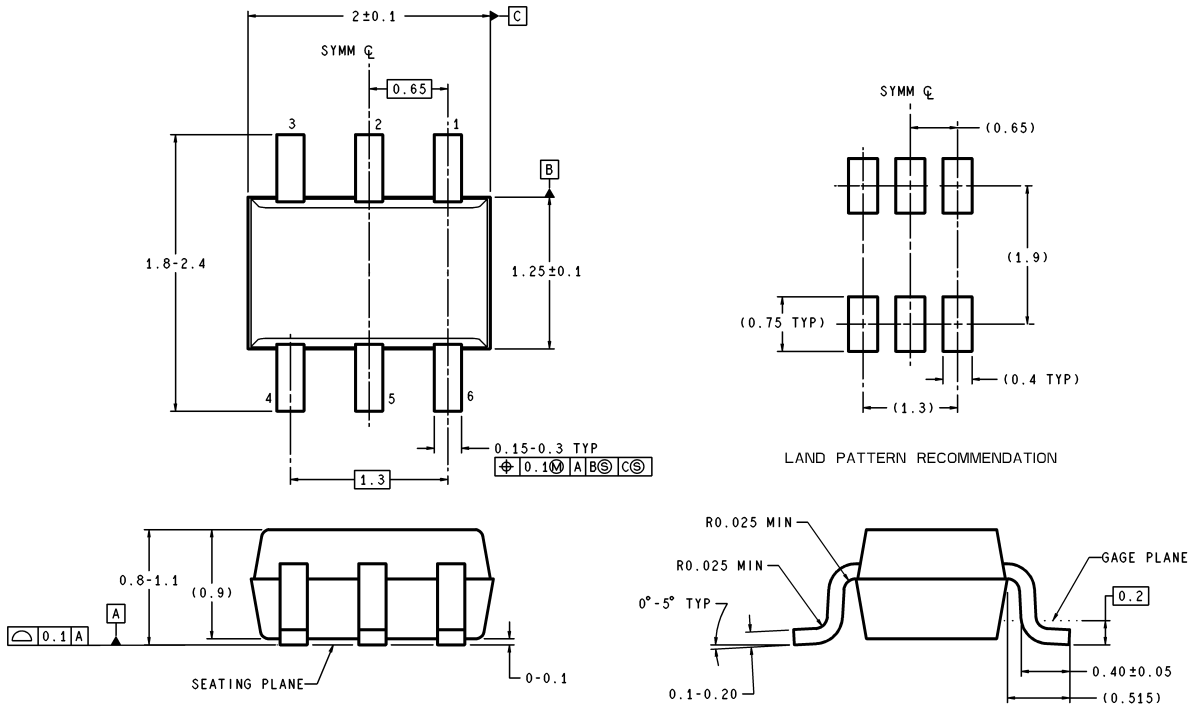

DIMENSIONS ARE IN MILLIMETERS

MAA06A (Rev A)

**6-Pin SC70
NS Package Number MA006A**

National does not assume any responsibility for use of any circuitry described, no circuit patent licenses are implied and National reserves the right at any time without notice to change said circuitry and specifications.

For the most current product information visit us at www.national.com.

LIFE SUPPORT POLICY

NATIONAL'S PRODUCTS ARE NOT AUTHORIZED FOR USE AS CRITICAL COMPONENTS IN LIFE SUPPORT DEVICES OR SYSTEMS WITHOUT THE EXPRESS WRITTEN APPROVAL OF THE PRESIDENT AND GENERAL COUNSEL OF NATIONAL SEMICONDUCTOR CORPORATION. As used herein:

1. Life support devices or systems are devices or systems which, (a) are intended for surgical implant into the body, or (b) support or sustain life, and whose failure to perform when properly used in accordance with instructions for use provided in the labeling, can be reasonably expected to result in a significant injury to the user.
2. A critical component is any component of a life support device or system whose failure to perform can be reasonably expected to cause the failure of the life support device or system, or to affect its safety or effectiveness.

BANNED SUBSTANCE COMPLIANCE

National Semiconductor follows the provisions of the Product Stewardship Guide for Customers (CSP-9-111C2) and Banned Substances and Materials of Interest Specification (CSP-9-111S2) for regulatory environmental compliance. Details may be found at: www.national.com/quality/green.

Lead free products are RoHS compliant.



National Semiconductor
Americas Customer
Support Center
Email: new.feedback@nsc.com
Tel: 1-800-272-9959

National Semiconductor
Europe Customer Support Center
Fax: +49 (0) 180-530 85 86
Email: europe.support@nsc.com
Deutsch Tel: +49 (0) 69 9508 6208
English Tel: +44 (0) 870 24 0 2171
Français Tel: +33 (0) 1 41 91 8790

National Semiconductor
Asia Pacific Customer
Support Center
Email: ap.support@nsc.com

National Semiconductor
Japan Customer Support Center
Fax: 81-3-5639-7507
Email: jpn.feedback@nsc.com
Tel: 81-3-5639-7560

www.national.com