



### FEATURES

- 2.5 kV rms signal and power isolated CAN transceiver
- isoPower integrated isolated dc-to-dc converter
- 5 V operation on  $V_{CC}$
- 5 V or 3.3 V operation on  $V_{IO}$
- Complies with ISO 11898 standard
- High speed data rates of up to 1 Mbps
- Unpowered nodes do not disturb the bus
- Connect 110 or more nodes on the bus
- Slope control for reduced EMI
- Thermal shutdown protection
- High common-mode transient immunity: >25 kV/ $\mu$ s
- Safety and regulatory approvals
  - UL recognition
    - 2500 V rms for 1 minute per UL 1577
  - VDE Certificate of Conformity
    - DIN EN 60747-5-2 (VDE 0884 Part 2): 2003-01
    - $V_{IORM} = 560$  V peak
- Industrial operating temperature range ( $-40^{\circ}\text{C}$  to  $+85^{\circ}\text{C}$ )
- Available in wide-body, 20-lead SOIC package

### APPLICATIONS

- CAN data buses
- Industrial field networks

### GENERAL DESCRIPTION

The ADM3053 is an isolated controller area network (CAN) physical layer transceiver with an integrated isolated dc-to-dc converter. The ADM3053 complies with the ISO 11898 standard.

The device employs Analog Devices, Inc., iCoupler® technology to combine a 2-channel isolator, a CAN transceiver, and Analog Devices isoPower® dc-to-dc converter into a single SOIC surface mount package. An on-chip oscillator outputs a pair of square waveforms that drive an internal transformer to provide isolated power. The device is powered by a single 5 V supply realizing a fully isolated CAN solution.

The ADM3053 creates a fully isolated interface between the CAN protocol controller and the physical layer bus. It is capable of running at data rates of up to 1 Mbps.

The device has current limiting and thermal shutdown features to protect against output short circuits. The part is fully specified over the industrial temperature range and is available in a 20-lead, wide-body SOIC package.

The ADM3053 contains isoPower technology that uses high frequency switching elements to transfer power through the transformer. Special care must be taken during printed circuit board (PCB) layout to meet emissions standards. Refer to the AN-0971 Application Note, Control of Radiated Emissions with isoPower Devices, for details on board layout considerations.

### FUNCTIONAL BLOCK DIAGRAM

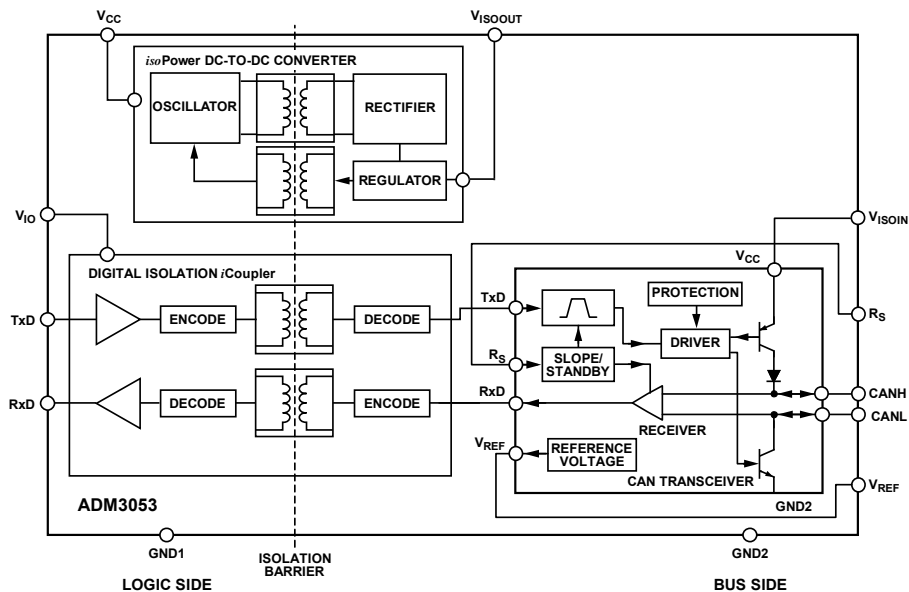

Figure 1.

#### Rev. A

Information furnished by Analog Devices is believed to be accurate and reliable. However, no responsibility is assumed by Analog Devices for its use, nor for any infringements of patents or other rights of third parties that may result from its use. Specifications subject to change without notice. No license is granted by implication or otherwise under any patent or patent rights of Analog Devices. Trademarks and registered trademarks are the property of their respective owners.

One Technology Way, P.O. Box 9106, Norwood, MA 02062-9106, U.S.A.  
 Tel: 781.329.4700 [www.analog.com](http://www.analog.com)  
 Fax: 781.461.3113 ©2011–2012 Analog Devices, Inc. All rights reserved.

## TABLE OF CONTENTS

Features .....	1	Test Circuits.....	12
Applications.....	1	Circuit Description.....	13
General Description .....	1	CAN Transceiver Operation .....	13
Functional Block Diagram .....	1	Signal Isolation .....	13
Revision History .....	2	Power Isolation .....	13
Specifications.....	3	Truth Tables.....	13
Timing Specifications .....	4	Thermal Shutdown .....	13
Switching Characteristics .....	4	DC Correctness and Magnetic Field Immunity.....	13
Regulatory Information.....	5	Applications Information .....	15
Insulation and Safety-Related Specifications.....	5	PCB Layout .....	15
VDE 0884 Insulation Characteristics .....	6	EMI Considerations .....	15
Absolute Maximum Ratings.....	7	Insulation Lifetime .....	15
ESD Caution.....	7	Typical Applications.....	17
Pin Configuration and Function Descriptions.....	8	Outline Dimensions .....	18
Typical Performance Characteristics .....	9	Ordering Guide .....	18

## REVISION HISTORY

### 3/12—Rev. 0 to Rev. A

Changes to Features Section.....	1
Changes to Table 3.....	5
Changes to VDE 0884 Insulation Characteristics Section.....	6
Changes to Figure 6.....	9
Changes to Figure 11.....	10
Changes to Applications Information Section.....	15

### 5/11—Revision 0: Initial Version

## SPECIFICATIONS

All voltages are relative to their respective ground;  $4.5\text{ V} \leq V_{CC} \leq 5.5\text{ V}$ ;  $3.0\text{ V} \leq V_{IO} \leq 5.5\text{ V}$ . All minimum/maximum specifications apply over the entire recommended operation range, unless otherwise noted. All typical specifications are at  $T_A = 25^\circ\text{C}$ ,  $V_{CC} = 5\text{ V}$ ,  $V_{IO} = 5\text{ V}$  unless otherwise noted.

Table 1.

Parameter	Symbol	Min	Typ	Max	Unit	Test Conditions
<b>SUPPLY CURRENT</b>						
Logic Side <i>iso</i> Power Current						
Recessive State	$I_{CC}$		29	36	mA	$R_L = 60\ \Omega$ , $R_S = \text{low}$ , see Figure 25
Dominant State	$I_{CC}$		195	232	mA	$R_L = 60\ \Omega$ , $R_S = \text{low}$ , see Figure 25
TxD/RxD Data Rate 1 Mbps	$I_{CC}$		139	170	mA	$R_L = 60\ \Omega$ , $R_S = \text{low}$ , see Figure 25
Logic Side <i>i</i> Coupler Current						
TxD/RxD Data Rate 1 Mbps	$I_{IO}$		1.6	2.5	mA	
<b>DRIVER</b>						
Logic Inputs						
Input Voltage High	$V_{IH}$	0.7 $V_{IO}$			V	Output recessive
Input Voltage Low	$V_{IL}$			0.25 $V_{IO}$	V	Output dominant
CMOS Logic Input Currents	$I_{IH}, I_{IL}$			500	$\mu\text{A}$	TxD
Differential Outputs						
Recessive Bus Voltage	$V_{CANL}, V_{CANH}$	2.0		3.0	V	TxD = high, $R_L = \infty$ , see Figure 22
CANH Output Voltage	$V_{CANH}$	2.75		4.5	V	TxD = low, see Figure 22
CANL Output Voltage	$V_{CANL}$	0.5		2.0	V	TxD = low, see Figure 22
Differential Output Voltage	$V_{OD}$	1.5		3.0	V	TxD = low, $R_L = 45\ \Omega$ , see Figure 22
Short-Circuit Current, CANH	$I_{SCCANH}$			+50	mV	TxD = high, $R_L = \infty$ , see Figure 22
Short-Circuit Current, CANL	$I_{SCCANL}$		-100	-200	mA	$V_{CANH} = -5\text{ V}$
					mA	$V_{CANH} = -36\text{ V}$
				200	mA	$V_{CANL} = 36\text{ V}$
<b>RECEIVER</b>						
Differential Inputs						
Differential Input Voltage Recessive	$V_{IDR}$	-1.0		+0.5	V	$-7\text{ V} < V_{CANL}, V_{CANH} < +12\text{ V}$ , see Figure 23, $C_L = 15\text{ pF}$
Differential Input Voltage Dominant	$V_{IDD}$	0.9		5.0	V	$-7\text{ V} < V_{CANL}, V_{CANH} < +12\text{ V}$ , see Figure 23, $C_L = 15\text{ pF}$
Input Voltage Hysteresis	$V_{HYS}$		150		mV	See Figure 3
CANH, CANL Input Resistance	$R_{IN}$	5		25	k $\Omega$	
Differential Input Resistance	$R_{DIFF}$	20		100	k $\Omega$	
Logic Outputs						
Output Low Voltage	$V_{OL}$		0.2	0.4	V	$I_{OUT} = 1.5\text{ mA}$
Output High Voltage	$V_{OH}$	$V_{IO} - 0.3$	$V_{IO} - 0.2$		V	$I_{OUT} = -1.5\text{ mA}$
Short Circuit Current	$I_{OS}$	7		85	mA	$V_{OUT} = \text{GND1 or } V_{IO}$
<b>VOLTAGE REFERENCE</b>						
Reference Output Voltage	$V_{REF}$	2.025		3.025	V	$ I_{REF}  = 50\ \mu\text{A}$
<b>COMMON-MODE TRANSIENT IMMUNITY<sup>1</sup></b>						
		25			kV/ $\mu\text{s}$	$V_{CM} = 1\text{ kV}$ , transient magnitude = 800 V
<b>SLOPE CONTROL</b>						
Current for Slope Control Mode	$I_{SLOPE}$	-10		-200	$\mu\text{A}$	
Slope Control Mode Voltage	$V_{SLOPE}$	1.8		3.3	V	

<sup>1</sup> CM is the maximum common-mode voltage slew rate that can be sustained while maintaining specification-compliant operation. VCM is the common-mode potential difference between the logic and bus sides. The transient magnitude is the range over which the common mode is slewed. The common-mode voltage slew rates apply to both rising and falling common-mode voltage edges.

**TIMING SPECIFICATIONS**

All voltages are relative to their respective ground;  $3.0\text{ V} \leq V_{IO} \leq 5.5\text{ V}$ ;  $4.5\text{ V} \leq V_{CC} \leq 5.5\text{ V}$ .  $T_A = -40^\circ\text{C}$  to  $+85^\circ\text{C}$ , unless otherwise noted.

Table 2.

Parameter	Symbol	Min	Typ	Max	Unit	Test Conditions
<b>DRIVER</b>						
Maximum Data Rate		1			Mbps	
Propagation Delay from TxD On to Bus Active	$t_{onTxD}$			90	ns	$R_S = 0\ \Omega$ ; see Figure 2 and Figure 24 $R_L = 60\ \Omega$ , $C_L = 100\ \text{pF}$
Propagation Delay from TxD Off to Bus Inactive	$t_{offTxD}$			120	ns	$R_S = 0\ \Omega$ ; see Figure 2 and Figure 24 $R_L = 60\ \Omega$ , $C_L = 100\ \text{pF}$
<b>RECEIVER</b>						
Propagation Delay from TxD On to Receiver Active	$t_{onRxD}$			200	ns	$R_S = 0\ \Omega$ ; see Figure 2
				630	ns	$R_S = 47\ \text{k}\Omega$ ; see Figure 2
Propagation Delay from TxD Off to Receiver Inactive <sup>1</sup>	$t_{offRxD}$			250	ns	$R_S = 0\ \Omega$ ; see Figure 2
				480	ns	$R_S = 47\ \text{k}\Omega$ ; see Figure 2
<b>CANH, CANL SLEW RATE</b>						
	SR		7		V/ $\mu\text{s}$	$R_S = 47\ \text{k}\Omega$

<sup>1</sup> Guaranteed by design and characterization.

**SWITCHING CHARACTERISTICS**

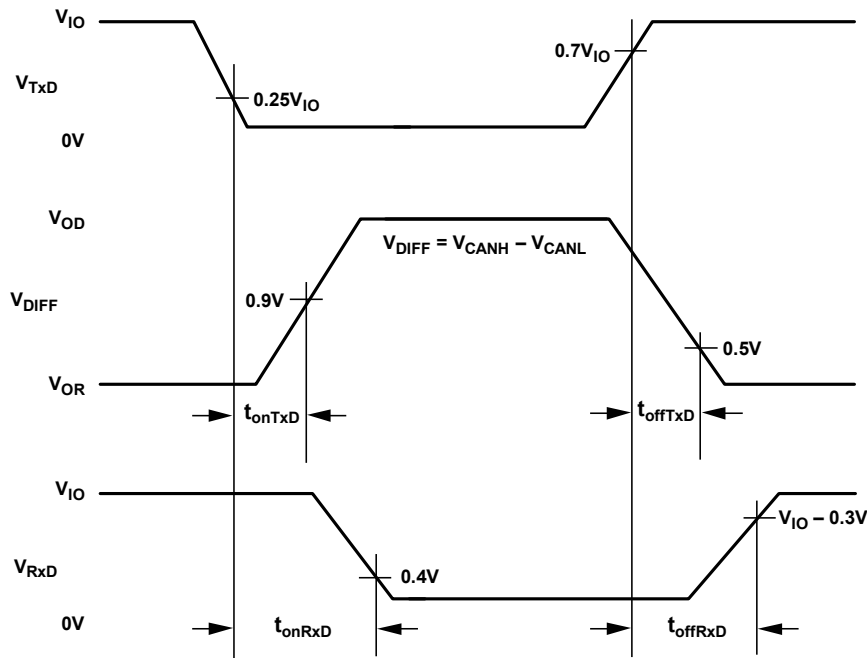

Figure 2. Driver Propagation Delay, Rise/Fall Timing

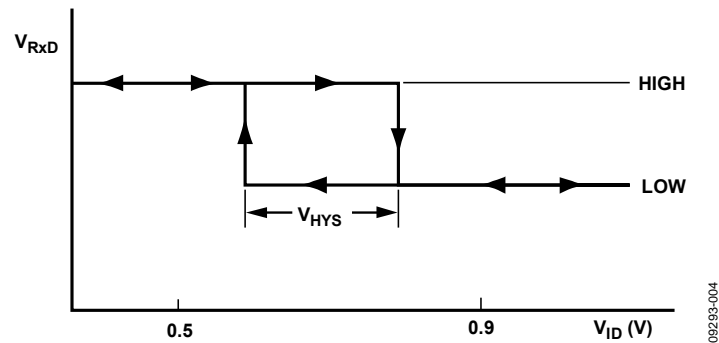

Figure 3. Receiver Input Hysteresis

## REGULATORY INFORMATION

Table 3. ADM3053 Approvals

Organization	Approval Type	Notes
UL	Recognized under the Component Recognition Program of Underwriters Laboratories, Inc.	In accordance with UL 1577, each ADM3053 is proof tested by applying an insulation test voltage $\geq 2500$ V rms for 1 second. File E214100.
VDE	Certified according to DIN EN 60747-5-2 (VDE 0884 Part 2): 2003-01	In accordance with VDE 0884-2. File 2471900-4880-0001.

## INSULATION AND SAFETY-RELATED SPECIFICATIONS

Table 4.

Parameter	Symbol	Value	Unit	Conditions
Rated Dielectric Insulation Voltage		2500	V rms	1-minute duration
Minimum External Air Gap (Clearance)	L(I01)	7.7	mm	Measured from input terminals to output terminals, shortest distance through air
Minimum External Tracking (Creepage)	L(I02)	7.6	mm	Measured from input terminals to output terminals, shortest distance along body
Minimum Internal Gap (Internal Clearance)		0.017 min	mm	Insulation distance through insulation
Tracking Resistance (Comparative Tracking Index)	CTI	>175	V	DIN IEC 112/VDE 0303-1
Isolation Group		IIIa		Material group (DIN VDE 0110: 1989-01, Table 1)

**VDE 0884 INSULATION CHARACTERISTICS**

This isolator is suitable for basic electrical isolation only within the safety limit data. Maintenance of the safety data must be ensured by means of protective circuits.

**Table 5.**

Description	Conditions	Symbol	Characteristic	Unit
CLASSIFICATIONS				
Installation Classification per DIN VDE 0110 for Rated Mains Voltage			I to IV	
≤150 V rms			I to III	
≤300 V rms			I to II	
≤400 V rms			40/85/21	
Climatic Classification			2	
Pollution Degree	DIN VDE 0110, see Table 3			
VOLTAGE				
Maximum Working Insulation Voltage		$V_{IORM}$	560	$V_{PEAK}$
Input-to-Output Test Voltage		$V_{PR}$	1050	$V_{PEAK}$
Method b1	$V_{IORM} \times 1.875 = V_{PR}$ , 100% production tested, $t_m = 1$ sec, partial discharge < 5 pC			
Highest Allowable Overvoltage	(Transient overvoltage, $t_{TR} = 10$ sec)	$V_{TR}$	4000	$V_{PEAK}$
SAFETY-LIMITING VALUES	Maximum value allowed in the event of a failure			
Case Temperature		$T_S$	150	°C
Input Current		$I_{S, INPUT}$	265	mA
Output Current		$I_{S, OUTPUT}$	335	mA
Insulation Resistance at $T_S$	$V_{IO} = 500$ V	$R_S$	$>10^9$	$\Omega$

## ABSOLUTE MAXIMUM RATINGS

$T_A = 25^\circ\text{C}$ , unless otherwise noted. All voltages are relative to their respective ground.

**Table 6.**

Parameter	Rating
$V_{CC}$	-0.5 V to +6 V
$V_{IO}$	-0.5 V to +6 V
Digital Input Voltage, TxD	-0.5 V to $V_{IO} + 0.5$ V
Digital Output Voltage, RxD	-0.5 V to $V_{IO} + 0.5$ V
CANH, CANL	-36 V to +36 V
$V_{REF}$	-0.5 V to +6 V
$R_S$	-0.5 V to +6 V
Operating Temperature Range	-40°C to +85°C
Storage Temperature Range	-55°C to +150°C
ESD (Human Body Model)	3 kV
Lead Temperature	
Soldering (10 sec)	300°C
Vapor Phase (60 sec)	215°C
Infrared (15 sec)	220°C
$\theta_{JA}$ Thermal Impedance	53°C/W
$T_J$ Junction Temperature	130°C

Stresses above those listed under Absolute Maximum Ratings may cause permanent damage to the device. This is a stress rating only; functional operation of the device at these or any other conditions above those indicated in the operational section of this specification is not implied. Exposure to absolute maximum rating conditions for extended periods may affect device reliability.

**Table 7. Maximum Continuous Working Voltage<sup>1</sup>**

Parameter	Max	Unit	Reference Standard
AC Voltage			
Bipolar Waveform	424	V peak	50 year minimum lifetime
Unipolar Waveform			
Basic Insulation	560	V peak	Maximum approved working voltage per VDE 0884 Part 2
DC Voltage			
Basic Insulation	560	V peak	Maximum approved working voltage per VDE 0884 Part 2

<sup>1</sup> Refers to continuous voltage magnitude imposed across the isolation barrier. See the Insulation Lifetime section for more details.

### ESD CAUTION



**ESD (electrostatic discharge) sensitive device.** Charged devices and circuit boards can discharge without detection. Although this product features patented or proprietary protection circuitry, damage may occur on devices subjected to high energy ESD. Therefore, proper ESD precautions should be taken to avoid performance degradation or loss of functionality.

## PIN CONFIGURATION AND FUNCTION DESCRIPTIONS

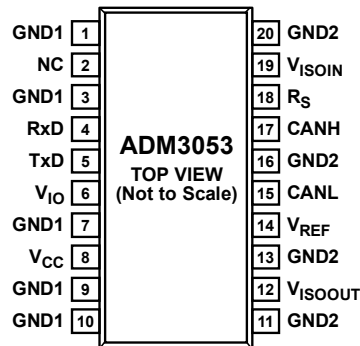

## NOTES

1. NC = NO CONNECT. DO NOT CONNECT TO THIS PIN.
2. PIN 12 AND PIN 19 MUST BE CONNECTED EXTERNALLY.

09293-005

Figure 4. Pin Configuration

Table 8. Pin Function Descriptions

Pin No.	Mnemonic	Description
1	GND1	Ground, Logic Side.
2	NC	No Connect. Do not connect to this pin.
3	GND1	Ground, Logic Side.
4	RxD	Receiver Output Data.
5	TxD	Driver Input Data.
6	V <sub>IO</sub>	<i>i</i> Coupler Power Supply. It is recommended that a 0.1 $\mu$ F and a 0.01 $\mu$ F decoupling capacitor be fitted between Pin 6 and GND1. See Figure 28 for layout recommendations.
7	GND1	Ground, Logic Side.
8	V <sub>CC</sub>	<i>iso</i> Power Power Supply. It is recommended that a 0.1 $\mu$ F and a 10 $\mu$ F decoupling capacitor be fitted between Pin 8 and Pin 9.
9	GND1	Ground, Logic Side.
10	GND1	Ground, Logic Side.
11	GND2	Ground, Bus Side.
12	V <sub>ISOOUT</sub>	Isolated Power Supply Output. This pin must be connected externally to V <sub>ISOIN</sub> . It is recommended that a reservoir capacitor of 10 $\mu$ F and a decoupling capacitor of 0.1 $\mu$ F be fitted between Pin 12 and Pin 11.
13	GND2	Ground (Bus Side).
14	V <sub>REF</sub>	Reference Voltage Output.
15	CANL	Low-Level CAN Voltage Input/Output.
16	GND2	Ground (Bus Side).
17	CANH	High-Level CAN Voltage Input/Output.
18	R <sub>S</sub>	Slope Resistor Input.
19	V <sub>ISOIN</sub>	Isolated Power Supply Input. This pin must be connected externally to V <sub>ISOOUT</sub> . It is recommended that a 0.1 $\mu$ F and a 0.01 $\mu$ F decoupling capacitor be fitted between Pin 19 and Pin 20.
20	GND2	Ground (Bus Side).



### TYPICAL PERFORMANCE CHARACTERISTICS

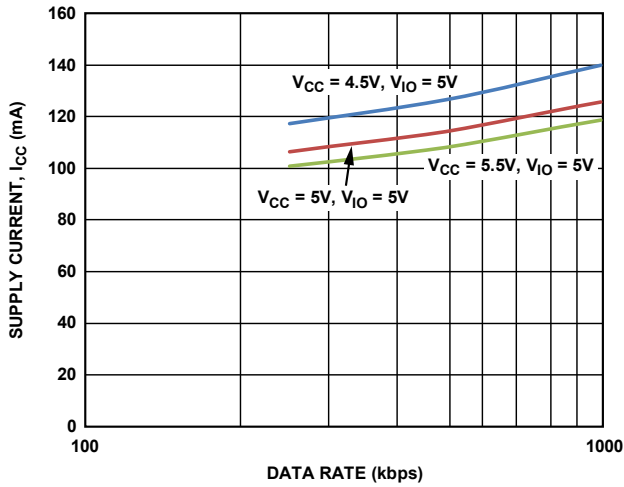

Figure 5. Supply Current,  $I_{CC}$  vs. Data Rate

09293-100

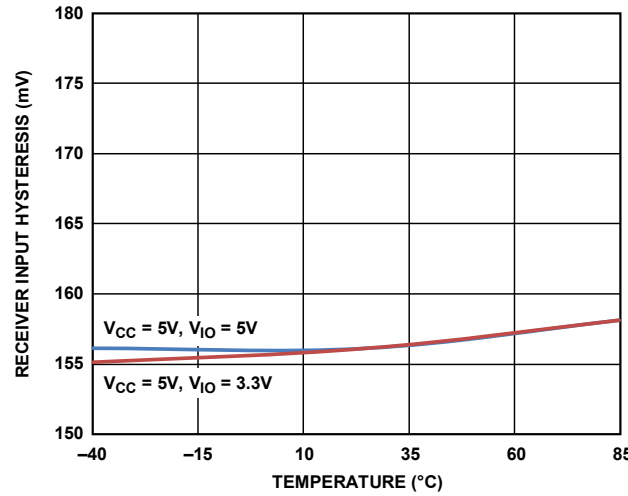

Figure 8. Receiver Input Hysteresis vs. Temperature

09293-103

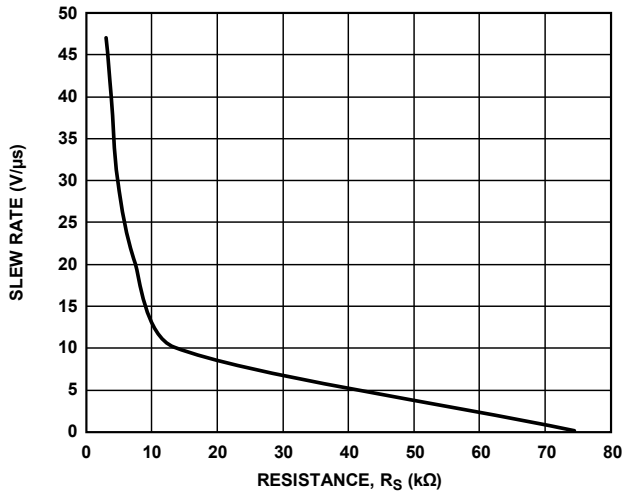

Figure 6. Driver Slew Rate vs. Resistance,  $R_S$

09293-101

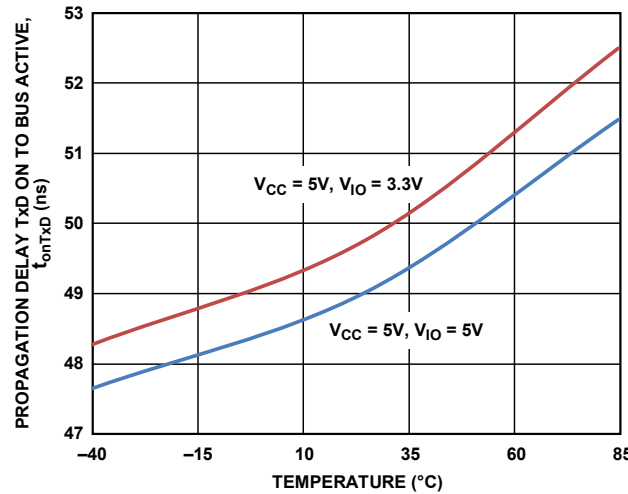

Figure 9. Propagation Delay from TxD On to Bus Active vs. Temperature

09293-104

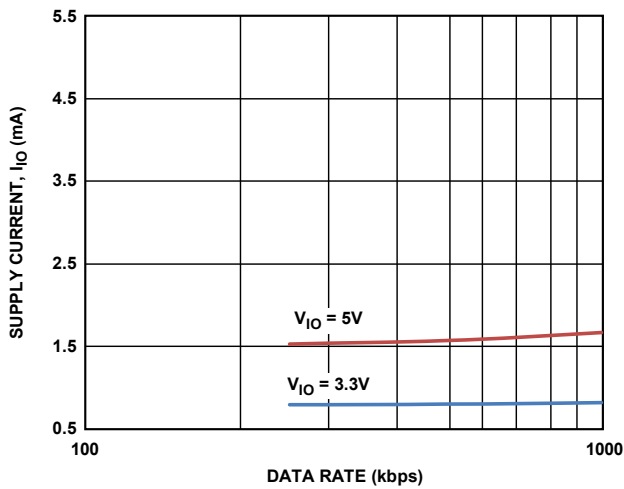

Figure 7. Supply Current,  $I_{IO}$  vs. Data Rate

09293-102

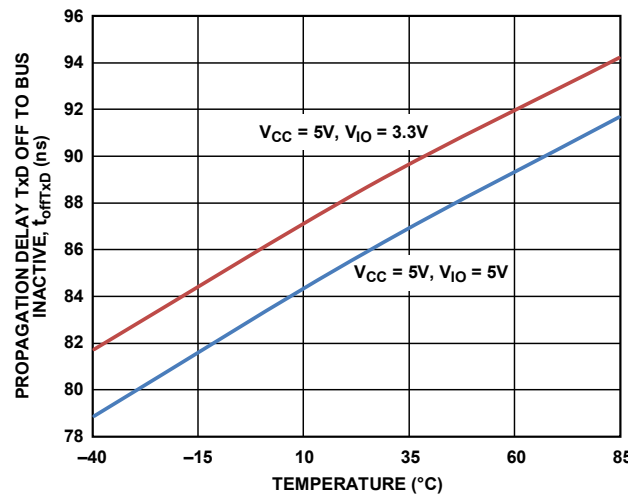

Figure 10. Propagation Delay from TxD Off to Bus Inactive vs. Temperature

09293-105

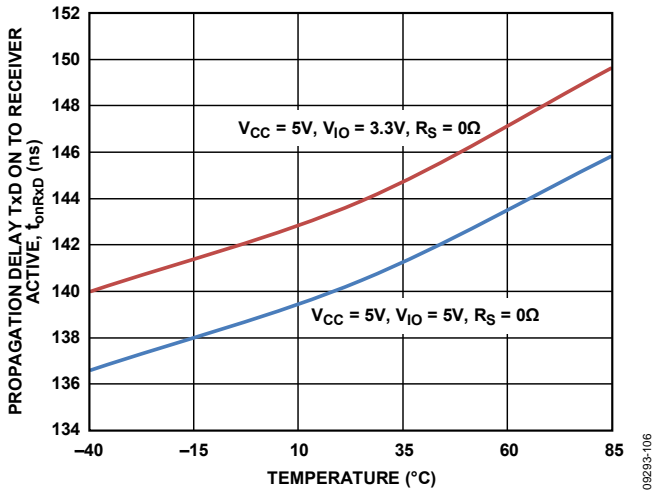

Figure 11. Propagation Delay from TxD Off to Bus Inactive vs. Temperature

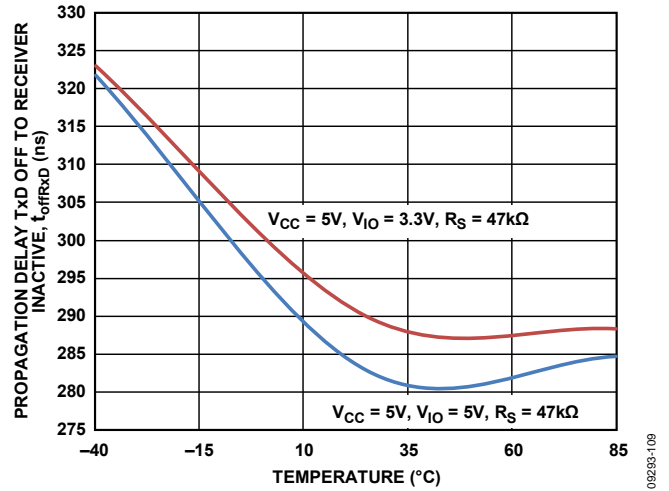

Figure 14. Propagation Delay from TxD Off to Receiver Inactive vs. Temperature

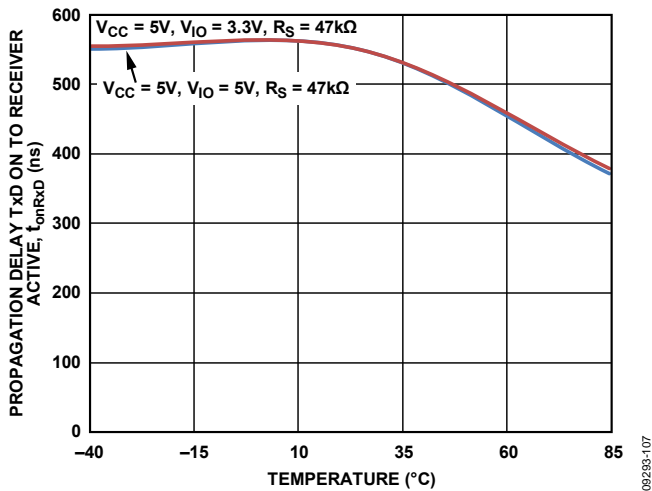

Figure 12. Propagation Delay from TxD On to Receiver Active vs. Temperature

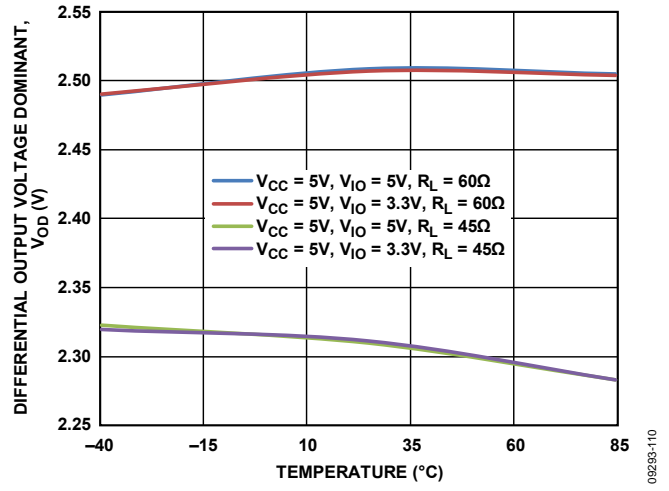

Figure 15. Differential Output Voltage Dominant vs. Temperature

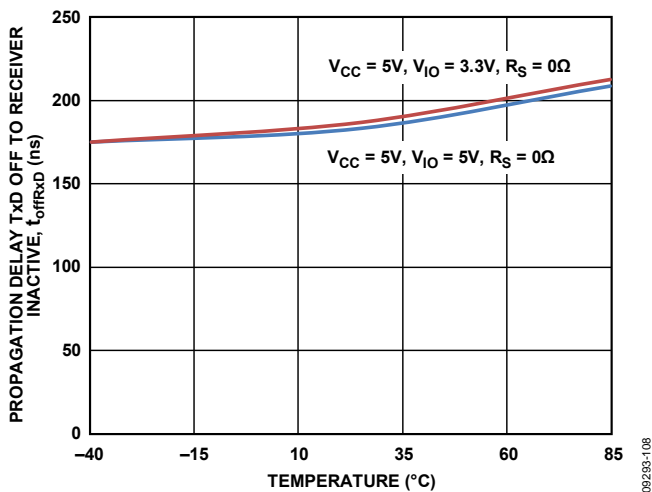

Figure 13. Propagation Delay from TxD Off to Receiver Inactive vs. Temperature

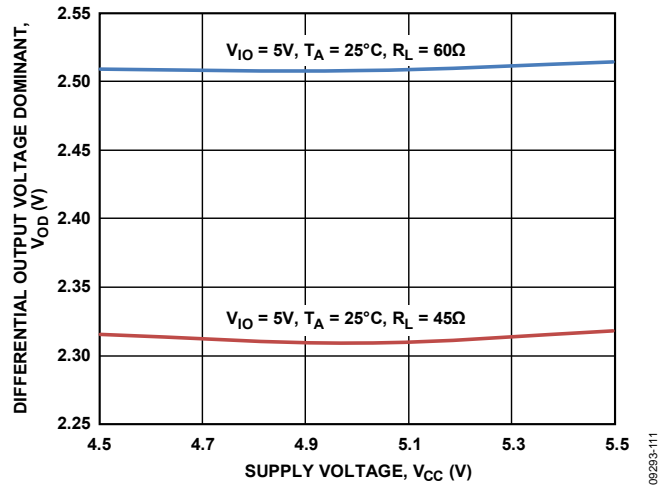

Figure 16. Differential Output Voltage Dominant vs. Supply Voltage, VCC

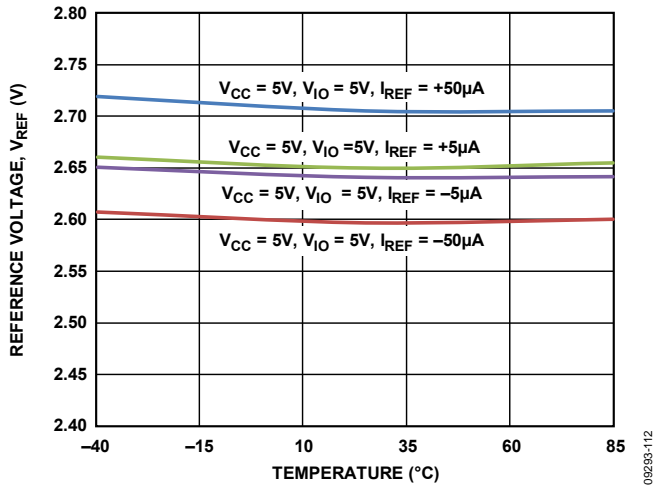

Figure 17. Reference Voltage vs. Temperature

09293-112

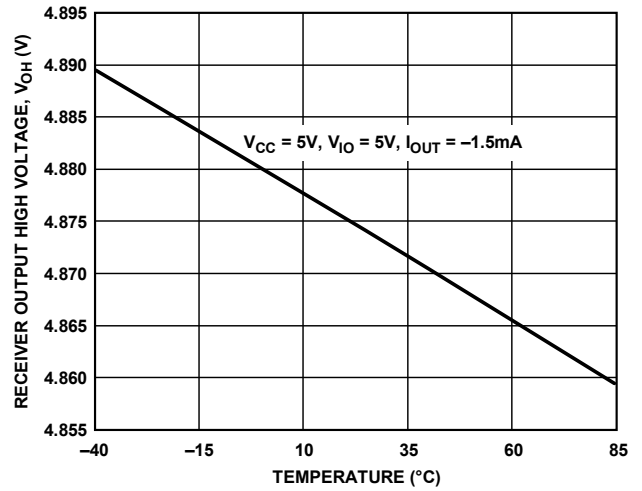

Figure 20. Receiver Output High Voltage vs. Temperature

09293-115

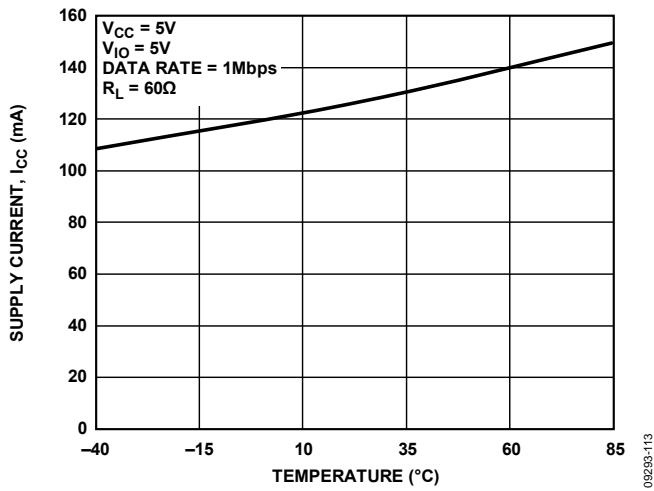

Figure 18. Supply Current  $I_{CC}$  vs. Temperature

09293-113

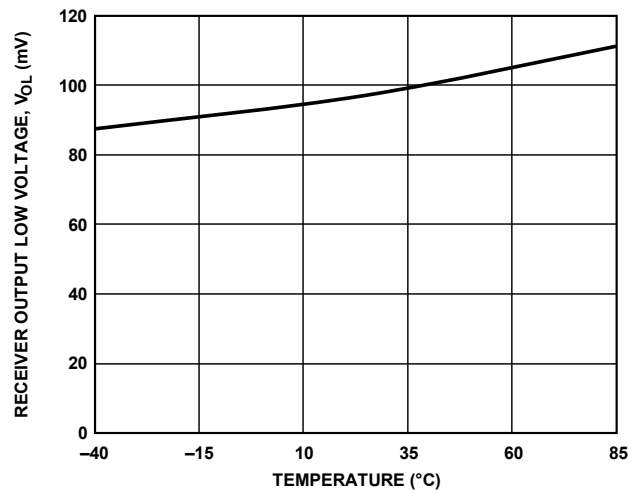

Figure 21. Receiver Output Low Voltage vs. Temperature

09293-116

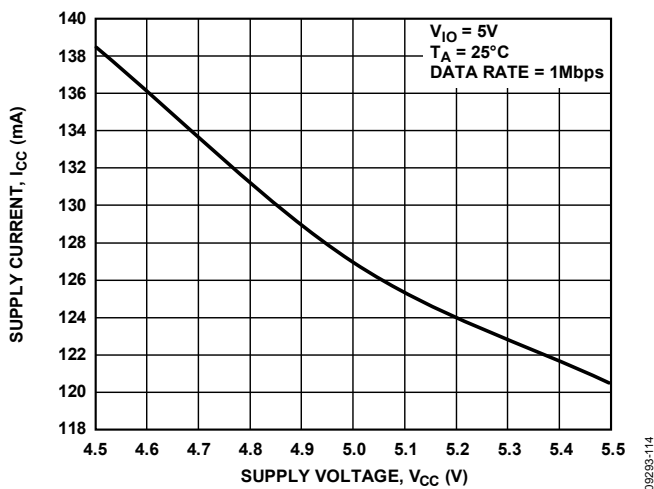

Figure 19. Supply Current,  $I_{CC}$  vs. Supply Voltage  $V_{CC}$

09293-114

TEST CIRCUITS

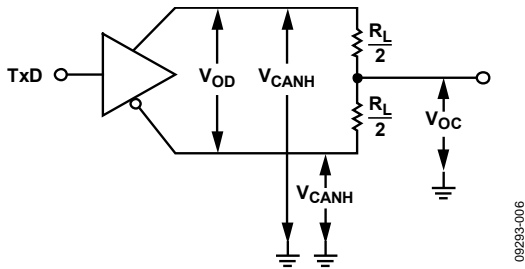

Figure 22. Driver Voltage Measurement

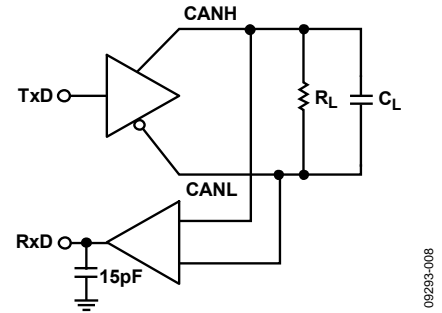

Figure 24. Switching Characteristics Measurements

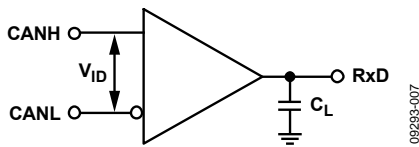

Figure 23. Receiver Voltage Measurements

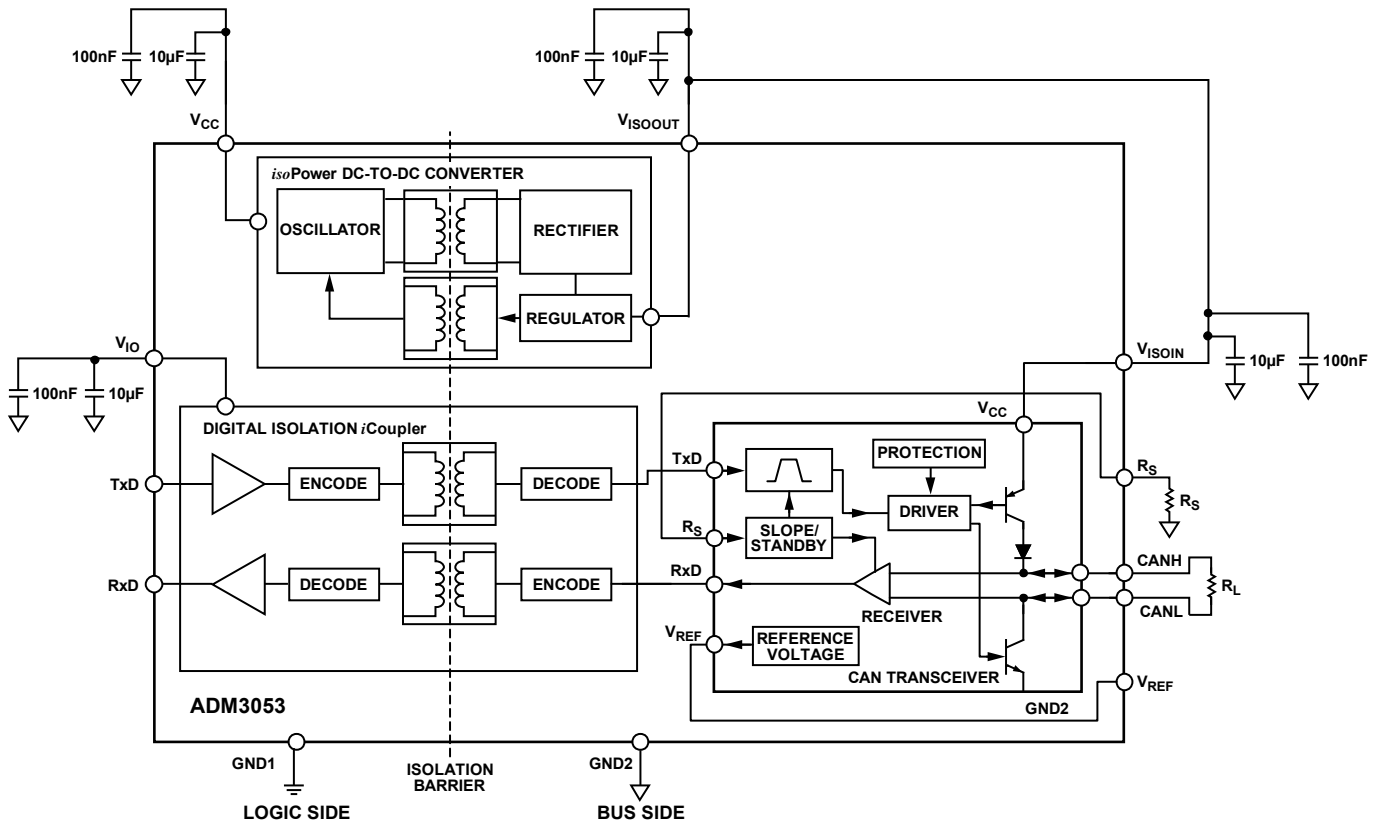

Figure 25. Supply Current Measurement Test Circuit

## CIRCUIT DESCRIPTION

### CAN TRANSCEIVER OPERATION

A CAN bus has two states called dominant and recessive. A dominant state is present on the bus when the differential voltage between CANH and CANL is greater than 0.9 V. A recessive state is present on the bus when the differential voltage between CANH and CANL is less than 0.5 V. During a dominant bus state, the CANH pin is high, and the CANL pin is low. During a recessive bus state, both the CANH and CANL pins are in the high impedance state.

Pin 18 (Rs) allows two different modes of operation to be selected: high-speed and slope control. For high-speed operation, the transmitter output transistors are simply switched on and off as fast as possible. In this mode, no measures are taken to limit the rise and fall slopes. A shielded cable is recommended to avoid EMI problems. High-speed mode is selected by connecting Pin 18 to ground.

Slope control mode allows the use of an unshielded twisted pair or a parallel pair of wires as bus lines. To reduce EMI, the rise and fall slopes should be limited. The rise and fall slopes can be programmed with a resistor connected from Pin 18 to ground. The slope is proportional to the current output at Pin 18.

### SIGNAL ISOLATION

The ADM3053 signal isolation is implemented on the logic side of the interface. The part achieves signal isolation by having a digital isolation section and a transceiver section (see Figure 1). Data applied to the TxD pin referenced to logic ground (GND1) are coupled across an isolation barrier to appear at the transceiver section referenced to isolated ground (GND2). Similarly, the single-ended receiver output signal, referenced to isolated ground in the transceiver section, is coupled across the isolation barrier to appear at the RxD pin referenced to logic ground (GND1). The signal isolation is powered by the V<sub>IO</sub> pin and allows the digital interface to 3.3 V or 5 V logic.

### POWER ISOLATION

The ADM3053 power isolation is implemented using an *isoPower* integrated isolated dc-to-dc converter. The dc-to-dc converter section of the ADM3053 works on principles that are common to most modern power supplies. It is a secondary side controller architecture with isolated pulse-width modulation (PWM) feedback. V<sub>CC</sub> power is supplied to an oscillating circuit that switches current into a chip-scale air core transformer. Power transferred to the secondary side is rectified and regulated to 5 V. The secondary (V<sub>ISO</sub>) side controller regulates the output by creating a PWM control signal that is sent to the primary (V<sub>CC</sub>) side by a dedicated *iCoupler* data channel. The PWM modulates the oscillator circuit to control the power being sent to the secondary side. Feedback allows for significantly higher power and efficiency.

### TRUTH TABLES

The truth tables in this section use the abbreviations found in Table 9.

Table 9. Truth Table Abbreviations

Letter	Description
H	High level
L	Low level
X	Don't care
Z	High impedance (off)
I	Indeterminate
NC	Not connected

Table 10. Transmitting

Supply Status		Input	Outputs		
V <sub>IO</sub>	V <sub>CC</sub>	TxD	Bus State	CANH	CANL
On	On	L	Dominant	H	L
On	On	H	Recessive	Z	Z
On	On	Floating	Recessive	Z	Z
Off	On	X	Recessive	Z	Z
On	Off	L	Indeterminate	I	I

Table 11. Receiving

Supply Status		Inputs		Output
V <sub>IO</sub>	V <sub>CC</sub>	V <sub>ID</sub> = CANH – CANL	Bus State	RxD
On	On	≥ 0.9 V	Dominant	L
On	On	≤ 0.5 V	Recessive	H
On	On	0.5 V < V <sub>ID</sub> < 0.9 V	X <sup>1</sup>	I
On	On	Inputs open	Recessive	H
Off	On	X <sup>1</sup>	X <sup>1</sup>	I
On	Off	X <sup>1</sup>	X <sup>1</sup>	H

<sup>1</sup>X = don't care.

### THERMAL SHUTDOWN

The ADM3053 contains thermal shutdown circuitry that protects the part from excessive power dissipation during fault conditions. Shorting the driver outputs to a low impedance source can result in high driver currents. The thermal sensing circuitry detects the increase in die temperature under this condition and disables the driver outputs. This circuitry is designed to disable the driver outputs when a die temperature of 150°C is reached. As the device cools, the drivers are reenabled at a temperature of 140°C.

### DC CORRECTNESS AND MAGNETIC FIELD IMMUNITY

The digital signals transmit across the isolation barrier using *iCoupler* technology. This technique uses chip-scale transformer windings to couple the digital signals magnetically from one side of the barrier to the other. Digital inputs are encoded into waveforms that are capable of exciting the primary transformer

winding. At the secondary winding, the induced waveforms are decoded into the binary value that was originally transmitted.

Positive and negative logic transitions at the isolator input cause narrow (~1 ns) pulses to be sent to the decoder via the transformer. The decoder is bistable and is, therefore, either set or reset by the pulses, indicating input logic transitions. In the absence of logic transitions at the input for more than 1 μs, periodic sets of refresh pulses indicative of the correct input state are sent to ensure dc correctness at the output. If the decoder receives no internal pulses of more than approximately 5 μs, the input side is assumed to be unpowered or nonfunctional, in which case, the isolator output is forced to a default state by the watchdog timer circuit.

This situation should occur in the ADM3053 devices only during power-up and power-down operations. The limitation on the ADM3053 magnetic field immunity is set by the condition in which induced voltage in the transformer receiving coil is sufficiently large to either falsely set or reset the decoder. The following analysis defines the conditions under which this can occur.

The 3.3 V operating condition of the ADM3053 is examined because it represents the most susceptible mode of operation. The pulses at the transformer output have an amplitude of >1.0 V. The decoder has a sensing threshold of about 0.5 V, thus establishing a 0.5 V margin in which induced voltages can be tolerated. The voltage induced across the receiving coil is given by

$$V = (-d\beta/dt)\Sigma\pi r_n^2; n = 1, 2, \dots, N$$

where:

$\beta$  is magnetic flux density (gauss).

$N$  is the number of turns in the receiving coil.

$r_n$  is the radius of the  $n^{\text{th}}$  turn in the receiving coil (cm).

Given the geometry of the receiving coil in the ADM3053 and an imposed requirement that the induced voltage be, at most, 50% of the 0.5 V margin at the decoder, a maximum allowable magnetic field is calculated as shown in Figure 26.

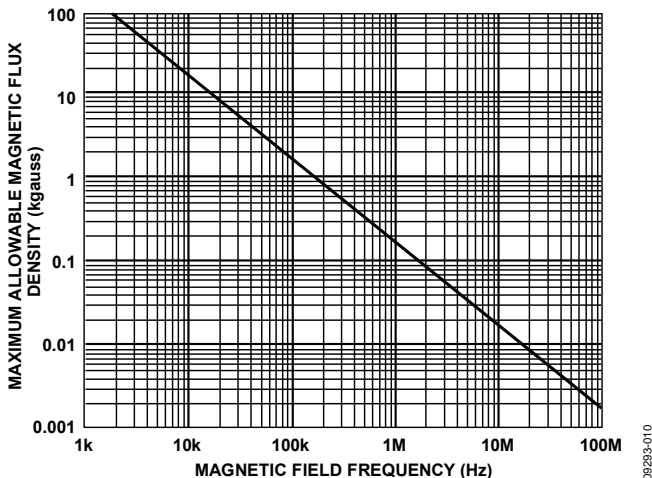

Figure 26. Maximum Allowable External Magnetic Flux Density

For example, at a magnetic field frequency of 1 MHz, the maximum allowable magnetic field of 0.2 kgauss induces a voltage of 0.25 V at the receiving coil. This is about 50% of the sensing threshold and does not cause a faulty output transition. Similarly, if such an event occurs during a transmitted pulse (and is of the worst-case polarity), it reduces the received pulse from >1.0 V to 0.75 V, which is still well above the 0.5 V sensing threshold of the decoder.

The preceding magnetic flux density values correspond to specific current magnitudes at given distances from the ADM3053 transformers. Figure 27 expresses these allowable current magnitudes as a function of frequency for selected distances. As shown in Figure 27, the ADM3053 is extremely immune and can be affected only by extremely large currents operated at high frequency very close to the component. For the 1 MHz example, a 0.5 kA current must be placed 5 mm away from the ADM3053 to affect component operation.

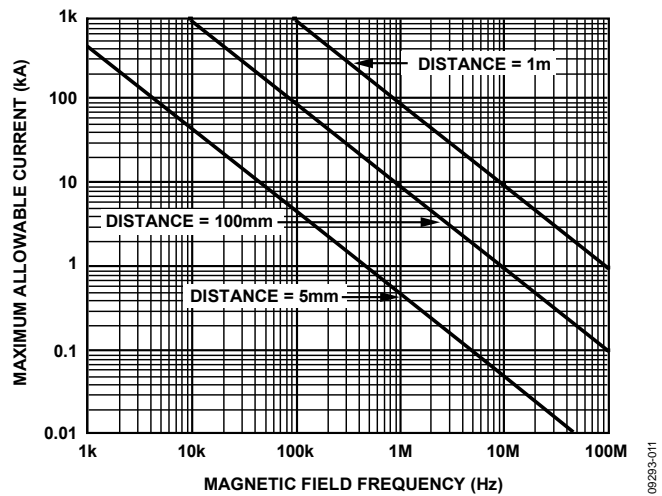

Figure 27. Maximum Allowable Current for Various Current-to-ADM3053 Spacings

Note that in combinations of strong magnetic field and high frequency, any loops formed by the printed circuit board (PCB) traces can induce error voltages sufficiently large to trigger the thresholds of succeeding circuitry. Proceed with caution in the layout of such traces to prevent this from occurring.

## APPLICATIONS INFORMATION

### PCB LAYOUT

The ADM3053 signal and power isolated CAN transceiver contains an *isoPower* integrated dc-to-dc converter, requiring no external interface circuitry for the logic interfaces. Power supply bypassing is required at the input and output supply pins (see Figure 28). The power supply section of the ADM3053 uses a 180 MHz oscillator frequency to pass power efficiently through its chip-scale transformers. In addition, the normal operation of the data section of the *iCoupler* introduces switching transients on the power supply pins.

Bypass capacitors are required for several operating frequencies. Noise suppression requires a low inductance, high frequency capacitor, whereas ripple suppression and proper regulation require a large value capacitor. These capacitors are connected between GND1 and Pin 6 ( $V_{IO}$ ) for  $V_{IO}$ . It is recommended that a combination of 100 nF and 10 nF be placed as shown in Figure 28 (C6 and C4). It is recommended that a combination of two capacitors, with values of 100 nF and 10  $\mu$ F, are placed between Pin 8 ( $V_{CC}$ ) and Pin 9 (GND1) for  $V_{CC}$  as shown in Figure 28 (C2 and C1). The  $V_{ISOIN}$  and  $V_{ISOOUT}$  capacitors are connected between Pin 11 (GND2) and Pin 12 ( $V_{ISOOUT}$ ) with recommended values of 100 nF and 10  $\mu$ F as shown in Figure 28 (C5 and C8). Two capacitors are recommended to be fitted Pin 19 ( $V_{ISOIN}$ ) and Pin 20 (GND2) with values of 100nF and 10nF as shown in Figure 28 (C9 and C7). The best practice recommended is to use a very low inductance ceramic capacitor, or its equivalent, for the smaller value. The total lead length between both ends of the capacitor and the input power supply pin should not exceed 10 mm.

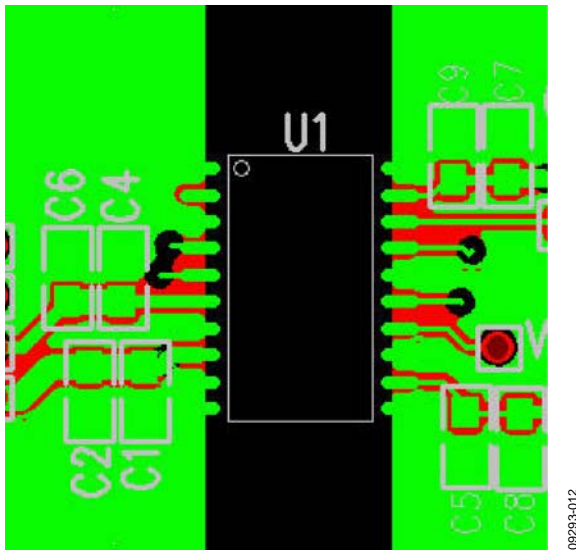

Figure 28. Recommended PCB Layout

In applications involving high common-mode transients, ensure that board coupling across the isolation barrier is minimized. Furthermore, design the board layout such that any coupling that does occur equally affects all pins on a given component side. Failure to ensure this can cause voltage differentials between

pins exceeding the absolute maximum ratings for the device, thereby leading to latch-up and/or permanent damage.

The ADM3053 dissipates approximately 650 mW of power when fully loaded. Because it is not possible to apply a heat sink to an isolation device, the devices primarily depend on heat dissipation into the PCB through the GND pins. If the devices are used at high ambient temperatures, provide a thermal path from the GND pins to the PCB ground plane. The board layout in Figure 28 shows enlarged pads for Pin 1, Pin 3, Pin 9, Pin 10, Pin 11, Pin 14, Pin 16, and Pin 20. Implement multiple vias from the pad to the ground plane to reduce the temperature inside the chip significantly. The dimensions of the expanded pads are at the discretion of the designer and dependent on the available board space.

### EMI CONSIDERATIONS

The dc-to-dc converter section of the ADM3053 must, of necessity, operate at very high frequency to allow efficient power transfer through the small transformers. This creates high frequency currents that can propagate in circuit board ground and power planes, causing edge and dipole radiation. Grounded enclosures are recommended for applications that use these devices. If grounded enclosures are not possible, good RF design practices should be followed in the layout of the PCB. See the [AN-0971](#) Application Note, *Control of Radiated Emissions with isoPower Devices*, for more information.

### INSULATION LIFETIME

All insulation structures eventually break down when subjected to voltage stress over a sufficiently long period. The rate of insulation degradation is dependent on the characteristics of the voltage waveform applied across the insulation. Analog Devices conducts an extensive set of evaluations to determine the lifetime of the insulation structure within the ADM3053.

Accelerated life testing is performed using voltage levels higher than the rated continuous working voltage. Acceleration factors for several operating conditions are determined, allowing calculation of the time to failure at the working voltage of interest. The values shown in Table 5 summarize the peak voltages for 50 years of service life in several operating conditions. In many cases, the working voltage approved by agency testing is higher than the 50 year service life voltage. Operation at working voltages higher than the service life voltage listed leads to premature insulation failure.

The insulation lifetime of the ADM3053 depends on the voltage waveform type imposed across the isolation barrier. The *iCoupler* insulation structure degrades at different rates, depending on whether the waveform is bipolar ac, unipolar ac, or dc. Figure 29, Figure 30, and Figure 31 illustrate these different isolation voltage waveforms.

Bipolar ac voltage is the most stringent environment. A 50 year operating lifetime under the bipolar ac condition determines the Analog Devices recommended maximum working voltage.

In the case of unipolar ac or dc voltage, the stress on the insulation is significantly lower. This allows operation at higher working voltages while still achieving a 50 year service life. The working voltages listed in Table 5 can be applied while maintaining the 50 year minimum lifetime, provided the voltage conforms to either the unipolar ac or dc voltage cases. Any cross insulation voltage waveform that does not conform to Figure 30 or Figure 31 should be treated as a bipolar ac waveform, and its peak voltage should be limited to the 50-year lifetime voltage value listed in Table 5.

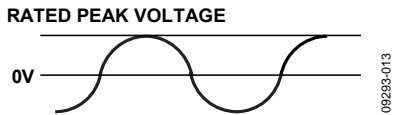

Figure 29. Bipolar AC Waveform

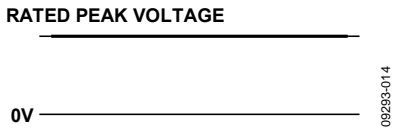
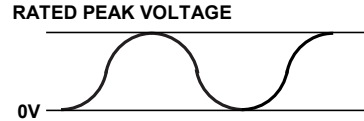

Figure 30. DC Waveform



**NOTES**  
 1. THE VOLTAGE IS SHOWN AS SINUSODIAL FOR ILLUSTRATION PURPOSES ONLY. IT IS MEANT TO REPRESENT ANY VOLTAGE WAVEFORM VARYING BETWEEN 0 AND SOME LIMITING VALUE. THE LIMITING VALUE CAN BE POSITIVE OR NEGATIVE, BUT THE VOLTAGE CANNOT CROSS 0V.

Figure 31. Unipolar AC Waveform

08293-015



# TYPICAL APPLICATIONS

Figure 32 is an example circuit diagram using the ADM3053.

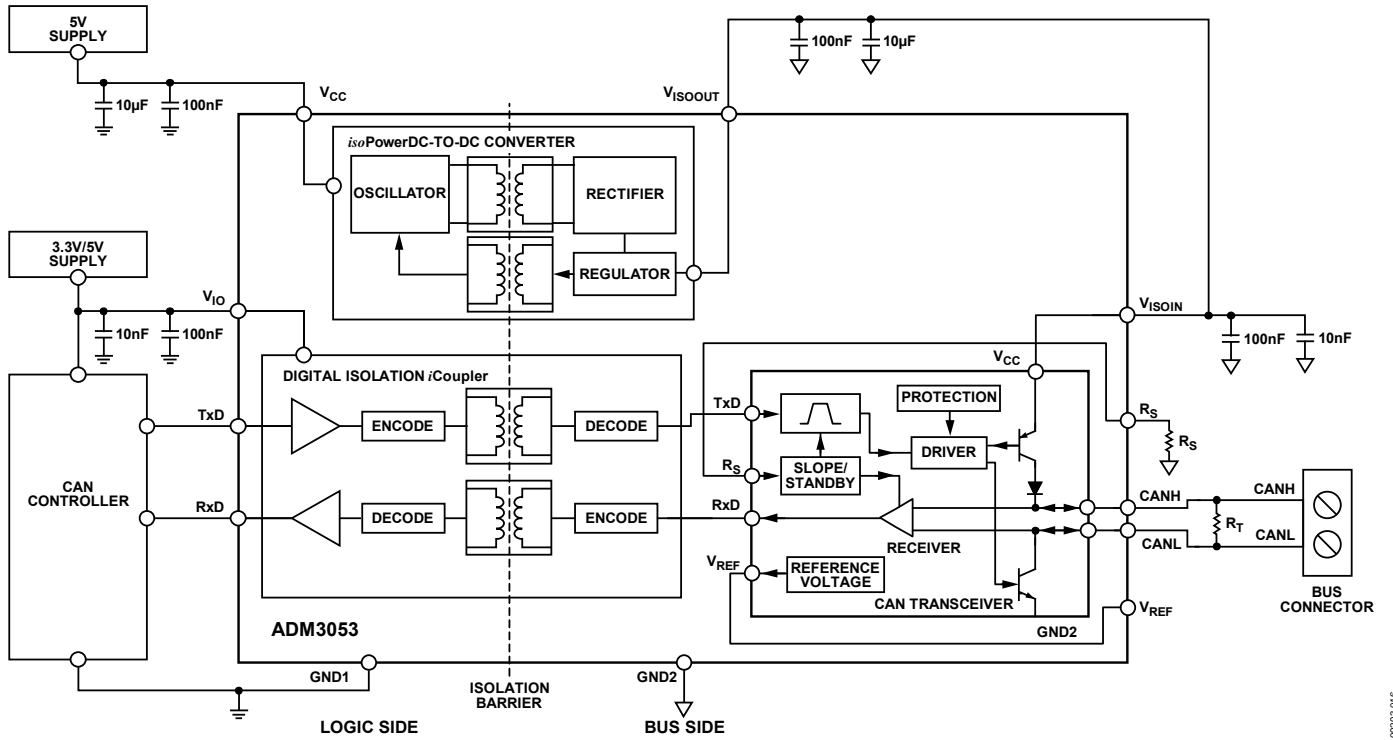
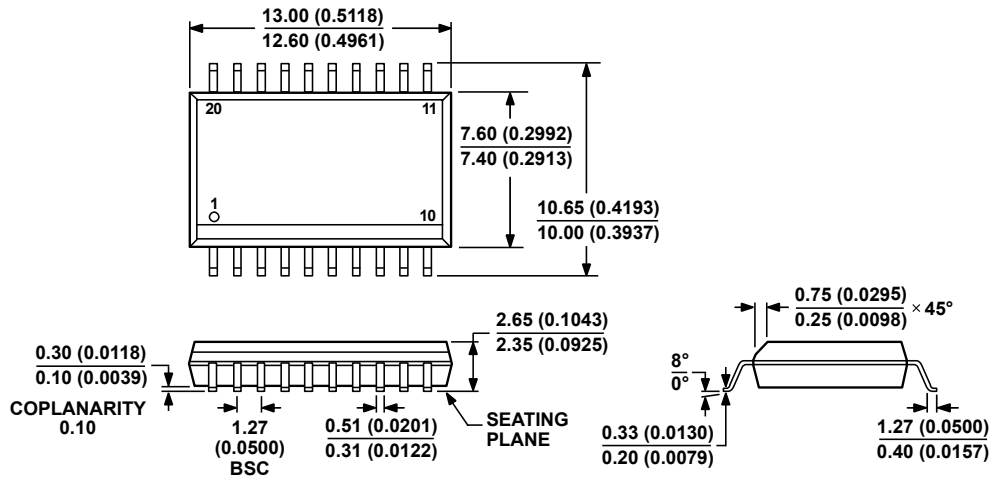

Figure 32. Example Circuit Diagram Using the ADM3053

00293-016

OUTLINE DIMENSIONS



COMPLIANT TO JEDEC STANDARDS MS-013-AC  
 CONTROLLING DIMENSIONS ARE IN MILLIMETERS; INCH DIMENSIONS  
 (IN PARENTHESES) ARE ROUNDED-OFF MILLIMETER EQUIVALENTS FOR  
 REFERENCE ONLY AND ARE NOT APPROPRIATE FOR USE IN DESIGN.

Figure 33. 20-Lead Standard Small Outline Package [SOIC\_W]  
 Wide Body  
 (RW-20)  
 Dimensions shown in millimeters and (inches)

06-07-2006-A

ORDERING GUIDE

Model <sup>1</sup>	Temperature Range	Package Description	Package Option
ADM3053BRWZ	-40°C to +85°C	20-Lead SOIC_W	RW-20
ADM3053BRWZ-REEL7	-40°C to +85°C	20-Lead SOIC_W	RW-20
EVAL-ADM3053EBZ		ADM3053 Evaluation Board	

<sup>1</sup> Z = RoHS Compliant Part.

**NOTES**

**NOTES**