

UJA1066

High-speed CAN fail-safe system basis chip

Rev. 03 — 17 March 2010

Product data sheet

1. General description

The UJA1066 fail-safe System Basis Chip (SBC) replaces basic discrete components which are common in every Electronic Control Unit (ECU) with a Controller Area Network (CAN) interface. The fail-safe SBC supports all networking applications that control various power and sensor peripherals by using high-speed CAN as the main network interface. The fail-safe SBC contains the following integrated devices:

- High-speed CAN transceiver, interoperable and downward compatible with CAN transceiver TJA1041 and TJA1041A, and compatible with the ISO 11898-2 standard and the ISO 11898-5 standard (in preparation)
- Advanced independent watchdog
- Dedicated voltage regulators for microcontroller and CAN transceiver
- Serial peripheral interface (full duplex)
- Local wake-up input port
- Inhibit/limp-home output port

In addition to the advantages of integrating these common ECU functions in a single package, the fail-safe SBC offers an intelligent combination of system-specific functions such as:

- Advanced low-power concept
- Safe and controlled system start-up behavior
- Advanced fail-safe system behavior that prevents any conceivable deadlock
- Detailed status reporting on system and subsystem levels

The UJA1066 is designed to be used in combination with a microcontroller that incorporates a CAN controller. The fail-safe SBC ensures that the microcontroller is always started up in a defined manner. In failure situations, the fail-safe SBC will maintain microcontroller functionality for as long as possible to provide a full monitoring and software-driven fallback operation.

The UJA1066 is designed for 14 V single power supply architectures and for 14 V and 42 V dual power supply architectures.



2. Features and benefits

2.1 General

- Contains a full set of CAN ECU functions:
 - ◆ CAN transceiver
 - ◆ Voltage regulator for the microcontroller (3.3 V or 5.0 V)
 - ◆ Separate voltage regulator for the CAN transceiver (5 V)
 - ◆ Enhanced window watchdog with on-chip oscillator
 - ◆ Serial Peripheral Interface (SPI) for the microcontroller
 - ◆ ECU power management system
 - ◆ Fully integrated autonomous fail-safe system
- Designed for automotive applications:
 - ◆ Supports 14 V and 42 V architectures
 - ◆ Excellent ElectroMagnetic Compatibility (EMC) performance
 - ◆ ±8 kV ElectroStatic Discharge (ESD) protection Human Body Model (HBM) for off-board pins
 - ◆ ±4 kV ElectroStatic Discharge (ESD) protection IEC 61000-4-2 for off-board pins
 - ◆ ±60 V short-circuit proof CAN-bus pins
 - ◆ Battery and CAN-bus pins are protected against transients in accordance with ISO 7637-3
 - ◆ Very low sleep current
- Supports remote flash programming via the CAN-bus
- Small 8 mm × 11 mm HTSSOP32 package with low thermal resistance

2.2 CAN transceiver

- ISO 11898-2 and ISO 11898-5 compliant high-speed CAN transceiver
- Enhanced error signalling and reporting
- Dedicated low dropout voltage regulator for the CAN-bus:
 - ◆ Independent of the microcontroller supply
 - ◆ Guarded by CAN-bus failure management
 - ◆ Significantly improves EMC performance
- Partial networking option with global wake-up feature; allows selective CAN-bus communication without waking up sleeping nodes
- Bus connections are truly floating when power is off
- SPLIT output pin for stabilizing the recessive bus level

2.3 Power management

- Smart operating modes and power management modes
- Cyclic wake-up capability in Standby and Sleep modes
- Local wake-up input with cyclic supply feature
- Remote wake-up capability via the CAN-bus
- External voltage regulators can easily be incorporated into the power supply system (flexible and fail-safe)
- 42 V battery-related high-side switch for driving external loads such as relays and wake-up switches
- Intelligent maskable interrupt output

2.4 Fail-safe features

- Safe and predictable behavior under all conditions
- Programmable fail-safe coded window and time-out watchdog with on-chip oscillator, guaranteeing autonomous fail-safe system supervision
- Fail-safe coded 16-bit SPI interface for the microcontroller
- Global enable pin for the control of safety-critical hardware
- Detection and detailed reporting of failures:
 - ◆ On-chip oscillator failure and watchdog alerts
 - ◆ Battery and voltage regulator undervoltages
 - ◆ CAN-bus failures (short circuits and open-circuit bus wires)
 - ◆ TXD and RXD clamping situations and short circuits
 - ◆ Clamped or open reset line
 - ◆ SPI message errors
 - ◆ Overtemperature warning
 - ◆ ECU ground shift (two selectable thresholds)
- Rigorous error handling based on diagnostics
- Supply failure early warning allows critical data to be stored
- 23 bits of access-protected RAM available (e.g. for logging cyclic problems)
- Reporting in a single SPI message; no assembly of multiple SPI frames needed
- Limp-home output signal for activating application hardware in case system enters Fail-safe mode (e.g. for switching on warning lights)
- Fail-safe coded activation of Software development mode and Flash mode
- Unique SPI readable device type identification
- Software-initiated system reset

3. Ordering information

Table 1. Ordering information

| Type number ^[1] | Package | | Version |
|----------------------------|----------|--|----------|
| | Name | Description | |
| UJA1066TW | HTSSOP32 | plastic thermal enhanced thin shrink small outline package; 32 leads; body width 6.1 mm; lead pitch 0.65 mm; exposed die pad | SOT549-1 |

[1] UJA1066TW/5V0 is for the 5 V version; UJA1066TW/3V3 is for the 3.3 V version.

4. Block diagram

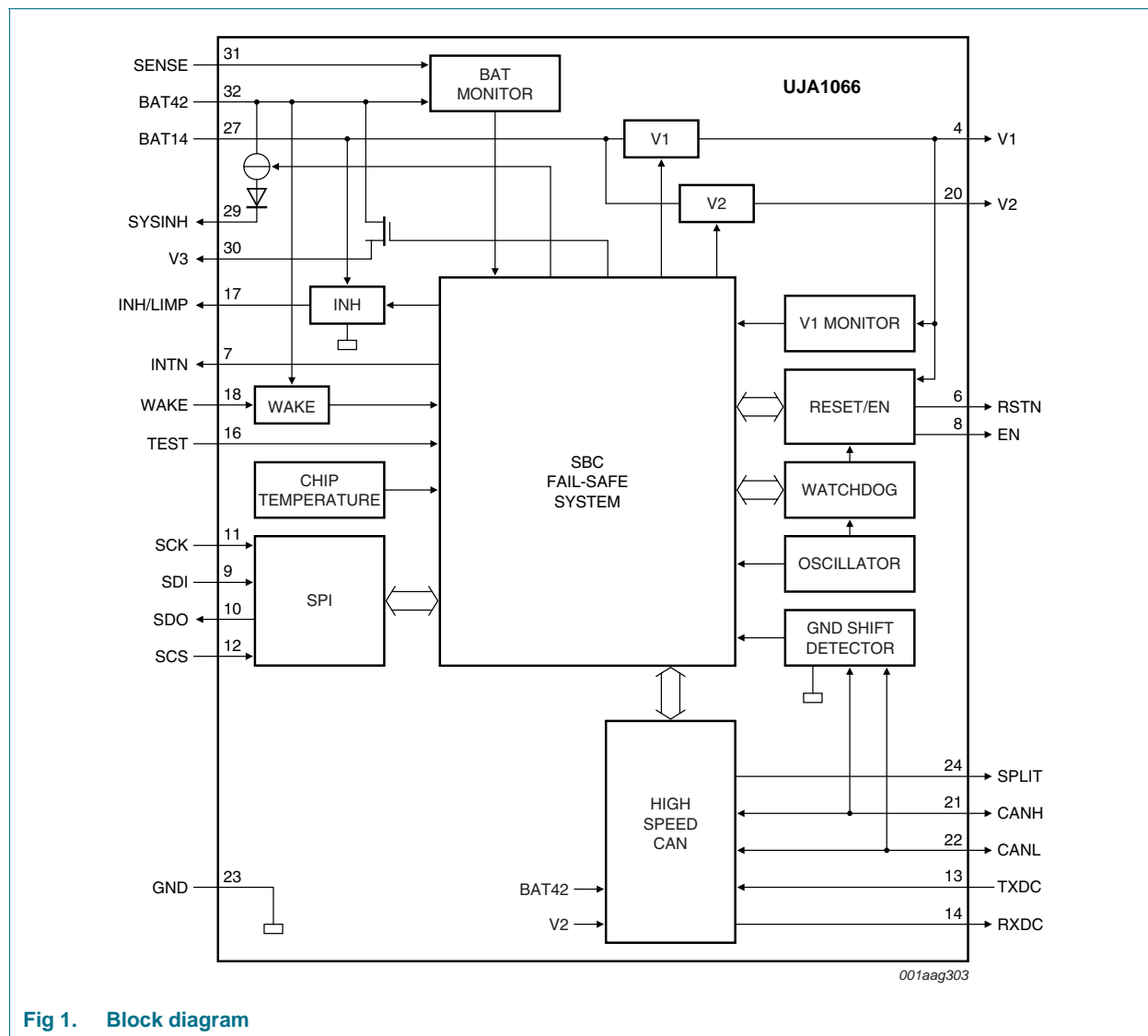
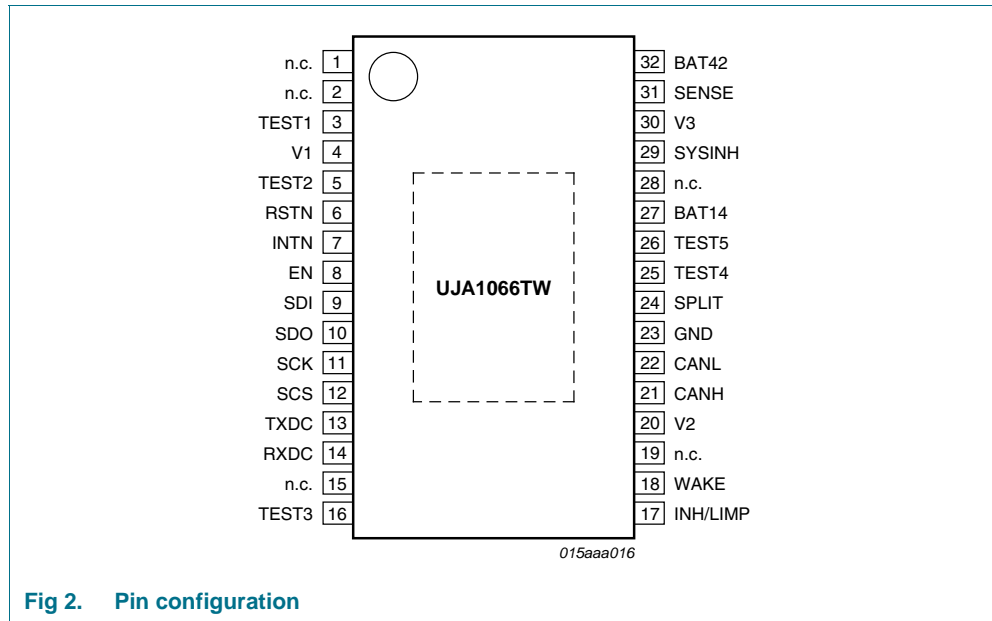

Fig 1. Block diagram

5. Pinning information

5.1 Pinning



5.2 Pin description

Table 2. Pin description

| Symbol | Pin | Description |
|--------|-----|--|
| n.c. | 1 | not connected |
| n.c. | 2 | not connected |
| i.c. | 3 | internally connected; must be left open in the application |
| V1 | 4 | voltage regulator output for the microcontroller (3.3 V or 5 V depending on the SBC version) |
| i.c. | 5 | internally connected; must be left open in the application |
| RSTN | 6 | reset output to microcontroller (active LOW; will detect clamping situations) |
| INTN | 7 | interrupt output to microcontroller (active LOW; open-drain; wire-AND this pin to other ECU interrupt outputs) |
| EN | 8 | enable output (active HIGH; push-pull; LOW with every reset/watchdog overflow) |
| SDI | 9 | SPI data input |
| SDO | 10 | SPI data output (floating when pin SCS is HIGH) |
| SCK | 11 | SPI clock input |
| SCS | 12 | SPI chip select input (active LOW) |
| TXDC | 13 | CAN transmit data input (LOW when dominant; HIGH when recessive) |
| RXDC | 14 | CAN receive data output (LOW when dominant; HIGH when recessive) |
| n.c. | 15 | not connected |
| TEST | 16 | test pin (should be connected to ground in the application) |

Table 2. Pin description ...continued

| Symbol | Pin | Description |
|----------|-----|---|
| INH/LIMP | 17 | inhibit/limp-home output (BAT14 related, push-pull, default floating) |
| WAKE | 18 | local wake-up input (BAT42 related, continuous or cyclic sampling) |
| n.c. | 19 | not connected |
| V2 | 20 | 5 V voltage regulator output for CAN; connect a buffer capacitor to this pin |
| CANH | 21 | CANH bus line (HIGH in dominant state) |
| CANL | 22 | CANL bus line (LOW in dominant state) |
| GND | 23 | ground |
| SPLIT | 24 | CAN-bus common mode stabilization output |
| i.c. | 25 | internally connected; must be connected to pin BAT42 in the application |
| i.c. | 26 | internally connected; must be left open in the application |
| BAT14 | 27 | 14 V battery supply input |
| n.c. | 28 | not connected |
| SYINH | 29 | system inhibit output; BAT42 related (e.g. for controlling external DC-to-DC converter) |
| V3 | 30 | unregulated 42 V output (BAT42 related; continuous output or Cyclic mode synchronized with local wake-up input) |
| SENSE | 31 | fast battery interrupt / chatter detector input |
| BAT42 | 32 | 42 V battery supply input (connect this pin to BAT14 in 14 V applications) |

The exposed die pad at the bottom of the package allows better dissipation of heat from the SBC via the printed-circuit board. The exposed die pad is not connected to any active part of the IC and can be left floating, or can be connected to GND for the best EMC performance.

6. Functional description

6.1 Introduction

The UJA1066 combines all the peripheral functions found around a microcontroller in a typical automotive networking application in a single, dedicated chip. These functions are:

- Power supply for the microcontroller
- Power supply for the CAN transceiver
- Switched BAT42 output
- System reset
- Watchdog with Window and Time-out modes
- On-chip oscillator
- High-speed CAN transceiver for serial communication; suitable for 14 V and 42 V applications
- SPI control interface
- Local wake-up input
- Inhibit or limp-home output
- System inhibit output port
- Compatible with 42 V power supply systems
- Fail-safe behavior

6.2 Fail-safe system controller

The fail-safe system controller is at the core of the UJA1066 and is supervised by a watchdog timer that is clocked directly by the dedicated on-chip oscillator. The system controller manages the register configuration and controls the internal functions of the SBC. Detailed device status information is collected and presented to the microcontroller. The system controller also provides the reset and interrupt signals.

The fail-safe system controller is a state machine. The SBC operating modes, and how transitions between modes are triggered, are illustrated in [Figure 3](#). These modes are discussed in more detail in the following sections.

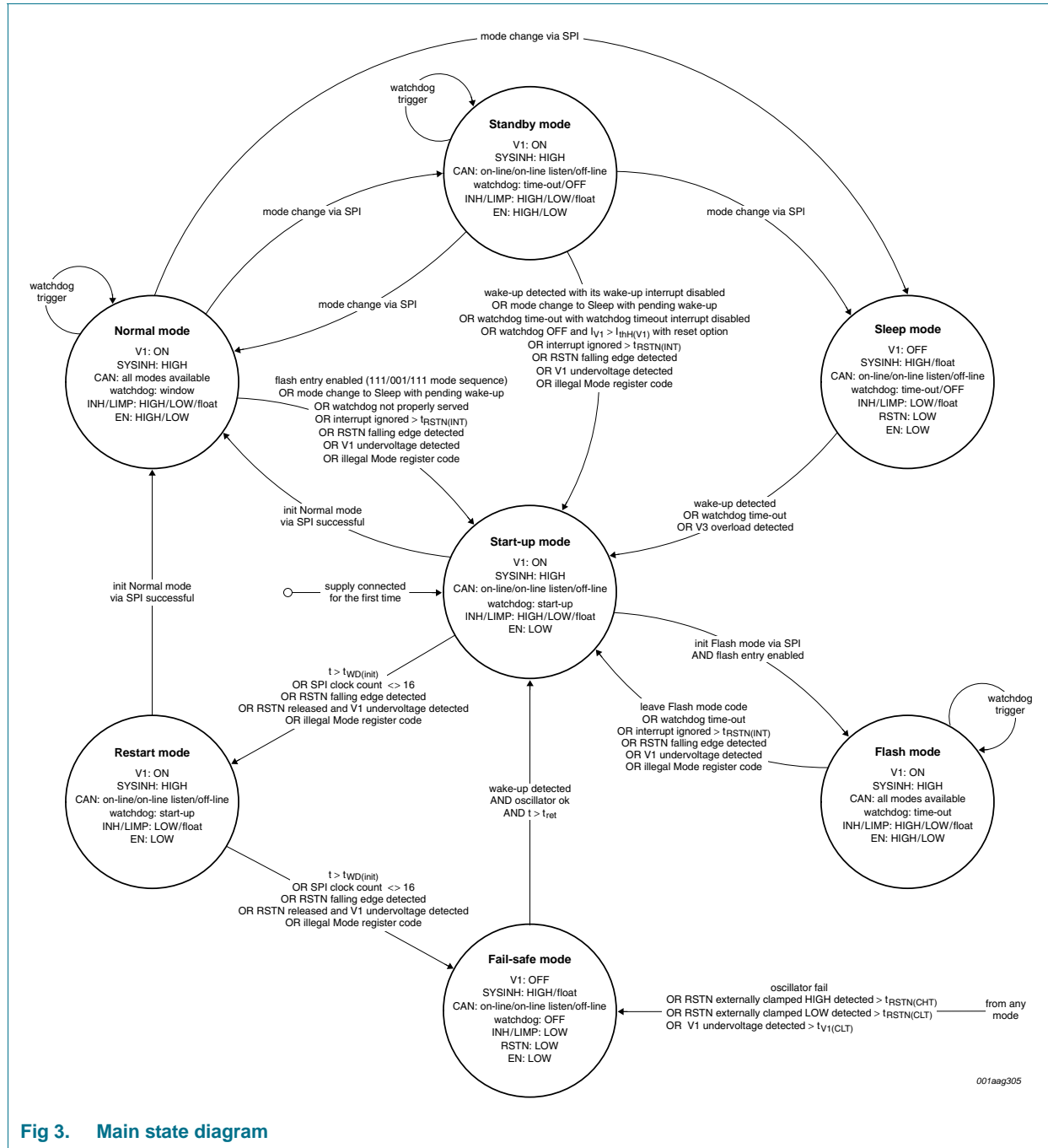

Fig 3. Main state diagram

6.2.1 Start-up mode

Start-up mode is the 'home page' of the SBC. This mode is entered when battery and ground are connected for the first time. Start-up mode is also entered after any event that results in a system reset. The reset source information is provided by the SBC to support software initialization cycles that depend on the reset event.

It is also possible to enter Start-up mode via a wake-up from Standby mode, Sleep mode or Fail-safe mode. Such a wake-up event can be triggered in the CAN-bus or by the local WAKE pin.

A lengthened reset time, t_{RSTNL} , is observed on entering Start-up mode. This reset time is either user-defined (via the RLC bit in the System Configuration register; see [Table 11](#) and [Table 27](#)) or defaults to the value given in [Section 6.12.12](#). Pin RSTN is held LOW by the SBC during the reset lengthening time.

When the reset time has elapsed (pin RSTN is released and goes HIGH) the watchdog timer will wait to be initialized. If the watchdog initialization is successful, the selected operating mode (Normal mode or Flash mode) will be entered. Otherwise the SBC will enter Restart mode.

6.2.2 Restart mode

The purpose of Restart mode is to give the application a second chance to start up, should the first attempt from Start-up mode fail. Entering Restart mode will always set the reset lengthening time t_{RSTNL} to the higher value (see [Table 27](#)) to guarantee the maximum reset length, regardless of previous events.

If start-up from Restart mode is successful (the earlier problems do not recur and watchdog initialization is successful), the SBC will enter Normal mode (see [Figure 3](#)). If problems persist or if V1 fails to start up, the SBC will enter Fail-safe mode.

6.2.3 Fail-safe mode

Severe fault situations will cause the SBC to enter Fail-safe mode. Fail-safe mode is also entered if start-up from Restart mode fails. Fail-safe mode offers the lowest possible system power consumption from the SBC and from the external components controlled by the SBC.

A wake-up (via the CAN-bus or the WAKE pin) is needed to leave Fail-safe mode. This is only possible if the on-chip oscillator is running correctly. The SBC restarts from Fail-safe mode with a defined delay, t_{ret} , to guarantee a discharged V1 before entering Start-up mode. Regulator V1 will restart and t_{RSTNL} will be set to the higher value (see [Section 6.5.1](#)).

6.2.4 Normal mode

Normal mode gives access to all SBC system resources, including CAN, INH/LIMP and EN. The SBC watchdog runs in (programmable) Window mode to guarantee the strictest software supervision. A system reset is performed whenever the watchdog is not being properly served.

Interrupts from the SBC to the host microcontroller are also monitored. A system reset is performed if the host microcontroller does not respond within $t_{RSTN(INT)}$.

Entering Normal mode does not activate the CAN transceiver automatically. The CAN Mode Control (CMC) bit must be set to activate the CAN medium if required, allowing local cyclic wake-up scenarios to be implemented without affecting the CAN-bus.

6.2.5 Standby mode

In Standby mode, the system is in a reduced current consumption state. Entering Standby mode overrides the CMC bit, allowing the CAN transceiver to enter the low-power mode autonomously. The watchdog will, however, continue to monitor the microcontroller (Time-out mode) since it is powered via pin V1.

If the host microcontroller supports a low-power Standby or Stop mode with reduced current consumption, the watchdog can be switched off entirely when the SBS is in Standby mode. The SBC will monitor the microcontroller supply current to ensure that no unobserved phases occur while the watchdog is disabled and the microcontroller is running. The watchdog will remain active until the supply current drops below $I_{thL(V1)}$, when it will be disabled.

Should the current increase to $I_{thH(V1)}$ (e.g. as result of a microcontroller wake-up from application specific hardware) the watchdog will start operating again with the previously used time-out period. If the watchdog is not triggered correctly, a system reset will occur and the SBC will enter Start-up mode.

If Standby mode is entered from Normal mode with the selected watchdog OFF option, the watchdog will use the maximum time-out as defined for Standby mode until the supply current drops below the current detection threshold; the watchdog is now OFF. If the current increases again, the watchdog will be activated immediately, again using the maximum watchdog time-out period. If the watchdog OFF option is selected during Standby mode, the watchdog period last used will define the time for the supply current to fall below the current detection threshold. This allows the user to align the current supervisor function with the requirements of the application.

Generally, the microcontroller can be activated from Standby mode via a system reset or via an interrupt without reset. This allows for the implementation of differentiated start-up behavior from Standby mode, depending on the needs of the application:

- If the watchdog is still running during Standby mode, it can be used for cyclic wake-up behavior of the system. A dedicated Watchdog Time-out Interrupt Enable (WTIE) bit allows the microcontroller to decide whether to receive an interrupt or a hardware reset upon overflow. The interrupt option will be cleared in hardware automatically with each watchdog overflow to ensure that a failing main routine is detected while the interrupt service is still operating. So the application software must set the interrupt behavior before each standby cycle begins.
- Any wake-up via the CAN-bus together with a local wake-up event will force a system reset event or generate an interrupt to the microcontroller. So it is possible to exit Standby mode without performing a system reset if necessary.

When an interrupt event occurs, the application software has to read the Interrupt register within $t_{RSTN(INT)}$. Otherwise a fail-safe system reset is forced and Start-up mode will be entered. If the application has read out the Interrupt register within the specified time, it can decide whether to switch to Normal mode via an SPI access or to remain in Standby mode.

The following operations are possible from Standby mode:

- Cyclic wake-up by the watchdog via an interrupt signal to the microcontroller (the microcontroller is triggered periodically and checked for the correct response)
- Cyclic wake-up by the watchdog via a reset signal (a reset is performed periodically; the SBC provides information about the reset source to allow different start sequences after reset)
- Wake-up by activity on the CAN-bus via an interrupt signal to the microcontroller
- Wake-up by bus activity on the CAN-bus via a reset signal
- Wake-up by increasing the microcontroller supply current without a reset signal (where a stable supply is needed for the microcontroller RAM contents to remain valid and wake-up from an external application not connected to the SBC)
- Wake-up by increasing the microcontroller supply current with a reset signal
- Wake-up due to a falling edge at pin WAKE forcing an interrupt to the microcontroller
- Wake-up due to a falling edge at pin WAKE forcing a reset signal

6.2.6 Sleep mode

In Sleep mode the microcontroller power supply (V1) and the INH/LIMP-controlled external supplies are switched off entirely, resulting in minimum system power consumption. In this mode, the watchdog runs in Time-out mode or is completely off.

Entering Sleep mode results in an immediate LOW level on pin RSTN, stopping all microcontroller operations. The INH/LIMP output is floating in parallel and pin V1 is disabled. Only pin SYSINH can remain active to support the V2 voltage supply (if bit V2C is set; see [Table 12](#)). V3 can also be ON, OFF or in Cyclic mode to supply external wake-up switches.

If the watchdog is not disabled by software, it will continue to run and will force a system reset once the programmed watchdog period has expired. The SBC then enters Start-up mode and pin V1 becomes active again. This behavior can be used to implement cyclic wake-up from Sleep mode.

Depending on the application, the following operations can be selected from Sleep mode:

- Cyclic wake-up by the watchdog (only in Time-out mode); a reset is performed periodically, the SBC provides information about the reset source to allow the microcontroller to choose between different start up sequences after reset
- Wake-up by activity on the CAN-bus or falling edge on pin WAKE
- An overload on V3, only if V3 is in a cyclic or a continuously ON mode

6.2.7 Flash mode

Flash mode can only be entered from Normal mode by entering a specific Flash mode entry sequence. This fail-safe control sequence comprises three consecutive write accesses to the Mode register, within the legal windows of the watchdog, using the operating mode codes 111, 001 and 111 respectively. Once this sequence has been received, the SBC will enter Start-up mode and perform a system reset using the related reset source information (bits RSS[3:0] = 0110).

Once in Start-up mode the application software has to write Operating Mode code 011 to the Mode register within $t_{WD(\text{init})}$ to initiate a transition to Flash mode. This causes a successfully received hardware reset (handshake between the SBC and the microcontroller) to be fed back. The transition from Start-up mode to Flash mode can only occur once after the Flash entry sequence has been completed.

The application can choose not to enter Flash mode but instead return to Normal mode by using the Operating Mode code 101 for handshaking. This erases the Flash mode entry sequence.

The watchdog behavior in Flash mode is similar to its time-out behavior in Standby mode, but Operating Mode code 111 must be used for serving the watchdog. If this code is not used or if the watchdog overflows, the SBC will immediately force a reset and a transition to Start-up mode. Operating Mode code 110 (leave Flash mode) is used to correctly exit Flash mode. This results in a system reset with the corresponding reset source information. Other Mode register codes will cause a forced reset with reset source code 'illegal Mode register code'.

6.3 On-chip oscillator

The on-chip oscillator provides the clock signal for all digital functions and is the timing reference for the on-chip watchdog and the internal timers.

If the on-chip oscillator frequency is too low or the oscillator is not running at all, there is an immediate transition to Fail-safe mode. The SBC will stay in Fail-safe mode until the oscillator has recovered to its normal frequency and the system receives a wake-up event.

6.4 Watchdog

The watchdog provides the following timing functions:

- Start-up mode; needed to give the software the opportunity to initialize the system
- Window mode; detects 'too early' and 'too late' accesses in Normal mode
- Time-out mode; detects a 'too late' access, can also be used to restart or interrupt the microcontroller from time to time (cyclic wake-up function)
- OFF mode; fail-safe shutdown during operation prevents any blind spots occurring in the system supervision

The watchdog is clocked directly by the on-chip oscillator.

To guarantee fail-safe control of the watchdog via the SPI, all watchdog accesses are coded with redundant bits. Therefore, only certain codes are allowed for a proper watchdog service.

The following corrupted watchdog accesses result in an immediate system reset:

- Illegal watchdog period coding; only ten different codes are valid
- Illegal operating mode coding; only six different codes are valid

Any microcontroller-driven mode change is synchronized with a watchdog access by reading the mode information and the watchdog period information from the same register. This facilitates easy software flow control with defined watchdog behavior when switching between different software modules.

6.4.1 Watchdog start-up behavior

Following any reset event, the watchdog is used to monitor the ECU start-up procedure. It checks the behavior of the RSTN pin for clamping conditions or an interrupted reset wire. If the watchdog is not properly served within $t_{WD(init)}$, another reset is forced and the monitoring procedure is restarted. If the watchdog is again not properly served, the system enters Fail-safe mode (see also [Figure 3](#), Start-up mode and Restart mode).

6.4.2 Watchdog window behavior

When the SBC enters Normal mode, the Window mode of the watchdog is activated. This ensures that the microcontroller operates within the required speed window; an operation that is too fast or too slow will be detected. Watchdog triggering using Window mode is illustrated in [Figure 4](#).

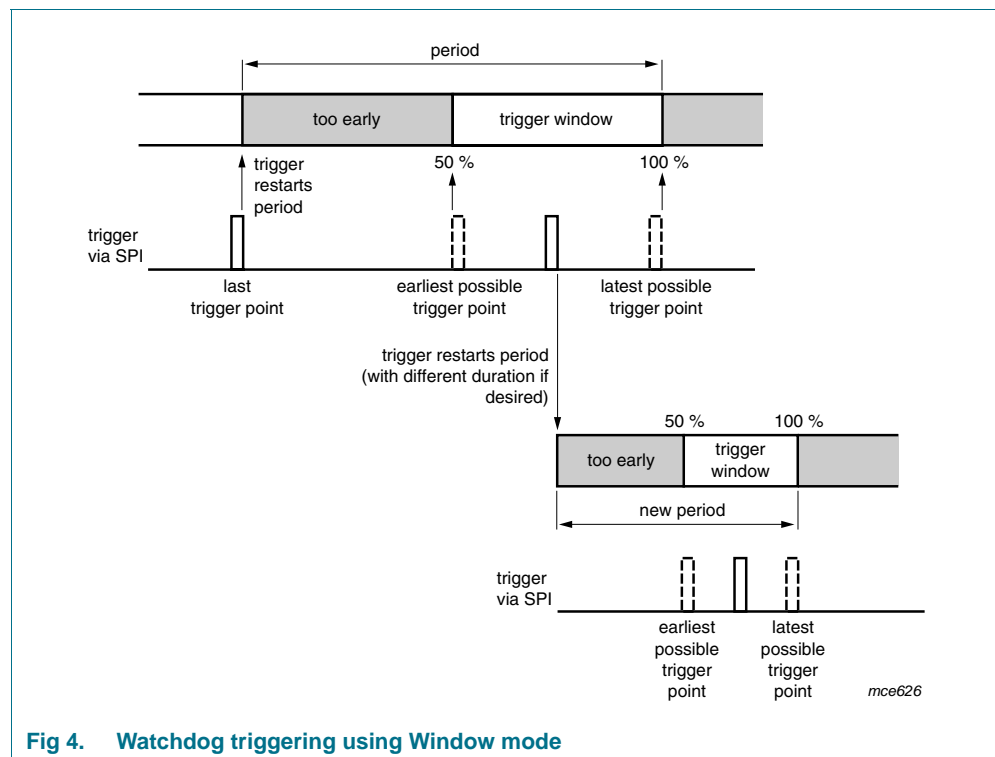

The SBC provides 10 different period timings, scalable with a 4-factor watchdog prescaler. The period can be changed within any valid trigger window. Whenever the watchdog is triggered within the window time frame, the timer will be reset to start a new period.

The watchdog window is defined to be between 50 % and 100 % of the nominal programmed watchdog period. Any 'too early' or 'too late' watchdog access or incorrect Mode register code access will result in an immediate system reset, when the SBC will revert to Start-up mode.

6.4.3 Watchdog time-out behavior

When the SBC is in Standby, Sleep or Flash mode, the active watchdog operates in Time-out mode. The watchdog has to be triggered within the programmed time frame (see [Figure 5](#)). Time-out mode can be used to generate cyclic wake-up events for the host microcontroller from Standby and Sleep modes.

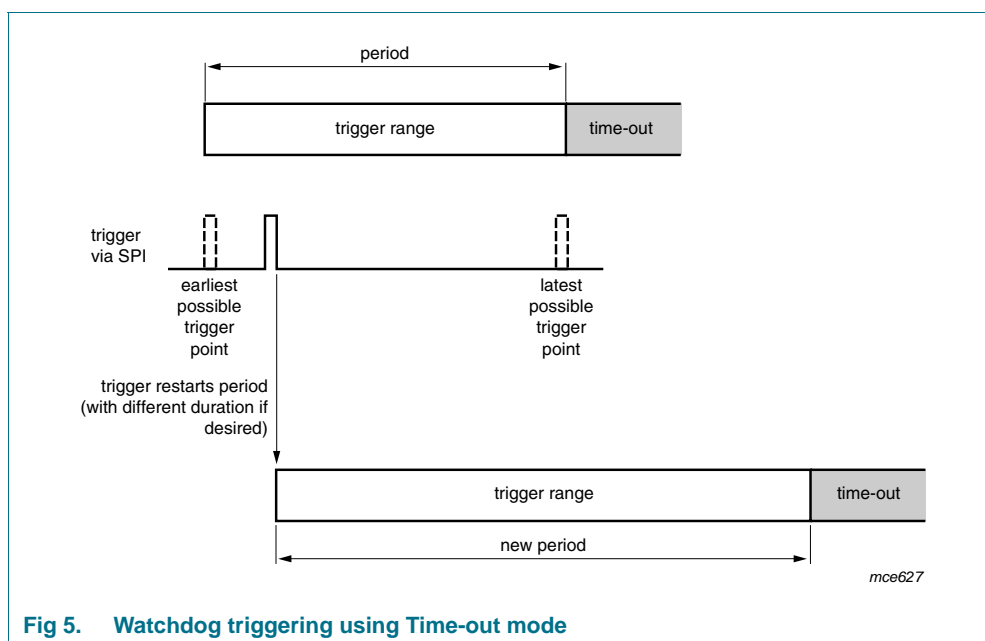

Fig 5. Watchdog triggering using Time-out mode

In Standby and Flash modes, the nominal periods can be changed with any SPI access to the Mode register.

Any illegal watchdog trigger code results in an immediate system reset, when the SBC will revert to Start-up mode.

6.4.4 Watchdog OFF behavior

In Standby and Sleep modes, the watchdog can be switched off entirely. For fail-safe reasons this is only possible if the microcontroller has halted program execution. To ensure that there is no continuing program execution, the V1 supply current is monitored by the SBC while the watchdog is switched off.

When selecting the watchdog OFF code, the watchdog remains active until the microcontroller supply current has dropped below the current monitoring threshold $I_{thL(V1)}$. Once the supply current has dropped below this threshold, the watchdog stops at the end of the watchdog period. The watchdog will remain active as long as the supply current remains above the monitoring threshold.

If the microcontroller supply current rises above $I_{thH(V1)}$ while the watchdog is OFF, the watchdog will be restarted using the watchdog period last used and, if enabled, a watchdog restart interrupt will be generated.

In the case of a direct mode change to Standby with watchdog OFF selected, the longest possible watchdog period is used. It should be noted that V1 current monitoring is not active in Sleep mode.

6.5 System reset

The reset function of the UJA1066 provides two signals to deal with reset events:

- RSTN; the global ECU system reset
- EN; a fail-safe global enable signal

6.5.1 RSTN pin

The system reset pin (RSTN) is a bidirectional input/output. RSTN is active LOW with a selectable pulse length triggered by the following events (see [Figure 3](#)):

- Power-on (first battery connection) or V_{BAT42} below power-on reset threshold voltage
- Low V1 supply
- V1 current above threshold in Standby mode while watchdog OFF behavior is selected
- V3 is down due to short-circuit condition in Sleep mode
- RSTN externally forced LOW, falling edge event
- Successful preparation for Flash mode completed
- Successful exit from Flash mode
- Wake-up from Standby mode via pins CAN or WAKE if programmed accordingly, or any wake-up event from Sleep mode
- Wake-up event from Fail-safe mode
- Watchdog trigger failure (too early, overflow, wrong code)
- Illegal mode code applied via SPI
- Interrupt not served within $t_{RSTN(INT)}$

The source of the reset event can be determined by reading the RSS[3:0] bits in the System Status registers.

The SBC will lengthen a reset event, to 1 ms or 20 ms, to ensure that external hardware is properly reset. When the battery is connected initially, a short power-on reset of 1 ms is generated once voltage V1 is present. Once started, the microcontroller can set the Reset Length Control (RLC) bit in the System Configuration register; this allows the reset pulse to be adjusted for future reset events. When this bit is set, reset events are lengthened to 20 ms. Fail-safe behavior ensures that this bit is set automatically (to 20 ms) in Restart and Fail-safe modes. This mechanism guarantees that an erroneously shortened reset pulse will still restart the microcontroller, at least within the second trial period by using the long reset pulse.

The behavior of pin RSTN is illustrated in [Figure 6](#). The duration of t_{RSTNL} depends on the setting of bit RLC (which defines the reset length). Once an external reset event has been detected, the system controller enters Start-up mode. The watchdog now starts to monitor pin RSTN as illustrated in [Figure 7](#). If the RSTN pin is not released in time, the SBC will enter Fail-safe mode (see [Figure 3](#)).

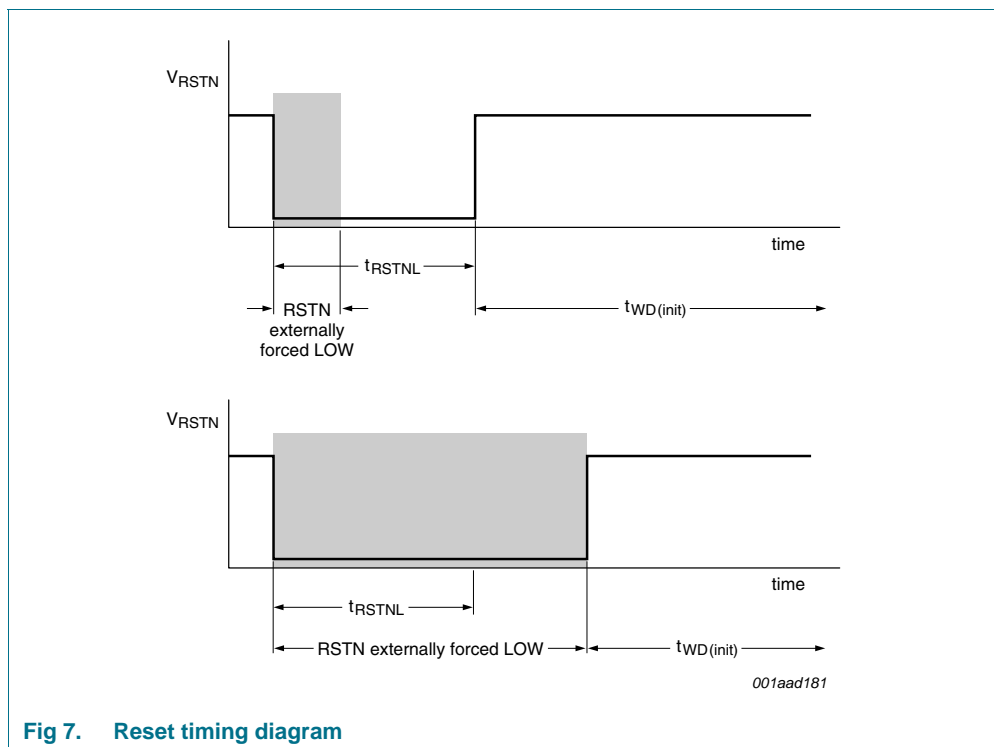
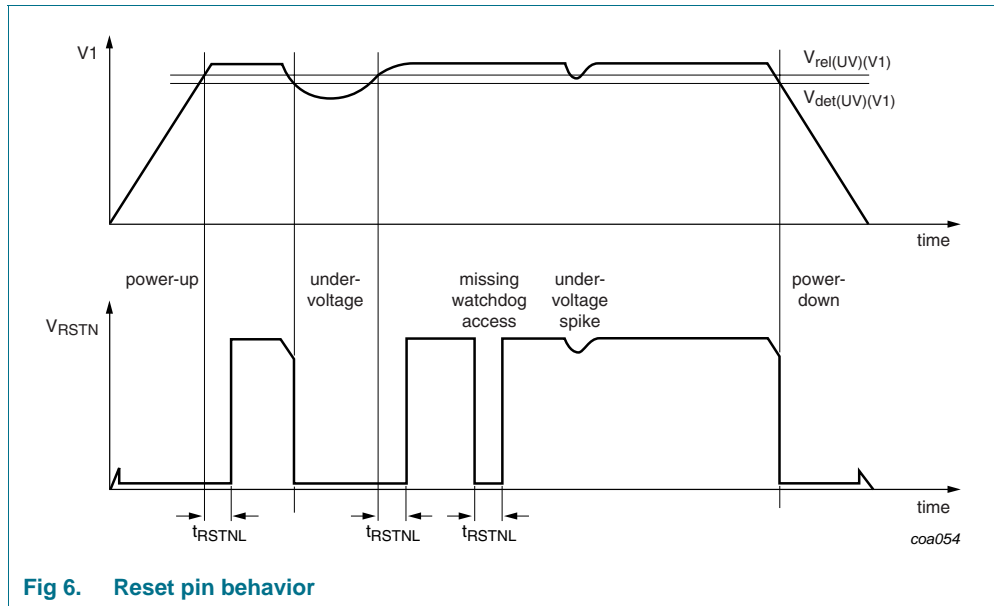

Pin RSTN is monitored for a continuously clamped LOW condition. If the SBC pulls RSTN HIGH, but it remains LOW for longer than $t_{RSTN(CL)}$, the SBC immediately enters Fail-safe mode since this indicates an application failure.

The SBC also detects if pin RSTN is clamped HIGH. If the SBC pulls RSTN LOW, but it remains HIGH for longer than $t_{RSTN(CH)}$, the SBC immediately falls back to Fail-safe mode since the microcontroller can no longer be reset. On entering Fail-safe mode, the V1 voltage regulator shuts down and the microcontroller stops running.

Additionally, chattering reset signals are handled by the SBC in such a way that the system safely falls back to Fail-safe mode with the lowest possible power consumption.

6.5.2 EN output

Pin EN can be used to control external hardware, such as power components, or as a general purpose output if the system is running properly. During all reset events, when pin RSTN is pulled LOW, the EN control bit is cleared and pin EN is forced LOW. It will remain LOW after pin RSTN is released. In Normal and Flash modes, the microcontroller can set the EN control bit via the SPI. This releases pin EN, which goes HIGH.

6.6 Power supplies

6.6.1 BAT14, BAT42 and SYSINH

The SBC contains two supply pins, BAT42 and BAT14. BAT42 supplies most of the SBC while BAT14 only supplies the linear voltage regulators and the INH/LIMP output pin. This supply architecture facilitates different supply strategies, including the use of external DC-to-DC converters controlled by pin SYSINH.

6.6.1.1 SYSINH output

The SYSINH output is a high-side switch from BAT42. It is activated whenever the SBC requires a supply voltage for pin BAT14 (e.g. when V1 or V2 is on; see [Figure 3](#) and [Figure 8](#)). Otherwise pin SYSINH is left floating. Pin SYSINH can be used, for example, to control an external step-down voltage regulator to BAT14, to reduce power consumption in low-power modes.

6.6.2 SENSE input

The SBC has a dedicated SENSE pin for dynamic monitoring of the battery contact in an ECU. Connecting this pin in front of the polarity protection diode in an ECU provides an early warning of a battery becoming disconnected.

6.6.3 Voltage regulators V1 and V2

The UJA1066 contains two independent voltage regulators supplied from pin BAT14. Regulator V1 is intended to supply the microcontroller. Regulator V2 is reserved for the high-speed CAN transceiver.

6.6.3.1 Voltage regulator V1

The voltage at V1 is continuously monitored to ensure a system reset signal is generated when an undervoltage event occurs. A hardware reset is forced if the output voltage at V1 falls below one of the three programmable thresholds.

A dedicated V1 supply comparator (V1 Monitor) monitors V1 for undervoltage events ($V_{O(V1)} < V_{UV(VF1)}$). This allows the application to receive a supply warning interrupt if one of the lower V1 undervoltage reset thresholds has been selected (see [Table 13](#)).

Regulator V1 is overload protected. The maximum output current available at pin V1 depends on the voltage applied at pin BAT14 (see [Section 9 “Static characteristics”](#)). Total power dissipation should be taken into account for thermal reasons.

6.6.3.2 Voltage regulator V2

Voltage regulator V2 provides a 5 V supply for the CAN transmitter. An external buffer capacitor should be connected to pin V2.

V2 is controlled autonomously by the CAN transceiver control system and is activated on any detected CAN-bus activity, or if the CAN transceiver is enabled by the application microcontroller. V2 is short-circuit protected and will be disabled in an overload situation. Dedicated bits in the System Diagnosis register and the Interrupt register provide V2 status feedback to the application.

In addition to being controlled autonomously by the CAN transceiver control system, V2 can be activated manually via bit V2C (in [Table 12](#)). This allows V2 to be used in applications when CAN is not actively used (e.g. while CAN is off-line). In general, V2 should not be used with other application hardware while CAN is in use.

If regulator V2 is unable to start up within the V2 clamped LOW time ($> t_{V2(CLT)}$), or if a short circuit is detected while V2 is active, V2 is disabled and bit V2D in the Diagnosis register is cleared (see [Table 8](#)). In addition, bit CTC in the Physical Layer register is set and the V2C bit is cleared (see in [Table 12](#)).

Any of the following events will reactivate regulator V2:

- Clearing bit CTC while CAN is in Active mode
- Wake up via CAN while CAN is not in Active mode
- Setting bit V2C
- Entering CAN Active mode

6.6.4 Switched battery output V3

V3 is a high-side switched BAT42-related output which is used to drive external loads such as wake-up switches or relays. The features of V3 are as follows:

- Three application controlled modes of operation; ON, OFF and Cyclic mode.
- Two different cyclic modes allow for the supply of external wake-up switches; these switches are powered intermittently, thus reducing system power consumption when a switch is continuously active; the wake-up input of the SBC is synchronized with the V3 cycle time.
- The switch is protected against current overloads. If V3 is overloaded, pin V3 is automatically disabled. The corresponding Diagnosis register bit (V3D) is reset and a VFI interrupt is generated (if enabled). During Sleep mode, a wake-up is forced and the corresponding reset source code (0100) can be read via the RSS bits of the System Status register. This signals that the wake-up source via V3 supplied wake-up switches has been lost.

6.7 CAN transceiver

The integrated high-speed CAN transceiver on the UJA1066 is an advanced ISO 11898-2 and ISO 11898-5 compliant transceiver. In addition to standard high-speed CAN transceiver features, the UJA1066 transceiver provides the following:

- Enhanced error handling and reporting of bus and RXD/TXD failures; these failures are separately identified in the System Diagnosis register
- Integrated autonomous control system for determining the mode of the CAN transceiver
- Ground shift detection with two selectable warning levels, to detect possible local ground problems before the CAN communication is affected
- On-line Listen mode with global wake-up message filter allows partial networking
- Bus connections are truly floating when power is off

6.7.1 Mode control

The CAN transceiver controller supports four operating modes: Active mode, On-line mode, On-line Listen mode and Off-line mode; see [Figure 8](#).

Two dedicated CAN status bits (CANMD) in the Diagnosis register are provided to indicate the operating mode.

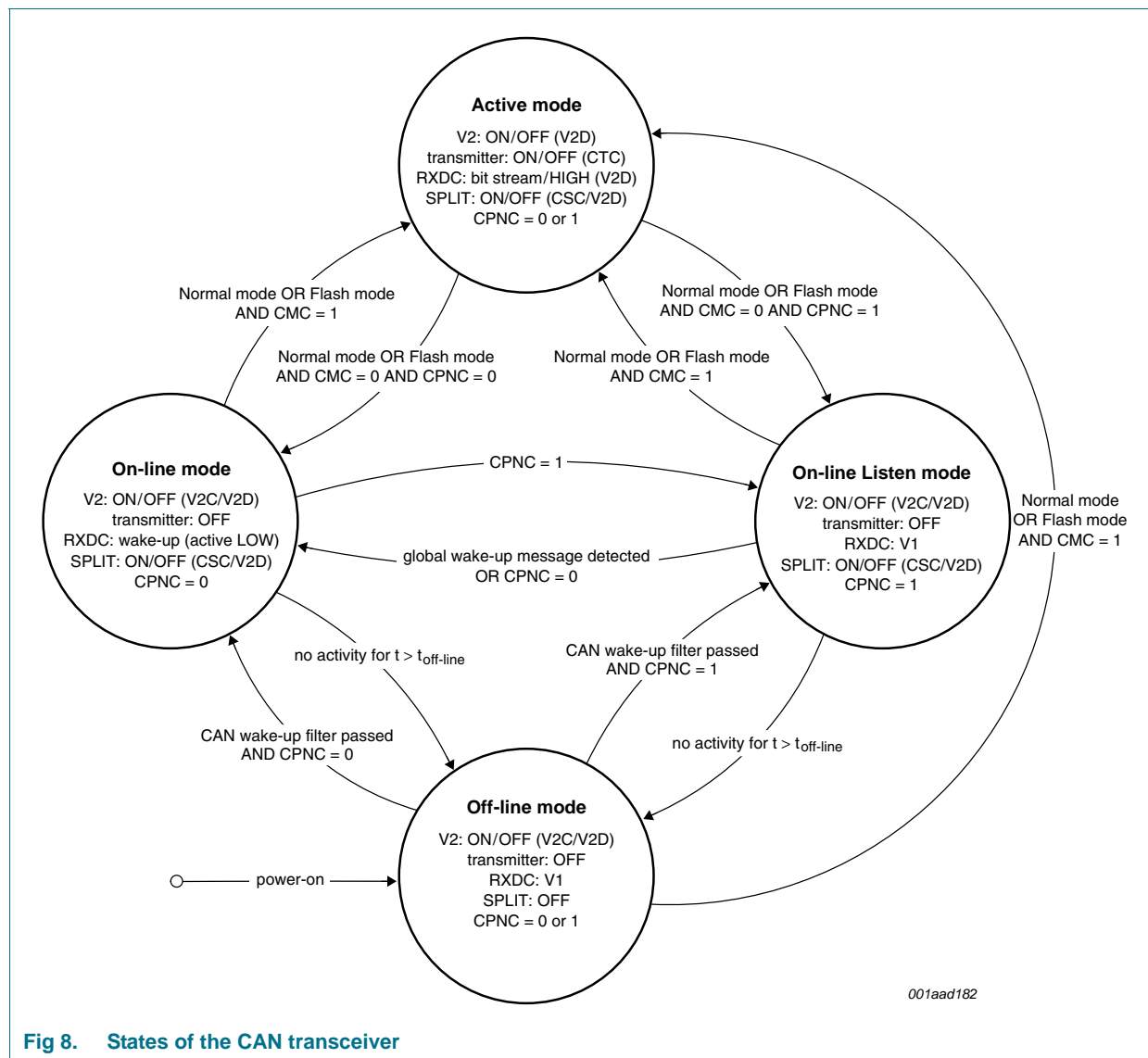

Fig 8. States of the CAN transceiver

6.7.1.1 Active mode

In Active mode, the CAN transceiver can transmit data to and receive data from the CAN-bus. The CMC bit in the Physical Layer register must be set and the SBC must be in Normal or Flash mode before the transceiver can enter Active mode. In Active mode, voltage regulator V2 is activated automatically.

The CTC bit can be used to set the CAN transceiver to a Listen-only mode. The transmitter output stage is disabled in this mode.

After an overload condition on voltage regulator V2, the CTC bit must be cleared to reactivate the CAN transmitter.

On leaving Active mode, the CAN transmitter is disabled and the CAN receiver monitors the CAN-bus for a valid wake-up. The CAN termination is then working autonomously.

6.7.1.2 On-line mode

In On-line mode the CAN-bus pins and pin SPLIT (if enabled) are biased to the normal levels. The CAN transmitter is deactivated and RXDC reflects the CAN wake-up status. A CAN wake-up event is signalled to the microcontroller by clearing RXDC.

If the bus stays continuously dominant or recessive for the Off-line time ($t_{\text{off-line}}$), the Off-line state will be entered.

6.7.1.3 On-line Listen mode

On-line Listen mode is similar to On-line mode, but all activity on the CAN-bus, with the exception of a special global wake-up request, is ignored. The global wake-up request is described in [Section 6.7.2](#). Pin RXDC is held HIGH.

6.7.1.4 Off-line mode

Off-line mode is the low-power mode of the CAN transceiver. The CAN transceiver is disabled to save supply current and is high-ohmic terminated to ground.

The CAN off-line time is programmable in two steps with the CAN Off-line Timer Control (COTC) bit. When entering On-line (Listen) mode from Off-line mode the CAN off-line time is temporarily extended to $t_{\text{off-line(Ext)}}$.

6.7.2 CAN wake-up

To wake-up the UJA1066 via CAN it is necessary to distinguish between a conventional wake-up and a global wake-up in case partial networking is enabled (bit CPNC = 1).

A dominant, recessive, dominant, recessive signal on the CAN-bus is needed to pass the wake-up filter for a conventional wake-up; see [Figure 9](#).

For a global wake-up from On-line Listen mode, two distinct CAN data patterns are required:

- In the initial message: C6 - EE - EE - EE - EE - EE - EE - EF (hexadecimal values)
- In the global wake-up message: C6 - EE - EE - EE - EE - EE - EE - 37 (hexadecimal values)

The second pattern must be received within t_{timeout} after receiving the first pattern. Any CAN-ID can be used with these data patterns.

If the CAN transceiver enters On-line Listen mode directly from Off-line mode, the global wake-up message is sufficient to wake-up the SBC. This pattern must be received within t_{timeout} after entering On-line Listen mode. Should t_{timeout} elapse before the global wake-up message is received, then both messages are required for a CAN wake-up.

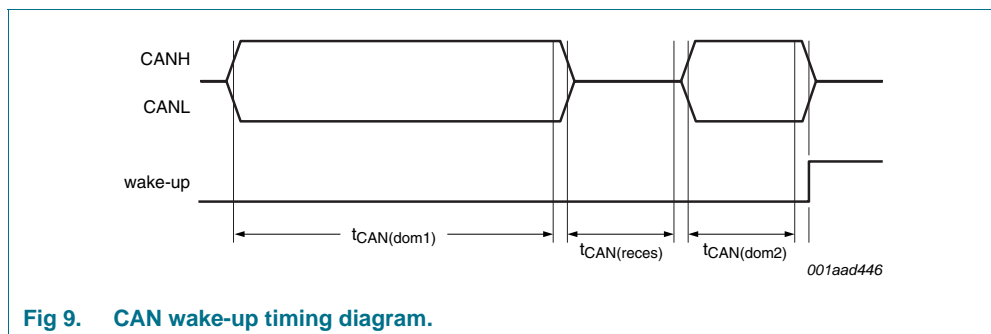

6.7.3 Termination control

In Active mode, On-line mode and On-line Listen mode, CANH and CANL are terminated to $0.5 \times V_{V2}$ via R_i . In Off-line mode CANH and CANL are terminated to GND via R_i . If V_2 is disabled due to an overload condition both pins become floating.

6.7.4 Bus, RXD and TXD failure detection

The UJA1066 can distinguish between bus, RXD and TXD failures as indicated in [Table 3](#).

All failures are signalled individually in the CANFD bits in the System Diagnosis register. Any change (detection and recovery) generates a CANFI interrupt to the microcontroller, if the interrupt is enabled.

Table 3. CAN-bus, RXD and TXD failure detection

| Failure | Description |
|------------|---|
| HxHIGH | CANH short-circuit to V_{CC} , V_{BAT14} or V_{BAT42} |
| HxGND | CANH short-circuit to GND |
| LxHIGH | CANL short-circuit to V_{CC} , V_{BAT14} or V_{BAT42} |
| LxGND | CANL short-circuit to GND |
| HxL | CANH short-circuit to CANL |
| Bus dom | bus is continuously clamped dominant |
| TXDC dom | pin TXDC is continuously clamped dominant |
| RXDC reces | pin RXDC is continuously clamped recessive |
| RXDC dom | pin RXDC is continuously clamped dominant |

6.7.4.1 TXDC dominant clamping

If the TXDC pin is clamped dominant for longer than $t_{TXDC(dom)}$, the CAN transmitter will be disabled. After the TXDC pin becomes recessive, the transmitter is reactivated automatically when bus activity is detected or can be reactivated manually by setting and clearing the CTC bit.

6.7.4.2 RXDC recessive clamping

If the RXDC pin is clamped recessive while the CAN-bus is dominant, the CAN transmitter will be disabled. The transmitter will be reactivated automatically when RXDC becomes dominant or can be reactivated manually by setting and clearing the CTC bit.

6.7.4.3 GND shift detection

The SBC can detect ground shifts in reference to the CAN-bus. Two different ground shift detection levels can be selected with the GSTHC bit in the Configuration register. The failure can be read out in the System Diagnosis register. Any detected or recovered GND shift event is signalled via a GSI an interrupt, if enabled.

6.8 Inhibit and limp-home output

The INH/LIMP output pin is a 3-state output, which can be used either as an inhibit for an extra (external) voltage regulator or as a 'limp-home' output. The pin is controlled via bits ILEN and ILC in the System Configuration register; see [Figure 10](#).

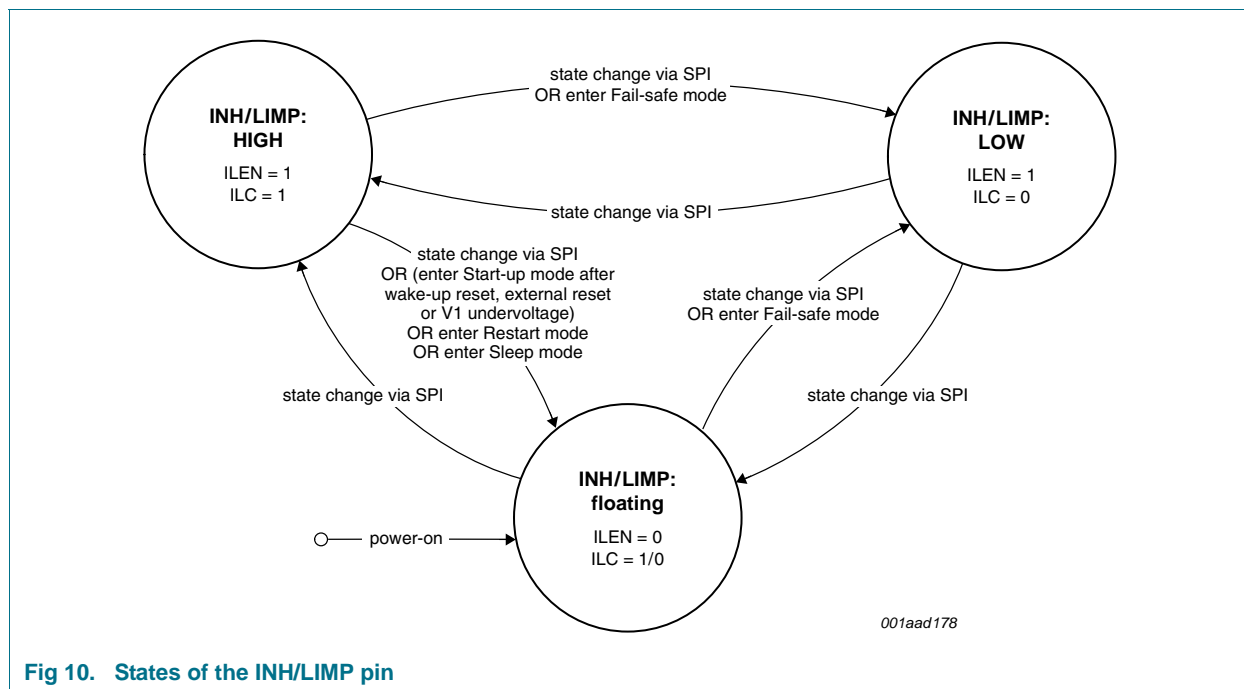

Fig 10. States of the INH/LIMP pin

When pin INH/LIMP is used as an inhibit output, a pull-down resistor to GND ensures a default LOW level. The pin can be set HIGH according to the state diagram.

When pin INH/LIMP is used as limp-home output, a pull-up resistor to V_{BAT42} ensures a default HIGH level. The pin is automatically set LOW when the SBC enters Fail-safe mode.

6.9 Wake-up input

The WAKE input comparator is triggered by negative edges on pin WAKE. Pin WAKE has an internal pull-up resistor to BAT42. It can be operated in two sampling modes, which are selected via the WAKE Sample Control bit (WSC in [Table 11](#)):

- Continuous sampling (with an internal clock) if the bit is set
- Sampling synchronized to the cyclic behavior of V3 if the bit is cleared; see [Figure 11](#). This is to minimize bias current in the external switches during low-power operation. Two repetition times are possible, 16 ms and 32 ms.

If V3 is continuously ON, the WAKE input will be sampled continuously, regardless of the level of bit WSC.

The dedicated bits Edge Wake-up Status (EWS) and WAKE Level Status (WLS) in the System Status register reflect the actual status of pin WAKE. The WAKE port can be disabled by clearing bit WEN in the System Configuration register.

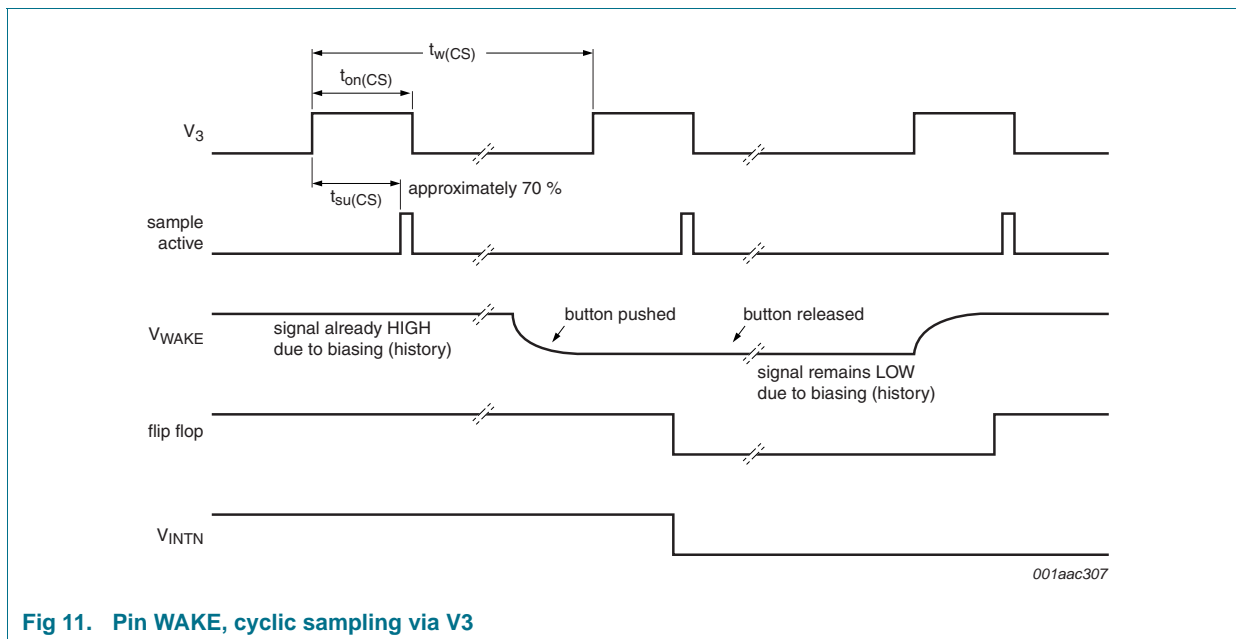

Fig 11. Pin WAKE, cyclic sampling via V3

6.10 Interrupt output

Pin INTN is an open-drain interrupt output. It is forced LOW when at least one bit in the Interrupt register is set. All bits are cleared when the Interrupt register is read. The Interrupt register is also cleared during a system reset (RSTN LOW).

As the microcontroller operates typically with an edge-sensitive interrupt port, pin INTN will be HIGH for at least t_{INTN} after each readout of the Interrupt register. If no further interrupts are generated within t_{INTNH} , INTN will remain HIGH; otherwise it will go LOW again.

To prevent the microcontroller being slowed down by repetitive interrupts, some interrupts are only allowed to occur once per watchdog period in Normal mode; see [Section 6.12.7](#).

If an interrupt is not read out within $t_{RSTN(INT)}$, a system reset is performed.

6.11 Temperature protection

The temperature of the SBC chip is monitored as long as the microcontroller voltage regulator V1 is active. To avoid an unexpected shutdown of the application by the SBC, temperature protection will not switch off any part of the SBC or activate a defined system stop of its own accord. If the temperature is too high, an OTI interrupt is generated (if enabled) and the corresponding status bit (TWS) is set. The microcontroller can then decide whether to switch off parts of the SBC to decrease the chip temperature.

6.12 SPI interface

The Serial Peripheral Interface (SPI) provides the communication link with the microcontroller, supporting multi-slave and multi-master operation. The SPI is configured for full duplex data transfer, so status information is returned when new control data is shifted in. The interface also offers a read-only access option, allowing registers to be read back by the application without changing the register content.

The SPI uses four interface signals for synchronization and data transfer:

- SCS - SPI chip select; active LOW
- SCK - SPI clock; default level is LOW due to low-power concept
- SDI - SPI data input
- SDO - SPI data output; floating when pin SCS is HIGH

Bit sampling is performed on the falling clock edge and data is shifted on the rising clock edge; see [Figure 12](#).

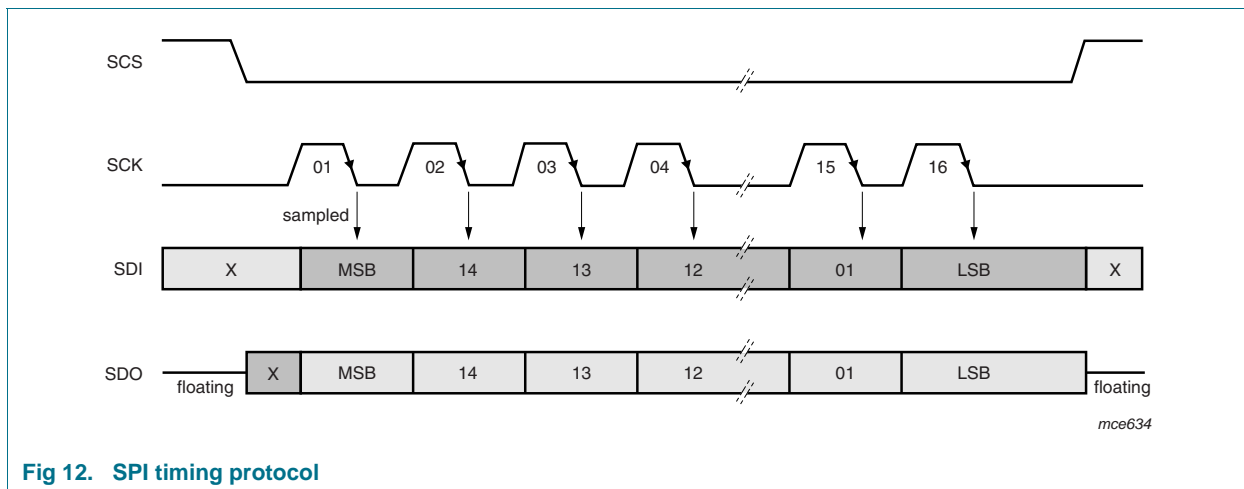

Fig 12. SPI timing protocol

To protect against wrong or illegal SPI instructions, the SBC detects the following SPI failures:

- SPI clock count failure (wrong number of clock cycles during one SPI access): only 16 clock periods are allowed during an SCS cycle. Any deviation from the 16 clock cycles results in an SPI failure interrupt, if enabled. The access is ignored by the SBC. In Start-up and Restart modes, a reset is forced instead of an interrupt.
- Forbidden mode changes according to [Figure 3](#) result in an immediate system reset
- Illegal Mode register code. Undefined operating mode or watchdog period coding results in an immediate system reset; see [Section 6.12.3](#).

6.12.1 SPI register mapping

Any control bit that can be set by software can be read by the application. This facilitates software debugging and allows control algorithms to be implemented.

Watchdog serving and mode setting are performed within the same access cycle; this allows an SBC mode change to occur only while serving the watchdog.

Each register contains 12 data bits; the other 4 bits are used for register selection and read/write definition.

6.12.2 Register overview

The SPI interface provides access to all SBC registers; see [Table 4](#). The first two bits (A1 and A0) of the message header define the register address. The third bit is the read register select bit (RRS) used to select one of two feedback registers. The fourth bit (RO) allows 'read-only' access to one of the feedback registers. Which of the SBC registers can be accessed also depends on the SBC operating mode.

Table 4. Register overview

| Register address bits (A1, A0) | Operating mode | Write access (RO = 0) | Read access (RO = 0 or RO = 1) | |
|--------------------------------|---|---------------------------------|--|-------------------------------------|
| | | | Read Register Select (RRS) bit = 0 | Read Register Select (RRS) bit = 1 |
| 00 | all modes | Mode register | System Status register | System Diagnosis register |
| 01 | Normal mode; Standby mode; Flash mode | Interrupt Enable register | Interrupt Enable Feedback register | Interrupt register |
| | Start-up mode; Restart mode | Special Mode register | Interrupt Enable Feedback register | Special Mode Feedback register |
| 10 | Normal mode; Standby mode | System Configuration register | System Configuration Feedback register | General Purpose Feedback register 0 |
| | Start-up mode; Restart mode; Flash mode | General Purpose register 0 | System Configuration Feedback register | General Purpose Feedback register 0 |
| 11 | Normal mode; Standby mode | Physical Layer Control register | Physical Layer Control Feedback register | General Purpose Feedback register 1 |
| | Start-up mode; Restart mode; Flash mode | General Purpose register 1 | Physical Layer Control Feedback register | General Purpose Feedback register 1 |

6.12.3 Mode register

The Mode register is used to define and re-trigger the watchdog and to select the SBC operating mode. The Mode register also contains the global enable output bit (EN) and the Software Development Mode (SDM) control bit. Cyclic access to the Mode register is required during system operation to serve the watchdog. This register can be written to in all modes.

At system start-up, the Mode register must be written to within $t_{WD(init)}$ of pin RSTN being released (HIGH-level on pin RSTN). Any write access is checked for proper watchdog and system mode coding. If an illegal code is detected, access is ignored by the SBC and a system reset is forced in accordance with the state diagram of the system controller; see [Figure 3](#).

Table 5. Mode register bit description (bits 15 to 12 and 5 to 0)

| Bit | Symbol | Description | Value | Function |
|-----------|----------|-----------------------------|-------|---|
| 15 and 14 | A1, A0 | register address | 00 | select Mode register |
| 13 | RRS | Read Register Select | 1 | read System Diagnosis register |
| | | | 0 | read System Status register |
| 12 | RO | Read Only | 1 | read selected register without writing to Mode register |
| | | | 0 | read selected register and write to Mode register |
| 11 to 6 | NWP[5:0] | see Table 6 | | |
| 5 to 3 | OM[2:0] | Operating Mode | 001 | Normal mode |
| | | | 010 | Standby mode |
| | | | 011 | initialize Flash mode ^[1] |
| | | | 100 | Sleep mode |
| | | | 101 | initialize Normal mode |
| | | | 110 | leave Flash mode |
| | | | 111 | Flash mode ^[1] |
| 2 | SDM | Software Development Mode | 1 | Software development mode enabled ^[2] |
| | | | 0 | normal watchdog, interrupt, reset monitoring and fail-safe behavior |
| 1 | EN | Enable | 1 | EN output pin HIGH |
| | | | 0 | EN output pin LOW |
| 0 | - | reserved | 0 | reserved for future use; should remain cleared to ensure compatibility with future functions which might use this bit |

[1] Flash mode can be entered only with the watchdog service sequence 'Normal mode to Flash mode to Normal mode to Flash mode', while observing the watchdog trigger rules. With the last command of this sequence the SBC forces a system reset, and enters Start-up mode to prepare the microcontroller for flash memory download. The four RSS bits in the System Status register reflect the reset source information, confirming the Flash entry sequence. By using the Initializing Flash mode (within $t_{WD(init)}$ after system reset) the SBC will now successfully enter Flash mode.

[2] See [Section 6.13.1](#).

Table 6. Mode register bit description (bits 11 to 6)^[1]

| Bit | Symbol | Description | Value | Time | | | |
|---------|----------|--|---------|------------------|--------------------|-----------------|--------------------|
| | | | | Normal mode (ms) | Standby mode (ms) | Flash mode (ms) | Sleep mode (ms) |
| 11 to 6 | NWP[5:0] | Nominal Watchdog Period WDPRE = 00 (as set in the Special Mode register) | 00 1001 | 4 | 20 | 20 | 160 |
| | | | 00 1100 | 8 | 40 | 40 | 320 |
| | | | 01 0010 | 16 | 80 | 80 | 640 |
| | | | 01 0100 | 32 | 160 | 160 | 1024 |
| | | | 01 1011 | 40 | 320 | 320 | 2048 |
| | | | 10 0100 | 48 | 640 | 640 | 3072 |
| | | | 10 1101 | 56 | 1024 | 1024 | 4096 |
| | | | 11 0011 | 64 | 2048 | 2048 | 6144 |
| | | | 11 0101 | 72 | 4096 | 4096 | 8192 |
| | | | 11 0110 | 80 | OFF ^[2] | 8192 | OFF ^[3] |
| | | Nominal Watchdog Period WDPRE = 01 (as set in the Special Mode register) | 00 1001 | 6 | 30 | 30 | 240 |
| | | | 00 1100 | 12 | 60 | 60 | 480 |
| | | | 01 0010 | 24 | 120 | 120 | 960 |
| | | | 01 0100 | 48 | 240 | 240 | 1536 |
| | | | 01 1011 | 60 | 480 | 480 | 3072 |
| | | | 10 0100 | 72 | 960 | 960 | 4608 |
| | | | 10 1101 | 84 | 1536 | 1536 | 6144 |
| | | | 11 0011 | 96 | 3072 | 3072 | 9216 |
| | | | 11 0101 | 108 | 6144 | 6144 | 12288 |
| | | | 11 0110 | 120 | OFF ^[2] | 12288 | OFF ^[3] |
| | | Nominal Watchdog Period WDPRE = 10 (as set in the Special Mode register) | 00 1001 | 10 | 50 | 50 | 400 |
| | | | 00 1100 | 20 | 100 | 100 | 800 |
| | | | 01 0010 | 40 | 200 | 200 | 1600 |
| | | | 01 0100 | 80 | 400 | 400 | 2560 |
| | | | 01 1011 | 100 | 800 | 800 | 5120 |
| | | | 10 0100 | 120 | 1600 | 1600 | 7680 |
| | | | 10 1101 | 140 | 2560 | 2560 | 10240 |
| | | | 11 0011 | 160 | 5120 | 5120 | 15360 |
| | | | 11 0101 | 180 | 10240 | 10240 | 20480 |
| | | | 11 0110 | 200 | OFF ^[2] | 20480 | OFF ^[3] |

Table 6. Mode register bit description (bits 11 to 6)^[1] ...continued

| Bit | Symbol | Description | Value | Time | | | |
|---------|----------|---|---------|------------------|--------------------|-----------------|--------------------|
| | | | | Normal mode (ms) | Standby mode (ms) | Flash mode (ms) | Sleep mode (ms) |
| 11 to 6 | NWP[5:0] | Nominal Watchdog Period WDPRE = 11 (as set in the Special Mode register) | 00 1001 | 14 | 70 | 70 | 560 |
| | | | 00 1100 | 28 | 140 | 140 | 1120 |
| | | | 01 0010 | 56 | 280 | 280 | 2240 |
| | | | 01 0100 | 112 | 560 | 560 | 3584 |
| | | | 01 1011 | 140 | 1120 | 1120 | 7168 |
| | | | 10 0100 | 168 | 2240 | 2240 | 10752 |
| | | | 10 1101 | 196 | 3584 | 3584 | 14336 |
| | | | 11 0011 | 224 | 7168 | 7168 | 21504 |
| | | | 11 0101 | 252 | 14336 | 14336 | 28672 |
| | | | 11 0110 | 280 | OFF ^[2] | 28672 | OFF ^[3] |

[1] The nominal watchdog periods are directly related to the SBC internal oscillator. The given values are valid for $f_{osc} = 512$ kHz.

[2] See [Section 6.4.4](#).

[3] The watchdog is immediately disabled on entering Sleep mode, with watchdog OFF behavior selected, because pin RSTN is immediately pulled LOW by the mode change. V1 is switched off after pulling pin RSTN LOW to guarantee a safe Sleep mode entry without dips on V1. See [Section 6.4.4](#).

6.12.4 System Status register

This register allows status information to be read back from the SBC. This register can be read in all modes.

Table 7. System Status register bit description

| Bit | Symbol | Description | Value | Function |
|-----------|--------|----------------------|-------|--|
| 15 and 14 | A1, A0 | register address | 00 | read System Status register |
| 13 | RRS | Read Register Select | 0 | |
| 12 | RO | Read Only | 1 | read System Status register without writing to Mode register |
| | | | 0 | read System Status register and write to Mode register |

Table 7. System Status register bit description ...continued

| Bit | Symbol | Description | Value | Function |
|---------|----------|----------------------------------|-------|---|
| 11 to 8 | RSS[3:0] | Reset Source ^[1] | 0000 | power-on reset; first connection of BAT42 or BAT42 below power-on voltage threshold or RSTN was forced LOW externally |
| | | | 0001 | cyclic wake-up out of Sleep mode |
| | | | 0010 | low V1 supply; V1 has dropped below the selected reset threshold |
| | | | 0011 | V1 current above threshold within Standby mode while watchdog OFF behavior and reset option (V1CMC bit) are selected |
| | | | 0100 | V3 voltage is down due to overload occurring during Sleep mode |
| | | | 0101 | SBC successfully left Flash mode |
| | | | 0110 | SBC ready to enter Flash mode |
| | | | 0111 | CAN wake-up event |
| | | | 1000 | reserved for SBCs with LIN transceiver |
| | | | 1001 | local wake-up event (via pin WAKE) |
| | | | 1010 | wake-up out of Fail-safe mode |
| | | | 1011 | watchdog overflow |
| | | | 1100 | watchdog not initialized in time; $t_{WD(init)}$ exceeded |
| | | | 1101 | watchdog triggered too early; window missed |
| | | | 1110 | illegal SPI access |
| | | | 1111 | interrupt not served within $t_{RSTN(INT)}$ |
| 7 | CWS | CAN Wake-up Status | 1 | CAN wake-up detected; cleared upon read |
| | | | 0 | no CAN wake-up |
| 6 | - | reserved | 0 | reserved for SBCs with LIN transceiver |
| 5 | EWS | Edge Wake-up Status | 1 | pin WAKE negative edge detected; cleared upon read |
| | | | 0 | pin WAKE no edge detected |
| 4 | WLS | WAKE Level Status | 1 | pin WAKE above threshold |
| | | | 0 | pin WAKE below threshold |
| 3 | TWS | Temperature Warning Status | 1 | chip temperature exceeds the warning limit |
| | | | 0 | chip temperature is below the warning limit |
| 2 | SDMS | Software Development Mode Status | 1 | Software Development mode on |
| | | | 0 | Software Development mode off |
| 1 | ENS | Enable Status | 1 | pin EN output activated (V1-related HIGH level) |
| | | | 0 | pin EN output released (LOW level) |
| 0 | PWONS | Power-on reset Status | 1 | power-on reset; cleared after a successfully entered Normal mode |
| | | | 0 | no power-on reset |

[1] The RSS bits are updated with each reset event and not cleared. The last reset event is captured.

6.12.5 System Diagnosis register

This register allows diagnostic information to be read back from the SBC. This register can be read in all modes.

Table 8. System Diagnosis register bit description

| Bit | Symbol | Description | Value | Function |
|-----------|-------------|------------------------|-------|--|
| 15 and 14 | A1, A0 | register address | 00 | read System Diagnosis register |
| 13 | RRS | Read Register Select | 1 | |
| 12 | RO | Read Only | 1 | read System Diagnosis register without writing to Mode register |
| | | | 0 | read System Diagnosis register and write to Mode register |
| 11 | GSD | Ground Shift Diagnosis | 1 | system GND shift is outside selected threshold |
| | | | 0 | system GND shift is within selected threshold |
| 10 to 7 | CANFD [3:0] | CAN Failure Diagnosis | 1111 | pin TXDC is continuously clamped dominant |
| | | | 1110 | pin RXDC is continuously clamped dominant |
| | | | 1100 | the bus is continuously clamped dominant |
| | | | 1101 | pin RXDC is continuously clamped recessive |
| | | | 1011 | reserved |
| | | | 1010 | reserved |
| | | | 1001 | pin CANH is shorted to pin CANL |
| | | | 1000 | pin CANL is shorted to V_{CC} , V_{BAT14} or V_{BAT42} |
| | | | 0111 | reserved |
| | | | 0110 | CANH is shorted to GND |
| | | | 0101 | CANL is shorted to GND |
| | | | 0100 | CANH is shorted to V_{CC} , V_{BAT14} or V_{BAT42} |
| | | | 0011 | reserved |
| | | | 0010 | reserved |
| | | | 0001 | reserved |
| | | | 0000 | no failure |
| 6 and 5 | - | reserved | 00 | reserved for SBCs with LIN transceiver |
| 4 | V3D | V3 Diagnosis | 1 | OK |
| | | | 0 | fail; V3 is disabled due to an overload situation |
| 3 | V2D | V2 Diagnosis | 1 | OK ^[1] |
| | | | 0 | fail; V2 is disabled due to an overload situation |
| 2 | V1D | V1 Diagnosis | 1 | OK; V1 always above $V_{UV(VFI)}$ since last read access |
| | | | 0 | fail; V1 was below $V_{UV(VFI)}$ since last read access; bit is set again with read access |

Table 8. System Diagnosis register bit description ...continued

| Bit | Symbol | Description | Value | Function |
|---------|-------------|--------------------|-------|--|
| 1 and 0 | CANMD [1:0] | CAN Mode Diagnosis | 11 | CAN is in Active mode |
| | | | 10 | CAN is in On-line mode |
| | | | 01 | CAN is in On-line Listen mode |
| | | | 00 | CAN is in Off-line mode, or V2 is not active |

[1] V2D will be set when V2 is reactivated after a failure. See [Section 6.6.3.2](#).

6.12.6 Interrupt Enable register and Interrupt Enable Feedback register

These registers allow the SBC interrupt enable bits to be set, cleared and read back.

Table 9. Interrupt Enable and Interrupt Enable Feedback register bit description

| Bit | Symbol | Description | Value | Function |
|-----------|--------|---|-------|---|
| 15 and 14 | A1, A0 | register address | 01 | select the Interrupt Enable register |
| 13 | RRS | Read Register Select | 1 | read the Interrupt register |
| | | | 0 | read the Interrupt Enable Feedback register |
| 12 | RO | Read Only | 1 | read the register selected by RRS without writing to Interrupt Enable register |
| | | | 0 | read the register selected by RRS and write to Interrupt Enable register |
| 11 | WTIE | Watchdog Time-out Interrupt Enable ^[1] | 1 | a watchdog overflow during Standby mode causes an interrupt instead of a reset event (interrupt based cyclic wake-up feature) |
| | | | 0 | no interrupt forced on watchdog overflow; a reset is forced instead |
| 10 | OTIE | OverTemperature Interrupt Enable | 1 | exceeding or dropping below the temperature warning limit causes an interrupt |
| | | | 0 | no interrupt forced |
| 9 | GSIE | Ground Shift Interrupt Enable | 1 | exceeding or dropping below the GND shift limit causes an interrupt |
| | | | 0 | no interrupt forced |
| 8 | SPIFIE | SPI clock count Failure Interrupt Enable | 1 | wrong number of CLK cycles (more than, or less than 16) forces an interrupt; from Start-up mode and Restart mode a reset is performed instead of an interrupt |
| | | | 0 | no interrupt forced; SPI access is ignored if the number of cycles does not equal 16 |
| 7 | BATFIE | BAT Failure Interrupt Enable | 1 | falling edge at SENSE forces an interrupt |
| | | | 0 | no interrupt forced |
| 6 | VFIE | Voltage Failure Interrupt Enable | 1 | clearing of V1D, V2D or V3D forces an interrupt |
| | | | 0 | no interrupt forced |
| 5 | CANFIE | CAN Failure Interrupt Enable | 1 | any change of the CAN Failure status bits forces an interrupt |
| | | | 0 | no interrupt forced |
| 4 | - | reserved | 0 | reserved for SBCs with LIN transceiver |

Table 9. Interrupt Enable and Interrupt Enable Feedback register bit description ...continued

| Bit | Symbol | Description | Value | Function |
|-----|--------|--------------------------------------|-------|---|
| 3 | WIE | WAKE Interrupt Enable ^[2] | 1 | a negative edge at pin WAKE generates an interrupt in Normal mode, Flash mode or Standby mode |
| | | | 0 | a negative edge at pin WAKE generates a reset in Standby mode; no interrupt in any other mode |
| 2 | WDRIE | Watchdog Restart Interrupt Enable | 1 | a watchdog restart during watchdog OFF generates an interrupt |
| | | | 0 | no interrupt forced |
| 1 | CANIE | CAN Interrupt Enable | 1 | CAN-bus event results in a wake-up interrupt in Standby mode and in Normal or Flash mode (unless CAN is in Active mode already) |
| | | | 0 | CAN-bus event results in a reset in Standby mode; no interrupt in any other mode |
| 0 | - | reserved | 0 | reserved for SBCs with LIN transceiver |

[1] This bit is cleared automatically upon each overflow event. It has to be set in software each time the interrupt behavior is required (fail-safe behavior).

[2] WEN (in the System Configuration register) has to be set to activate the WAKE port function globally.

6.12.7 Interrupt register

The Interrupt register allows the cause of an interrupt event to be determined. The register is cleared upon a read access and upon any reset event. Hardware ensures that no interrupt event is lost in case there is a new interrupt forced while reading the register. After reading the Interrupt register, pin INTN is released for t_{INTN} to guarantee an edge event at pin INTN.

The interrupts can be classified into two groups:

- Timing critical interrupts which require immediate reaction (SPI clock count failure which needs a new SPI command to be resent immediately, and a BAT failure which needs critical data to be saved immediately into the nonvolatile memory)
- Interrupts that do not require an immediate reaction (overtemperature, Ground Shift and CAN failures, V1, V2 and V3 failures and the wake-ups via CAN and WAKE). These interrupts will be signalled to the microcontroller once per watchdog period (maximum) in Normal mode; this avoids overloading the microcontroller with unexpected interrupt events (e.g. a chattering CAN failure). However, these interrupts are reflected in the interrupt register

Table 10. Interrupt register bit description

| Bit | Symbol | Description | Value | Function |
|-----------|--------|-----------------------------------|-------|--|
| 15 and 14 | A1, A0 | register address | 01 | read Interrupt register |
| 13 | RRS | Read Register Select | 1 | |
| 12 | RO | Read Only | 1 | read the Interrupt register without writing to the Interrupt Enable register |
| | | | 0 | read the Interrupt register and write to the Interrupt Enable register |
| 11 | WTI | Watchdog Time-out Interrupt | 1 | a watchdog overflow during Standby mode has caused an interrupt (interrupt-based cyclic wake-up feature) |
| | | | 0 | no interrupt |
| 10 | OTI | OverTemperature Interrupt | 1 | the temperature warning status (TWS) has changed |
| | | | 0 | no interrupt |
| 9 | GSI | Ground Shift Interrupt | 1 | the ground shift diagnosis bit (GSD) has changed |
| | | | 0 | no interrupt |
| 8 | SPIFI | SPI clock count Failure Interrupt | 1 | wrong number of CLK cycles (more than, or less than 16) during SPI access |
| | | | 0 | no interrupt; SPI access is ignored if the number of CLK cycles does not equal 16 |
| 7 | BATFI | BAT Failure Interrupt | 1 | falling edge at pin SENSE has forced an interrupt |
| | | | 0 | no interrupt |
| 6 | VFI | Voltage Failure Interrupt | 1 | V1D, V2D or V3D has been cleared |
| | | | 0 | no interrupt |
| 5 | CANFI | CAN Failure Interrupt | 1 | CAN failure status has changed |
| | | | 0 | no interrupt |
| 4 | - | reserved | 0 | reserved for SBCs with LIN transceiver |
| 3 | WI | Wake-up Interrupt | 1 | a negative edge at pin WAKE has been detected |
| | | | 0 | no interrupt |
| 2 | WDR1 | Watchdog Restart Interrupt | 1 | A watchdog restart during watchdog OFF has caused an interrupt |
| | | | 0 | no interrupt |
| 1 | CANI | CAN Wake-up Interrupt | 1 | CAN wake-up event has caused an interrupt |
| | | | 0 | no interrupt |
| 0 | - | reserved | 0 | reserved for SBCs with LIN transceiver |

6.12.8 System Configuration register and System Configuration Feedback register

These registers are used to configure the behavior of the SBC. The settings can be read back.

Table 11. System Configuration and System Configuration Feedback register bit description

| Bit | Symbol | Description | Value | Function |
|-----------|----------|-----------------------------|------------------|---|
| 15 and 14 | A1, A0 | register address | 10 | select System Configuration register |
| 13 | RRS | Read Register Select | 1 | read the General Purpose Feedback register 0 |
| | | | 0 | read the System Configuration Feedback register |
| 12 | RO | Read Only | 1 | read register selected by RRS without writing to System Configuration register |
| | | | 0 | read register selected by RRS and write to System Configuration register |
| 11 and 10 | - | reserved | 0 | reserved for future use; should remain cleared to ensure compatibility with future functions which might use this bit |
| 9 | GSTHC | GND Shift Threshold Control | 1 | $V_{th(GSD)(cm)}$ widened threshold |
| | | | 0 | $V_{th(GSD)(cm)}$ normal threshold |
| 8 | RLC | Reset Length Control | 1 ^[1] | t_{RSTNL} long reset lengthening time selected |
| | | | 0 | t_{RSTNL} short reset lengthening time selected |
| 7 and 6 | V3C[1:0] | V3 Control | 11 | Cyclic mode 2; $t_{w(CS)}$ long period; see Figure 11 |
| | | | 10 | Cyclic mode 1; $t_{w(CS)}$ short period; see Figure 11 |
| | | | 01 | continuously ON |
| | | | 00 | OFF |
| 5 | - | reserved | 0 | reserved for future use; should remain cleared to ensure compatibility with future functions which might use this bit |
| 4 | V1CMC | V1 Current Monitor Control | 1 | an increasing V1 current causes a reset if the watchdog was disabled during Standby mode |
| | | | 0 | an increasing V1 current just reactivates the watchdog during Standby mode |
| 3 | WEN | Wake Enable ^[2] | 1 | WAKE pin enabled |
| | | | 0 | WAKE pin disabled |
| 2 | WSC | Wake Sample Control | 1 | Wake mode cyclic sample |
| | | | 0 | Wake mode continuous sample |
| 1 | ILEN | INH/LIMP Enable | 1 | INH/LIMP pin active (See ILC bit) |
| | | | 0 | INH/LIMP pin floating |
| 0 | ILC | INH/LIMP Control | 1 | INH/LIMP pin HIGH if ILEN bit is set |
| | | | 0 | INH/LIMP pin LOW if ILEN bit is set |

[1] RLC is set automatically with entering Restart mode or Fail-safe mode. This guarantees a safe reset period in case of serious failure situations. External reset spikes are lengthened by the SBC until the programmed reset length is reached.

[2] If WEN is not set, the WAKE port is completely disabled. There is no change of the bits EWS and WLS within the System Status register.

6.12.9 Physical Layer Control register and Physical Layer Control Feedback register

These registers are used to configure the CAN transceiver. The settings can be read back.

Table 12. Physical Layer Control and Physical Layer Control Feedback register bit description

| Bit | Symbol | Description | Value | Function |
|-----------|--------|--|-------|---|
| 15 and 14 | A1, A0 | register address | 11 | select Physical Layer Control register |
| 13 | RRS | Read Register Select | 1 | read the General Purpose Feedback register 1 |
| | | | 0 | read the Physical Layer Control Feedback register |
| 12 | RO | Read Only | 1 | read the register selected by RRS without writing to the Physical Layer Control register |
| | | | 0 | read the register selected by RRS and write to Physical Layer Control register |
| 11 | V2C | V2 Control | 1 | V2 remains active in CAN Off-line mode |
| | | | 0 | V2 is OFF in CAN Off-line mode |
| 10 | CPNC | CAN Partial Networking Control | 1 | CAN transceiver enters On-line Listen mode instead of On-line mode; cleared whenever the SBC enters On-line mode or Active mode |
| | | | 0 | On-line Listen mode disabled |
| 9 | COTC | CAN Off-line Time Control ^[1] | 1 | $t_{\text{off-line}}$ long period (extended to $t_{\text{off-line(EXT)}}$ after wake-up) |
| | | | 0 | $t_{\text{off-line}}$ short period (extended to $t_{\text{off-line(EXT)}}$ after wake-up) |
| 8 | CTC | CAN Transmitter Control ^[2] | 1 | CAN transmitter is disabled |
| | | | 0 | CAN transmitter is enabled |
| 7 | CRC | CAN Receiver Control | 1 | TXD signal is forwarded directly to RXD for self-test purposes (loopback behavior); only if CTC = 1 |
| | | | 0 | TXD signal is not forwarded to RXD (normal behavior) |
| 6 | CMC | CAN Mode Control | 1 | CAN Active mode (in Normal mode and Flash mode only) |
| | | | 0 | CAN Active mode disabled |
| 5 | CSC | CAN Split Control | 1 | CAN SPLIT pin active |
| | | | 0 | CAN SPLIT pin floating |
| 4 to 2 | - | reserved | 000 | reserved for SBCs with LIN transceiver |
| 1 | - | reserved ^[3] | 0 | reserved for SBCs with LIN transceiver |
| 0 | - | reserved ^[4] | 1 | reserved for SBCs with LIN transceiver |

[1] For the CAN transceiver to enter Off-Line mode from On-line or On-line Listen mode a minimum time without bus activity is needed. This minimum time $t_{\text{off-line}}$ is defined by COTC; see [Section 6.7.1.4](#).

[2] In case of an RXDC / TXDC interfacing failure the CAN transmitter is disabled without setting CTC. Recovery from such a failure is automatic when CAN communication (with correct interfacing levels) is received. Manual recovery is also possible by setting and clearing the CTC bit under software control.

[3] Default value is 1; therefore this bit should be set to 0 by the application.

[4] Default value is 0; therefore this bit should be set to 1 by the application.

6.12.10 Special Mode register and Special Mode Feedback register

These registers are used to configure global SBC parameters during system start-up. The settings can be read back.

Table 13. Special Mode register and Special Mode Feedback register bit description

| Bit | Symbol | Description | Value | Function |
|-----------|--------------|---|-------|---|
| 15 and 14 | A1, A0 | register address | 01 | select Special Mode register |
| 13 | RRS | Read Register Select | 0 | read the Interrupt Enable Feedback register |
| | | | 1 | read the Special Mode Feedback register |
| 12 | RO | Read Only | 1 | read the register selected by RRS without writing to the Special Mode register |
| | | | 0 | read the register selected by RRS and write to the Special Mode register |
| 11 and 10 | - | reserved | 0 | reserved for future use; should remain cleared to ensure compatibility with future functions which might use this bit |
| 9 | ISDM | Initialize Software Development Mode ^[1] | 1 | initialization of software development mode |
| | | | 0 | normal watchdog interrupt, reset monitoring and fail-safe behavior |
| 8 | ERREM | Error-pin Emulation Mode | 1 | pin EN reflects the status of the CANFD bits: EN is set if CANFD = 0000 (no error) EN is cleared if CANFD is not 0000 (error) |
| | | | 0 | pin EN behaves as an enable pin; see Section 6.5.2 |
| 7 | - | reserved | 0 | reserved for future use; should remain cleared to ensure compatibility with future functions which might use this bit |
| 6 and 5 | WDPRE [1:0] | Watchdog prescaler | 00 | watchdog prescale factor 1 |
| | | | 01 | watchdog prescale factor 1.5 |
| | | | 10 | watchdog prescale factor 2.5 |
| | | | 11 | watchdog prescale factor 3.5 |
| 4 and 3 | V1RTHC [1:0] | V1 Reset Threshold Control | 11 | $V1 \text{ reset threshold} = 0.9 \times V_{V1(nom)}$ |
| | | | 10 | $V1 \text{ reset threshold} = 0.7 \times V_{V1(nom)}$ ^[2] |
| | | | 01 | $V1 \text{ reset threshold} = 0.8 \times V_{V1(nom)}$ |
| | | | 00 | $V1 \text{ reset threshold} = 0.9 \times V_{V1(nom)}$ |
| 2 to 0 | - | reserved | 0 | reserved for future use; should remain cleared to ensure compatibility with future functions which might use this bit |

[1] See [Section 6.13.1](#).

[2] Not supported for the UJA1066TW/3V3 version.

6.12.11 General Purpose registers and General Purpose Feedback registers

The UJA1066 contains two 12-bit General Purpose registers (and accompanying General Purpose Feedback registers) without predefined bit definitions. These registers can be used by the microcontroller for advanced system diagnosis or for storing critical system status information outside the microcontroller. After Power-up, General Purpose register 0 will contain a 'Device Identification Code' consisting of the SBC type and SBC version. This code is available until it is overwritten by the microcontroller (as indicated by the DIC bit).

Table 14. General Purpose register 0 and General Purpose Feedback register 0 bit description

| Bit | Symbol | Description | Value | Function |
|---------|-----------|--|-------|---|
| 15, 14 | A1, A0 | register address | 10 | read the General Purpose Feedback register 0 |
| 13 | RRS | read register select | 1 | read the General Purpose Feedback register 0 |
| | | | 0 | read the System Configuration Feedback register |
| 12 | RO | read only | 1 | read the register selected by RRS without writing to the General Purpose register 0 |
| | | | 0 | read the register selected by RRS and write to the General Purpose register 0 |
| 11 | DIC | device identification control ^[1] | 1 | General Purpose register 0 contains user-defined bits |
| | | | 0 | General Purpose register 0 contains the Device Identification Code |
| 10 to 0 | GP0[10:0] | general purpose bits ^[2] | 1 | user-defined |
| | | | 0 | user-defined |

[1] The Device Identification Control bit is cleared during power-up of the SBC, indicating that General Purpose register 0 is loaded with the Device Identification Code. Any write access to General Purpose register 0 will set the DIC bit, regardless of the value written to DIC.

[2] During power-up the General Purpose register 0 is loaded with a 'Device Identification Code' consisting of the SBC type and SBC version, and the DIC bit is cleared.

Table 15. General Purpose register 1 and General Purpose Feedback register 1 bit description

| Bit | Symbol | Description | Value | Function |
|-----------|-----------|----------------------|-------|---|
| 15 and 14 | A1, A0 | register address | 11 | select General Purpose register 1 |
| 13 | RRS | read register select | 1 | read the General Purpose Feedback register 1 |
| | | | 0 | read the Physical Layer Control Feedback register |
| 12 | RO | read only | 1 | read the register selected by RRS without writing to the General Purpose register 1 |
| | | | 0 | read the register selected by RRS and write to the General Purpose register |
| 11 to 0 | GP1[11:0] | general purpose bits | 1 | user-defined |
| | | | 0 | user-defined |

6.12.12 Register configurations at reset

At Power-on, Start-up and Restart mode the setting of the SBC registers is predefined.

Table 16. System Status register: status at reset

| Symbol | Name | Power-on | Start-up [1] | Restart [1] |
|--------|----------------------------------|-----------------------|---|---|
| RSS | reset source status | 0000 (power-on reset) | any value except 1100 | 0000 or 0010 or 1100 or 1110 |
| CWS | CAN wake-up status | 0 (no CAN wake-up) | 1 if reset is caused by a CAN wake-up, otherwise no change | no change |
| EWS | edge wake-up status | 0 (no edge detected) | 1 if reset is caused by a wake-up via pin WAKE, otherwise no change | no change |
| WLS | WAKE level status | actual status | actual status | actual status |
| TWS | temperature warning status | 0 (no warning) | actual status | actual status |
| SDMS | software development mode status | actual status | actual status | actual status |
| ENS | enable status | 0 (EN = LOW) | 0 if ERREM = 0, otherwise actual CAN failure status | 0 if ERREM = 0, otherwise actual CAN failure status |
| PWONS | power-on status | 1 (power-on reset) | no change | no change |

[1] Depends on history.

Table 17. System Diagnosis register: status at reset

| Symbol | Name | Power-on | Start-up | Restart |
|--------|------------------------|-------------------|---------------|---------------|
| GSD | ground shift diagnosis | 0 (OK) | actual status | actual status |
| CANFD | CAN failure diagnosis | 0000 (no failure) | actual status | actual status |
| V3D | V3 diagnosis | 1 (OK) | actual status | actual status |
| V2D | V2 diagnosis | 1 (OK) | actual status | actual status |
| V1D | V1 diagnosis | 0 (fail) | actual status | actual status |
| CANMD | CAN mode diagnosis | 00 (Off-line) | actual status | actual status |

Table 18. Interrupt Enable register and Interrupt Enable Feedback register: status at reset

| Symbol | Name | Power-on | Start-up | Restart |
|--------|----------|------------------------|-----------|-----------|
| All | all bits | 0 (interrupt disabled) | no change | no change |

Table 19. Interrupt register: status at reset

| Symbol | Name | Power-on | Start-up | Restart |
|--------|----------|------------------|------------------|------------------|
| All | all bits | 0 (no interrupt) | 0 (no interrupt) | 0 (no interrupt) |

Table 20. System Configuration register and System Configuration Feedback register: status at reset

| Symbol | Name | Power-on | Start-up | Restart | Fail-Safe |
|--------|-----------------------------------|----------------------|---|--|------------|
| GSTHC | GND shift level threshold control | 0 (normal) | no change | no change | no change |
| RLC | reset length control | 0 (short) | no change | 1 (long) | 1 (long) |
| V3C | V3 control | 00 (off) | no change | no change | no change |
| V1CMC | V1 current monitor control | 0 (watchdog restart) | no change | no change | no change |
| WEN | wake enable | 1 (enabled) | no change | no change | no change |
| WSC | wake sample control | 0 (control) | no change | no change | no change |
| ILEN | INH/LIMP enable | 0 (floating) | see Figure 10 if ILC = 1, otherwise no change | 0 (floating) if ILC = 1, otherwise no change | 1 (active) |
| ILC | INH/LIMP control | 0 (LOW) | no change | no change | 0 (LOW) |

Table 21. Physical Layer Control register and Physical Layer Control Feedback register: status at reset

| Symbol | Name | Power-on | Start-up | Restart | Fail-Safe |
|--------|--------------------------------|----------------------------------|--|-----------|----------------------------------|
| V2C | V2 control | 0 (auto) | no change | no change | 0 (auto) |
| CPNC | CAN partial networking control | 0 (on-line Listen mode disabled) | 0 if reset is caused by a CAN wake-up, otherwise no change | no change | 0 (On-line Listen mode disabled) |
| COTC | CAN off-line time control | 1 (long) | no change | no change | no change |
| CTC | CAN transmitter control | 0 (on) | no change | no change | no change |
| CRC | CAN receiver control | 0 (normal) | no change | no change | no change |
| CMC | CAN mode control | 0 (Active mode disabled) | no change | no change | no change |
| CSC | CAN split control | 0 (off) | no change | no change | no change |

Table 22. Special Mode register: status at reset

| Symbol | Name | Power-on | Start-up | Restart |
|--------|--------------------------------------|-----------------|-----------|-----------|
| ISDM | initialize software development mode | 0 (no) | no change | no change |
| ERREM | error pin emulation mode | 0 (EN function) | no change | no change |
| WDPRE | watchdog prescale factor | 00 (factor 1) | no change | no change |
| V1RTHC | V1 reset threshold control | 00 (90 %) | no change | 00 (90 %) |

Table 23. General Purpose register 0 and General Purpose Feedback register 0: status at reset

| Symbol | Name | Power-on | Start-up | Restart |
|-----------|--|--------------------|-----------|-----------|
| DIC | device identification control | 0 (device ID) | no change | no change |
| GP0[10:7] | general purpose bits 10 to 7 (version) | mask version | no change | no change |
| GP0[6:0] | general purpose bits 6 to 0 (SBC type) | 000 0110 (UJA1066) | no change | no change |

Table 24. General Purpose register 1 and General Purpose Feedback register 1: status at reset

| Symbol | Name | Power-on | Start-up | Restart |
|-----------|------------------------------|----------------|-----------|-----------|
| GP1[11:0] | general purpose bits 11 to 0 | 0000 0000 0000 | no change | no change |

6.13 Test modes

6.13.1 Software development mode

The Software development mode is intended to support software developers in writing and pretesting application software without having to work around watchdog triggering and without unwanted jumps to Fail-safe mode.

In Software development mode, the following events do not force a system reset:

- Watchdog overflow in Normal mode
- Watchdog window miss
- Interrupt time-out
- Elapsed start-up time

However, in the case of a watchdog trigger failure the reset source information is still written to the System Status register, as if a real reset event had occurred.

The exclusion of watchdog related resets allows for simplified software testing because problems with watchdog triggering can be indicated by interrupts instead of resets. The SDM bit does not affect the watchdog behavior in Standby and Sleep modes. This allows the cyclic wake-up behavior to be evaluated in these modes.

All transitions to Fail-safe mode are disabled. This makes it possible to work with an external emulator that clamps the reset line LOW in debugging mode. A V1 undervoltage of more than $t_{V1(CL T)}$ is the only exception that results in a transition to Fail-safe mode (to protect the SBC). Transitions from Start-up mode to Restart mode are still possible.

There are two ways to enter Software development mode. One is by setting the ISDM bit in the Special Mode register ([Table 13](#)); possible only after the initial connection of a battery while the SBC is in Start-up mode. The other is by applying the correct $V_{th(TE ST)}$ input voltage at pin TEST before the battery has been connected to pin BAT42.

To remain in Software development mode the SDM bit in the Mode register must be set each time the Mode register is accessed (i.e. watchdog triggering) regardless of how Software development mode was entered.

Software development mode can be exited at any time by clearing the SDM bit in the Mode register. Reentering the Software development mode is only possible by reconnecting the battery supply (pin BAT42), thereby forcing a new power-on reset.

6.13.2 Forced normal mode

The UJA1066 provides Forced normal mode for system evaluation purposes. This mode is strictly for evaluation purposes only. In this mode the characteristics as defined in [Section 9](#) and [Section 10](#) cannot be guaranteed.

In Forced normal mode the SBC behaves as follows:

- SPI access (writing and reading) is blocked
- Watchdog disabled
- Interrupt monitoring disabled
- Reset monitoring disabled
- Reset lengthening disabled
- All transitions to Fail-safe mode are disabled, except a V1 undervoltage for more than $t_{V1(CL)}$
- V1 is started with the long reset time t_{RSTNL} . In the case of a V1 undervoltage, a reset is performed until V1 is restored (normal behavior), and the SBC stays in Forced normal mode; if an overload occurs at V1 lasting longer than $t_{V1(CL)}$, Fail-safe mode is entered
- V2 is on; overload protection active
- V3 is on; overload protection active
- CAN is in Active mode and cannot switch to Off-line mode
- INH/LIMP pin is HIGH
- SYSINH is HIGH
- EN pin at same level as RSTN pin

Forced normal mode is activated by applying the correct $V_{th(TEST)}$ input voltage at the TEST pin during initial battery connection.

7. Limiting values

Table 25. Limiting values

In accordance with the Absolute Maximum Rating System (IEC 60134). All voltages are referenced to GND.

| Symbol | Parameter | Conditions | Min | Max | Unit |
|-------------|----------------------|----------------------------------|------|-----|------|
| V_{BAT42} | BAT42 supply voltage | | -0.3 | +60 | V |
| | | load dump; $t \leq 500$ ms | - | +60 | V |
| V_{BAT14} | BAT14 supply voltage | $V_{BAT42} \geq V_{BAT14} - 1$ V | | | |
| | | continuous | -0.3 | +33 | V |
| | | load dump; $t \leq 500$ ms | - | +45 | V |

Table 25. Limiting values ...continued

In accordance with the Absolute Maximum Rating System (IEC 60134). All voltages are referenced to GND.

| Symbol | Parameter | Conditions | Min | Max | Unit |
|--------------------|--|--|----------|--------------------------|------|
| V _{DC(n)} | DC voltage on pins | | | | |
| | V1 and V2 | | -0.3 | +5.5 | V |
| | V3 and SYSINH | | -1.5 | V _{BAT42} + 0.3 | V |
| | INH/LIMP | | -0.3 | V _{BAT42} + 0.3 | V |
| | SENSE | | -0.3 | V _{BAT42} + 1.2 | V |
| | WAKE | | -1.5 | +60 | V |
| | CANH, CANL and SPLIT | with respect to any other pin | -60 | +60 | V |
| | TXDC, RXDC, SDO, SDI, SCK, SCS, RSTN, INTN and EN | | -0.3 | V _{V1} + 0.3 | V |
| | TEST | | -0.3 | +15 | V |
| V _{trt} | transient voltage | at pins CANH and CANL; in accordance with ISO 7637-3 | -150 | +100 | V |
| I _{WAKE} | DC current at pin WAKE | | [1] -15 | - | mA |
| T _{stg} | storage temperature | | -55 | +150 | °C |
| T _{amb} | ambient temperature | | -40 | +125 | °C |
| T _{vj} | virtual junction temperature | | [2] -40 | +150 | °C |
| V _{esd} | electrostatic discharge voltage | HBM | [3] | | |
| | | at pins CANH, CANL, SPLIT, WAKE, BAT42, V3, SENSE; with respect to GND | [4] -8.0 | +8.0 | kV |
| | | at any other pin | -2.0 | +2.0 | kV |
| | | MM; at any pin | [5] -200 | +200 | V |

[1] Only relevant if V_{WAKE} < V_{GND} - 0.3 V; current will flow into pin GND.

[2] In accordance with IEC 60747-1. An alternative definition of virtual junction temperature is: $T_{vj} = T_{amb} + P_d \times R_{th(vj-amb)}$, where $R_{th(vj-amb)}$ is a fixed value to be used for the calculation of T_{vj} . The rating for T_{vj} limits the allowable combinations of power dissipation (P_d) and ambient temperature (T_{amb}).

[3] Human Body Model (HBM): C = 100 pF; R = 1.5 kΩ.

[4] ESD performance according to IEC 61000-4-2 (C = 150 pF, R = 330 Ω) of pins CANH, CANL, SPLIT, WAKE, BAT42 and V3 with respect to GND was verified by an external test house. Following results were obtained:

a) Equal or better than ±4 kV (unaided)

b) Equal or better than ±20 kV (using external ESD protection: NXP Semiconductors PESD1CAN diode)

[5] Machine Model (MM): C = 200 pF; L = 0.75 μH; R = 10 Ω.

8. Thermal characteristics

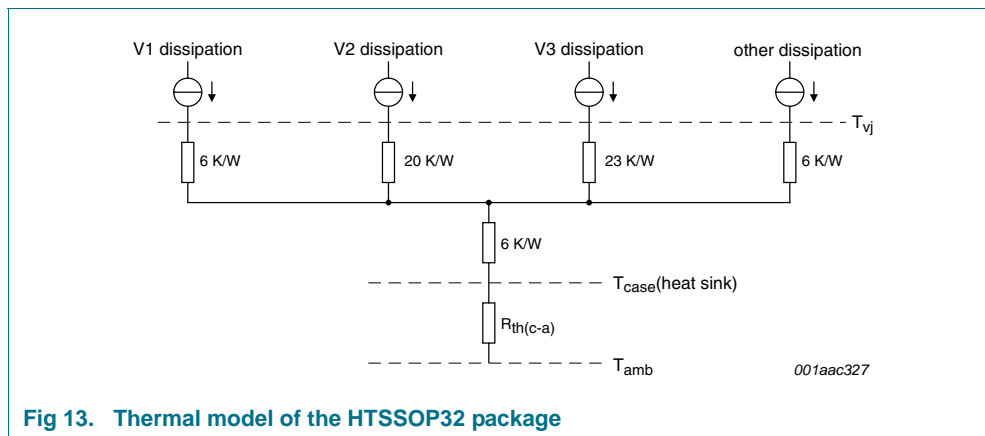

Fig 13. Thermal model of the HTSSOP32 package

9. Static characteristics

Table 26. Static characteristics

$T_{vj} = -40\text{ }^{\circ}\text{C}$ to $+150\text{ }^{\circ}\text{C}$; $V_{BAT42} = 5.5\text{ V}$ to 52 V ; $V_{BAT14} = 5.5\text{ V}$ to 27 V ; $V_{BAT42} \geq V_{BAT14} - 1\text{ V}$; unless otherwise specified. All voltages are defined with respect to ground. Positive currents flow into the IC.[\[1\]](#)

| Symbol | Parameter | Conditions | Min | Typ | Max | Unit |
|--------------------------|--|--|------|-----|------|---------------|
| Supply; pin BAT42 | | | | | | |
| I_{BAT42} | BAT42 supply current | V1, V2 and V3 off; CAN in Off-line mode; OTIE = BATFIE = 0; $I_{SYSINH} = I_{WAKE} = 0\text{ A}$ | | | | |
| | | $V_{BAT42} = 8.1\text{ V}$ to 52 V | - | 50 | 70 | μA |
| | | $V_{BAT42} = 5.5\text{ V}$ to 8.1 V | - | 70 | 93 | μA |
| $I_{BAT42(add)}$ | additional BAT42 supply current | V1 and/or V2 on; $I_{SYSINH} = 0\text{ mA}$ | - | 53 | 76 | μA |
| | | V3 in Cyclic mode; $I_{V3} = 0\text{ mA}$ | - | 0 | 1 | μA |
| | | V3 continuously on; $I_{V3} = 0\text{ mA}$ | - | 30 | 50 | μA |
| | | T_{vj} warning enabled; OTIE = 1 | - | 20 | 40 | μA |
| | | SENSE enabled; BATFIE = 1 | - | 2 | 7 | μA |
| | | CAN in Active mode; CMC = 1 | - | 750 | 1500 | μA |
| | | $V_{BAT42} = 12\text{ V}$ | - | 1.5 | 5 | mA |
| | | $V_{BAT42} = 27\text{ V}$ | - | 3 | 10 | mA |
| $V_{POR(BAT42)}$ | BAT42 voltage level for power-on reset status bit change | for setting PWONS | | | | |
| | | PWONS = 0; V_{BAT42} falling | 4.45 | - | 5 | V |
| | | for clearing PWONS | | | | |
| | PWONS = 1; V_{BAT42} rising | 4.75 | - | 5.5 | V | |

Table 26. Static characteristics ...continued

$T_{vj} = -40\text{ °C to }+150\text{ °C}$, $V_{BAT42} = 5.5\text{ V to }52\text{ V}$; $V_{BAT14} = 5.5\text{ V to }27\text{ V}$; $V_{BAT42} \geq V_{BAT14} - 1\text{ V}$; unless otherwise specified. All voltages are defined with respect to ground. Positive currents flow into the IC.[\[1\]](#)

| Symbol | Parameter | Conditions | Min | Typ | Max | Unit |
|---|-------------------------------------|--|-----------------------|---------------|-----------------------|---------------|
| Supply; pin BAT14 | | | | | | |
| I_{BAT14} | BAT14 supply current | V1 and V2 off; CAN in Off-line mode; ILEN = CSC = 0; $I_{INH/LIMP} = I_{SPLIT} = 0\text{ mA}$ | - | 2 | 5 | μA |
| $I_{BAT14(add)}$ | additional BAT14 supply current | V1 on; $I_{V1} = 0\text{ mA}$ | - | 200 | 300 | μA |
| | | V1 on; $I_{V1} = 0\text{ mA}$; $V_{BAT14} = 12\text{ V}$ | - | 150 | 200 | μA |
| | | V2 on; $I_{V2} = 0\text{ mA}$ | - | 200 | 320 | μA |
| | | V2 on; $I_{V2} = 0\text{ mA}$; $V_{BAT14} = 12\text{ V}$ | - | 200 | 250 | μA |
| | | INH/LIMP enabled; ILEN = 1; $I_{INH/LIMP} = 0\text{ mA}$ | - | 1 | 2 | μA |
| | | CAN in Active mode; CMC = 1; $I_{CANH} = I_{CANL} = 0\text{ mA}$ | - | 5 | 10 | mA |
| | | SPLIT active; CSC = 1; $I_{SPLIT} = 0\text{ mA}$ | - | 1 | 2 | mA |
| V_{BAT14} | BAT14 voltage level | for normal output current capability at V1 | 9 | - | 27 | V |
| | | for high output current capability at V1 | 6 | - | 8 | V |
| Battery supply monitor input; pin SENSE | | | | | | |
| $V_{th(SENSE)}$ | input threshold low battery voltage | detection | 1 | 2.5 | 3 | V |
| | | release | 1.7 | - | 4 | V |
| $I_{IH(SENSE)}$ | HIGH-level input current | Normal mode; BATFIE = 1 | 20 | 50 | 100 | μA |
| | | Standby mode; BATFIE = 1 | 5 | 10 | 20 | μA |
| | | Normal mode or Standby mode; BATFIE = 0 | - | 0.2 | 2 | μA |
| Voltage source; pin V1[2]; see also Figure 14 to Figure 20 | | | | | | |
| $V_{o(V1)}$ | output voltage | $V_{BAT14} = 5.5\text{ V to }18\text{ V}$; $I_{V1} = -120\text{ mA to }-5\text{ mA}$; $T_j = 25\text{ °C}$ | $V_{V1(nom)} - 0.1$ | $V_{V1(nom)}$ | $V_{V1(nom)} + 0.1$ | V |
| | | $V_{BAT14} = 14\text{ V}$; $I_{V1} = -5\text{ mA}$; $T_j = 25\text{ °C}$ | $V_{V1(nom)} - 0.025$ | $V_{V1(nom)}$ | $V_{V1(nom)} + 0.025$ | V |
| ΔV_{V1} | supply voltage regulation | $V_{BAT14} = 9\text{ V to }16\text{ V}$; $I_{V1} = -5\text{ mA}$; $T_j = 25\text{ °C}$ | - | 1 | 25 | mV |
| | load regulation | $V_{BAT14} = 14\text{ V}$; $I_{V1} = -50\text{ mA to }-5\text{ mA}$; $T_j = 25\text{ °C}$ | - | 5 | 25 | mV |
| | voltage drift with temperature | $V_{BAT14} = 14\text{ V}$; $I_{V1} = -5\text{ mA}$; $T_j = -40\text{ °C to }+150\text{ °C}$ | [3] - | - | 200 | ppm/K |

Table 26. Static characteristics ...continued

$T_{vj} = -40\text{ °C}$ to $+150\text{ °C}$, $V_{BAT42} = 5.5\text{ V}$ to 52 V ; $V_{BAT14} = 5.5\text{ V}$ to 27 V ; $V_{BAT42} \geq V_{BAT14} - 1\text{ V}$; unless otherwise specified. All voltages are defined with respect to ground. Positive currents flow into the IC.[\[1\]](#)

| Symbol | Parameter | Conditions | Min | Typ | Max | Unit |
|---|---|--|---------------------------|---------------------------|---------------------------|----------|
| $V_{det(UV)(V1)}$ | undervoltage detection and reset activation level | $V_{BAT14} = 14\text{ V}$; $V1RTHC[1:0] = 00$ or 11 | $0.90 \times V_{V1(nom)}$ | $0.92 \times V_{V1(nom)}$ | $0.95 \times V_{V1(nom)}$ | V |
| | | $V_{BAT14} = 14\text{ V}$; $V1RTHC[1:0] = 01$ | $0.80 \times V_{V1(nom)}$ | $0.82 \times V_{V1(nom)}$ | $0.85 \times V_{V1(nom)}$ | V |
| | | $V_{BAT14} = 14\text{ V}$; $V1RTHC[1:0] = 10$ | $0.70 \times V_{V1(nom)}$ | $0.72 \times V_{V1(nom)}$ | $0.75 \times V_{V1(nom)}$ | V |
| $V_{rel(UV)(V1)}$ | undervoltage detection release level | $V_{BAT14} = 14\text{ V}$; $V1RTHC[1:0] = 00$ or 11 | - | $0.94 \times V_{V1(nom)}$ | - | V |
| | | $V_{BAT14} = 14\text{ V}$; $V1RTHC[1:0] = 01$ | - | $0.84 \times V_{V1(nom)}$ | - | V |
| | | $V_{BAT14} = 14\text{ V}$; $V1RTHC[1:0] = 10$ | - | $0.74 \times V_{V1(nom)}$ | - | V |
| $V_{UV(VFI)}$ | undervoltage level for generating a VFI interrupt | $V_{BAT14} = 14\text{ V}$; $VFIE = 1$ | $0.90 \times V_{V1(nom)}$ | $0.93 \times V_{V1(nom)}$ | $0.97 \times V_{V1(nom)}$ | V |
| $I_{thH}(V1)$ | undercurrent threshold for watchdog enable | | -10 | -5 | -2 | mA |
| $I_{thL}(V1)$ | undercurrent threshold for watchdog disable | | -6 | -3 | -1.5 | mA |
| I_{V1} | output current capability | $V_{BAT14} = 9\text{ V}$ to 27 V ; $\delta V_{V1} = 0.05 \times V_{V1(nom)}$ | -200 | -135 | -120 | mA |
| | | $V_{BAT14} = 9\text{ V}$ to 27 V ; $V1$ shorted to GND | -200 | -110 | - | mA |
| | | $V_{BAT14} = 5.5\text{ V}$ to 9 V ; $\delta V_{V1} = 0.05 \times V_{V1(nom)}$ | - | - | -120 | mA |
| $Z_{ds(on)}$ | regulator impedance between pins BAT14 and V1 | $V_{BAT14} = 4\text{ V}$ to 5 V | - | 3 | 5 | Ω |
| Voltage source; pin V2 [4] | | | | | | |
| $V_o(V2)$ | output voltage | $V_{BAT14} = 9\text{ V}$ to 16 V ; $I_{V2} = -50\text{ mA}$ to -5 mA | 4.8 | 5.0 | 5.2 | V |
| | | $V_{BAT14} = 14\text{ V}$; $I_{V2} = -10\text{ mA}$; $T_j = 25\text{ °C}$ | 4.95 | 5.0 | 5.05 | V |
| ΔV_{V2} | supply voltage regulation | $V_{BAT14} = 9\text{ V}$ to 16 V ; $I_{V2} = -10\text{ mA}$; $T_j = 25\text{ °C}$ | - | 1 | 25 | mV |
| | load regulation | $V_{BAT14} = 14\text{ V}$; $I_{V2} = -50\text{ mA}$ to -5 mA ; $T_j = 25\text{ °C}$ | - | - | 50 | mV |
| | voltage drift with temperature | $V_{BAT14} = 14\text{ V}$; $I_{V2} = -10\text{ mA}$; $-40\text{ °C} < T_j < +150\text{ °C}$ | [3] - | - | 200 | ppm/K |

Table 26. Static characteristics ...continued

$T_{vj} = -40\text{ °C to }+150\text{ °C}$, $V_{BAT42} = 5.5\text{ V to }52\text{ V}$; $V_{BAT14} = 5.5\text{ V to }27\text{ V}$; $V_{BAT42} \geq V_{BAT14} - 1\text{ V}$; unless otherwise specified. All voltages are defined with respect to ground. Positive currents flow into the IC.[\[1\]](#)

| Symbol | Parameter | Conditions | Min | Typ | Max | Unit |
|--|--|--|---------------------|-----|----------------------|---------------|
| I_{V2} | output current capability | $V_{BAT14} = 9\text{ V to }27\text{ V}$; $\delta V_{V2} = 300\text{ mV}$ | -200 | - | -120 | mA |
| | | $V_{BAT14} = 9\text{ V to }27\text{ V}$; V2 shorted to GND | -300 | - | - | mA |
| | | $V_{BAT14} = 6\text{ V to }8\text{ V}$; $\delta V_{V2} = 300\text{ mV}$ | - | - | -80 | mA |
| | | $V_{BAT14} = 5.5\text{ V}$; $\delta V_{V2} = 300\text{ mV}$ | - | - | -50 | mA |
| $V_{det(UV)(V2)}$ | undervoltage detection threshold | $V_{BAT14} = 14\text{ V}$ | 4.5 | 4.6 | 4.8 | V |
| Voltage source; pin V3 | | | | | | |
| $V_{BAT42-V3(drop)}$ | V_{BAT42} to V_{V3} voltage drop | $V_{BAT42} = 9\text{ V to }52\text{ V}$; $I_{V3} = -20\text{ mA}$ | - | - | 1.0 | V |
| $I_{det(OL)(V3)}$ | overload current detection threshold | $V_{BAT42} = 9\text{ V to }52\text{ V}$ | -165 | - | -60 | mA |
| $ I_L $ | leakage current | $V_{V3} = 0\text{ V}$; $V3C[1:0] = 00$ | - | 0 | 5 | μA |
| System inhibit output; pin SYSINH | | | | | | |
| $V_{BAT42-SYSINH(drop)}$ | V_{BAT42} to V_{SYSINH} voltage drop | $I_{SYSINH} = -0.2\text{ mA}$ | - | 1.0 | 2.0 | V |
| $ I_L $ | leakage current | $V_{SYSINH} = 0\text{ V}$ | - | - | 5 | μA |
| Inhibit/limp-home output; pin INH/LIMP | | | | | | |
| $V_{BAT14-INH(drop)}$ | V_{BAT14} to V_{INH} voltage drop | $I_{INH/LIMP} = -10\text{ }\mu\text{A}$; $I_{LEN} = I_{LC} = 1$ | - | 0.7 | 1.0 | V |
| | | $I_{INH/LIMP} = -200\text{ }\mu\text{A}$; $I_{LEN} = I_{LC} = 1$ | - | 1.2 | 2.0 | V |
| $I_{o(INH/LIMP)}$ | output current capability | $V_{INH/LIMP} = 0.4\text{ V}$; $I_{LEN} = 1$; $I_{LC} = 0$ | 0.8 | - | 4 | mA |
| $ I_L $ | leakage current | $V_{INH/LIMP} = 0\text{ V to }V_{BAT14}$; $I_{LEN} = 0$ | - | - | 5 | μA |
| Wake input; pin WAKE | | | | | | |
| $V_{th(WAKE)}$ | wake-up voltage threshold | | 2.0 | 3.3 | 5.2 | V |
| $I_{WAKE(pu)}$ | pull-up input current | $V_{WAKE} = 0\text{ V}$ | -25 | - | -1.3 | μA |
| Serial peripheral interface inputs; pins SDI, SCK and SCS | | | | | | |
| $V_{IH(th)}$ | HIGH-level input threshold voltage | | $0.7 \times V_{V1}$ | - | $V_{V1} + 0.3$ | V |
| $V_{IL(th)}$ | LOW-level input threshold voltage | | -0.3 | - | $+0.3 \times V_{V1}$ | V |
| $R_{pd(SCK)}$ | pull-down resistor at pin SCK | $V_{SCK} = 2\text{ V}$; $V_{V1} \geq 2\text{ V}$ | 50 | 130 | 400 | k Ω |
| $R_{pu(SCS)}$ | pull-up resistor at pin SCS | $V_{SCS} = 1\text{ V}$; $V_{V1} \geq 2\text{ V}$ | 50 | 130 | 400 | k Ω |
| I_{SDI} | input leakage current at pin SDI | $V_{SDI} = 0\text{ V to }V_{V1}$ | -5 | - | +5 | μA |

Table 26. Static characteristics ...continued

$T_{vj} = -40\text{ }^{\circ}\text{C}$ to $+150\text{ }^{\circ}\text{C}$, $V_{BAT42} = 5.5\text{ V}$ to 52 V ; $V_{BAT14} = 5.5\text{ V}$ to 27 V ; $V_{BAT42} \geq V_{BAT14} - 1\text{ V}$; unless otherwise specified. All voltages are defined with respect to ground. Positive currents flow into the IC.[\[1\]](#)

| Symbol | Parameter | Conditions | Min | Typ | Max | Unit |
|---|------------------------------------|---|---------------------|-----|----------------------|------------------|
| Serial peripheral interface data output; pin SDO | | | | | | |
| I_{OH} | HIGH-level output current | $V_{SCS} = 0\text{ V}$; $V_O = V_{V1} - 0.4\text{ V}$ | -50 | - | -1.6 | mA |
| I_{OL} | LOW-level output current | $V_{SCS} = 0\text{ V}$; $V_O = 0.4\text{ V}$ | 1.6 | - | 20 | mA |
| $I_{OL(off)}$ | OFF-state output leakage current | $V_{SCS} = V_{V1}$; $V_O = 0\text{ V}$ to V_{V1} | -5 | - | +5 | μA |
| Reset output with clamping detection; pin RSTN | | | | | | |
| I_{OH} | HIGH-level output current | $V_{RSTN} = 0.7 \times V_{V1(nom)}$ | -1000 | - | -50 | μA |
| I_{OL} | LOW-level output current | $V_{RSTN} = 0.9\text{ V}$ | 1 | - | 5 | mA |
| V_{OL} | LOW-level output voltage | $V_{V1} = 1.5\text{ V}$ to 5.5 V ; pull-up resistor to $V1 \geq 4\text{ k}\Omega$ | 0 | - | $0.2 \times V_{V1}$ | V |
| $V_{IH(th)}$ | HIGH-level input threshold voltage | | $0.7 \times V_{V1}$ | - | $V_{V1} + 0.3$ | V |
| $V_{IL(th)}$ | LOW-level input threshold voltage | | -0.3 | - | $+0.3 \times V_{V1}$ | V |
| Enable output; pin EN | | | | | | |
| I_{OH} | HIGH-level output current | $V_{OH} = V_{V1} - 0.4\text{ V}$ | -20 | - | -1.6 | mA |
| I_{OL} | LOW-level output current | $V_{OL} = 0.4\text{ V}$ | 1.6 | - | 20 | mA |
| V_{OL} | LOW-level output voltage | $I_{OL} = 20\text{ }\mu\text{A}$; $V_{V1} = 1.2\text{ V}$ | 0 | - | 0.4 | V |
| Interrupt output; pin INTN | | | | | | |
| I_{OL} | LOW-level output current | $V_{OL} = 0.4\text{ V}$ | 1.6 | - | 15 | mA |
| CAN transmit data input; pin TXDC | | | | | | |
| V_{IH} | HIGH-level input voltage | | $0.7 \times V_{V1}$ | - | $V_{V1} + 0.3$ | V |
| V_{IL} | LOW-level input voltage | | -0.3 | - | $+0.3 \times V_{V1}$ | V |
| $R_{TXDC(pu)}$ | TXDC pull-up resistor | $V_{TXDC} = 0\text{ V}$ | 5 | 12 | 25 | $\text{k}\Omega$ |
| CAN receive data output; pin RXDC | | | | | | |
| I_{OH} | HIGH-level output current | $V_{OH} = V_{V1} - 0.4\text{ V}$ | -25 | - | -1.6 | mA |
| I_{OL} | LOW-level output current | $V_{OL} = 0.4\text{ V}$ | 1.6 | - | 25 | mA |

Table 26. Static characteristics ...continued

$T_{vj} = -40\text{ }^{\circ}\text{C}$ to $+150\text{ }^{\circ}\text{C}$, $V_{BAT42} = 5.5\text{ V}$ to 52 V ; $V_{BAT14} = 5.5\text{ V}$ to 27 V ; $V_{BAT42} \geq V_{BAT14} - 1\text{ V}$; unless otherwise specified. All voltages are defined with respect to ground. Positive currents flow into the IC.[\[1\]](#)

| Symbol | Parameter | Conditions | Min | Typ | Max | Unit |
|---|--|---|------|------|------|------|
| High-speed CAN-bus lines; pins CANH and CANL | | | | | | |
| $V_{o(dom)}$ | CANH dominant output voltage | Active mode; $V_{TXDC} = 0\text{ V}$; $V_{V2} = 4.75\text{ V}$ to 5.25 V | 2.85 | 3.6 | 4.25 | V |
| | CANL dominant output voltage | Active mode; $V_{TXDC} = 0\text{ V}$; $V_{V2} = 4.75\text{ V}$ to 5.25 V | 0.5 | 1.4 | 2 | V |
| $V_{o(m)(dom)}$ | matching of dominant output voltage | $R_L = 60\ \Omega$; $V_{o(m)(dom)} = V_{V2} - V_{CANH} - V_{CANL}$ | -0.3 | - | +0.3 | V |
| $V_{o(dif)}$ | differential bus output voltage | Active mode; $V_{TXDC} = 0\text{ V}$; $V_{V2} = 4.75\text{ V}$ to 5.25 V ; $R_L = 45\ \Omega$ to $65\ \Omega$ | 1.5 | - | 3 | V |
| | | Active mode, On-line mode or On-line Listen mode; $V_{TXDC} = V_{V1}$; $V_{V2} = 4.75\text{ V}$ to 5.25 V ; no load | -50 | 0 | +50 | mV |
| $V_{O(reces)}$ | recessive output voltage | Active mode, On-line mode or On-line Listen mode; $V_{TXDC} = V_{V1}$; $V_{V2} = 4.75\text{ V}$ to 5.25 V ; $R_L = 60\ \Omega$ | 2.25 | 2.5 | 2.75 | V |
| | | Off-line mode; $R_L = 60\ \Omega$ | -0.1 | 0 | +0.1 | V |
| $V_{th(dif)}$ | differential receiver threshold voltage | Active mode, On-line mode or On-line Listen mode; $V_{CAN} = -30\text{ V}$ to $+30\text{ V}$; $R_L = 60\ \Omega$ | 0.5 | 0.7 | 0.9 | V |
| | | Off-line mode; $V_{CAN} = -30\text{ V}$ to $+30\text{ V}$; $R_L = 60\ \Omega$; measured from recessive to dominant | 0.45 | 0.7 | 1.15 | V |
| $V_{th(GSD)(cm)}$ | common-mode bus voltage threshold level for ground shift detection | Active mode; $GSTHC = 0$; $V_{V2} = 5\text{ V}$; $R_L = 60\ \Omega$; $V_{cm} = 0.5 \times (V_{CANH} + V_{CANL})$ | 0.95 | 1.75 | 2.45 | V |
| | | Active mode; $GSTHC = 1$; $V_{V2} = 5\text{ V}$; $R_L = 60\ \Omega$; $V_{cm} = 0.5 \times (V_{CANH} + V_{CANL})$ | 0.3 | 1 | 1.5 | V |
| $I_{o(CANH)(dom)}$ | CANH dominant output current | Active mode; $t < t_{TXDC(dom)}$; $V_{CANH} = 0\text{ V}$; $V_{TXDC} = 0\text{ V}$; $V_{V2} = 5\text{ V}$ | -100 | -75 | -45 | mA |
| $I_{o(CANL)(dom)}$ | CANL dominant output current | Active mode; $t < t_{TXDC(dom)}$; $V_{CANL} = 5\text{ V}$; $V_{TXDC} = 0\text{ V}$; $V_{V2} = 5\text{ V}$ | 45 | 75 | 100 | mA |

Table 26. Static characteristics ...continued

$T_{vj} = -40\text{ °C to }+150\text{ °C}$, $V_{BAT42} = 5.5\text{ V to }52\text{ V}$; $V_{BAT14} = 5.5\text{ V to }27\text{ V}$; $V_{BAT42} \geq V_{BAT14} - 1\text{ V}$; unless otherwise specified. All voltages are defined with respect to ground. Positive currents flow into the IC.[\[1\]](#)

| Symbol | Parameter | Conditions | Min | Typ | Max | Unit |
|----------------|--|---|-----------------------|-----|-----|------------------|
| $I_{o(reces)}$ | recessive output current | all CAN modes; V2D = 1; $V_{TXDC} = V_{V1}$; $V_{CAN} = -40\text{ V to }+40\text{ V}$ | -5 | - | +5 | mA |
| | | Active mode, On-line mode or On-line Listen mode; V2D = 0; $V_{TXDC} = V_{V1}$; $V_{CAN} = -0.5\text{ V to }+5\text{ V}$ | -10 | - | +10 | μA |
| R_i | input resistance | Active mode, On-line mode or On-line Listen mode; V2D = 1; $V_{TXDC} = V_{V1}$; $V_{CAN} = -40\text{ V to }+40\text{ V}$ | 9 | 15 | 28 | $\text{k}\Omega$ |
| | | Off-line mode; $V_{CAN} = -40\text{ V to }+40\text{ V}$ | 15 | 22 | 40 | $\text{k}\Omega$ |
| $R_{i(m)}$ | input resistance matching | $V_{CANH} = V_{CANL}$ | -2 | 0 | +2 | % |
| $R_{i(dif)}$ | differential input resistance | | 19 | 30 | 52 | $\text{k}\Omega$ |
| $C_{i(cm)}$ | common-mode input capacitance | | [3] - | - | 20 | pF |
| $C_{i(dif)}$ | differential input capacitance | | [3] - | - | 10 | pF |
| $R_{sc(bus)}$ | detectable short-circuit resistance between bus lines and V_{V2} , V_{BAT14} , V_{BAT42} and GND | Active mode; $V_{TXDC} = 0\text{ V}$ | 0 | - | 50 | Ω |

CAN-bus common mode stabilization output; pin SPLIT

| | | | | | | |
|---------|-----------------|---|---------------------|---------------------|---------------------|---------------|
| V_o | output voltage | Active mode, On-line mode or On-line Listen mode; CSC = V2D = 1; $ I_{SPLIT} = 500\text{ }\mu\text{A}$ | $0.3 \times V_{V2}$ | $0.5 \times V_{V2}$ | $0.7 \times V_{V2}$ | V |
| $ I_L $ | leakage current | Off-line mode or CSC = 0; $V_{SPLIT} = -40\text{ V to }+40\text{ V}$ | -10 | 0 | +10 | μA |

TEST input; pin TEST

| | | | | | | |
|----------------|-------------------------|---|---|----|------|------------------|
| $V_{th(TESt)}$ | input threshold voltage | for entering Software development mode; $T_j = 25\text{ °C}$ | 1 | 5 | 8 | V |
| | | for entering Forced normal mode; $T_j = 25\text{ °C}$ | 2 | 10 | 13.5 | V |
| $R_{(pd)TESt}$ | pull-down resistor | between pin TEST and GND | 2 | 4 | 8 | $\text{k}\Omega$ |

Table 26. Static characteristics ...continued

$T_{vj} = -40\text{ }^{\circ}\text{C}$ to $+150\text{ }^{\circ}\text{C}$, $V_{BAT42} = 5.5\text{ V}$ to 52 V ; $V_{BAT14} = 5.5\text{ V}$ to 27 V ; $V_{BAT42} \geq V_{BAT14} - 1\text{ V}$; unless otherwise specified. All voltages are defined with respect to ground. Positive currents flow into the IC.^[1]

| Symbol | Parameter | Conditions | Min | Typ | Max | Unit |
|------------------------------|---|------------|-----|-----|-----|--------------------|
| Temperature detection | | | | | | |
| $T_{j(\text{warn})}$ | high junction temperature warning level | | 160 | 175 | 190 | $^{\circ}\text{C}$ |

- [1] All parameters are guaranteed over the virtual junction temperature range by design. Products are 100 % tested at 125 $^{\circ}\text{C}$ ambient temperature on wafer level (pretesting). Cased products are 100 % tested at 25 $^{\circ}\text{C}$ ambient temperature (final testing). Both pretesting and final testing use correlated test conditions to cover the specified temperature and power supply voltage range.
- [2] $V_{V1(\text{nom})}$ is 3.3 V or 5 V, depending on the SBC version.
- [3] Not tested in production.
- [4] V2 internally supplies the SBC CAN transceiver. The supply current needed for the CAN transceiver reduces the pin V2 output capability. The performance of the CAN transceiver can be impaired if V2 is also used to supply other circuitry while the CAN transceiver is in use.

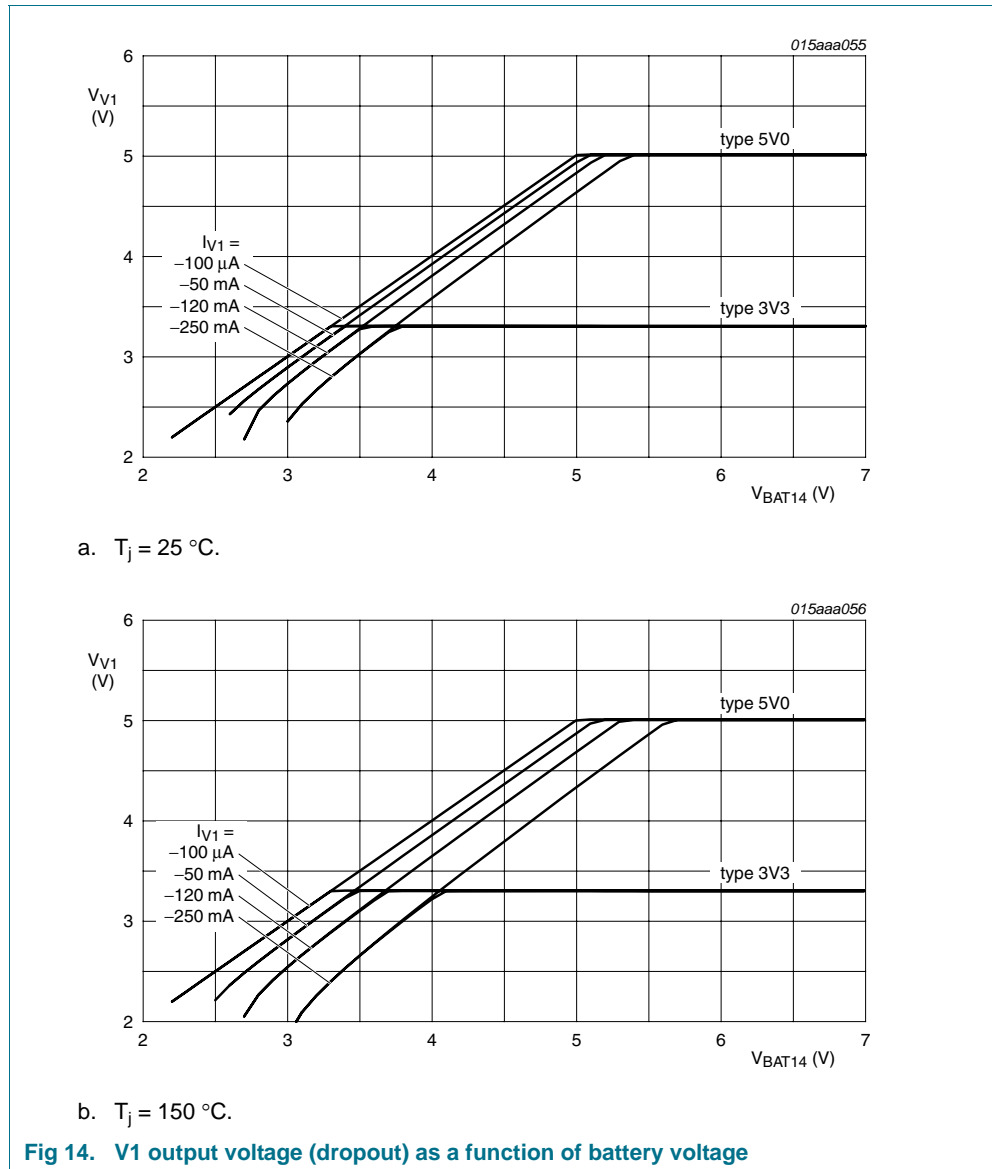

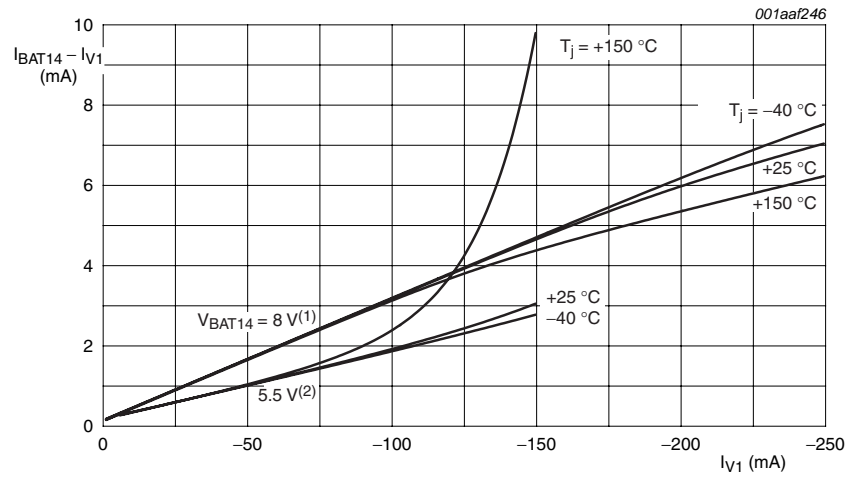

- (1) Types 5V0 and 3V3.
- (2) Type 5V0 only.
- a. At $T_j = -40\text{ }^\circ\text{C}$, $+25\text{ }^\circ\text{C}$ and $+150\text{ }^\circ\text{C}$.

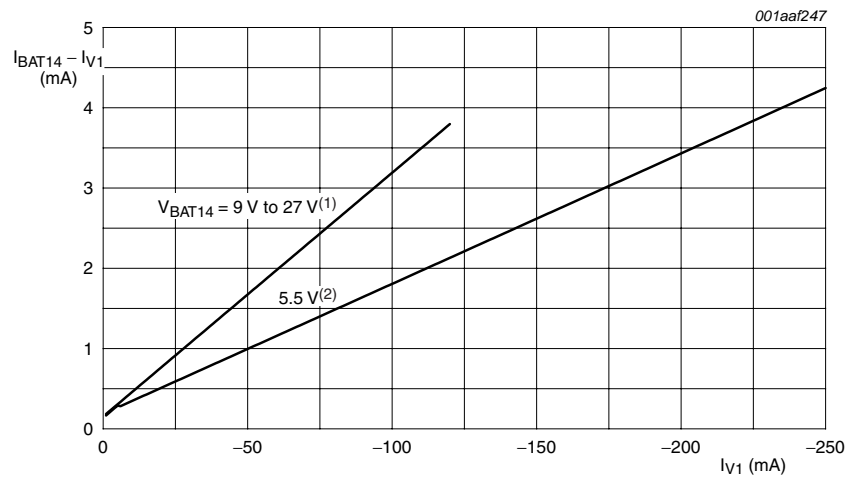

- (1) Types 5V0 and 3V3.
- (2) Types 3V3 only.
- b. At $T_j = -40\text{ }^\circ\text{C}$ to $+150\text{ }^\circ\text{C}$.

Fig 15. V1 quiescent current as a function of output current

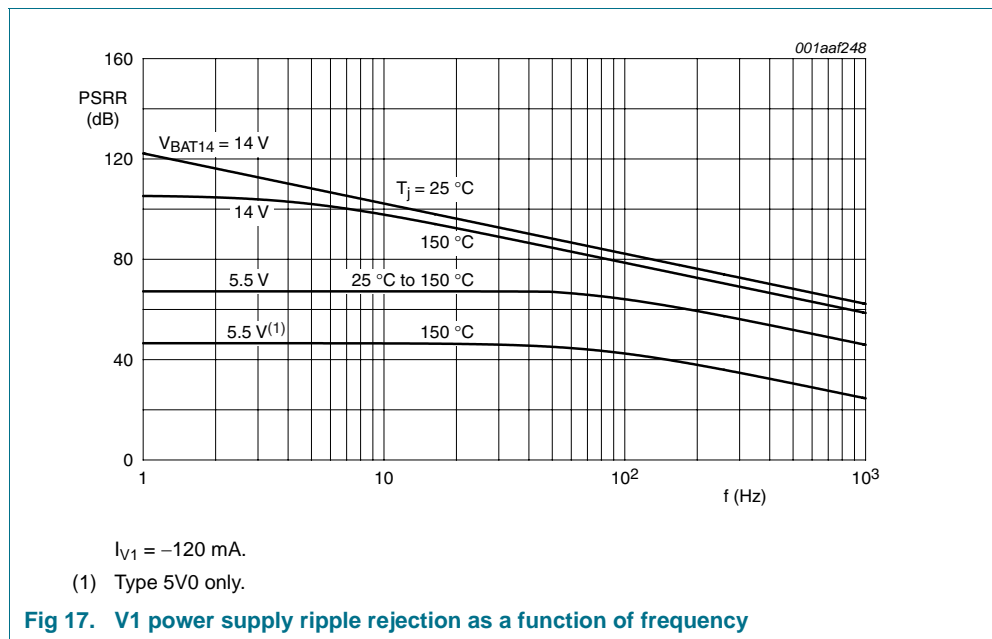
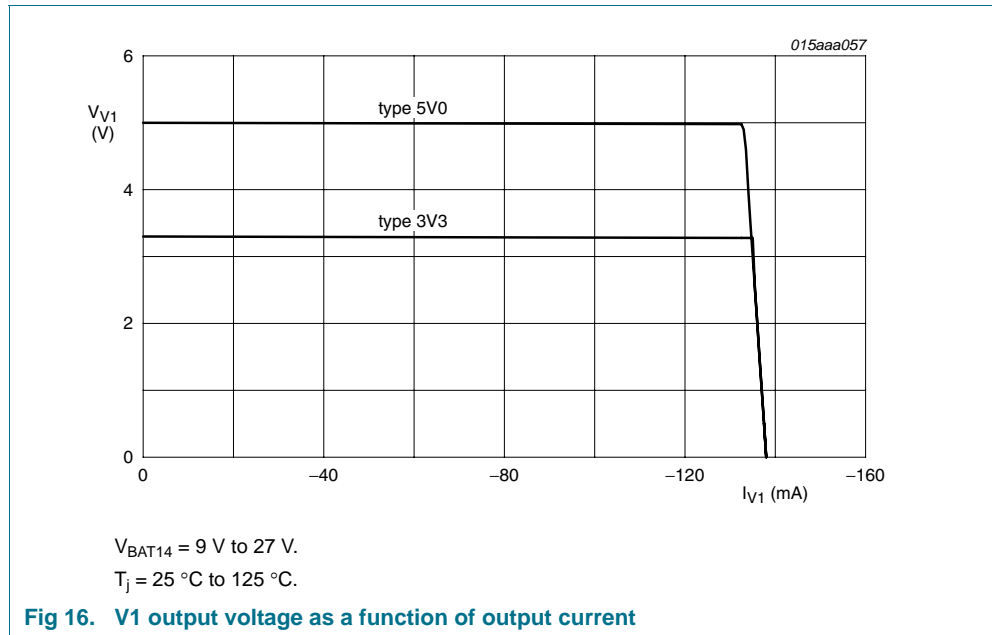

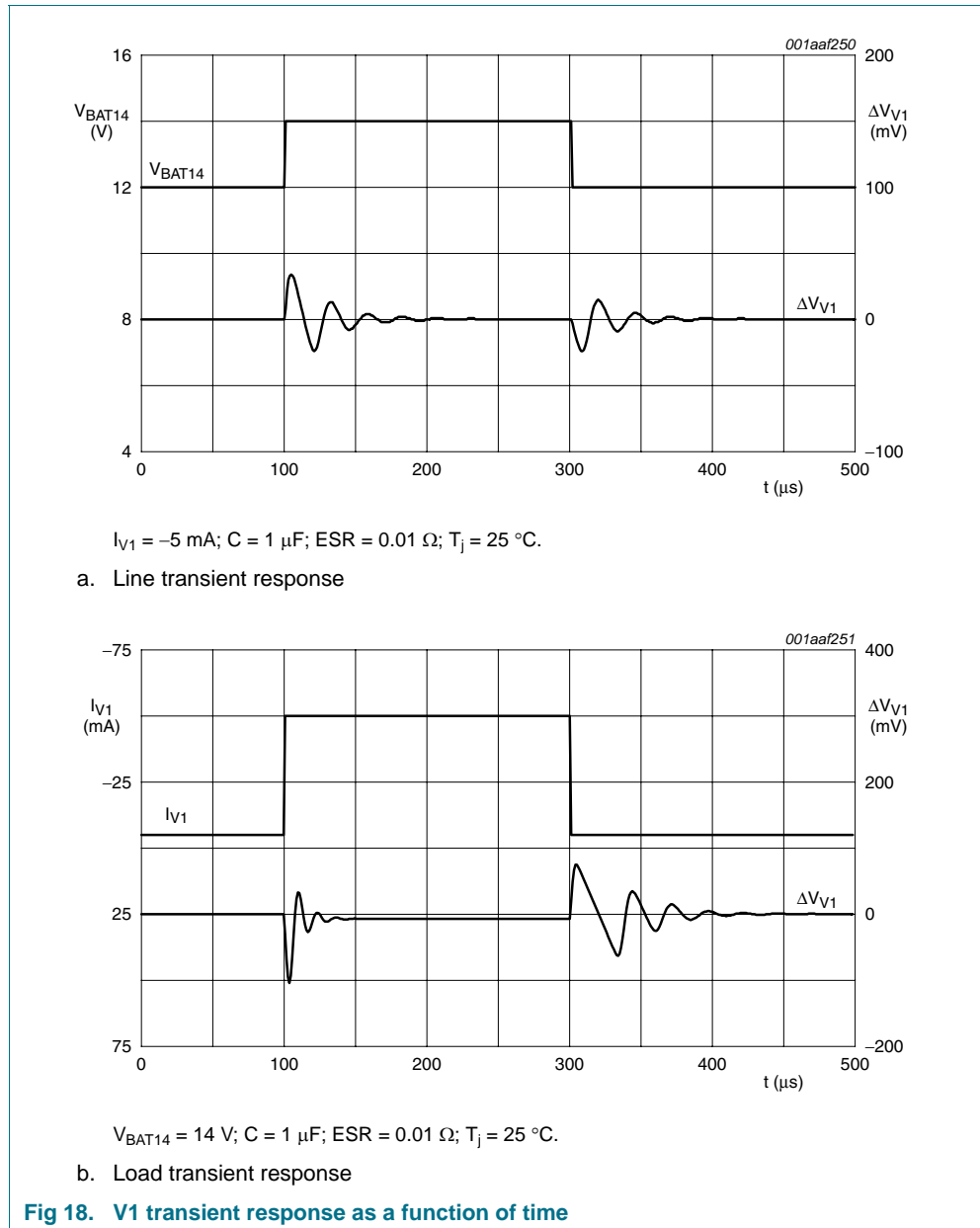

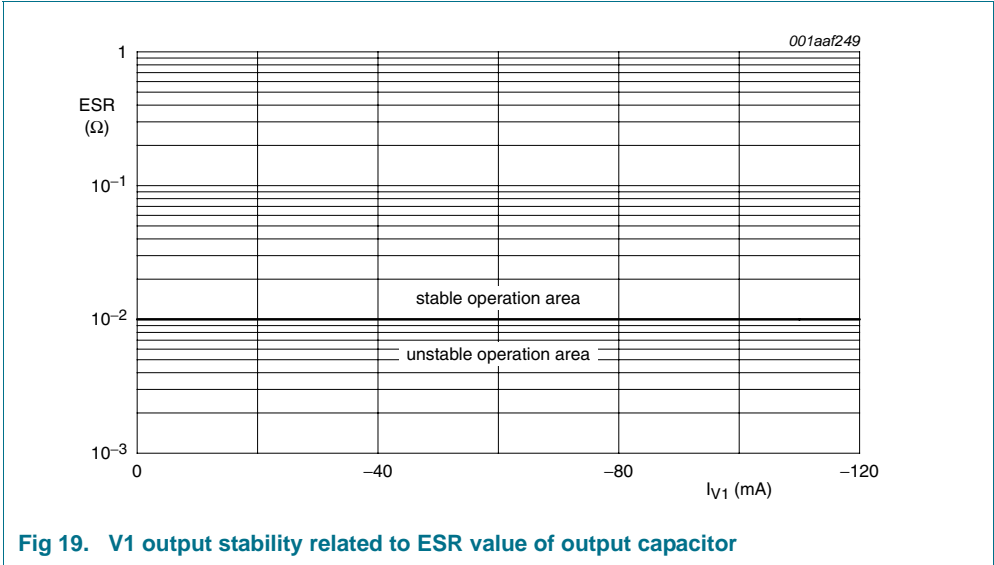

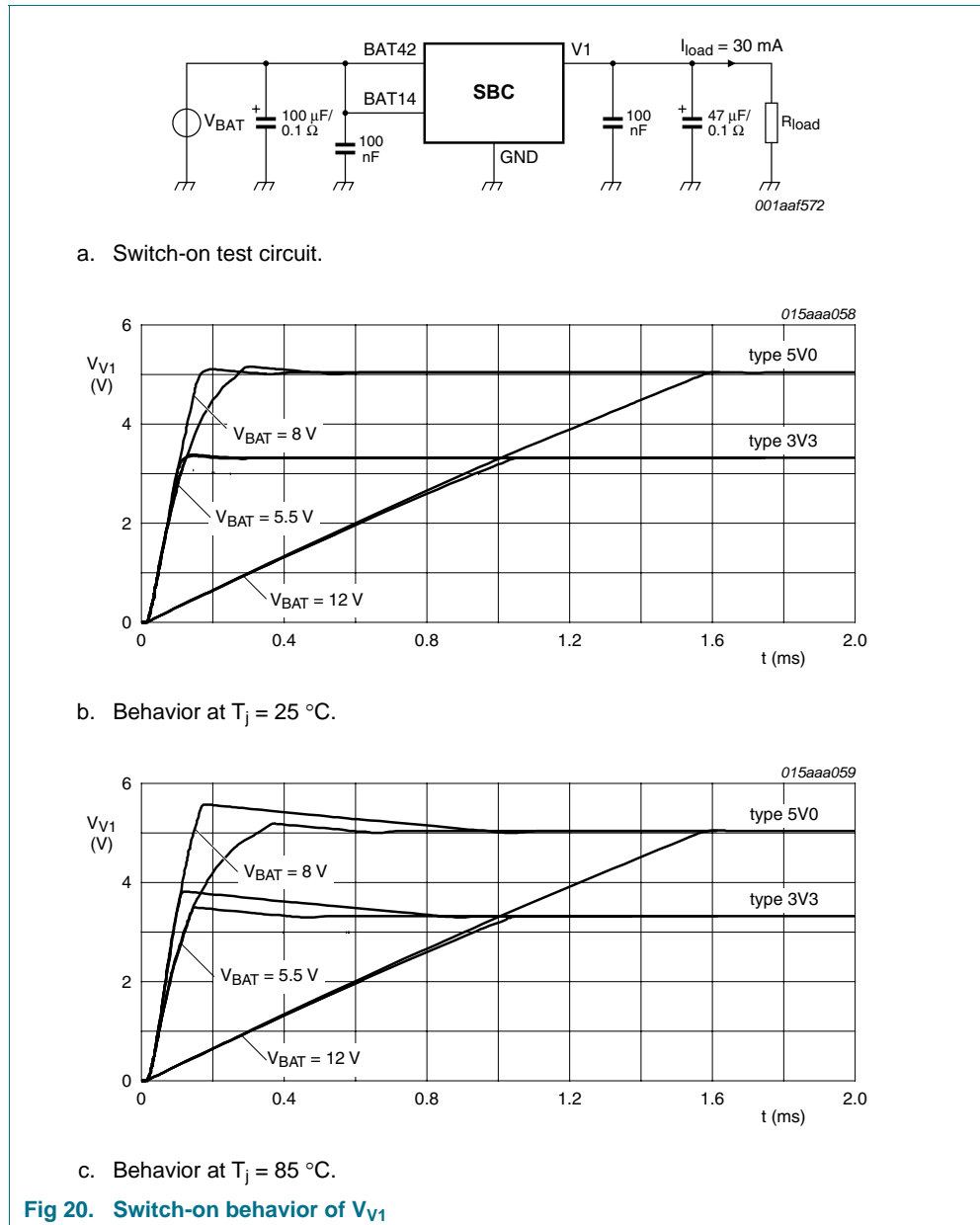

10. Dynamic characteristics

Table 27. Dynamic characteristics

$T_{vj} = -40\text{ }^{\circ}\text{C}$ to $+150\text{ }^{\circ}\text{C}$; $V_{BAT42} = 5.5\text{ V}$ to 52 V ; $V_{BAT14} = 5.5\text{ V}$ to 27 V ; $V_{BAT42} \geq V_{BAT14} - 1\text{ V}$; unless otherwise specified. All voltages are defined with respect to ground. Positive currents flow into the IC.[\[1\]](#)

| Symbol | Parameter | Conditions | Min | Typ | Max | Unit |
|--|---|---|-----|-----|-----|---------------|
| Serial peripheral interface timing; pins SCS, SCK, SDI and SDO (see Figure 21)[2] | | | | | | |
| T_{cyc} | clock cycle time | | 960 | - | - | ns |
| t_{lead} | enable lead time | clock is LOW when SPI select falls | 240 | - | - | ns |
| t_{lag} | enable lag time | clock is LOW when SPI select rises | 240 | - | - | ns |
| t_{SCKH} | clock HIGH time | | 480 | - | - | ns |
| t_{SCKL} | clock LOW time | | 480 | - | - | ns |
| t_{su} | input data setup time | | 80 | - | - | ns |
| t_h | input data hold time | | 400 | - | - | ns |
| t_{DOV} | output data valid time | pin SDO; $C_L = 10\text{ pF}$ | - | - | 400 | ns |
| t_{SSH} | SPI select HIGH time | | 480 | - | - | ns |
| CAN transceiver timing; pins CANL, CANH, TXDC and RXDC | | | | | | |
| $t_{t(reces-dom)}$ | output transition time recessive to dominant | 10 % to 90 %; $C = 100\text{ pF}$; $R = 60\text{ }\Omega$; see Figure 22 and Figure 23 | - | 100 | - | ns |
| $t_{t(dom-reces)}$ | output transition time dominant to recessive | 90 % to 10 %; $C = 100\text{ pF}$; $R = 60\text{ }\Omega$; see Figure 22 and Figure 23 | - | 100 | - | ns |
| t_{PHL} | propagation delay TXDC to RXDC (HIGH-to-LOW transition) | 50 % V_{TXDC} to 50 % V_{RXDC} ; $C = 100\text{ pF}$; $R = 60\text{ }\Omega$; see Figure 22 and Figure 23 | 70 | 120 | 220 | ns |
| t_{PLH} | propagation delay TXDC to RXDC (LOW-to-HIGH transition) | 50 % V_{TXDC} to 50 % V_{RXDC} ; $C = 100\text{ pF}$; $R = 60\text{ }\Omega$; see Figure 22 and Figure 23 | 70 | 120 | 220 | ns |
| $t_{TXDC(dom)}$ | TXDC permanent dominant disable time | Active mode, On-line mode or On-line Listen mode; $V_{V2} = 5\text{ V}$; $V_{TXDC} = 0\text{ V}$ | 1.5 | - | 6 | ms |
| $t_{CANH(dom1)}$, $t_{CANL(dom1)}$ | minimum dominant time first pulse for wake-up on pins CANH and CANL | Off-line mode | 3 | - | - | μs |
| $t_{CANH(reces)}$, $t_{CANL(reces)}$ | minimum recessive time pulse (after first dominant) for wake-up on pins CANH and CANL | Off-line mode | 1 | - | - | μs |
| $t_{CANH(dom2)}$, $t_{CANL(dom2)}$ | minimum dominant time second pulse for wake-up on pins CANH, CANL | Off-line mode | 1 | - | - | μs |
| $t_{timeout}$ | time-out period between wake-up message and confirm message | On-line Listen mode | 115 | - | 285 | ms |

Table 27. Dynamic characteristics ...continued

$T_{vj} = -40\text{ °C to }+150\text{ °C}$; $V_{BAT42} = 5.5\text{ V to }52\text{ V}$; $V_{BAT14} = 5.5\text{ V to }27\text{ V}$; $V_{BAT42} \geq V_{BAT14} - 1\text{ V}$; unless otherwise specified. All voltages are defined with respect to ground. Positive currents flow into the IC.[U1](#)

| Symbol | Parameter | Conditions | Min | Typ | Max | Unit |
|--------------------------------|---|--|--------------------------|-----|--------------------------|---------------|
| $t_{\text{off-line}}$ | maximum time before entering Off-line mode | On-line or On-line Listen mode; TXDC = V_{V1} ; V2D = 1; COTC = 0; no bus activity | 50 | - | 66 | ms |
| | | On-line or On-line Listen mode; TXDC = V_{V1} ; V2D = 1; COTC = 1; no bus activity | 200 | - | 265 | ms |
| $t_{\text{off-line(ext)}}$ | extended minimum time before entering Off-line mode | On-line or On-line Listen mode after CAN wake-up event; TXDC = V_{V1} ; V2D = 1; no bus activity | 400 | - | 530 | ms |
| Battery monitoring | | | | | | |
| $t_{\text{BAT42(L)}}$ | BAT42 LOW time for setting PWONS | | 5 | - | 20 | μs |
| $t_{\text{SENSE(L)}}$ | BAT42 LOW time for setting BATFI | | 5 | - | 20 | μs |
| Power supply V1; pin V1 | | | | | | |
| $t_{V1(\text{CLT})}$ | V1 clamped LOW time during ramp-up of V1 | Start-up mode; V1 active | 229 | - | 283 | ms |
| Power supply V2; pin V2 | | | | | | |
| $t_{V2(\text{CLT})}$ | V2 clamped LOW time during ramp-up of V2 | V2 active | 28 | - | 36 | ms |
| Power supply V3; pin V3 | | | | | | |
| $t_w(\text{CS})$ | cyclic sense period | V3C[1:0] = 10; see Figure 11 | 14 | - | 18 | ms |
| | | V3C[1:0] = 11; see Figure 11 | 28 | - | 36 | ms |
| $t_{\text{on}}(\text{CS})$ | cyclic sense on-time | V3C[1:0] = 10; see Figure 11 | 345 | - | 423 | μs |
| | | V3C[1:0] = 11; see Figure 11 | 345 | - | 423 | μs |
| Wake-up input; pin WAKE | | | | | | |
| $t_{\text{WU(ipf)}}$ | input port filter time | $V_{\text{BAT42}} = 5\text{ V to }27\text{ V}$ | 5 | - | 120 | μs |
| | | $V_{\text{BAT42}} = 27\text{ V to }52\text{ V}$ | 30 | - | 250 | μs |
| $t_{\text{su}}(\text{CS})$ | cyclic sense sample setup time | V3C[1:0] = 11 or 10; see Figure 11 | 310 | - | 390 | μs |
| Watchdog | | | | | | |
| $t_{\text{WD(ETP)}}$ | earliest watchdog trigger point | programmed Nominal Watchdog Period (NWP); Normal mode | $0.45 \times \text{NWP}$ | - | $0.55 \times \text{NWP}$ | |
| $t_{\text{WD(LTP)}}$ | latest watchdog trigger point | programmed nominal watchdog period; Normal mode, Standby mode and Sleep mode | $0.9 \times \text{NWP}$ | - | $1.1 \times \text{NWP}$ | |
| $t_{\text{WD(init)}}$ | watchdog initializing period | watchdog time-out in Start-up mode | 229 | - | 283 | ms |
| Fail-safe mode | | | | | | |
| t_{ret} | retention time | Fail-safe mode; wake-up detected | 1.3 | 1.5 | 1.7 | s |

Table 27. Dynamic characteristics ...continued

$T_{vj} = -40\text{ }^{\circ}\text{C}$ to $+150\text{ }^{\circ}\text{C}$; $V_{BAT42} = 5.5\text{ V}$ to 52 V ; $V_{BAT14} = 5.5\text{ V}$ to 27 V ; $V_{BAT42} \geq V_{BAT14} - 1\text{ V}$; unless otherwise specified. All voltages are defined with respect to ground. Positive currents flow into the IC.[U1](#)

| Symbol | Parameter | Conditions | Min | Typ | Max | Unit |
|-----------------------------------|-----------------------------|---|-------|-----|-------|---------------|
| Reset output; pin RSTN | | | | | | |
| $t_{RSTN(HT)}$ | clamped HIGH time, pin RSTN | RSTN driven LOW internally but RSTN pin remains HIGH | 115 | - | 141 | ms |
| $t_{RSTN(LT)}$ | clamped LOW time, pin RSTN | RSTN driven HIGH internally but RSTN pin remains LOW | 229 | - | 283 | ms |
| $t_{RSTN(INT)}$ | interrupt monitoring time | INTN = 0 | 229 | - | 283 | ms |
| t_{RSTNL} | reset lengthening time | after internal or external reset has been released; RLC = 0 | 0.9 | - | 1.1 | ms |
| | | after internal or external reset has been released; RLC = 1 | 18 | - | 22 | ms |
| Interrupt output; pin INTN | | | | | | |
| t_{INTN} | interrupt release | after SPI has read out the Interrupt register | 2 | - | - | μs |
| Oscillator | | | | | | |
| f_{osc} | oscillator frequency | | 460.8 | 512 | 563.2 | kHz |

- [1] All parameters are guaranteed over the virtual junction temperature range by design. Products are 100 % tested at 125 °C ambient temperature on wafer level (pretesting). Cased products are 100 % tested at 25 °C ambient temperature (final testing). Both pretesting and final testing use correlated test conditions to cover the specified temperature and power supply voltage range.
- [2] SPI timing is guaranteed for V_{BAT42} voltages down to 5 V. For V_{BAT42} voltages down to 4.5 V the guaranteed SPI timing values double, so at these lower voltages a lower maximum SPI communication speed must be observed.

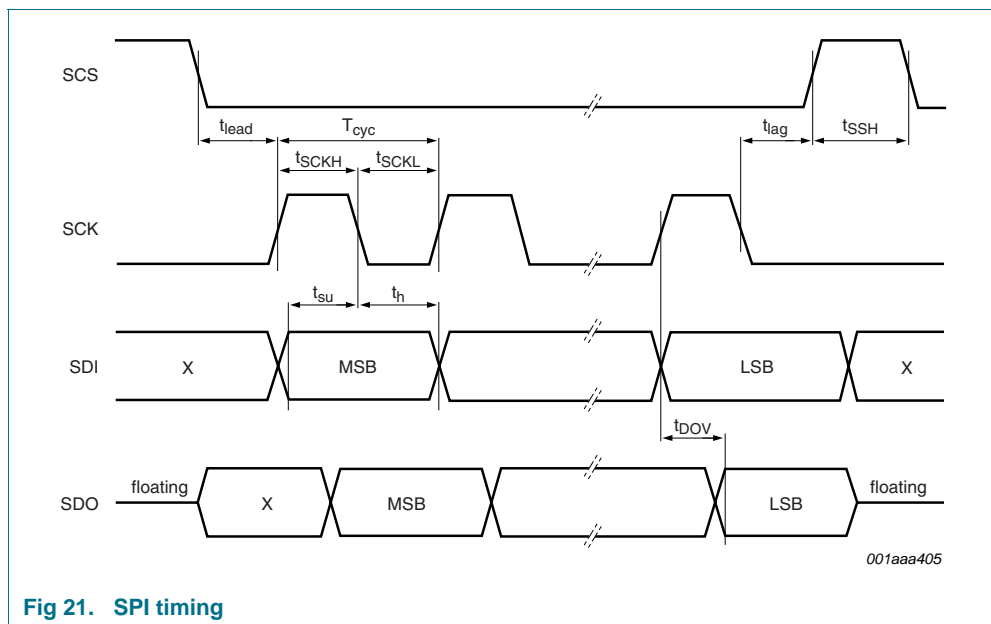

Fig 21. SPI timing

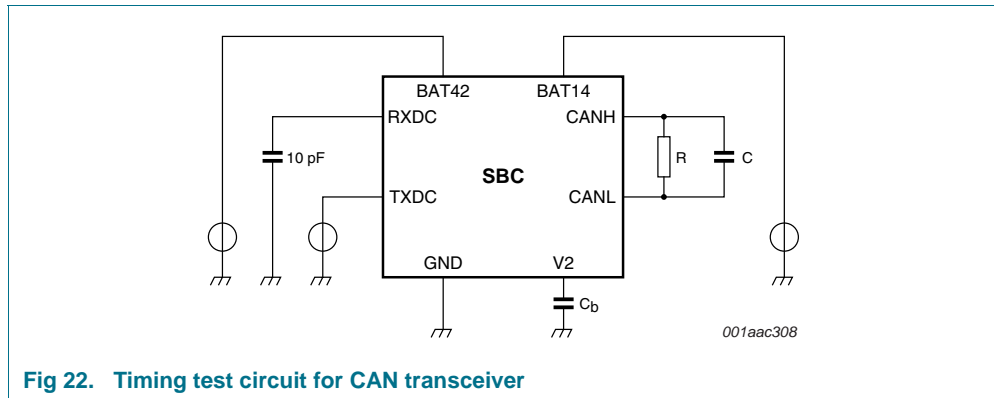

Fig 22. Timing test circuit for CAN transceiver

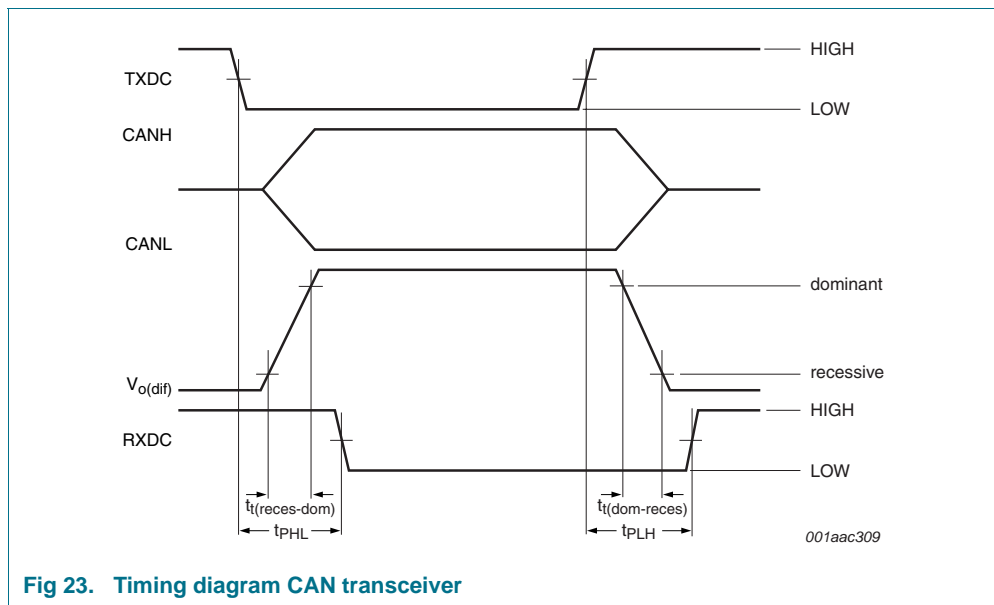

Fig 23. Timing diagram CAN transceiver

11. Test information

11.1 Quality information

This product has been qualified to the appropriate Automotive Electronics Council (AEC) standard Q100 or Q101 and is suitable for use in automotive applications.

12. Package outline

HTSSOP32: plastic thermal enhanced thin shrink small outline package; 32 leads; body width 6.1 mm; lead pitch 0.65 mm; exposed die pad

SOT549-1

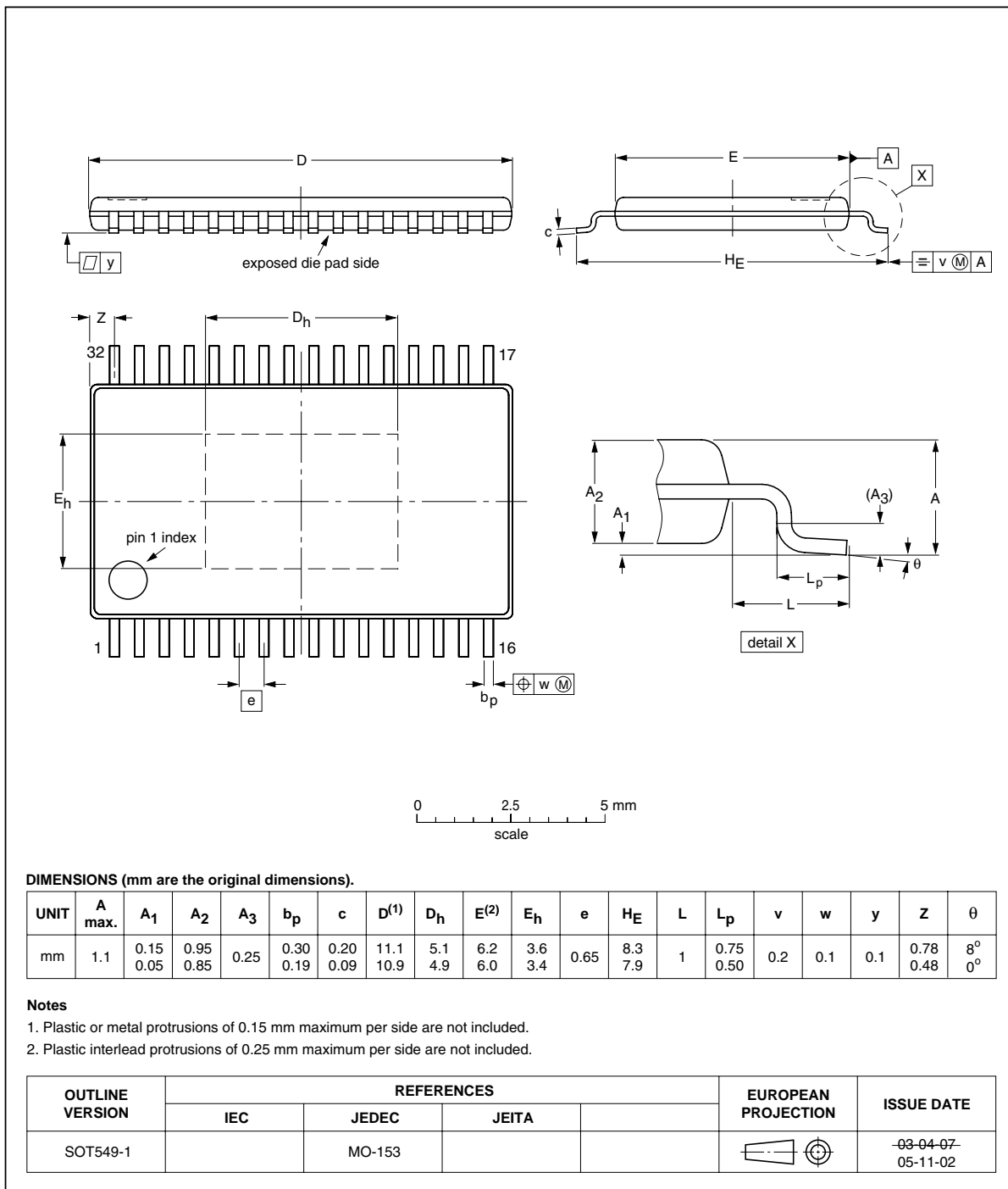

Fig 24. Package outline SOT549-1 (HTSSOP32)

13. Soldering of SMD packages

This text provides a very brief insight into a complex technology. A more in-depth account of soldering ICs can be found in Application Note *AN10365 "Surface mount reflow soldering description"*.

13.1 Introduction to soldering

Soldering is one of the most common methods through which packages are attached to Printed Circuit Boards (PCBs), to form electrical circuits. The soldered joint provides both the mechanical and the electrical connection. There is no single soldering method that is ideal for all IC packages. Wave soldering is often preferred when through-hole and Surface Mount Devices (SMDs) are mixed on one printed wiring board; however, it is not suitable for fine pitch SMDs. Reflow soldering is ideal for the small pitches and high densities that come with increased miniaturization.

13.2 Wave and reflow soldering

Wave soldering is a joining technology in which the joints are made by solder coming from a standing wave of liquid solder. The wave soldering process is suitable for the following:

- Through-hole components
- Leaded or leadless SMDs, which are glued to the surface of the printed circuit board

Not all SMDs can be wave soldered. Packages with solder balls, and some leadless packages which have solder lands underneath the body, cannot be wave soldered. Also, leaded SMDs with leads having a pitch smaller than ~0.6 mm cannot be wave soldered, due to an increased probability of bridging.

The reflow soldering process involves applying solder paste to a board, followed by component placement and exposure to a temperature profile. Leaded packages, packages with solder balls, and leadless packages are all reflow solderable.

Key characteristics in both wave and reflow soldering are:

- Board specifications, including the board finish, solder masks and vias
- Package footprints, including solder thieves and orientation
- The moisture sensitivity level of the packages
- Package placement
- Inspection and repair
- Lead-free soldering versus SnPb soldering

13.3 Wave soldering

Key characteristics in wave soldering are:

- Process issues, such as application of adhesive and flux, clinching of leads, board transport, the solder wave parameters, and the time during which components are exposed to the wave
- Solder bath specifications, including temperature and impurities

13.4 Reflow soldering

Key characteristics in reflow soldering are:

- Lead-free versus SnPb soldering; note that a lead-free reflow process usually leads to higher minimum peak temperatures (see [Figure 25](#)) than a SnPb process, thus reducing the process window
- Solder paste printing issues including smearing, release, and adjusting the process window for a mix of large and small components on one board
- Reflow temperature profile; this profile includes preheat, reflow (in which the board is heated to the peak temperature) and cooling down. It is imperative that the peak temperature is high enough for the solder to make reliable solder joints (a solder paste characteristic). In addition, the peak temperature must be low enough that the packages and/or boards are not damaged. The peak temperature of the package depends on package thickness and volume and is classified in accordance with [Table 28](#) and [29](#)

Table 28. SnPb eutectic process (from J-STD-020C)

| Package thickness (mm) | Package reflow temperature (°C) | |
|------------------------|---------------------------------|-------|
| | Volume (mm ³) | |
| | < 350 | ≥ 350 |
| < 2.5 | 235 | 220 |
| ≥ 2.5 | 220 | 220 |

Table 29. Lead-free process (from J-STD-020C)

| Package thickness (mm) | Package reflow temperature (°C) | | |
|------------------------|---------------------------------|-------------|--------|
| | Volume (mm ³) | | |
| | < 350 | 350 to 2000 | > 2000 |
| < 1.6 | 260 | 260 | 260 |
| 1.6 to 2.5 | 260 | 250 | 245 |
| > 2.5 | 250 | 245 | 245 |

Moisture sensitivity precautions, as indicated on the packing, must be respected at all times.

Studies have shown that small packages reach higher temperatures during reflow soldering, see [Figure 25](#).

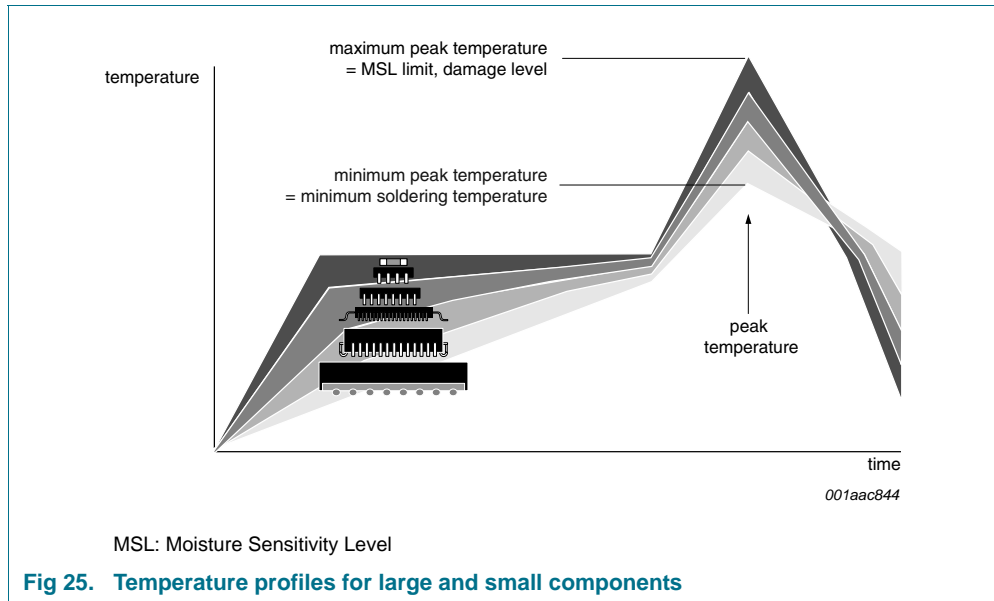

For further information on temperature profiles, refer to Application Note AN10365 "Surface mount reflow soldering description".

14. Revision history

Table 30. Revision history

| Document ID | Release date | Data sheet status | Change notice | Supersedes |
|----------------|--|----------------------|---------------|------------|
| UJA1066_3 | 20100317 | Product data sheet | - | UJA1066_2 |
| Modifications: | • Error in Figure 20 corrected | | | |
| UJA1066_2 | 20090505 | Product data sheet | - | UJA1066_1 |
| UJA1066_1 | 20070424 | Objective data sheet | - | - |

15. Legal information

15.1 Data sheet status

| Document status ^{[1][2]} | Product status ^[3] | Definition |
|-----------------------------------|-------------------------------|---|
| Objective [short] data sheet | Development | This document contains data from the objective specification for product development. |
| Preliminary [short] data sheet | Qualification | This document contains data from the preliminary specification. |
| Product [short] data sheet | Production | This document contains the product specification. |

[1] Please consult the most recently issued document before initiating or completing a design.

[2] The term 'short data sheet' is explained in section "Definitions".

[3] The product status of device(s) described in this document may have changed since this document was published and may differ in case of multiple devices. The latest product status information is available on the Internet at URL <http://www.nxp.com>.

15.2 Definitions

Draft — The document is a draft version only. The content is still under internal review and subject to formal approval, which may result in modifications or additions. NXP Semiconductors does not give any representations or warranties as to the accuracy or completeness of information included herein and shall have no liability for the consequences of use of such information.

Short data sheet — A short data sheet is an extract from a full data sheet with the same product type number(s) and title. A short data sheet is intended for quick reference only and should not be relied upon to contain detailed and full information. For detailed and full information see the relevant full data sheet, which is available on request via the local NXP Semiconductors sales office. In case of any inconsistency or conflict with the short data sheet, the full data sheet shall prevail.

Product specification — The information and data provided in a Product data sheet shall define the specification of the product as agreed between NXP Semiconductors and its customer, unless NXP Semiconductors and customer have explicitly agreed otherwise in writing. In no event however, shall an agreement be valid in which the NXP Semiconductors product is deemed to offer functions and qualities beyond those described in the Product data sheet.

15.3 Disclaimers

Limited warranty and liability — Information in this document is believed to be accurate and reliable. However, NXP Semiconductors does not give any representations or warranties, expressed or implied, as to the accuracy or completeness of such information and shall have no liability for the consequences of use of such information.

In no event shall NXP Semiconductors be liable for any indirect, incidental, punitive, special or consequential damages (including - without limitation - lost profits, lost savings, business interruption, costs related to the removal or replacement of any products or rework charges) whether or not such damages are based on tort (including negligence), warranty, breach of contract or any other legal theory.

Notwithstanding any damages that customer might incur for any reason whatsoever, NXP Semiconductors' aggregate and cumulative liability towards customer for the products described herein shall be limited in accordance with the *Terms and conditions of commercial sale* of NXP Semiconductors.

Right to make changes — NXP Semiconductors reserves the right to make changes to information published in this document, including without limitation specifications and product descriptions, at any time and without notice. This document supersedes and replaces all information supplied prior to the publication hereof.

Suitability for use — NXP Semiconductors products are not designed, authorized or warranted to be suitable for use in medical, military, aircraft, space or life support equipment, nor in applications where failure or

malfunction of an NXP Semiconductors product can reasonably be expected to result in personal injury, death or severe property or environmental damage. NXP Semiconductors accepts no liability for inclusion and/or use of NXP Semiconductors products in such equipment or applications and therefore such inclusion and/or use is at the customer's own risk.

Applications — Applications that are described herein for any of these products are for illustrative purposes only. NXP Semiconductors makes no representation or warranty that such applications will be suitable for the specified use without further testing or modification.

NXP Semiconductors does not accept any liability related to any default, damage, costs or problem which is based on a weakness or default in the customer application/use or the application/use of customer's third party customer(s) (hereinafter both referred to as "Application"). It is customer's sole responsibility to check whether the NXP Semiconductors product is suitable and fit for the Application planned. Customer has to do all necessary testing for the Application in order to avoid a default of the Application and the product. NXP Semiconductors does not accept any liability in this respect.

Limiting values — Stress above one or more limiting values (as defined in the Absolute Maximum Ratings System of IEC 60134) will cause permanent damage to the device. Limiting values are stress ratings only and (proper) operation of the device at these or any other conditions above those given in the Recommended operating conditions section (if present) or the Characteristics sections of this document is not warranted. Constant or repeated exposure to limiting values will permanently and irreversibly affect the quality and reliability of the device.

Terms and conditions of commercial sale — NXP Semiconductors products are sold subject to the general terms and conditions of commercial sale, as published at <http://www.nxp.com/profile/terms>, unless otherwise agreed in a valid written individual agreement. In case an individual agreement is concluded only the terms and conditions of the respective agreement shall apply. NXP Semiconductors hereby expressly objects to applying the customer's general terms and conditions with regard to the purchase of NXP Semiconductors products by customer.

No offer to sell or license — Nothing in this document may be interpreted or construed as an offer to sell products that is open for acceptance or the grant, conveyance or implication of any license under any copyrights, patents or other industrial or intellectual property rights.

Export control — This document as well as the item(s) described herein may be subject to export control regulations. Export might require a prior authorization from national authorities.

Quick reference data — The Quick reference data is an extract of the product data given in the Limiting values and Characteristics sections of this document, and as such is not complete, exhaustive or legally binding.

Non-automotive qualified products — Unless this data sheet expressly states that this specific NXP Semiconductors product is automotive qualified, the product is not suitable for automotive use. It is neither qualified nor tested in accordance with automotive testing or application requirements. NXP Semiconductors accepts no liability for inclusion and/or use of non-automotive qualified products in automotive equipment or applications.

In the event that customer uses the product for design-in and use in automotive applications to automotive specifications and standards, customer (a) shall use the product without NXP Semiconductors' warranty of the product for such automotive applications, use and specifications, and (b) whenever customer uses the product for automotive applications beyond NXP Semiconductors' specifications such use shall be solely at customer's own risk, and (c) customer fully indemnifies NXP Semiconductors for any

liability, damages or failed product claims resulting from customer design and use of the product for automotive applications beyond NXP Semiconductors' standard warranty and NXP Semiconductors' product specifications.

15.4 Trademarks

Notice: All referenced brands, product names, service names and trademarks are the property of their respective owners.

16. Contact information

For more information, please visit: <http://www.nxp.com>

For sales office addresses, please send an email to: salesaddresses@nxp.com

17. Contents

| | | | | | |
|----------|---|----------|-----------|---|-----------|
| 1 | General description | 1 | 6.7.4.1 | TXDC dominant clamping | 22 |
| 2 | Features and benefits | 2 | 6.7.4.2 | RXDC recessive clamping | 22 |
| 2.1 | General | 2 | 6.7.4.3 | GND shift detection | 23 |
| 2.2 | CAN transceiver | 2 | 6.8 | Inhibit and limp-home output | 23 |
| 2.3 | Power management | 3 | 6.9 | Wake-up input | 23 |
| 2.4 | Fail-safe features | 3 | 6.10 | Interrupt output | 24 |
| 3 | Ordering information | 4 | 6.11 | Temperature protection | 24 |
| 4 | Block diagram | 4 | 6.12 | SPI interface | 25 |
| 5 | Pinning information | 5 | 6.12.1 | SPI register mapping | 26 |
| 5.1 | Pinning | 5 | 6.12.2 | Register overview | 26 |
| 5.2 | Pin description | 5 | 6.12.3 | Mode register | 27 |
| 6 | Functional description | 7 | 6.12.4 | System Status register | 29 |
| 6.1 | Introduction | 7 | 6.12.5 | System Diagnosis register | 30 |
| 6.2 | Fail-safe system controller | 7 | 6.12.6 | Interrupt Enable register and Interrupt Enable Feedback register | 32 |
| 6.2.1 | Start-up mode | 9 | 6.12.7 | Interrupt register | 33 |
| 6.2.2 | Restart mode | 9 | 6.12.8 | System Configuration register and System Configuration Feedback register | 35 |
| 6.2.3 | Fail-safe mode | 9 | 6.12.9 | Physical Layer Control register and Physical Layer Control Feedback register | 36 |
| 6.2.4 | Normal mode | 9 | 6.12.10 | Special Mode register and Special Mode Feedback register | 36 |
| 6.2.5 | Standby mode | 10 | 6.12.11 | General Purpose registers and General Purpose Feedback registers | 38 |
| 6.2.6 | Sleep mode | 11 | 6.12.12 | Register configurations at reset | 38 |
| 6.2.7 | Flash mode | 11 | 6.13 | Test modes | 41 |
| 6.3 | On-chip oscillator | 12 | 6.13.1 | Software development mode | 41 |
| 6.4 | Watchdog | 12 | 6.13.2 | Forced normal mode | 42 |
| 6.4.1 | Watchdog start-up behavior | 13 | 7 | Limiting values | 42 |
| 6.4.2 | Watchdog window behavior | 13 | 8 | Thermal characteristics | 44 |
| 6.4.3 | Watchdog time-out behavior | 14 | 9 | Static characteristics | 44 |
| 6.4.4 | Watchdog OFF behavior | 14 | 10 | Dynamic characteristics | 58 |
| 6.5 | System reset | 15 | 11 | Test information | 61 |
| 6.5.1 | RSTN pin | 15 | 11.1 | Quality information | 61 |
| 6.5.2 | EN output | 17 | 12 | Package outline | 62 |
| 6.6 | Power supplies | 17 | 13 | Soldering of SMD packages | 63 |
| 6.6.1 | BAT14, BAT42 and SYSINH | 17 | 13.1 | Introduction to soldering | 63 |
| 6.6.1.1 | SYSINH output | 18 | 13.2 | Wave and reflow soldering | 63 |
| 6.6.2 | SENSE input | 18 | 13.3 | Wave soldering | 63 |
| 6.6.3 | Voltage regulators V1 and V2 | 18 | 13.4 | Reflow soldering | 64 |
| 6.6.3.1 | Voltage regulator V1 | 18 | 14 | Revision history | 66 |
| 6.6.3.2 | Voltage regulator V2 | 18 | 15 | Legal information | 67 |
| 6.6.4 | Switched battery output V3 | 19 | 15.1 | Data sheet status | 67 |
| 6.7 | CAN transceiver | 19 | 15.2 | Definitions | 67 |
| 6.7.1 | Mode control | 19 | 15.3 | Disclaimers | 67 |
| 6.7.1.1 | Active mode | 20 | 15.4 | Trademarks | 68 |
| 6.7.1.2 | On-line mode | 21 | | | |
| 6.7.1.3 | On-line Listen mode | 21 | | | |
| 6.7.1.4 | Off-line mode | 21 | | | |
| 6.7.2 | CAN wake-up | 21 | | | |
| 6.7.3 | Termination control | 22 | | | |
| 6.7.4 | Bus, RXD and TXD failure detection | 22 | | | |

continued >>

16 Contact information 68
17 Contents 69

Please be aware that important notices concerning this document and the product(s) described herein, have been included in section 'Legal information'.

© NXP B.V. 2010. All rights reserved.
For more information, please visit: <http://www.nxp.com>
For sales office addresses, please send an email to: salesaddresses@nxp.com
Date of release: 17 March 2010
Document identifier: UJA1066_2