



NXP LPC microcontrollers

Innovation at your fingertips



NXP LPC microcontrollers

Maximize your design potential.
Minimize your design effort.

NXP's LPC microcontrollers are changing the landscape for embedded applications. Equipped with award-winning innovations — in connectivity, design flexibility, integration, packaging, performance, power consumption, security, ease of use, and more — LPC microcontrollers let you maximize the potential of any embedded application.

Today's LPC portfolio, which is divided into five categories and includes more than 325 ARM®-based devices, continues to expand and break new ground. Whether you're looking for a cost-effective upgrade for an existing 8/16-bit design or you're working on a high-end system that needs maximum speed or computational performance, the LPC portfolio has exactly what you need.

LPC portfolio overview

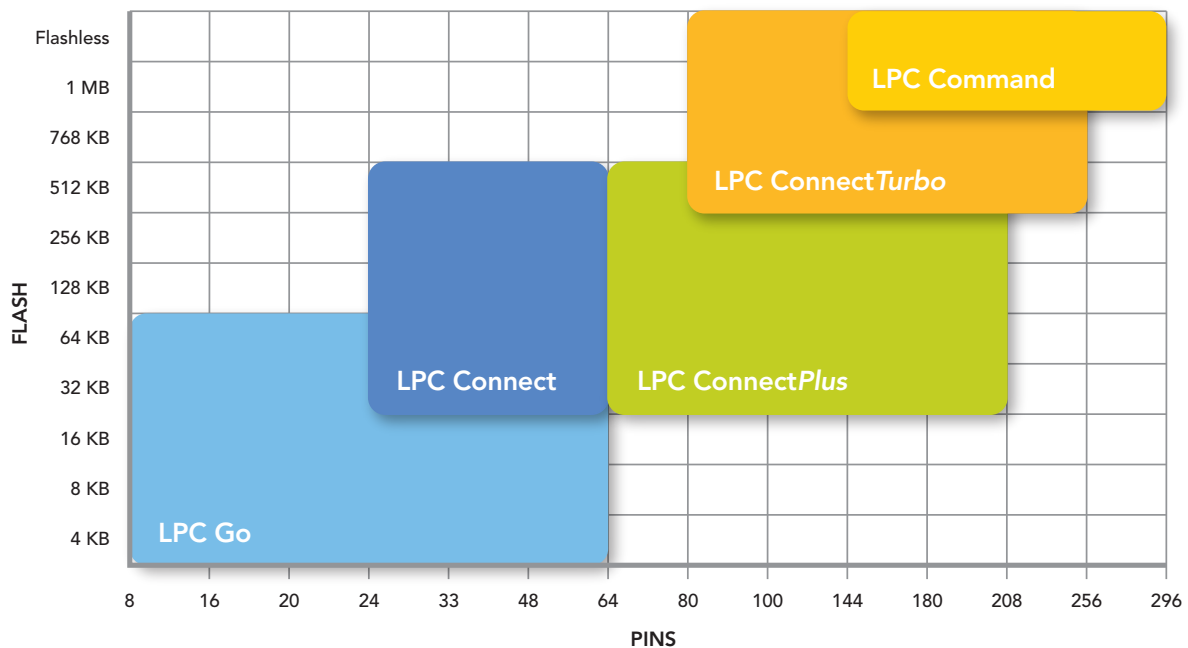

Unmatched functionality

Every NXP LPC microcontroller builds on our well-established, long-term strategic relationship with ARM. We have early access to next-generation IP, so you can be sure you're always working with the latest technologies, and we pack our devices with features you simply won't find anywhere else.

We use the same building blocks in many of our MCUs, and offer pin- and software-compatible options across product families and across cores. That means you have the freedom to add or subtract features, without having to migrate to a new architecture, and you have a flexible way to support your entire product line — now and in the future. With NXP LPC microcontrollers, it's easy to scale and reuse your hardware and software designs, whether you're upgrading or downgrading functionality.





LPC Go

Entry-level microcontrollers

- ▶ 32-bit versatility with 8-bit simplicity
- ▶ Game-changing peripherals
- ▶ Replaces 8/16-bit solutions

LPC800 **LPC11E00**
LPC1100 **LPC131x**
LPC1100LV **LPC210**



LPC Command

Application processors ideal for Linux

- ▶ Application processors
- ▶ High-level OS (Linux)

LPC3100
LPC3200



LPC Connect

Point-to-point connectivity

- ▶ Point-to-point connectivity
- ▶ USB or CAN or segment LCD

LPC11Uxx **LPC134x**
LPC11Cxx **LPC213x**
LPC11A00 **LPC214x**
LPC1200



LPC ConnectPlus

MCU + USB + Ethernet + LCD + ...

- ▶ Faster clock speeds
- ▶ USB + Ethernet + LCD + CAN
- ▶ More integration

LPC4000 **LPC2300**
LPC1700 **LPC2400**
LPC2200



LPC ConnectTurbo

Fastest Cortex-M microcontrollers

- ▶ Fastest clock speeds
- ▶ HS USB, LCD, CAN, and/or Ethernet with DSP instructions
- ▶ Highest level of integration

LPC1800 **LPC2900**
LPC4300

Proven leadership

NXP's LPC portfolio has continually set the standard for performance, integration, and price, and has been recognized, time and again, for its groundbreaking levels of connectivity, power consumption, and ease of use. We were first to add independent bus systems and local bus I/O, first with integrated features like Flash/EEPROM memory, real-time debug, and embedded trace, and first to deliver a market-ready Cortex™-M0 device. Our unique, patent-pending peripherals continue to set us apart, and we're the only supplier to offer a dual-core M4/M0.

LPC Go



NXP's LPC Go microcontrollers feature unprecedented performance, simplicity, and low power consumption. These devices, based on 32-bit ARM cores, are the most cost-effective options compared to 8/16-bit solutions and provide a dramatic reduction in code size for every application. They deliver lower system cost and less power consumption, in an elegant, easy-to-use format that improves time-to-market.

- ▶ Cortex-M0+, Cortex-M0, Cortex-M3, and ARM7-based microcontrollers
- ▶ Best-in-class low-current performance
- ▶ Industry's broadest package selection

LPC Go lines

	LPC800	LPC11xx	LPC11xx in small packages	LPC11xxLV	LPC11Exx	LPC122x	LPC131x	LPC210x
Freq (max)	30 MHz	50 MHz	50 MHz	50 MHz	50 MHz	50 MHz	72 MHz	72 MHz
Flash	Up to 16 KB	Up to 64 KB	Up to 32 KB	Up to 32 KB	Up to 32 KB	Up to 128 KB	Up to 64 KB	Up to 64 KB
RAM	Up to 8 KB	Up to 8 KB	Up to 8 KB	Up to 8 KB	Up to 8 KB	Up to 8 KB	Up to 8 KB	Up to 8 KB
EEPROM					Up to 4 KB		Up to 4 KB	
Core	Cortex-M0+	Cortex-M0	Cortex-M0	Cortex-M0	Cortex-M0	Cortex-M0	Cortex-M3	ARM7TDMI
Analog	Comparator	8/10b ADC	8/10b ADC	8/10b ADC	8/10b ADC	8/10b ADC Comparator	8/10b ADC	8/10b ADC
Package	DIP8 SO20 TSSOP16 TSSOP20	LQFP48 QFN33 QFN24 CSP	SO20 TSSOP20/28 DIP28	CSP QFN24 HVQFN33	LQFP48 LQFP64	LQFP48 LQFP64	HVQFN33 LQFP48 LQFP64	LQFP48 HVQFN48

LPC Go common features

2x 32-bit
timers

2x 16-bit
timers

Power
control

Clock
generation
unit

High-speed
GPIOs

Watchdog
timers

Systick
timer

UART,
I²C, SPI

Up to 8 ch
10-bit ADC

LPC800: Low Power Cortex-M0+

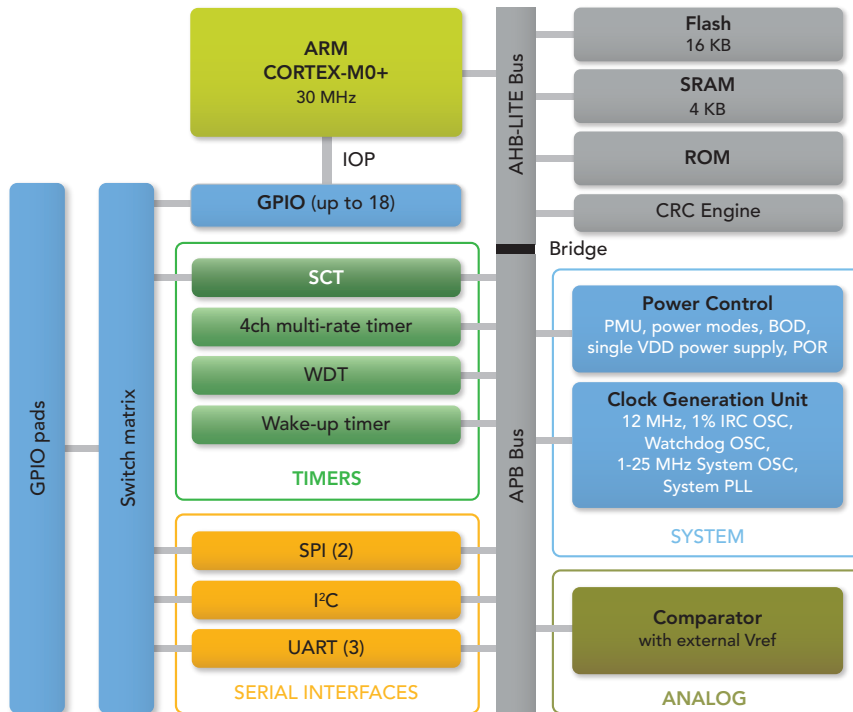

8-bit simplicity,
32-bit versatility,
game-changing
peripherals

Introducing the LPC800

NXP's latest addition to the LPC Go family, the LPC800, promises to change the way you think about embedded design. Offering the simplicity and ease-of-use of 8- and 16-bit devices but with the versatility of a fully-equipped 32-bit architecture, the LPC800 redefines flexibility and scalability. Every peripheral has been redesigned, from the ground up, with the low-cost 8-bit market in mind. That makes the LPC800 series a family of advanced yet cost-effective microcontrollers that are smaller, more streamlined, and more power-efficient than ever.

Features

- ▶ Simple, low-cost Cortex-M0+ processor
 - Full backward compatibility to the Cortex-M0
 - Upwards compatibility with Cortex-M3 and Cortex-M4
 - Performance up to 30 MHz
- ▶ Up to 16 KB Flash / 4 KB SRAM
- ▶ Best energy efficiency due to two-stage pipeline and single-cycle I/O access
- ▶ Easy-to-use, low pin-count TSSOP and DIP packages compatible with M0 devices
- ▶ Flexible switch matrix enabling easy pin configuration — even on the fly
- ▶ Multi-rate timers and State Configurable Timer (SCT) provide advanced timing capabilities

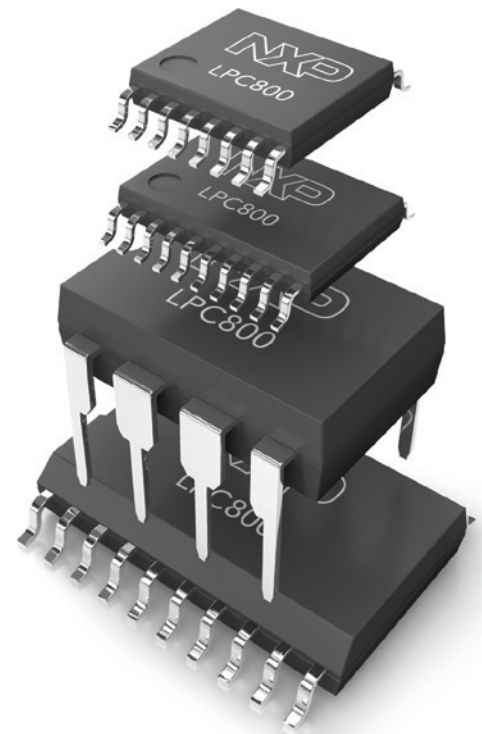

LPC Connect



NXP's LPC Connect microcontrollers add point-to-point connectivity to LPC Go products. LPC Connect devices combine plug-and-play USB or CAN interfaces with software-integrated drivers in on-chip ROM, so it's never been easier to add connectivity to your system. Get to market faster with a connected, efficient, and cost-effective system.

- ▶ Cortex-M0, Cortex-M3, and ARM7-based microcontrollers
- ▶ High performance on standard serial interfaces (SSP, I²C, etc.)
- ▶ Pin-to-pin compatible options for scalable performance
- ▶ Integrated USB 2.0 or CAN 2.0B transceiver
- ▶ USB drivers in ROM: MSC, HID, CDC, DFU
- ▶ CANopen drivers in ROM, programming via CAN

LPC Connect lines

	LPC11Uxx	LPC11Cxx	LPC11Dxx	LPC11Axx	LPC134x	LPC213x	LPC214x
Freq (max)	50 MHz	50 MHz	50 MHz	50 MHz	72 MHz	60 MHz	60 MHz
Flash	16 to 128 KB	16/32 KB	Up to 64 KB	8 to 32 KB	8 to 64 KB	32 to 512 KB	32 to 512 KB
RAM	6 to 12 KB	8 KB	Up to 8 KB	2 to 8 KB	4 to 12 KB	8 to 32 KB	8 to 32 KB
EEPROM	Up to 4 KB			Up to 4 KB	Up to 4 KB		
Core	Cortex-M0	Cortex-M0	Cortex-M0	Cortex-M0	Cortex-M3	ARM7	ARM7
FS USB	•				•		•
CAN		With Tx					
ADC	10-bit	10-bit		10-bit	10 or 12-bit	10-bit	10-bit
Packages	HVQFN33 LQFP48 LQFP64	LQFP48	LQFP100	WLCSP20 HVQFN33 LQFP48	HVQFN33 LQFP48 LQFP64	LQFP64 HVQFN64	LQFP64

LPC Connect common features

2x 32-bit
timers

2x 16-bit
timers

Power
control

High-speed
GPIOs

Watchdog
timer

Systick
timer

UART,
I²C, SPI

8 channel
10-bit ADC

Packages
(CSP, LQFP,
HVQFN)

LPC11U00

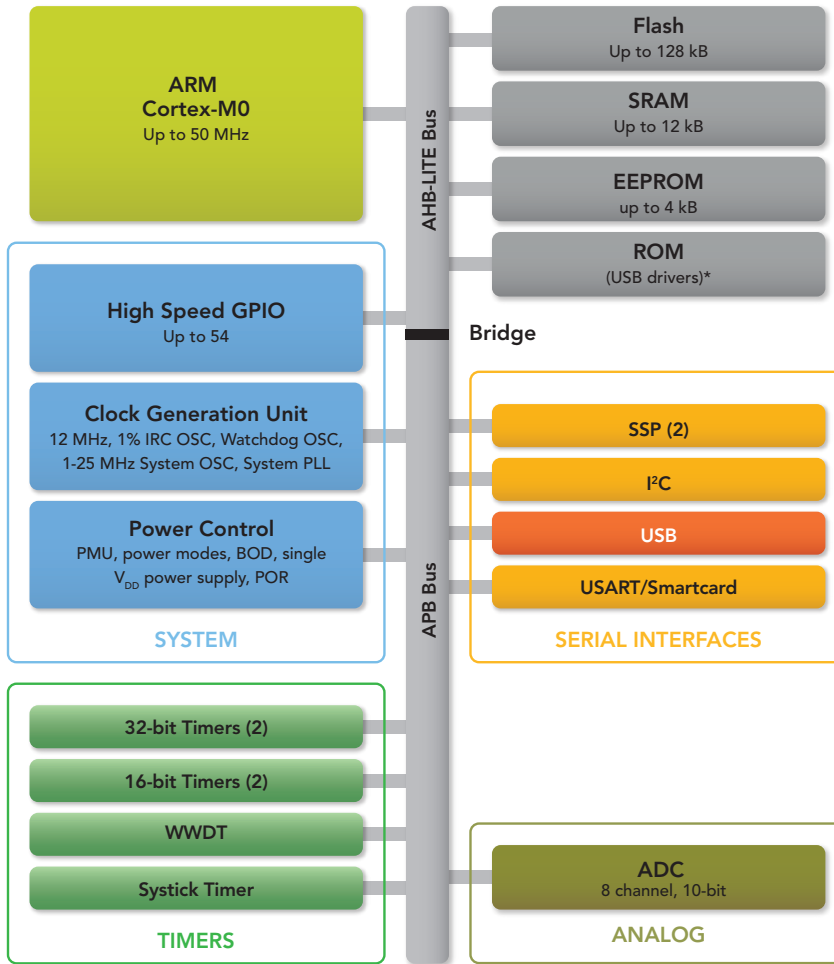

*Applies to LPC11U2x/3x only

It's never been easier to add plug-and-play connectivity to your system design

Featured product LPC11U00

- ▶ Plug-and-play with USB: low-cost, low-power USB Cortex-M0 with integrated EEPROM
- ▶ USB ROM drivers: MSC, HID, CDC, and composite in LPC11U2x/3x
- ▶ Free PID/VID program on LPCware.com
- ▶ Pin-compatible within LPC11U00 series from 16 to 128 kB; and to higher-performance LPC134x



LPC ConnectPlus



NXP's LPC ConnectPlus microcontrollers offer a broad range of interfaces and the bandwidth for running multiple communication protocols simultaneously. Connect to USB plus CAN plus Ethernet plus LCD — and more — all at the same time. LPC ConnectPlus products are available in a wide range of packages, with lots of options for memory and peripherals, and feature pin-compatibility between cores.

- ▶ Cortex-M3, Cortex-M4, and ARM7-based microcontrollers
- ▶ High integration and low power consumption at up to 120 MHz
- ▶ Best-in-class peripheral support: Ethernet, USB 2.0 Host/OTG/Device, CAN 2.0B
- ▶ Memories up to 512 KB Flash
- ▶ Pin compatibility between cores

LPC ConnectPlus lines

	LPC175x/6x	LPC177x/178x	LPC407x/8x	LPC23xx	LPC24xx
Frequency (max)	100/120 MHz	120 MHz	120 MHz	72 MHz	72 MHz
Flash	32 to 512 KB	128 to 512 KB	64 to 512 KB	64 to 512 KB	0/512 KB
RAM	8 to 64 KB	40 to 96 KB	24 to 96 KB	34 to 98 KB	82 to 98 KB
EEPROM		2 to 4 KB	2 to 4 KB		
ADC	12-bit	12-bit	12-bit	10-bit	10-bit
QEI	•	•	•		
SD/MMC		•	•	**	**
USB	•	•	•	•	•
TFT LCD		•	•		•
EMC		•	•	*	•
DSP+FPU			•		
Core	Cortex-M3	Cortex-M3	Cortex-M4	ARM7TDMI	ARM7TDMI

* The LPC2388 has an EMC

** The LPC2367/68/78/87/88 and LPC2460/70/58/68/78 have SD/MMC

LPC ConnectPlus common features

Ethernet
MAC

FS USB
host/
device/OTG

CAN
2.0B

32-bit
timers,
PWMs

RTC,
IRC (1%)

I²S

DAC

UARTS,
I²C,
SPIs

LPC407x/8x

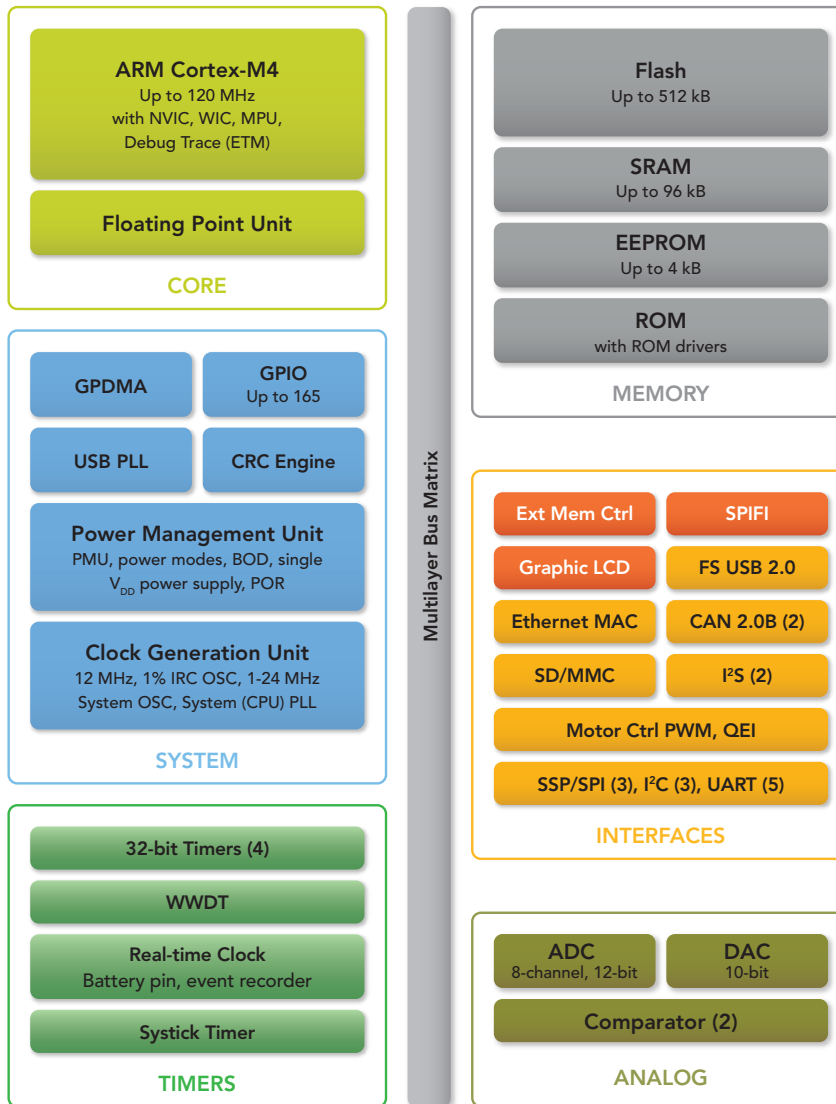

Connect to USB plus
CAN plus Ethernet
plus LCD and more

Featured product

LPC407x/8x

- ▶ Cortex-M4 for LCD Graphics and external memories
- ▶ Adds Cortex-M4, FPU, SPIFI, and two analog comparators to LPC177x/8x parts
- ▶ Packages: BGA208/180 and LQFP208/144
- ▶ Pin-compatible to LPC177x/8x, LPC24xx, and LPC23xx



LPC ConnectTurbo



NXP's LPC Connect*Turbo* microcontrollers are built for speed and include the industry's fastest Cortex-M microcontrollers. This "turbo-charged" performance is combined with advanced peripherals for solving complex design challenges. LPC Connect*Turbo* innovations include Hi-speed USB with integrated Hi-speed PHY, NXP's unique SPI Flash Interface (SPIFI), a State Configurable Timer (SCT), Serial GPIO, and the industry's first dual-core Cortex-M4/M0. All this integration reduces system cost and enables unprecedented embedded performance.

- ▶ Cortex-M3, Cortex-M4, and ARM9-based microcontrollers
- ▶ Up to 204 MHz
- ▶ HS-USB with on-chip PHY + Ethernet + Graphic LCD
- ▶ Unique, asymmetrical dual-core architecture, featuring two ARM processors (LPC4300)
- ▶ State Configurable Timer (SCT) for solving complex timing/PWM challenges
- ▶ Serial GPIO (SGPIO) to increase connectivity
- ▶ Quad SPI Flash Interface (SPIFI) for a low-cost way to expand system Flash

LPC Connect*Turbo* lines

	LPC18x0 Flashless	LPC18xx	LPC43x0 Flashless	LPC4300	LPC2900
Frequency (max)	180 MHz	180 MHz	204 MHz	204 MHz	125 MHz
Flash		512 KB to 1 MB		512 KB to 1 MB	0 to 768 KB
RAM	132 to 200 KB	104 to 136 KB	168 to 264 KB	104 to 136 KB	24 to 56 KB
EEPROM		16 KB		16 KB	16 KB
HS USB	•	•	•	•	
Ethernet	•	•	•	•	
TFT LCD	•	•	•	•	
DSP + FPU			•	•	
SCT, SPIFI	•	•	•	•	
SGPIO			•	•	
Dual Core			•	•	
Core	Cortex-M3	Cortex-M3	Cortex-M4/M0	Cortex-M4/M0	ARM968E-S

LPC Connect*Turbo* common features

Ext bus interface	HS USB H/O/D (up to 2)	Power control	Clock generation unit	High-speed GPIOs	Watchdog timer	Systick timer	UART, I ² C, SPI	CAN (2)
-------------------	------------------------	---------------	-----------------------	------------------	----------------	---------------	-----------------------------	---------

LPC43xx

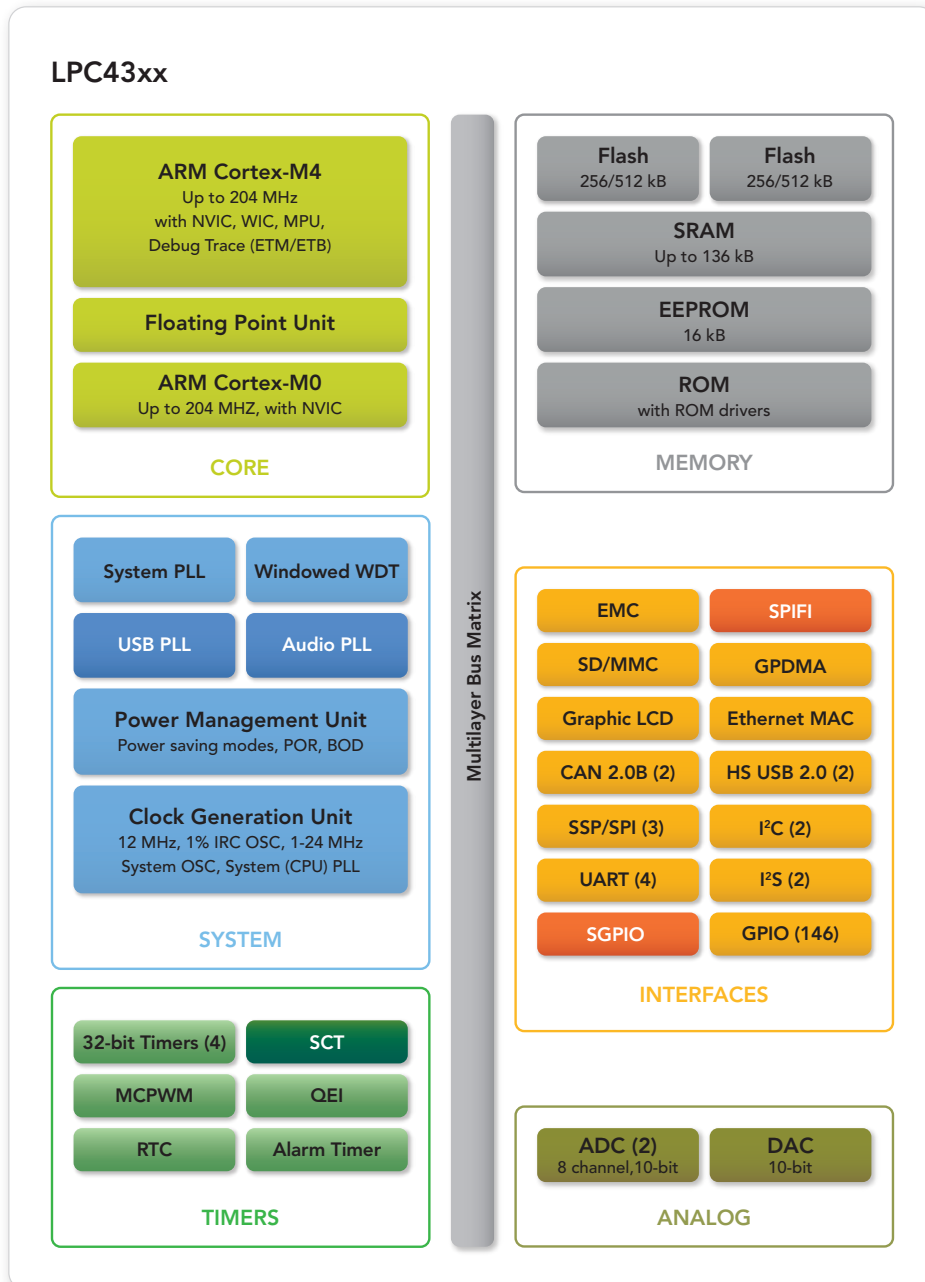

LPC4300: the fastest Cortex-M microcontroller on the planet (204 MHz)

Featured product

LPC43xx

- ▶ Dual-core Cortex-M4/M0 operating at 204 MHz
- ▶ Advanced peripherals: HS USB, Dual Host, on-chip PHY, SCT, SGPIO
- ▶ BGA256/180/100, LQFP208/144
- ▶ Pin-compatible to LPC18xx



LPC Command



NXP's LPC Command application processors provide an ideal and low-cost platform for running the Linux operating system. Based on the ARM9 core, LPC Command products provide an extensive set of peripherals and are designed for general-purpose embedded applications as well as specialty applications, such as high-speed document printers/scanners, industrial control, and motor control.

- ▶ ARM9-based microcontrollers
- ▶ Speeds up to 266 MHz (ARM926 core)
- ▶ Linux support at LPClinux.com

LPC ConnectTurbo lines

	LPC3100	LPC3200
Frequency (max)	270 MHz	266 MHz
SRAM	Up to 192 KB	Up to 256 KB
EMC	SDRAM and SRAM	DDR, SDR SDRAM and static devices
LCD	•	STN or TFT, up to 1024 x 768
HS USB	OTG, Host, Device	OTG, Host, Device
OS support	Linux	Linux
Core	ARM926	ARM926

LPC Command common features

4x 32-bit
timers

SD/MMC

Clock
generation
unit

High-speed
GPIOs

Watchdog
timer

UART,
I²C, SPI

10-bit
4-channel
ADC

LPC3200

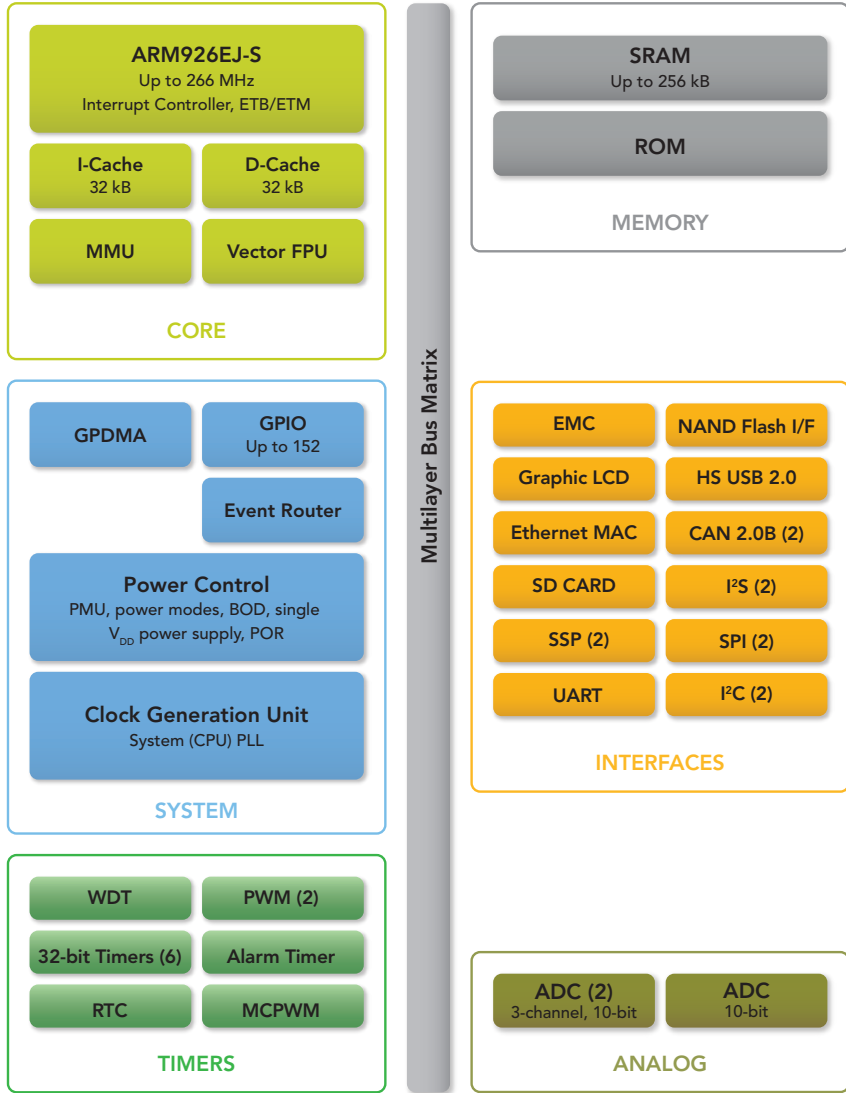

Ideal for running embedded Linux applications

Featured product LPC3200

- ▶ Integrated Ethernet, USB On-The-Go, and LCD controller
- ▶ TBGA296 Package
- ▶ Provides a vector floating-point co-processor
- ▶ Selectable boot-up from NAND Flash, SPI memory, UART, or static memory
- ▶ Clock speeds up to 266 MHz



Unique LPC peripherals

For a simpler, faster, more efficient design

We start with optimized versions of the basic ARM architectures. Then we add special functional and peripheral interfaces that simplify design, improve performance, and save power. The result is a set of features that truly sets us apart.

This section highlights the LPC features available with our Cortex-M devices. For more specific details on the Cortex-M features, or to see the features available with the LPC devices based on ARM7 and ARM9, please refer to our product datasheets.

LPC features available for Cortex-M devices

	LPC Go	LPC Connect	LPC ConnectPlus	LPC ConnectTurbo
SWITCH MATRIX	●			
STATE-CONFIGURABLE TIMER (SCT)	●			●
SPECIAL FUNCTIONS IN ROM	●	●	●	●
USB 2.0 HOST/DEVICE/OTG INTERFACE		●	●	●
CAN 2.0B INTERFACE		●	●	●
ETHERNET INTERFACE			●	●
QUAD SPI FLASH INTERFACE (SPIFI)			●	●
LCD DISPLAY INTERFACE			●	●
SERIAL GPIO (SGPIO)				●
DUAL-CORE (M4/M0) ARCHITECTURE				●



Switch matrix

The flexible switch matrix enables designers to configure on-chip peripherals any way they want. Any peripheral can be assigned to any I/O pin — even on the fly. This creates enormous flexibility in low-pin-count MCUs. What's more, a GUI-based configuration tool makes it fast and easy to build new layouts or edit existing ones.



State-configurable timer (SCT)

This patent-pending peripheral, developed by NXP, is a sophisticated yet easy-to-configure timing function that delivers unprecedented flexibility. The SCT lets you configure a range of timing operations — including those required for complex motor-control functions — while meeting tight development schedules.



Special functions in ROM

Putting special functions in ROM helps increase design flexibility, reduce code size, and simplify development. Options include programming algorithms, API-driven power profiles, USB drivers and USB-compliant stacks for HID, MS, CDC, and DFU classes, peripheral APIs for CAN that include extensible code and CANopen drivers, and an optimized divide library that reduces CPU cycles.



USB 2.0 Host/Device/OTG interface

Nobody gives you more options for fully certified USB functionality. Our USB 2.0 Host/Device/OTG interface includes DMA support and an on-chip high-speed PHY, and supports all four transfer types (control, interrupt, bulk, isochronous). Many of our USB-equipped devices are shipped with the USB device stack and certain class drivers pre-loaded in ROM.



CAN 2.0B interface

We were first to introduce a low-cost entry point for a total Controller Area Network (CAN) solution. The CAN and CANopen drivers are embedded in ROM, so there's more Flash memory for product firmware. The high-performance interface supports bit rates up to 1 Mbit/s and works with multi-drop and serial communications.



Ethernet interface

This full-featured 10/100 MAC supports TCP/IP hardware checksum verification and uses DMA hardware acceleration to improve throughput. It includes RMII and MII interfaces and an external transceiver, and enables low energy consumption with power management features for remote wake-up frame and magic packet detection.



Quad SPI Flash interface (SPIFI)

SPIFI is a patent-pending interface that lets you take full advantage of small, inexpensive serial Flash memories, including Quad SPI Flash. It lets external memory appear in the MCU's memory map, so it can be read like other on-chip memory. That means you can use a standard MCU and cost-effective serial Flash to produce high speeds, save board space, and lower system cost.



LCD display interface

Our optimized LCD display interface drives a wide range of displays without loading the CPU. It provides all the necessary control signals to interface directly with a variety of color and monochrome LCD panels with up to 1024 x 768 pixels, supports hardware cursor for single-panel displays, and offers programmable timing options for different display panels.



Serial GPIO (SGPIO)

Combining general-purpose I/O with a timer/shift register, our SGPIO can be used to create or capture multiple real-time serial data streams. There's no need for code loops that manipulate GPIO in real time, or CPU-intensive "bit banging". For added convenience, SGPIO can also be configured as extra serial interfaces (UART, I²S, I²C, etc.).



Dual-core (M4/M0) architecture

The LPC4300 series is the first to combine a Cortex-M4 with a Cortex-M0. Having two cores on one chip lets you separate the processing and real-time control functions while minimizing PCB space. The M0 core can handle the I/O processing and all the communications functions, including USB and Ethernet, so the M4 core can focus on executing high-performance algorithms.

LPC design tools

Easy, low-cost ways to evaluate, explore, and develop

Our entire Cortex-M portfolio works with a single MCU toolchain, so you can use a familiar set of tools no matter what product or architecture you choose. Plus, because we offer such an extensive range of options — including dedicated tools specially designed for LPC devices — you can be certain you'll always be working with the best.

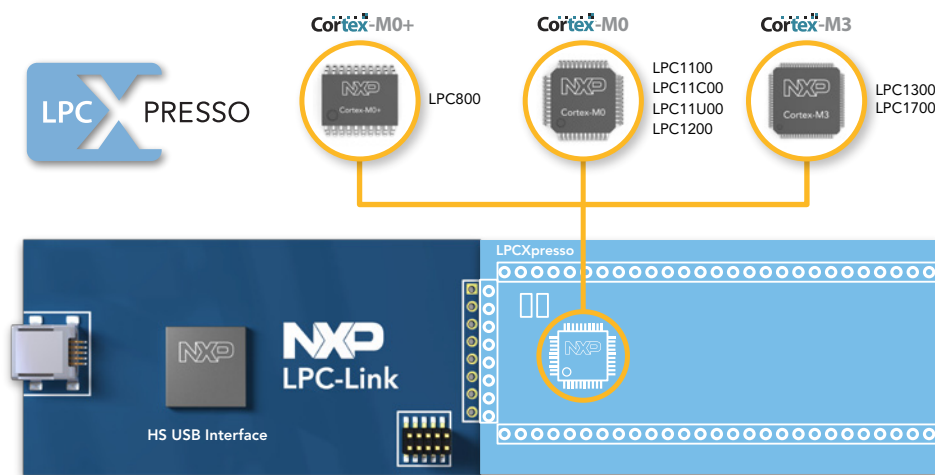

The LPCXpresso development board

LPCXpresso: NXP's unique, low-cost toolchain

This ground-breaking development platform, created by NXP exclusively for our LPC Cortex-M microcontrollers, takes you from evaluation all the way through to production for less than 30 US dollars. LPCXpresso users can evaluate, explore, and develop within a single, easy-to-use interface while retaining all the advanced features associated with powerful and expensive tools.

Designed for simplicity and ease of use, LPCXpresso features a powerful Eclipse-based IDE with a customized interface. Also included are an optimizing compiler with libraries, an LPC-Link JTAG-SWD debug probe, and target boards. Linux and Mac OS X versions are also available. In total, more than 50,000 LPCXpresso boards have already shipped.

LPCXpresso features

- ▶ End-to-end tool for less than US\$30
- ▶ Eclipse-based IDE using very low-cost target boards
- ▶ Target boards come with an integrated JTAG debugger (no need for a separate debug probe)
- ▶ Easy upgrade options to full-blown suites (from Code Red) and hardware kits (from Embedded Artists)

www.nxp.com/lpcxpresso

LPCXpresso IDE

This Eclipse-based software development environment, powered by Code Red, includes all the tools necessary to develop high-quality software solutions in less time and with a lower budget. Along with the latest version of the industry-standard Eclipse GNU toolchain, the IDE includes a proprietary, optimized C library, and can be used to build an executable of any size, with full code optimization.

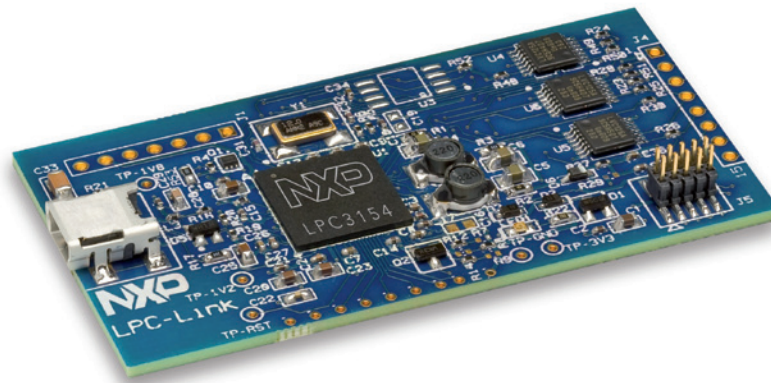

The LPC-Link debugger board

LPCXpresso development boards

Our LPCXpresso target boards, jointly developed by NXP, Code Red, and Embedded Artists, include an integrated JTAG debugger, so there's no need for a separate JTAG debug probe. The target portion of the board can connect to expansion boards for access to a number of interfaces and I/O devices. The on-board JTAG debugger provides a high-speed USB-to-JTAG/SWD interface to the IDE, and it can be connected to other debug targets, including a customer target. The LPCXpresso IDE also works with the Red Probe JTAG adapter from Code Red.

LPC-Link™ debugger board

The JTAG/SWD debugger board, called LPC-Link, is equipped with a 10-pin JTAG header and seamlessly connects to a target via USB. Cutting the traces between the LPC-Link and the target makes the LPC-Link a standalone JTAG debugger, so you can connect the LPCXpresso platform to an external target for use with a wide variety of ARM-based applications.

LPCXpresso support

If you have questions about using an LPCXpresso board, answers are easy to find. We have a dedicated site for LPCXpresso support (www.nxp.com/lpcxpresso-support), and there are more than 5,000 community members on the LPCXpresso forum (www.nxp.com/lpcxpresso-forum), ready to share their tips and expertise.

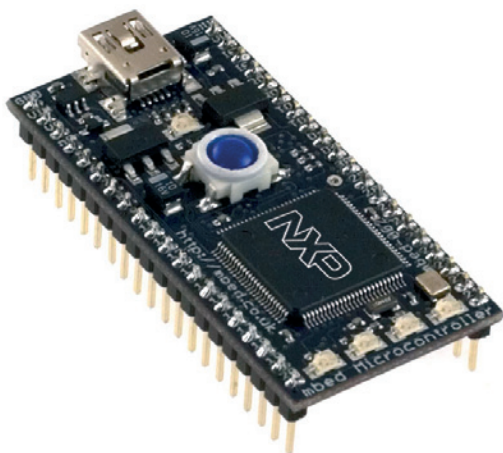

The mbed rapid prototyping tool

Rapid prototyping with mbed

This remarkable online tool, co-developed by NXP and ARM, is the only online rapid prototyping tool for ARM products. It provides a tightly coupled combination of hardware and software, so it's a quick, easy way to try out your latest design ideas. New users can get started in just minutes, and compiling the first program can take as little as 60 seconds. For more information, please visit <http://mbed.org>.

Benefits of mbed

- ▶ Get started right away; there's nothing to install
- ▶ Get working fast, using high-level APIs
- ▶ Explore, test, and demonstrate your ideas more effectively
- ▶ Write clean, compact code that's easy to modify
- ▶ Log in from anywhere, on Windows, Mac, or Linux

mbed

Third-party design tools and free software

An ever-expanding list of best-in-class options

We understand the need to save development time and lower design cost, and we're committed to helping you do both.

All of NXP's LPC microcontrollers are supported by a well established — and rapidly growing — network of third-party tool suppliers. As an LPC designer, you have direct access to a very wide set of tools, from more than 80 companies, that help you save time while optimizing your design.

We've partnered with some of the best names in development tools — including Keil and IAR, as well as Code Red, Embedded Artists, Hitex, and NGX — and have options for everything from evaluation boards and software development toolchains to debuggers, RTOSs, software stacks, file systems, programming tools, and more.

Many of these items are available at very low cost or for free, so you can save on more than just design time, too. For a complete list of tools available for LPC devices, please visit www.nxp.com/microcontrollers.

A sampling of third-party tools available for LPC microcontrollers

	Development tools	JTAG debug tools	Evaluation boards	RTOS/middleware
	●	●	●	
	●	●	●	●
	●	●	●	
		●		●
				●
				●
			●	
			●	
		●	●	



Free LPC software

Our customers get full access to a range of software options for optimizing USB, Ethernet, and LCD interfaces, and more. The software is free to download, free to build with, and free to use, so delivering a full-featured system has never been cheaper — or easier. www.lpcware.com



Free USB libraries: nxpUSBlib

This full-featured, open-source USB library is designed to run on all our USB-capable LPC microcontrollers. It supports Host (OHCI and EHCI) and device modes, works with all three USB transfer rates (low-, full-, and high-speed), and supports all four transfer types (control, bulk, interrupt, and isochronous).

www.lpcware.com/content/project/nxpusplib



Free USB VID/PID assignments

Our USB VID program lets you apply for an NXP vendor ID (VID) and get up to three product IDs (PIDs) for free. The program works with all our LPC11U1x, LPC11U2x, and LPC11U3x devices. Just download the application, fill it out, and send it back to us, and you're ready to go. There's no need to be a member of the USB-IF.

www.lpcware.com/content/project/usb-vid-pid-program



Free lightweight IP (LWIP) networking stack

This stack provides low-level networking support and is ideal for networking applications that require a low memory footprint. The NXP LWIP port supports standalone (raw API) and threaded (FreeRTOS) configuration, and the stack is supported by free-to-access online documentation and benchmarks.

www.lpcware.com/content/project/lightweight-ip-lwip-networking-stack



Free graphics libraries

When you use an LPC microcontroller equipped with an LCD interface, you get free access to emWin by Segger, a robust, efficient GUI for any application operating with a graphical LCD. We also give you free access to Simple Windows Interface Manager (SWIM), a basic graphics library with very low overhead requirements.

www.lpcware.com/content/project/emwin-graphics-library



When you choose NXP as your design partner, you become part of an international community of developers ready to share their experiences and expertise whenever you need it.

Online communities and more



LPCZone

This online community, dedicated to developers of LPC microcontrollers, is design central for all things LPC. This is where you'll find the latest videos on LPC products and tools, and full training sessions presented at industry trade shows.

www.nxp.com/lpczone



LPCXpresso

This forum, with over 1,000 active members, has hundreds of useful threads, all dedicated to tips, tricks, and insider expertise on the LPCXpresso development platform.

<http://knowledgebase.nxp.com/>



YouTube

An extension of the LPCZone, this YouTube site is an extensive resource for technical tutorials, news items, interviews, design challenges, and more.

www.youtube.com/user/LPCZone



Yahoo! forum

With roughly 10,000 registered members, NXP's LPC forum is the #1 active microcontroller forum on Yahoo!

<http://tech.groups.yahoo.com/group/lpc2000/>



Twitter

Follow the LPCZone for the most up-to-date information on all of NXP's LPC product families.

<http://twitter.com/LPCZone>



LPCware

This NXP-sponsored technical site is for engineers interested in all things LPC. Connect with other designers or find resources for getting you up and running with new hardware, including tutorials, software and driver packages, schematics, tools, FAQs, design tips, and more.

www.lpcware.com

Other useful links

NXP's dedicated web pages make it easy to find whatever you need. Use the links below to review product data, get help with a design, sign up for a training seminar, find your nearest distributor, and more.

LPC microcontroller microsite

www.nxp.com/products/microcontrollers

LPC microcontroller off-line selector guide

www.lpcware.com/content/nxpfile/nxp-line-product-selector

NXP technical support portal

(application notes, datasheets, user manuals, sales literature, models, and more)

www.nxp.com/technical-support-portal.html

NXP sales offices & distributors

www.nxp.com/about/sales-offices-distributors.html

e-Learning modules

http://elearning.nxp.com/course/category.php?id_28

Handbook library

<http://ics.nxp.com/literature/?type+book>

Microcontroller community website

www.microcontrollercentral.com

Building on the ARM foundation

NXP is committed to the ARM architecture for several reasons. For starters, ARM accounts for roughly 90% of all embedded 32-bit RISC processors, so it makes sense to support the architecture designers trust most.

Performance and power play a role, too, since processing speed and energy efficiency are so essential to today's designs. The ARM RISC architecture executes quickly, and requires fewer clock cycles to perform a given task, so the system runs faster. ARM architectures also deliver a higher amount of processing power for a given amount of electricity, so the system delivers higher efficiency and cooler operating temperatures.

ARM has developed low-cost cores that compete directly with 8/16-bit options, so designers can upgrade their systems to higher performance and greater functionality, while staying on budget. Also, the very high level of integration possible with every ARM architecture means the design needs fewer external components, and that can save on overall cost.

Ecosystem is another reason to choose ARM. There are more than 750 ARM partners, delivering silicon, tools, and software, so designers can select from an incredibly wide range of development tools, and can easily enlist the support of specialized third-party experts.

Do all ARM licensees offer the same products?

The short answer is no. Every licensee starts with the same basic core structure from ARM, but there's a certain degree of freedom in how to implement the overall device. Licensees can keep certain features, discard others, or add their own special functions. Those decisions can have a big impact on performance, power consumption, and feature set, so it's important to look beyond the ARM core and evaluate the specific implementation.



NXP microcontrollers award-winning ideas

2003	2005	2007	2008	2009	2010					
 <p>EDN HOT 100 Products LPC213x</p>	 <p>EDN HOT 100 Products LPC210x</p>	 <p>Elektronik Produkt des Jahres 2005 LPC210x</p>	 <p>EDN Innovation Award LPC24xx</p>	 <p>EEPW China Embedded Systems New Technology Award LPC3200</p>	 <p>EDN China Innovation Award LPC1700</p>	 <p>21ic China Product of the Year LPC1100</p>	 <p>EEPW China Best Series LPC1700</p>	 <p>EDN China Innovation Award LPC1102</p>	 <p>EEPW China Best 32-bit Microcontroller LPC1759/69</p>	 <p>Electronic Design Best Electronic Design in Digital LPC4000</p>
 <p>China ACE Award Digital Product of the Year LPC4000</p>	 <p>21ic China Product of the Year LPC4000</p>	 <p>EDN Innovation Award EM773</p>	 <p>CEN Best MCU Solution for Industrial Design LPC11C00</p>	 <p>EDN HOT 100 Products LPC11U00</p>	 <p>EDN Leading Product Award LPC1800</p>	 <p>Elektronik Produkte des Jahres 2012</p>	 <p>EETimes/EDN ACE Award Digital ICs Ultimate Product LPC11U00</p>			



www.nxp.com

© 2012 NXP B.V.

All rights reserved. Reproduction in whole or in part is prohibited without the prior written consent of the copyright owner. The information presented in this document does not form part of any quotation or contract, is believed to be accurate and reliable and may be changed without notice. No liability will be accepted by the publisher for any consequence of its use. Publication thereof does not convey nor imply any license under patent or other industrial or intellectual property rights.

Date of release: November 2012
Published in the USA