

500mA Power Distribution Switch

FEATURES

- 120mΩ (5V Input) High-Side MOSFET Switch.
- 500mA Continuous Load Current.
- 80μA Typical On-State Supply Current.
- 1μA Typical Off-State Supply Current.
- Current-Limit / Short Circuit Protection.
- Thermal Limiting Protection under Overcurrent Condition.
- Output can be Forced Higher than Input (Off-State).
- Active-High or Active-Low Enable.

APPLICATIONS

- Power Management.
- PCI Cards With Wake-On- LAN
- Hot Plug-In Power Supplies.
- Power Distribution Switch.

DESCRIPTION

The AIC1523 is an integrated high-side power switches for input power selection applications that using in portable products or PCI interface peripheral cards. The high-side switch is a MOSFET with 120mΩ $R_{DS(ON)}$, low voltage drop and low power consumption meet power saving requirements . The switch ON/OFF is controlled by CTL pin.

Output current is typically limited to 1.0A, well below the 5A safety requirement, and thermal shutdown function shuts the switch off to prevent damage under overcurrent conditions.

Design easily and layout flexibility for getting stable voltage in power transfer transition for power selection application. Guaranteed minimum output rise time limits inrush current during hot plug-in, minimizing EMI and preventing the voltage at upstream port from dropping excessively.

TYPICAL APPLICATION CIRCUIT

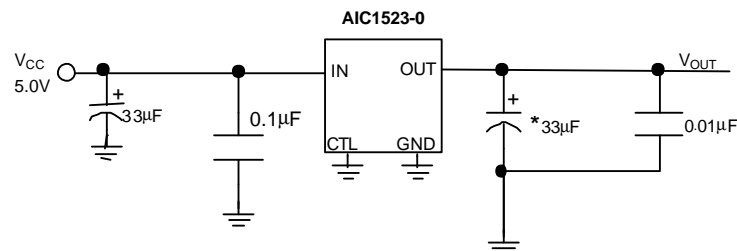

* 33μF, 16V Tantalum, or
100μF, 10V Electrolytic
Bold line indicate high-current traces

High-Side Power Distribution Switch

ORDERING INFORMATION

AIC1523-XCX

PACKAGING TYPE
 O: MSOP
 S: SO8

CONTROL POLARITY
 0: Active Low
 1: Active High

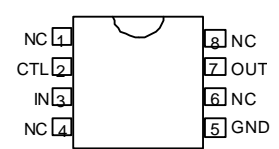
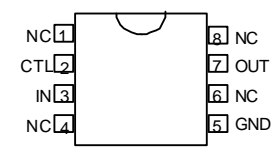
| ORDER NUMBER | PIN CONFIGURATION |
|---------------------------------------|---|
| AIC1523-0CO AIC1523-1CO (MSOP8) | FRONT VIEW  |
| AIC1523-0CS AIC1523-1CS (SO8) | FRONT VIEW  |

ABSOLUTE MAXIMUM RATINGS

Supply Voltage (V_{IN}) 7.0V

Operating Temperature Range -40°C ~ 85°C

Storage Temperature Range -65°C ~ 150°C

ELECTRICAL CHARACTERISTICS ($V_{IN}=5V$, $T_a=25^\circ C$, unless otherwise specified.)

| PARAMETERS | CONDITIONS | MIN. | TYP. | MAX. | UNIT |
|---------------------------|----------------------|------|------|------|-----------|
| Supply Current | Switch Off, OUT=Open | | 0.75 | 2 | μA |
| | Switch On, OUT=Open | | 80 | 100 | |
| Control Input Voltage | V_{CTL} =Logic "0" | | | 0.8 | V |
| | V_{CTL} =Logic "1" | 2.4 | | | |
| Control Input Current | V_{CTL} =Logic "0" | | 0.01 | 1 | μA |
| | V_{CTL} =Logic "1" | | 0.01 | 1 | |
| Output MOSFET Resistance | $I_{OUT} = 500mA$ | | 120 | 180 | $m\Omega$ |
| Output Turn-On Rise Delay | $R_L = 10\Omega$ | | 30 | | μS |
| Output Turn-On Rise Time | $R_L = 10\Omega$ | | 500 | | μS |
| Output Turn-Off Delay | $R_L = 10\Omega$ | | 0.2 | 10 | μS |

ELECTRICAL CHARACTERISTICS (Continued)

| PARAMETERS | CONDITIONS | MIN. | TYP. | MAX. | UNIT |
|---------------------------|------------------------|------|------|------|--------------------|
| Output Turn-Off Fall Time | $R_L = 10\Omega$ | | 0.2 | 10 | μS |
| Output Leakage Current | | | | 2 | μA |
| Current Limit Threshold | $V_{in} = 5.0\text{V}$ | 0.6 | 1.0 | 1.25 | A |
| Current Limit Threshold | $V_{in} = 2.4\text{V}$ | 0.6 | | | A |
| Thermal Limit | | | 110 | | $^{\circ}\text{C}$ |

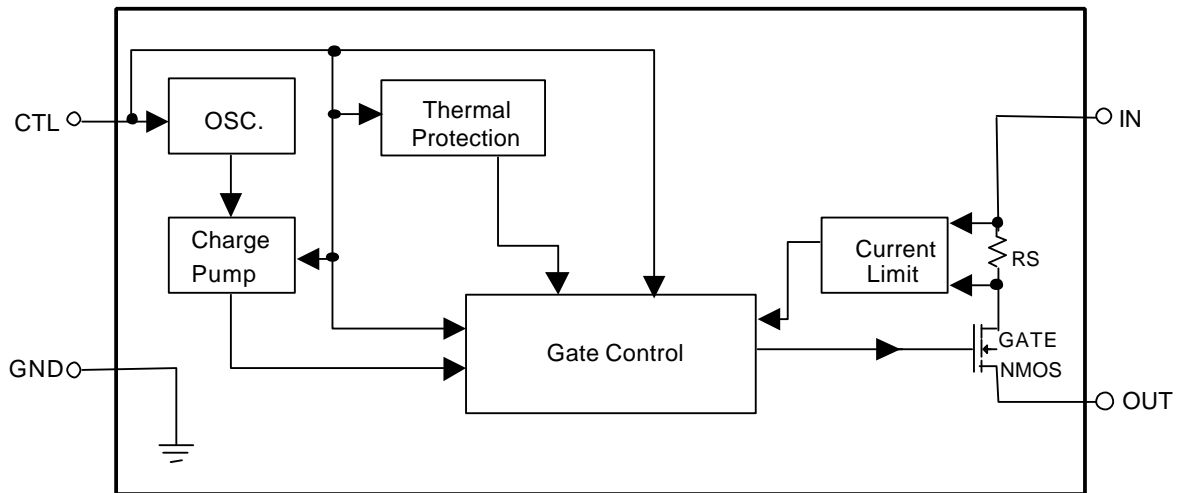
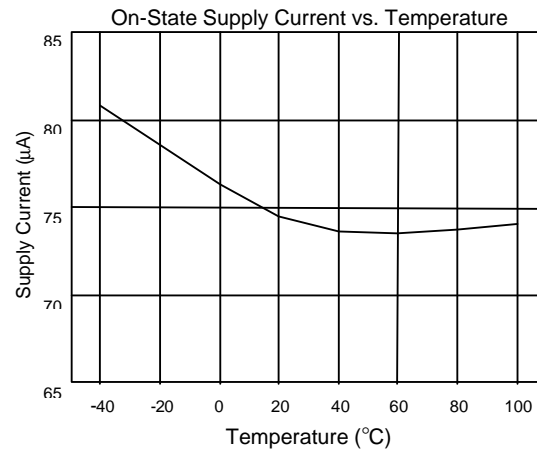
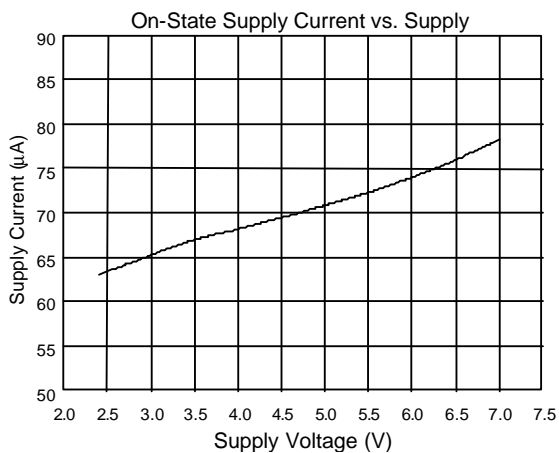
BLOCK DIAGRAM

TYPICAL PERFORMANCE CHARACTERISTICS

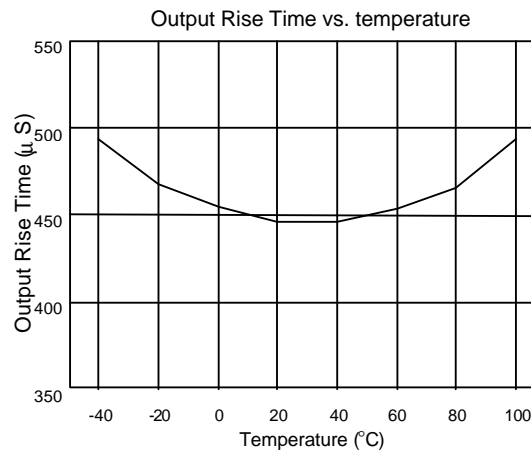
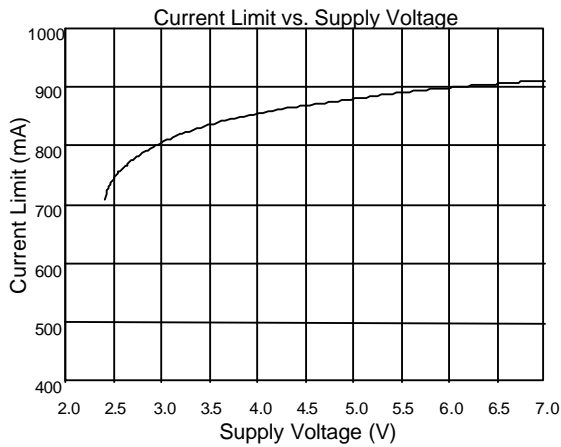
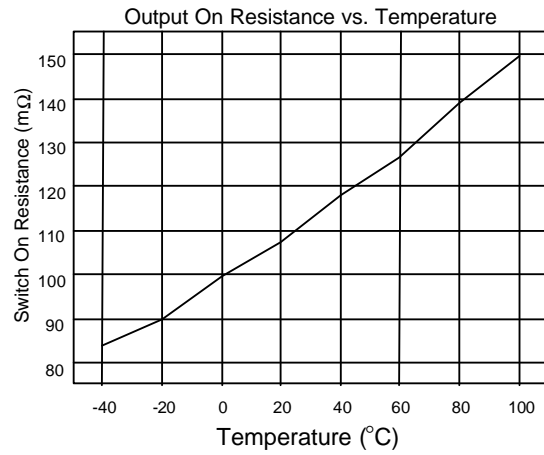
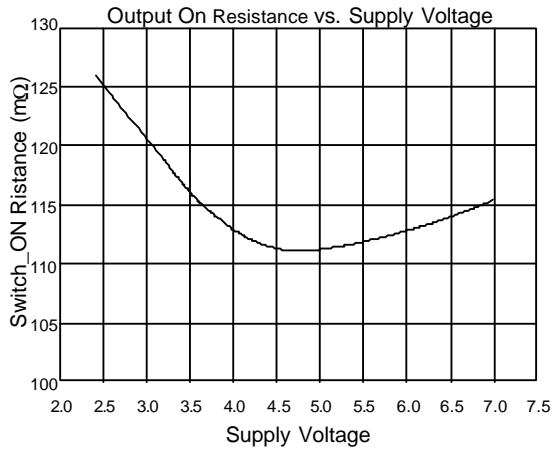
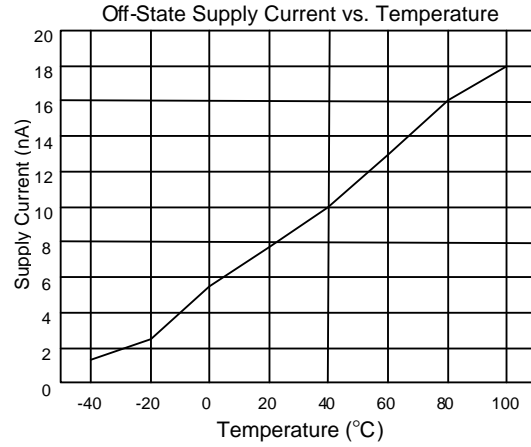
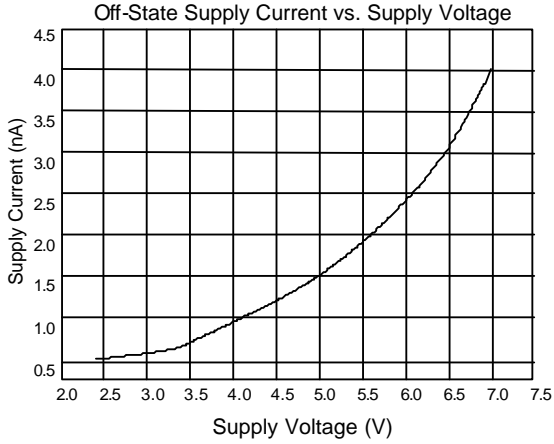
TYPICAL PERFORMANCE CHARACTERISTICS (Continued)

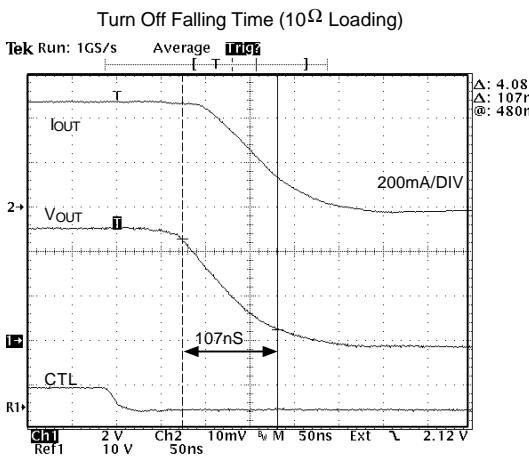
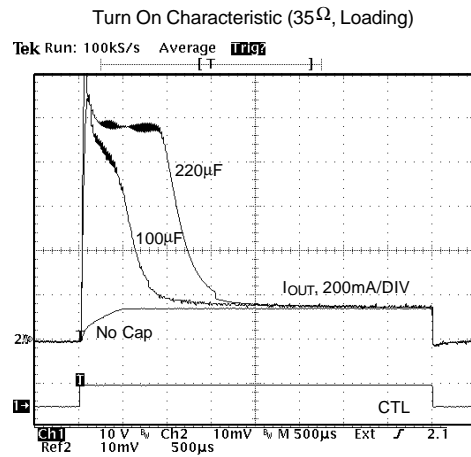
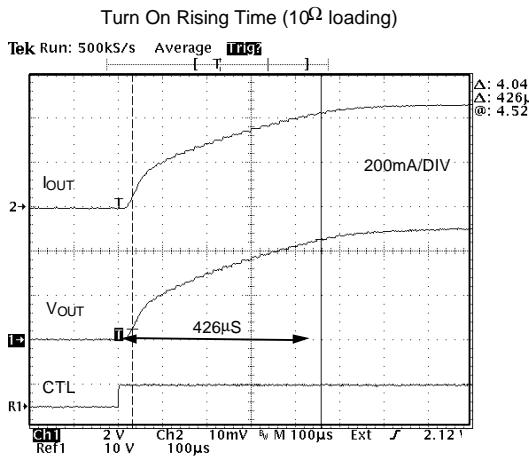
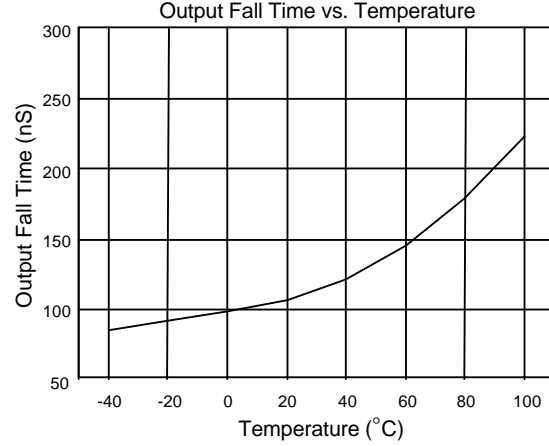
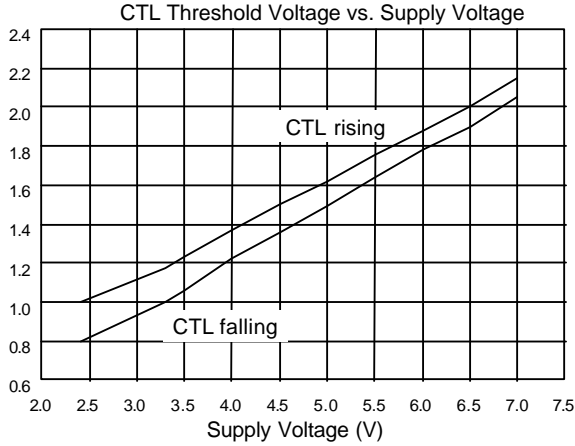

TYPICAL PERFORMANCE CHARACTERISTICS (Continued)



TYPICAL PERFORMANCE CHARACTERISTICS (Continued)

Turn On Characteristic (35Ω, 100μF Loading)

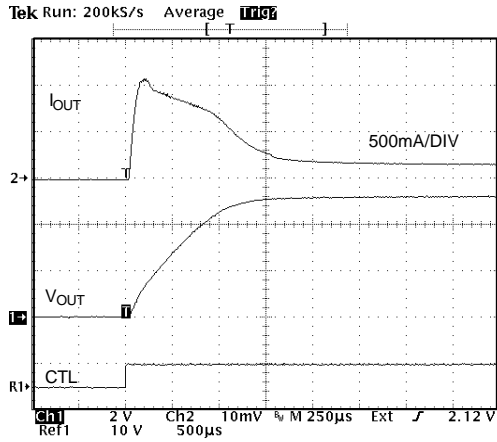

Turn Off Falling Time (35Ω, 100uF Loading)

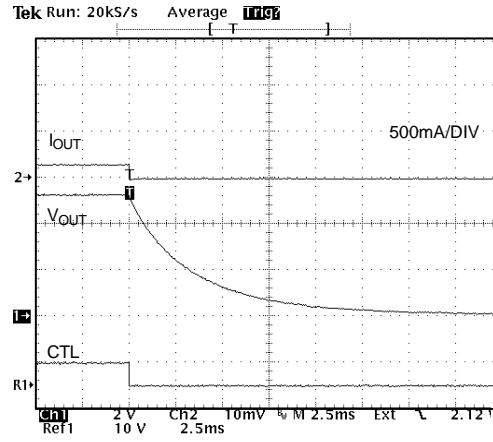

Current Limit Threshold

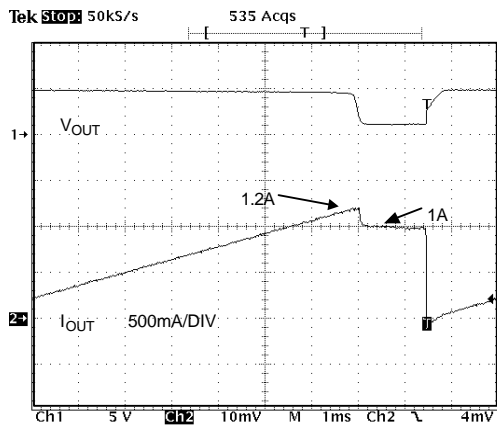

Thermal Limiting Transient Response

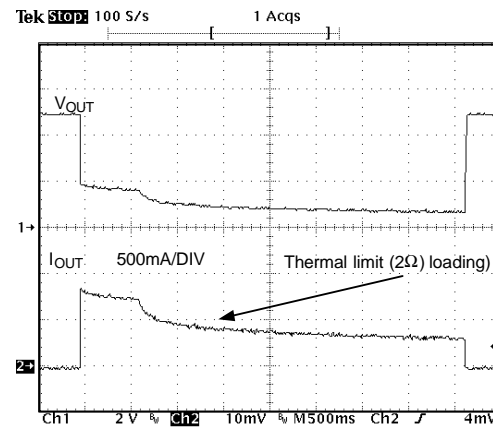

Short Circuit Testing

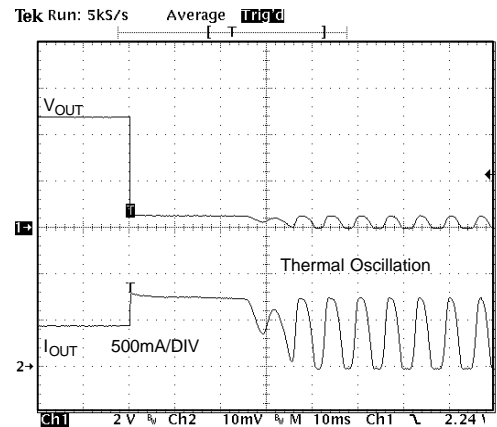

Short Circuit Response Time

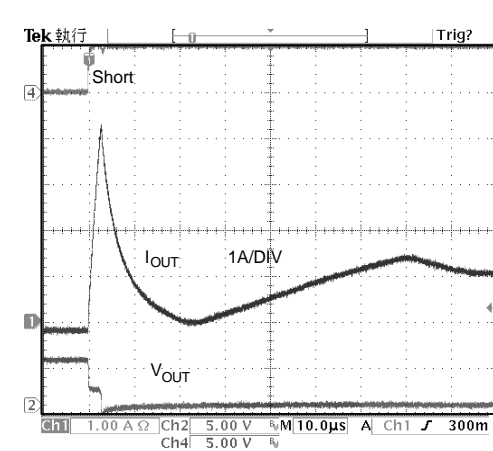

■ PIN DESCRIPTION

PIN 1/4/6/8: NC:

PIN 2: CTL - TTL compatible control input. It controls the power switch turn-on/turn-off. Active High for AIC1523-1 and active low for AIC1523-0.

PIN 3: IN- Power supply input.

PIN 4: GND- Chip power ground.

PN 7: OUT- MOSFET switch output.

■ APPLICATION INFORMATIONS

● Current Limit

- The current limit threshold is preset internally. It protects the output MOSFET switches from damage due to undesirable short circuit conditions or excess inrush current often encountered during hot plug-in. The AIC1523 allows minimum 500mA continuous load current per Channel.

● Thermal Protection

When the chip temperature exceeds 110°C, the thermal protection function works.

● Supply Filtering

A 0.1uF to 1uF bypass capacitor from IN to GND, located near the device, is strongly recommended to control supply transients. Without a bypass capacitor, an output short may cause sufficient ringing on the input (from supply lead inductance) to damage internal control circuitry.

● Transient Droop Requirements

A current surge is caused by the input capacitance of device. Ferrite beads are recommended in series with all power and ground connector pins. Ferrite beads reduce EMI and limit the inrush current during hot-attachment by filtering high-frequency signals.

● Short Circuit Transient

Bulk capacitance provides the short-term transient current needed during a hot-attachment event. With a 33uF, 16V tantalum or 100uF, 10V electrolytic capacitor mounted close to downstream connector should provide transient drop protection.

● Printed Circuit Layout

The power circuitry of printed circuit boards requires a customized layout to maximize thermal dissipation and to minimize voltage drop and EMI.

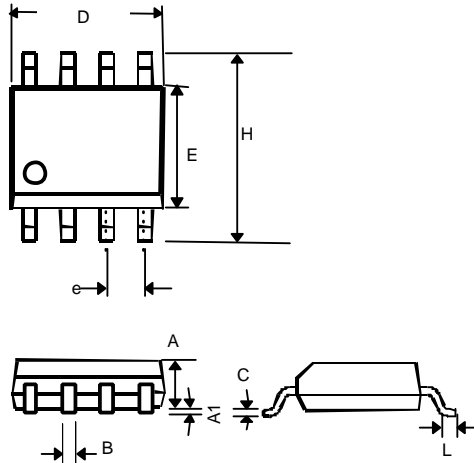
PHYSICAL DIMENSIONS
● MSOP 8 (unit: mm)

| SYMBOL | MIN | MAX |
|--------|------|------|
| A | 0.76 | 0.97 |
| A1 | -- | 0.20 |
| B | 0.28 | 0.38 |
| C | 0.13 | 0.23 |
| D | 2.90 | 3.10 |
| E | 2.90 | 3.10 |
| e | 0.65 | |
| H | 4.80 | 5.00 |
| L | 0.40 | 0.66 |

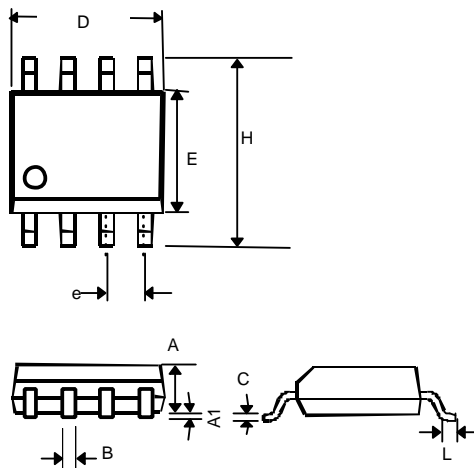
● 8 LEAD PLASTIC SO (unit: mm)

| SYMBOL | MIN | MAX |
|--------|-----------|------|
| A | 1.35 | 1.75 |
| A1 | 0.10 | 0.25 |
| B | 0.33 | 0.51 |
| C | 0.19 | 0.25 |
| D | 4.80 | 5.00 |
| E | 3.80 | 4.00 |
| e | 1.27(TYP) | |
| H | 5.80 | 6.20 |
| L | 0.40 | 1.27 |